

BL/SL 3.50 series
BL 3.50/06/270 SN BK BX
Weidmüller Interface GmbH & Co. KG

Klingenbergstraße 16

D-32758 Detmold

Germany

Fon: +49 5231 14-0

Fax: +49 5231 14-2083

www.weidmueller.com

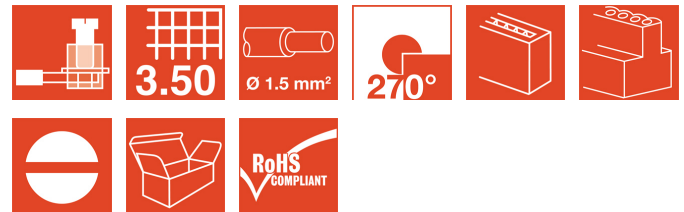

Female connectors with clamping yoke screw system for connecting conductors at 3.50 mm pitch. They include space for labelling and can be coded.

- 0.20 - 1.5 mm² (IEC) / 28 - 14 AWG (UL)
- 250 V (IEC) / 300 V (UL)
- 17 A (IEC) / 10 A (UL)

General ordering data

Order No.	1639740000
Type	BL 3.50/06/270 SN BK BX
Version	PCB plug-in connector, female plug, 3.50 mm, No. of poles: 6, 270°, Clamping yoke connection, Clamping range, rated connection, max.: 1.5 mm ² , Box
Product data	IEC: 320 V / 12 A / 0.2 - 1.5 mm ² UL: 300 V / 8 A / AWG 28 - AWG 14
GTIN (EAN)	4008190277291
Qty.	50 pc(s).
Packaging	Box

Creation date March 14, 2012 6:22:37 AM CET

BL/SL 3.50 series
BL 3.50/06/270 SN BK BX

Weidmüller Interface GmbH & Co. KG
 Klingenbergstraße 16
 D-32758 Detmold
 Germany
 Fon: +49 5231 14-0
 Fax: +49 5231 14-2083
 www.weidmueller.com

Technical data**System parameters**

Product family	BL/SL 3.50 series	Conductor connection system	Clamping yoke connection
Outgoing direction of conductor	270°	Pitch in mm (P)	3.5 mm
Pitch in inches (P)	0.138 inch	No. of poles	6
Number of rows	1	Screwdriver blade	0.4 x 2.5
Screwdriver blade standard	DIN 5264	Tightening torque, min.	0.2 Nm
Tightening torque, max.	0.25 Nm	Clamping screw	M 2
Stripping length	6 mm	L1 in mm	17.5 mm
L1 in inches	0.689 inch	Touch-safe protection acc. to DIN VDE 0470 IP 20	
Touch-safe protection acc. to DIN VDE 57 106	Safe from finger touch		

Material data

Insulating material	PBT	Colour	Black
Colour chart	Similar to RAL 9011	Flammability class UL 94	V-0
CTI	≥ 200	Contact material	Copper alloy
Contact surface	tinned	Continuous operating temp., min.	-25 °C
Continuous operating temp., max.	100 °C		

Connectable conductors

Clamping range, rated connection, min.	0.08 mm ²	Clamping range, rated connection, max.	1.5 mm ²
Wire connection cross section AWG, min.	AWG 14	Wire connection cross section AWG, max.	AWG 28
Solid, min. H05(07) V-U	0.2 mm ²	Solid, max. H05(07) V-U	1.5 mm ²
Flexible, min. H05(07) V-K	0.2 mm ²	Flexible, max. H05(07) V-K	1.5 mm ²
w. wire end ferrule, DIN 46228 pt 1, min.	0.2 mm ²	w. wire end ferrule, DIN 46228 pt 1, max.	1.5 mm ²
w. plastic collar ferrule, DIN 46228 pt 4, min.	0.2 mm ²	w. plastic collar ferrule, DIN 46228 pt 4, max.	1.5 mm ²
Plug gauge acc. to EN 60999 a x b; ø	2.4 mm x 1.5 mm		

DIN IEC rating data

Rated current, min. no. of poles (Tu=20°C)	12 A	Rated current, max. no. of poles (Tu=20°C)	10 A
Rated current, number of poles (Tu=40°C), min.	10 A	Rated current, number of poles (Tu=40°C), max.	8 A
Rated voltage for surge voltage class / pollution degree II/2	320 V	Rated voltage for surge voltage class / pollution degree III/2	160 V
Rated voltage for surge voltage class / pollution degree III/3	160 V	Rated impulse voltage for surge voltage class/ pollution degree II/2	2.5 kV
Rated impulse voltage for surge voltage class/ pollution degree III/2	2.5 kV	Rated impulse voltage for surge voltage class/ contamination degree III/3	2.5 kV
Short-time withstand current resistance	3 x 1s with 100 A		

CSA rating data

Institute (CSA)		Rated voltage (Use group B)	300 V
Rated current (use group B)	10 A	Rated voltage (use group D)	300 V
Rated current (use group D)	10 A	Wire cross-section, AWG, min.	AWG 28
Wire cross-section, AWG, max.	AWG 14		

**BL/SL 3.50 series
BL 3.50/06/270 SN BK BX**

Weidmüller Interface GmbH & Co. KG
Klingenbergstraße 16
D-32758 Detmold
Germany
Fon: +49 5231 14-0
Fax: +49 5231 14-2083
www.weidmueller.com

Technical data

UL 1059 rating data

Rated voltage (use group B)	300 V	Rated current (use group B)	8 A
Rated voltage (use group D)	300 V	Rated current (use group D)	8 A
Wire cross-section, AWG, min.	AWG 28	Wire cross-section, AWG, max.	AWG 14

Classifications

ETIM 3.0	EC001284	ETIM 4.0	EC002637
UNSPSC	30-21-18-10	eClass 4.1	27-26-07-01
eClass 5.1	27-26-07-04	eClass 6.0	27-26-07-04
eClass 7.0	27-44-04-02		

Notes

- Notes
- Additional colours on request
 - Gold-plated contact surfaces on request
 - Rated current related to rated cross-section and min. No. of poles.
 - Max. O.D. of conductor: 2.9 mm
 - Wire end ferrule without plastic collar to DIN 46228/1
 - Wire end ferrule with plastic collar to DIN 46228/4
 - P on drg. = pitch
 - Rated data refer only to the component itself. Clearance and creepage distances to other components are to be designed in accordance with the relevant application standards.

Approvals

Approvals



**BL/SL 3.50 series
BL 3.50/06/270 SN BK BX**

Weidmüller Interface GmbH & Co. KG
 Klingenbergstraße 16
 D-32758 Detmold
 Germany
 Fon: +49 5231 14-0
 Fax: +49 5231 14-2083
 www.weidmueller.com

Drawings

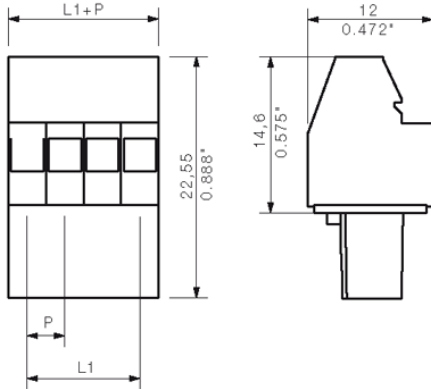

BL 3.50/.. /90 & /270 - SL 3.50/.. /90

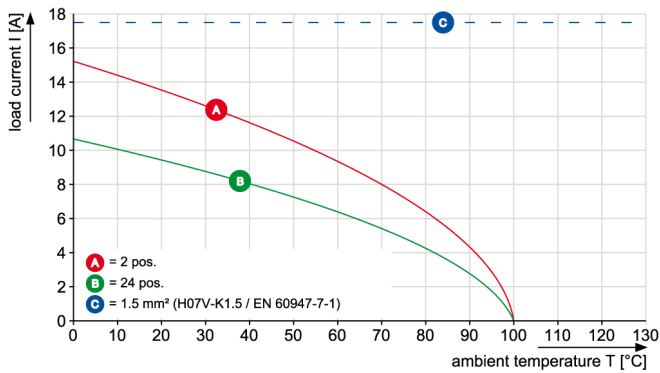

BL 3.50/.. /90 & /270 - SL 3.50/.. /90

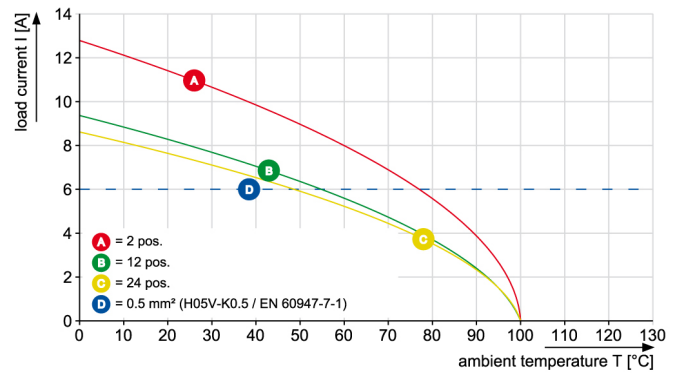

**BL/SL 3.50 series
BL 3.50/06/270 SN BK BX**

Weidmüller Interface GmbH & Co. KG
 Klingenbergstraße 16
 D-32758 Detmold
 Germany
 Fon: +49 5231 14-0
 Fax: +49 5231 14-2083
 www.weidmueller.com

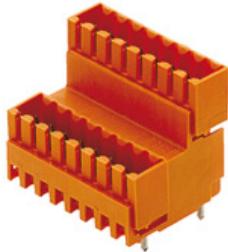
Mating connector (fully pluggable)
SLD 3.5V/180G

Two-tier offset male connector for wave soldering, with 3.50 mm pitch The male connector is available in closed and flange versions. The male connectors provide space for labelling and can be coded.

- 250 V (IEC) / 300 V (UL)
- 10.5 A (IEC) / 8 A (UL)

General ordering data

Order No.	Type	Version	Product data	GTIN (EAN)	Qty.	Packaging
1641130000	SLD 3.5 V/12/180G 3.2OR	PCB plug-in connector, male header, closed side, Solder connection, 3.50 mm, No. of poles: 12, 180°, Solder pin length (l): 3.2 mm, tinned, Orange, Box	IEC: 200 V / 10.5 A UL: 300 V / 8 A	4008190279530	50 pc(s).	Box

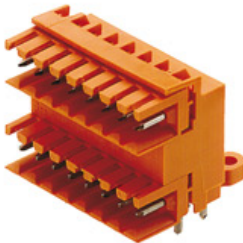
SLD 3.5/90

Two-tier male connector for wave soldering, with 3.50 mm pitch The male connector is available in open, closed and flange versions. The male connectors provide space for labelling and can be coded. Packed in cardboard box.

- 250 V (IEC) / 300 V (UL)
- 10.5 A (IEC) / 8 A (UL)

General ordering data

Order No.	Type	Version	Product data	GTIN (EAN)	Qty.	Packaging
1633390000	SLD 3.50/12/90 3.2SN OR BX	PCB plug-in connector, male header, open side, Solder connection, 3.50 mm, No. of poles: 12, 90°, Solder pin length (l): 3.2 mm, tinned, Orange, Box	IEC: 200 V / 10.5 A UL: 300 V / 8 A	4008190257842	50 pc(s).	Box

BL/SL 3.50 series
BL 3.50/06/270 SN BK BX

Weidmüller Interface GmbH & Co. KG
 Klingenbergstraße 16
 D-32758 Detmold
 Germany
 Fon: +49 5231 14-0
 Fax: +49 5231 14-2083
 www.weidmueller.com

Mating connector (fully pluggable)

SLD 3.5V/90G

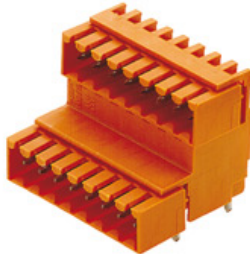

Two-tier offset male connector for wave soldering, with 3.50 mm pitch. The male connector is available in closed and flange versions. The male connectors provide space for labelling and can be coded.

- 250 V (IEC) / 300 V (UL)
- 10.5 A (IEC) / 8 A (UL)

General ordering data

Order No.	Type	Version	Product data	GTIN (EAN)	Qty.	Packaging
1642260000	SLD 3.50 V/12/90G 3.2 SN OR BX	PCB plug-in connector, male header, closed side, Solder connection, 3.50 mm, No. of poles: 12, 90°, Solder pin length (l): 3.2 mm, tinned, Orange, Box	IEC: 200 V / 10.5 A UL: 300 V / 8 A	4008190280789	50 pc(s).	Box

SL 3.5/90

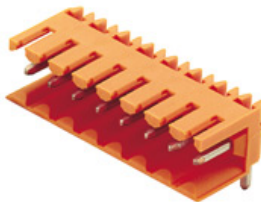

Male connector with 3.50 mm pitch for wave soldering. The male connector is available in open, closed and flange versions. The male connectors provide space for labelling and can be coded. Packed in cardboard box.

- 250 V (IEC) / 300 V (UL)
- 17 A (IEC) / 10 A (UL)

General ordering data

Order No.	Type	Version	Product data	GTIN (EAN)	Qty.	Packaging
1597250000	SL 3.50/06/90 3.2SN OR BX	PCB plug-in connector, male header, open side, Solder connection, 3.50 mm, No. of poles: 6, 90°, Solder pin length (l): 3.2 mm, tinned, Orange, Box	IEC: 320 V / 17 A UL: 300 V / 10 A	4008190163624	50 pc(s).	Box

BL/SL 3.50 series
BL 3.50/06/270 SN BK BX

Weidmüller Interface GmbH & Co. KG
 Klingenbergstraße 16
 D-32758 Detmold
 Germany
 Fon: +49 5231 14-0
 Fax: +49 5231 14-2083
 www.weidmueller.com

Mating connector (fully pluggable)

SL-SMT 3.5/90G Tape



High-temperature-resistant male connector with 3.50 mm pitch for all customary soldering methods. Optimised for automatic assembly. Packed in box or tape. 3.2 mm solder pin suitable for reflow and wave soldering. These male connectors have space for labelling and can be coded.

- 250 V (IEC) / 300 V (UL)
- 15 A (IEC) / 10 A (UL)

General ordering data

Order No.	Type	Version	Product data	GTIN (EAN)	Qty.	Packaging
1761584001	SL-SMT 3.50/06/90G 1.5SN BK RL	PCB plug-in connector, male header, closed side, Reflow solder connection, 3.50 mm, No. of poles: 6, 90°, Solder pin length (l): 1.5 mm, tinned, Black, Tape	IEC: 320 V / 15 A UL: 300 V / 10 A	4032248136025	385 pc(s).	Tape

SL 3.5/180G

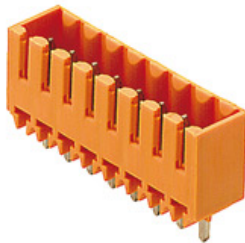

Male connector with 3.50 mm pitch for wave soldering The male connector is available in open, closed and flange versions. The male connectors provide space for labelling and can be coded. Packed in cardboard box.

- 250 V (IEC) / 300 V (UL)
- 17 A (IEC) / 10 A (UL)

General ordering data

Order No.	Type	Version	Product data	GTIN (EAN)	Qty.	Packaging
1604510000	SL 3.50/06/180G 3.2SN OR BX	PCB plug-in connector, male header, closed side, Solder connection, 3.50 mm, No. of poles: 6, 180°, Solder pin length (l): 3.2 mm, tinned, Orange, Box	IEC: 320 V / 17 A UL: 300 V / 10 A	4008190159559	50 pc(s).	Box

**BL/SL 3.50 series
BL 3.50/06/270 SN BK BX**

Weidmüller Interface GmbH & Co. KG
 Klingenbergstraße 16
 D-32758 Detmold
 Germany
 Fon: +49 5231 14-0
 Fax: +49 5231 14-2083
 www.weidmueller.com

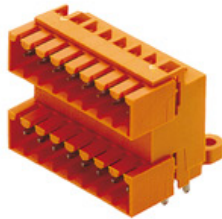
Mating connector (fully pluggable)
SLD 3.5/90G

Two-tier male connector for wave soldering, with 3.50 mm pitch. The male connector is available in open, closed and flange versions. The male connectors provide space for labelling and can be coded. Packed in cardboard box.

- 250 V (IEC) / 300 V (UL)
- 10.5 A (IEC) / 8 A (UL)

General ordering data

Order No.	Type	Version	Product data	GTIN (EAN)	Qty.	Packaging
1633620000	SLD 3.50/12/90G 3.2SN OR BX	PCB plug-in connector, male header, closed side, Solder connection, 3.50 mm, No. of poles: 12, 90°, Solder pin length (l): 3.2 mm, tinned, Orange, Box	IEC: 200 V / 10.5 A UL: 300 V / 8 A	4008190258078	50 pc(s).	Box

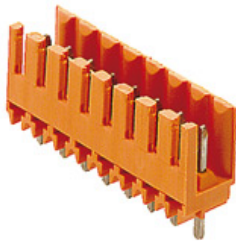
SL 3.5/180

Male connector with 3.50 mm pitch for wave soldering. The male connector is available in open, closed and flange versions. The male connectors provide space for labelling and can be coded. Packed in cardboard box.

- 250 V (IEC) / 300 V (UL)
- 17 A (IEC) / 10 A (UL)

General ordering data

Order No.	Type	Version	Product data	GTIN (EAN)	Qty.	Packaging
1604810000	SL 3.50/06/180 3.2SN OR BX	PCB plug-in connector, male header, open side, Solder connection, 3.50 mm, No. of poles: 6, 180°, Solder pin length (l): 3.2 mm, tinned, Orange, Box	IEC: 320 V / 17 A UL: 300 V / 10 A	4008190145460	50 pc(s).	Box

**BL/SL 3.50 series
BL 3.50/06/270 SN BK BX**

Weidmüller Interface GmbH & Co. KG
 Klingenbergstraße 16
 D-32758 Detmold
 Germany
 Fon: +49 5231 14-0
 Fax: +49 5231 14-2083
 www.weidmueller.com

Mating connector (fully pluggable)
SL-SMT 3.5/90G Box

High-temperature-resistant male connector with 3.50 mm pitch for all customary soldering methods. Optimised for automatic assembly. Packed in box or tape. 3.2 mm solder pin suitable for reflow and wave soldering. These male connectors have space for labelling and can be coded.

- 250 V (IEC) / 300 V (UL)
- 15 A (IEC) / 10 A (UL)

General ordering data

Order No.	Type	Version	Product data	GTIN (EAN)	Qty.	Packaging
1761582001	SL-SMT 3.50/06/90G 1.5SN BK BX	PCB plug-in connector, male header, closed side, Reflow solder connection, 3.50 mm, No. of poles: 6, 90°, Solder pin length (l): 1.5 mm, tinned, Black, Box	IEC: 320 V / 15 A UL: 300 V / 10 A	4032248132072	50 pc(s).	Box
1841670000	SL-SMT 3.50/06/90G 3.2SN BK BX	PCB plug-in connector, male header, closed side, Reflow solder connection, 3.50 mm, No. of poles: 6, 90°, Solder pin length (l): 3.2 mm, tinned, Black, Box	IEC: 320 V / 15 A UL: 300 V / 10 A	4032248353026	50 pc(s).	Box

SL-THR 3.5/135F

High-temperature-resistant male connector with 3.50 mm pitch for all customary soldering methods. Optimised for automatic assembly. Packed in box or tape. 3.2 mm solder pin suitable for reflow and wave soldering. These male connectors have space for labelling and can be coded.

- 250 V (IEC) / 300 V (UL)
- 15 A (IEC) / 10 A (UL)

General ordering data

Order No.	Type	Version	Product data	GTIN (EAN)	Qty.	Packaging
1003550000	SL-SMT 3.50/06/135F 3.2SN BK BX	PCB plug-in connector, male header, Flange, Reflow solder connection, 3.50 mm, No. of poles: 6, 135°, Solder pin length (l): 3.2 mm, tinned, Box	IEC: 320 V / 15 A UL: 300 V / 10 A	4032248726721	50 pc(s).	Box

**BL/SL 3.50 series
BL 3.50/06/270 SN BK BX**

Weidmüller Interface GmbH & Co. KG
Klingenbergstraße 16
D-32758 Detmold
Germany
Fon: +49 5231 14-0
Fax: +49 5231 14-2083
www.weidmueller.com

Mating connector (fully pluggable)
SL-SMT 3.5/180G Tape

High-temperature-resistant male connector with 3.50 mm pitch for all customary soldering methods. Optimised for automatic assembly. Packed in box or tape. 3.2 mm solder pin suitable for reflow and wave soldering. These male connectors have space for labelling and can be coded.

- 250 V (IEC) / 300 V (UL)
- 15 A (IEC) / 10 A (UL)

General ordering data

Order No.	Type	Version	Product data	GTIN (EAN)	Qty.	Packaging
1753024001	SL-SMT 3.50/06/180G 1.5SN BK RL	PCB plug-in connector, male header, closed side, Reflow solder connection, 3.50 mm, No. of poles: 6, 180°, Solder pin length (l): 1.5 mm, tinned, Black, Tape	IEC: 320 V / 15 A UL: 300 V / 10 A	4032248135622	265 pc(s).	Tape

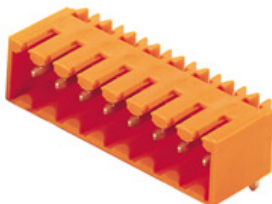
SL 3.5/90G

Male connector with 3.50 mm pitch for wave soldering The male connector is available in open, closed and flange versions. The male connectors provide space for labelling and can be coded. Packed in cardboard box.

- 250 V (IEC) / 300 V (UL)
- 17 A (IEC) / 10 A (UL)

General ordering data

Order No.	Type	Version	Product data	GTIN (EAN)	Qty.	Packaging
1605110000	SL 3.50/06/90G 3.2SN OR BX	PCB plug-in connector, male header, closed side, Solder connection, 3.50 mm, No. of poles: 6, 90°, Solder pin length (l): 3.2 mm, tinned, Orange, Box	IEC: 320 V / 17 A UL: 300 V / 10 A	4008190059552	50 pc(s).	Box

**BL/SL 3.50 series
BL 3.50/06/270 SN BK BX**

Weidmüller Interface GmbH & Co. KG
Klingenbergstraße 16
D-32758 Detmold
Germany
Fon: +49 5231 14-0
Fax: +49 5231 14-2083
www.weidmueller.com

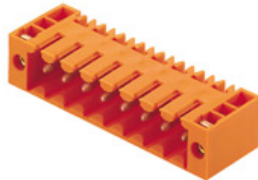
Mating connector (conditionally pluggable)
SL 3.5/90F

Male connector with 3.50 mm pitch for wave soldering The male connector is available in open, closed and flange versions. The male connectors provide space for labelling and can be coded. Packed in cardboard box.

- 250 V (IEC) / 300 V (UL)
- 17 A (IEC) / 10 A (UL)

General ordering data

Order No.	Type	Version	Product data	GTIN (EAN)	Qty.	Packaging
1607080000	SL 3.50/06/90F 3.2SN OR BX	PCB plug-in connector, male header, Flange, Solder connection, 3.50 mm, No. of poles: 6, 90°, Solder pin length (l): 3.2 mm, tinned, Orange, Box	IEC: 320 V / 17 A UL: 300 V / 10 A	4008190101312	50 pc(s).	Box

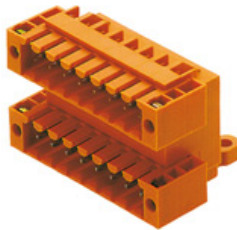
SLD 3.5/90F

Two-tier male connector for wave soldering, with 3.50 mm pitch The male connector is available in open, closed and flange versions. The male connectors provide space for labelling and can be coded. Packed in cardboard box.

- 250 V (IEC) / 300 V (UL)
- 10.5 A (IEC) / 8 A (UL)

General ordering data

Order No.	Type	Version	Product data	GTIN (EAN)	Qty.	Packaging
1633850000	SLD 3.50/12/90F 3.2SN OR BX	PCB plug-in connector, male header, Flange, Solder connection, 3.50 mm, No. of poles: 12, 90°, Solder pin length (l): 3.2 mm, tinned, Orange, Box	IEC: 200 V / 10.5 A UL: 300 V / 8 A	4008190258306	50 pc(s).	Box

**BL/SL 3.50 series
BL 3.50/06/270 SN BK BX**

Weidmüller Interface GmbH & Co. KG
 Klingenbergstraße 16
 D-32758 Detmold
 Germany
 Fon: +49 5231 14-0
 Fax: +49 5231 14-2083
 www.weidmueller.com

Mating connector (conditionally pluggable)
SL-SMT 3.5/180F Box

High-temperature-resistant male connector with 3.50 mm pitch for all customary soldering methods. Optimised for automatic assembly. Packed in box or tape. 3.2 mm solder pin suitable for reflow and wave soldering. These male connectors have space for labelling and can be coded.

- 250 V (IEC) / 300 V (UL)
- 15 A (IEC) / 10 A (UL)

General ordering data

Order No.	Type	Version	Product data	GTIN (EAN)	Qty.	Packaging
1842810000	SL-SMT 3.50/06/180F 3.2SN BK BX	PCB plug-in connector, male header, Flange, Reflow solder connection, 3.50 mm, No. of poles: 6, 180°, Solder pin length (l): 3.2 mm, tinned, Box	IEC: 320 V / 15 A UL: 300 V / 10 A	4032248354177	50 pc(s).	Box
1761002001	SL-SMT 3.50/06/180F 1.5SN BK BX	PCB plug-in connector, male header, Flange, Reflow solder connection, 3.50 mm, No. of poles: 6, 180°, Solder pin length (l): 1.5 mm, tinned, Box	IEC: 320 V / 15 A UL: 300 V / 10 A	4032248131570	50 pc(s).	Box

SL-SMT 3.5/90F Box

High-temperature-resistant male connector with 3.50 mm pitch for all customary soldering methods. Optimised for automatic assembly. Packed in box or tape. 3.2 mm solder pin suitable for reflow and wave soldering. These male connectors have space for labelling and can be coded.

- 250 V (IEC) / 300 V (UL)
- 15 A (IEC) / 10 A (UL)

General ordering data

Order No.	Type	Version	Product data	GTIN (EAN)	Qty.	Packaging
1842120000	SL-SMT 3.50/06/90F 3.2SN BK BX	PCB plug-in connector, male header, Flange, Reflow solder connection, 3.50 mm, No. of poles: 6, 90°, Solder pin length (l): 3.2 mm, tinned, Box	IEC: 320 V / 15 A UL: 300 V / 10 A	4032248353477	50 pc(s).	Box

**BL/SL 3.50 series
BL 3.50/06/270 SN BK BX**

Weidmüller Interface GmbH & Co. KG
 Klingenbergstraße 16
 D-32758 Detmold
 Germany
 Fon: +49 5231 14-0
 Fax: +49 5231 14-2083
 www.weidmueller.com

Mating connector (conditionally pluggable)
SL-SMT 3.5/180LF Tape

High-temperature-resistant male connector with 3.50 mm pitch for all customary soldering methods. Optimised for automatic assembly. Packed in box or tape. 3.2 mm solder pin suitable for reflow and wave soldering. These male connectors have space for labelling and can be coded.

- 250 V (IEC) / 300 V (UL)
- 15 A (IEC) / 10 A (UL)

General ordering data

Order No.	Type	Version	Product data	GTIN (EAN)	Qty.	Packaging
1805270000	SL-SMT 3.50/06/180LF 1.5SN BK RL	PCB plug-in connector, male header, Solder flange, Reflow solder connection, 3.50 mm, No. of poles: 6, 180°, Solder pin length (l): 1.5 mm, tinned, Black, Tape	IEC: 320 V / 15 A UL: 300 V / 10 A	4032248269532	265 pc(s).	Tape

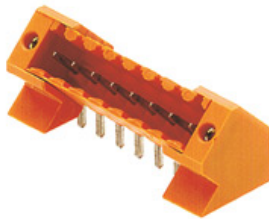
SL 3.5/135F

Male connector with 3.50 mm pitch for wave soldering The male connector is available in open, closed and flange versions. The male connectors provide space for labelling and can be coded. Packed in cardboard box.

- 250 V (IEC) / 300 V (UL)
- 17 A (IEC) / 10 A (UL)

General ordering data

Order No.	Type	Version	Product data	GTIN (EAN)	Qty.	Packaging
1643370000	SL 3.50/06/135F 3.2SN OR BX	PCB plug-in connector, male header, Flange, Solder connection, 3.50 mm, No. of poles: 6, 135°, Solder pin length (l): 3.2 mm, tinned, Orange, Box	IEC: 320 V / 15 A UL: 300 V / 10 A	4008190282134	50 pc(s).	Box

**BL/SL 3.50 series
BL 3.50/06/270 SN BK BX**

Weidmüller Interface GmbH & Co. KG
Klingenbergstraße 16
D-32758 Detmold
Germany
Fon: +49 5231 14-0
Fax: +49 5231 14-2083
www.weidmueller.com

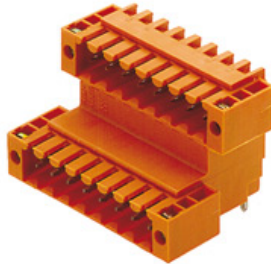
Mating connector (conditionally pluggable)
SLD 3.5V/90F

Two-tier offset male connector for wave soldering, with 3.50 mm pitch. The male connector is available in closed and flange versions. The male connectors provide space for labelling and can be coded.

- 250 V (IEC) / 300 V (UL)
- 10.5 A (IEC) / 8 A (UL)

General ordering data

Order No.	Type	Version	Product data	GTIN (EAN)	Qty.	Packaging
1642390000	SLD 3.50 V/12/90F 3.2 SN OR BX	PCB plug-in connector, male header, Flange, Solder connection, 3.50 mm, No. of poles: 12, 90°, Solder pin length (l): 3.2 mm, tinned, Orange, Box	IEC: 200 V / 10.5 A UL: 300 V / 8 A	4008190280918	50 pc(s).	Box

SL-SMT 3.5/90LF Box

High-temperature-resistant male connector with 3.50 mm pitch for all customary soldering methods. Optimised for automatic assembly. Packed in box or tape. 3.2 mm solder pin suitable for reflow and wave soldering. These male connectors have space for labelling and can be coded.

- 250 V (IEC) / 300 V (UL)
- 15 A (IEC) / 10 A (UL)

General ordering data

Order No.	Type	Version	Product data	GTIN (EAN)	Qty.	Packaging
1804980000	SL-SMT 3.50/06/90LF 1.5SN BK BX	PCB plug-in connector, male header, Solder flange, Reflow solder connection, 3.50 mm, No. of poles: 6, 90°, Solder pin length (l): 1.5 mm, tinned, Box	IEC: 320 V / 15 A UL: 300 V / 10 A	4032248268887	50 pc(s).	Box
1841900000	SL-SMT 3.50/06/90LF 3.2SN BK BX	PCB plug-in connector, male header, Solder flange, Reflow solder connection, 3.50 mm, No. of poles: 6, 90°, Solder pin length (l): 3.2 mm, tinned, Box	IEC: 320 V / 15 A UL: 300 V / 10 A	4032248353255	50 pc(s).	Box

**BL/SL 3.50 series
BL 3.50/06/270 SN BK BX**

Weidmüller Interface GmbH & Co. KG
Klingenbergstraße 16
D-32758 Detmold
Germany
Fon: +49 5231 14-0
Fax: +49 5231 14-2083
www.weidmueller.com

Mating connector (conditionally pluggable)
SL-SMT 3.5/180G Box

High-temperature-resistant male connector with 3.50 mm pitch for all customary soldering methods. Optimised for automatic assembly. Packed in box or tape. 3.2 mm solder pin suitable for reflow and wave soldering. These male connectors have space for labelling and can be coded.

- 250 V (IEC) / 300 V (UL)
- 15 A (IEC) / 10 A (UL)

General ordering data

Order No.	Type	Version	Product data	GTIN (EAN)	Qty.	Packaging
1753022001	SL-SMT 3.50/06/180G 1.5SN BK BX	PCB plug-in connector, male header, closed side, Reflow solder connection, 3.50 mm, No. of poles: 6, 180°, Solder pin length (l): 1.5 mm, tinned, Black, Box	IEC: 320 V / 15 A UL: 300 V / 10 A	4032248130924	50 pc(s).	Box
1842360000	SL-SMT 3.50/06/180G 3.2SN BK BX	PCB plug-in connector, male header, closed side, Reflow solder connection, 3.50 mm, No. of poles: 6, 180°, Solder pin length (l): 3.2 mm, tinned, Black, Box	IEC: 320 V / 15 A UL: 300 V / 10 A	4032248353712	50 pc(s).	Box

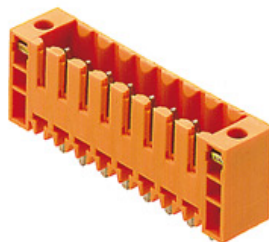
SL 3.5/180F

Male connector with 3.50 mm pitch for wave soldering The male connector is available in open, closed and flange versions. The male connectors provide space for labelling and can be coded. Packed in cardboard box.

- 250 V (IEC) / 300 V (UL)
- 17 A (IEC) / 10 A (UL)

General ordering data

Order No.	Type	Version	Product data	GTIN (EAN)	Qty.	Packaging
1607540000	SL 3.50/06/180F 3.2SN OR BX	PCB plug-in connector, male header, Flange, Solder connection, 3.50 mm, No. of poles: 6, 180°, Solder pin length (l): 3.2 mm, tinned, Orange, Box	IEC: 320 V / 17 A UL: 300 V / 10 A	4008190177140	50 pc(s).	Box

**BL/SL 3.50 series
BL 3.50/06/270 SN BK BX**

Weidmüller Interface GmbH & Co. KG
 Klingenbergstraße 16
 D-32758 Detmold
 Germany
 Fon: +49 5231 14-0
 Fax: +49 5231 14-2083
 www.weidmueller.com

Mating connector (conditionally pluggable)
SL-SMT 3.5/90LF Tape

High-temperature-resistant male connector with 3.50 mm pitch for all customary soldering methods. Optimised for automatic assembly. Packed in box or tape. 3.2 mm solder pin suitable for reflow and wave soldering. These male connectors have space for labelling and can be coded.

- 250 V (IEC) / 300 V (UL)
- 15 A (IEC) / 10 A (UL)

General ordering data

Order No.	Type	Version	Product data	GTIN (EAN)	Qty.	Packaging
1805350000	SL-SMT 3.50/06/90LF 1.5SN BK RL	PCB plug-in connector, male header, Solder flange, Reflow solder connection, 3.50 mm, No. of poles: 6, 90°, Solder pin length (l): 1.5 mm, tinned, Tape	IEC: 320 V / 15 A UL: 300 V / 10 A	4032248269600	385 pc(s).	Tape

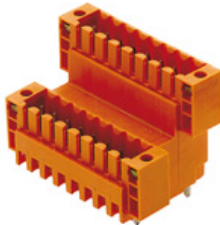
SLD 3.5V/180F

Two-tier offset male connector for wave soldering, with 3.50 mm pitch The male connector is available in closed and flange versions. The male connectors provide space for labelling and can be coded.

- 250 V (IEC) / 300 V (UL)
- 10.5 A (IEC) / 8 A (UL)

General ordering data

Order No.	Type	Version	Product data	GTIN (EAN)	Qty.	Packaging
1641260000	SLD 3.50 V/12/180F 3.2 SN OR BX	PCB plug-in connector, male header, Flange, Solder connection, 3.50 mm, No. of poles: 12, 180°, Solder pin length (l): 3.2 mm, tinned, Orange, Box	IEC: 200 V / 10.5 A UL: 300 V / 8 A	4008190279660	50 pc(s).	Box

**BL/SL 3.50 series
BL 3.50/06/270 SN BK BX**

Weidmüller Interface GmbH & Co. KG
Klingenbergstraße 16
D-32758 Detmold
Germany
Fon: +49 5231 14-0
Fax: +49 5231 14-2083
www.weidmueller.com

Mating connector (conditionally pluggable)

SL-SMT 3.5/180LF Box



High-temperature-resistant male connector with 3.50 mm pitch for all customary soldering methods. Optimised for automatic assembly. Packed in box or tape. 3.2 mm solder pin suitable for reflow and wave soldering. These male connectors have space for labelling and can be coded.

- 250 V (IEC) / 300 V (UL)
- 15 A (IEC) / 10 A (UL)

General ordering data

Order No.	Type	Version	Product data	GTIN (EAN)	Qty.	Packaging
1804740000	SL-SMT 3.50/06/180LF 1.5SN BK BX	PCB plug-in connector, male header, Solder flange, Reflow solder connection, 3.50 mm, No. of poles: 6, 180°, Solder pin length (l): 1.5 mm, tinned, Box	IEC: 320 V / 15 A UL: 300 V / 10 A	4032248268825	50 pc(s).	Box
1842580000	SL-SMT 3.50/06/180LF 3.2SN BK BX	PCB plug-in connector, male header, Solder flange, Reflow solder connection, 3.50 mm, No. of poles: 6, 180°, Solder pin length (l): 3.2 mm, tinned, Box	IEC: 320 V / 15 A UL: 300 V / 10 A	4032248353941	50 pc(s).	Box