

Termination Procedure

LC 1.6mm & 2.0mm Connectors: 1060XX Series

Connector Piece Parts

LC Simplex Connector

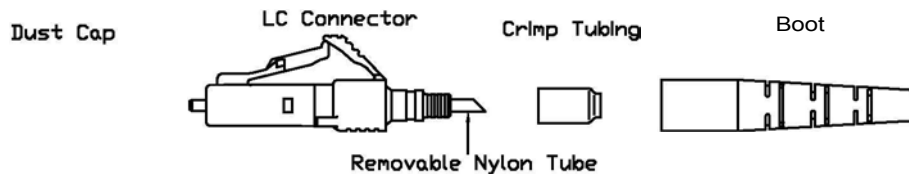

LC Duplex Connector

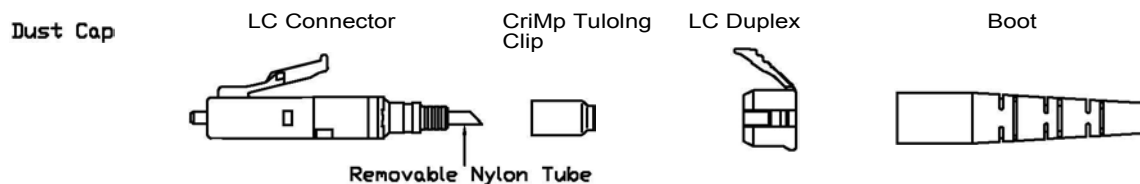

Termination Procedure

LC 1.6mm & 2.0mm Connectors: 1060XX Series



Procedure Chart

Procedure	Tool Required	Tool Part Number
Fiber Preparation & Fiber Cleaning	Cable Preparation Template	86744-1025
	Jacket Stripper-Splitter (1.6mm)	86744-1000
	Jacket Stripper-Splitter (2.0mm)	86744-1100
	Buffer Stripping Tool	86710-0002
	Kevlar and Jacket Cutter	86710-0005
	Crimp Tool	86744-5000
	Duplex Assembly Tool	86744-5000
	*Tissue	86744-0050
	91% Isopropyl Alcohol	86710-0022
		see note
Fiber-To-Ceramic Contact Bonding	*Syringe	86710-0035
	*Needle	86951-0006
	*Epoxy	86710-0024
	Oven, 110 V	86710-4000
	Protective Tubing	86773-0011
	*Tissue	86710-0022
	LC Curing Fixture	86744-1023
	91% Isopropyl Alcohol	see note
Fiber Cleaving	Cleaving Tool	86773-2000
Hand Polishing	LC Polishing Tool	86024-1000
	Blue Rubber Pad	86710-0149
	Polishing Plate	86710-0040
	*Bottle with Polishing Liquid	86710-0160
	*Lapping Film #1 (3x8) Dark Grey w/ Adhesive	86710-0025
	*Lapping Film #9 (3x8) Yellow w/ Adhesive	86710-6158
	*Lapping Film #11 (3x8) Pink No Adhesive	86710-6166
	*Lapping Film (3x4) Purple w/ Adhesive	86930-0011
*Foam Sheet	86710-6167	
Final Inspection	100X Microscope	86730-0030
Machine Polishing	Use your internal procedure	Not available from Molex

*Included in consumable kit p/n 86719-7000.

NOTE: Alcohol must be supplied locally, it is not included with consumable kit. 91% Isopropyl alcohol required.

PLEASE READ THROUGH THE ENTIRE PROCEDURE BEFORE STARTING TO ASSEMBLE A CONNECTOR.

Termination Procedure

LC 1.6mm & 2.0mm Connectors: 1060XX Series

Figure 1

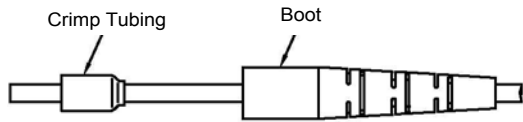

1. Slide the boot and crimp tubing onto the cable (Figure 1).

2. Using the cable preparation template (p/n 86744-1025), precisely strip-split the cable jacket with appropriate jacket stripper-splitter tool (p/n 867744-1000 for 1.6 mm cable or p/n 86744-1100 for 2.0 mm cable) to the correct length. Trim the kevlar using the kevlar cutter (p/n 86710-0005). Using the buffer stripping tool (p/n 86710-0002), precisely strip the buffered fiber. Ensure the tool is free of any debris during this operation. A clogged tool may result in fiber breakage. See the owners manual for the proper operation of this tool. The proper lengths are indicated in the template (Figure 2).

Figure 2

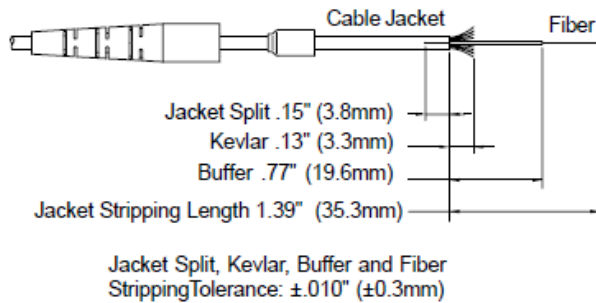

NOTE:

- While holding firmly onto the buffer, it is recommended you strip small lengths (approximately 1/18 inch) of buffer at a time.

- Verify strip lengths with the template. Snip off any excess fiber with the kevlar cutter (p/n 86710-0005).

- The cable manufacturer recommends cleaning the fiber and buffer using a lint-free tissue (p/n 86710-0022) that has been moistened with 91% isopropyl alcohol. Cleanliness of the fiber is essential to the performance and reliability of the connector.

Figure 3

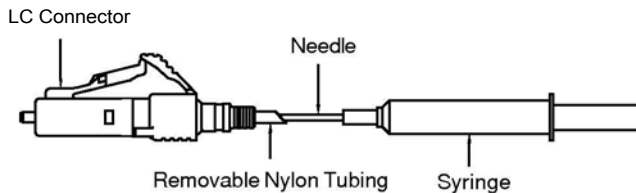

3. Prepare epoxy (p/n 86710-0024) according to the manufacturer's instructions. Fill the syringe (p/n 86710-0035) with epoxy and remove any air bubbles. Wipe the needle with a clean lint-free tissue (p/n 86710-0022). **Do not exceed the pot life of the epoxy (2 hours).**

- Remove the dust cap from the connector and check the ferrule hole for any obstructions by holding it up to a light source.

4. Ensure the nylon tube is fully inserted by pressing it down into the connector. Fully insert the needle of the syringe (p/n 86710-0035) into the nylon tube of the connector until it stops. Keeping the needle at this position, slowly inject epoxy until it appears on the end face of the ferrule. Release pressure on the plunger, hold position for 5 seconds, then remove the needle from the connector (Figure 3).

Figure 4

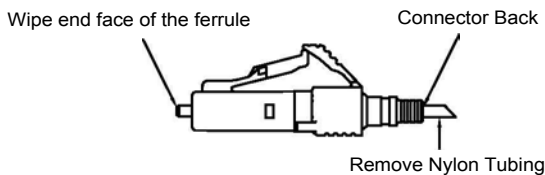

5. With one quick motion, remove the nylon tube from the connector and discard it. With a lint-free tissue (p/n 86710-0022), wipe all the epoxy off the end-face of the ferrule (Figure 4).

IMPORTANT: No epoxy should be present on the side of the ferrule or at the back of the connector.

Termination Procedure

LC 1.6mm & 2.0mm Connectors: 1060XX Series

Figure 5

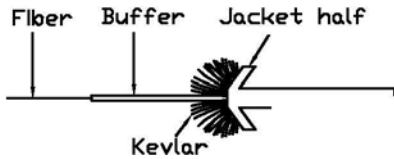

6. Fold the kevlar and jacket halves back towards the cable (Figure 5).

Figure 6

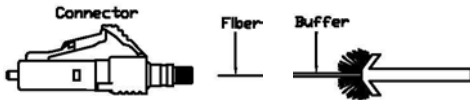

7. Slowly insert the cable into the connector until the fiber is flush with the end-face of the ferrule (Figure 6). It often helps to rotate the connector of the fiber to help find the hole of the ferrule.

- Clean the excess epoxy from the face of the ferrule with a lint-free tissue (p/n 86710-0022) and 91 % isopropyl alcohol.

- The ferrule end-face must be completely free of epoxy.

- Fully slide the protective tubing (p/n 86773-0011) over the ferrule, then fully insert the fiber into the connector (Figure 7).

Figure 7

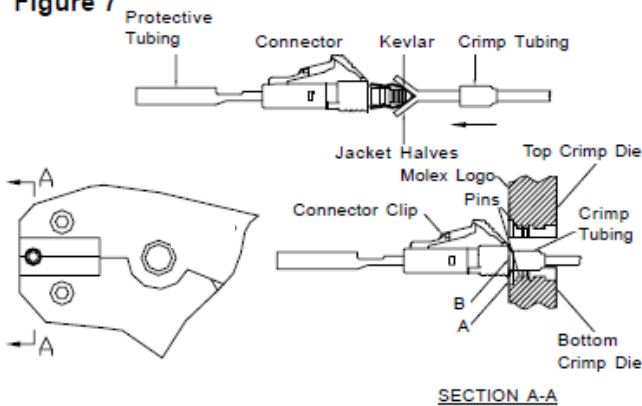

IMPORTANT: To avoid microbending, do not force the fiber into the connector after the buffer has bottomed out.

8. Carefully position the kevlar and jacket halves forward onto the connector end so that the jacket halves are aligned with the connector clip (Figure 7). Slide the crimp tubing over the kevlar and jacket halves up to stop. Place the connector into the bottom die of the crimp tool. Be sure to position the connector so that the pins of the crimp die are aligned with the clip of the connector (Figure 7).

IMPORTANT:

- Ensure rectangle dies are located to the rear of the termini crimp sleeve as shown in figure 7 & 10.

Figure 8

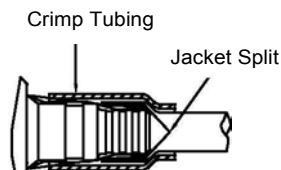

IMPORTANT:

- Surface A of the bottom crimp die must be in contact with surface B of the connector. Proceed to crimp.

- It is extremely important that the crimp tubing covers the jacket split (Figure 8).

Termination Procedure

LC 1.6mm & 2.0mm Connectors: 1060XX Series

Figure 9

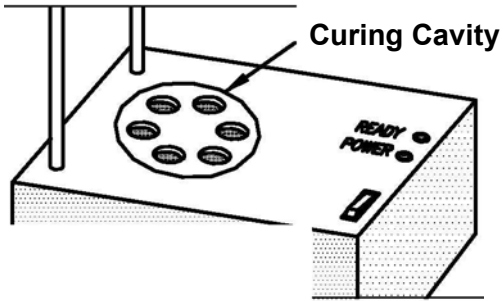

9. Place the connector with protective tubing into one of the curing oven cavities after the oven has reached its operating temperature 140°C. A beep indicates the start of the curing cycle (Figure 9).

IMPORTANT: During the curing cycle, the cable should be maintained vertically to avoid any bending which can cause microbend losses after assembly.

Each cavity of the oven is independently controlled. An LED and a beep will indicate the end of the curing cycle (15 minutes). After the epoxy is cured, remove the connector from the oven and allow it to cool.

Figure 10

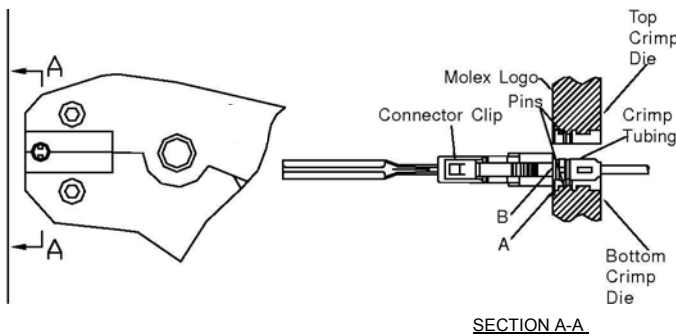

10. Repeat the crimping operation of step 8 so the pins of the crimp die are oriented 90° from the clip of the connector. Precisely hold this position and crimp (Figure 10).

IMPORTANT: For the LC Simplex Connector, proceed to step 11. For the LC Duplex Connector, proceed to step 12.

Figure 11

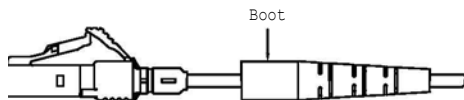

11. For the LC simplex connector, slide the boot onto the connector until it snaps on (Figure 11).

Figure 12

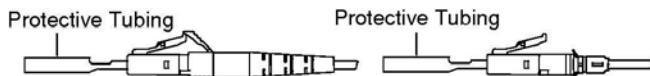

12. For the LC duplex connector, carefully remove the protective tubing from the connector (Figure 12).

Termination Procedure

LC 1.6mm & 2.0mm Connectors: 1060XX Series

Figure 13

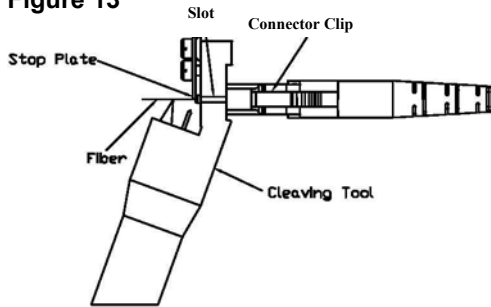

13. Holding the cleaving tool (p/n 86773-2000), with the trigger upwards, slowly insert the protruding fiber into the slot of the cleaving tool, then push the connector until the ferrule comes in contact with the stop plate (Figure 13).

IMPORTANT: The connector clip should be aligned with the slot of the cleaving tool.

14. When cleaving, position the connector and cleaving tool (p/n 86773-2000) over the debris container. Release the connector and gently press the trigger to cleave the fiber. Remove the connector from the tool. Be sure to dispose of the cleaved fiber properly.

Figure 14

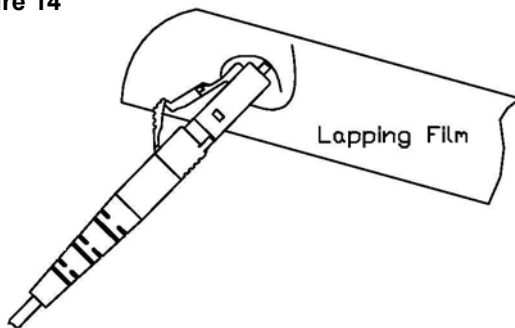

Hand Polishing:

15. Begin to hand polish the face of the connector with lapping film #1 (p/n 86710-0025) (Figure 14). The circular motions should be approximately two inches in diameter. The lapping film is held by hand and virtually no pressure is applied on the protruding glass fiber. Perform five-to-ten circular motions on the contact.

16. Carefully and gently clean the ferrule with a lint-free tissue (p/n 86710-0022) and 91% isopropyl alcohol.

17. Carefully mount the connector into the polishing tool (p/n 86024-1000).

Figure 15

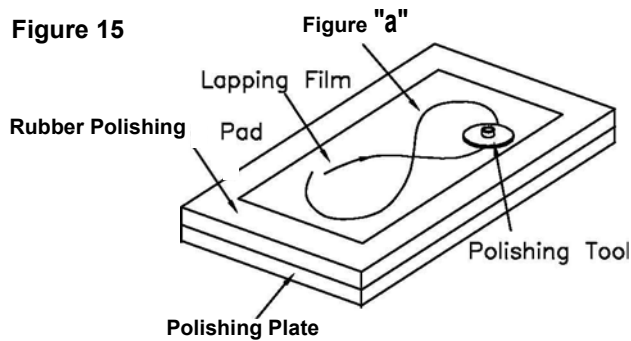

NOTE:

Before using lapping film in steps #1 and #4, remove paper backing to expose adhesive and press the lapping film on the rubber polishing pad (p/n 86710-0149). Use polishing plate (p/n 86710-0040) as base for rubber polishing pad (Figure 15).

Termination Procedure

LC 1.6mm & 2.0mm Connectors: 860XX Series

Step	Lapping Film	Polishing Fluid	Number of Figure "8" Motions
1	p/n 86710-6158	91 % Isopropyl Alcohol	15-20
2	p/n 86710-6166	91 % Isopropyl Alcohol	15
3	p/n 86930-0011	Polishing Liquid (86710-0160)	10
4	(Foam Sheet) p/n 86710-6167	Polishing Liquid (86710-0160)	2-3

STEP #1: Using the rubber polishing pad (p/n 86710-0149), mount a sheet of #9 lapping film (p/n 86710-6158). Liberally apply a layer of 91 % isopropyl alcohol on the surface of the lapping film and perform figure "8" motions over the entire length of the lapping film according to the table (Figure 16). Virtually no pressure should be applied on the tool at the beginning of the procedure. If epoxy is still visible after this step, perform two-to-three additional figure "8" motions.

NOTE:

Gently clean the contact with a lint-free tissue (p/n 86710-0022) and 91% isopropyl alcohol between each polishing step. For best results, replace the film every four terminations.

STEP #2: Using the rubber polishing pad (p/n 86710-0149), mount a sheet of #11 lapping film (p/n 86710-6166). Liberally apply a layer of 91 % isopropyl alcohol on the surface of the lapping film and perform figure "8" motions over the entire length of the film according to the table (Figure 16).

STEP #3: Using the rubber polishing pad (p/n 86710-0149), mount a sheet of lapping film (1 mm diamond p/n 86930-0011). Use the bottle with polishing liquid (p/n 86710-0160) and liberally apply a layer of polishing liquid on the surface of the lapping film. Perform figure "8" motions over the entire length of the film according to the table (Figure 16). Be sure to avoid and remove any air pockets under the film before polishing.

STEP #4: Using the rubber pad (p/n 86710-0149), mount a foam sheet (p/n 86710-6167). Use the bottle with polishing liquid (p/n 86710-0160) and liberally apply a layer of polishing liquid on the surface of foam sheet. Perform figure "8" motions over the entire length of the polishing pad.

Figure 17

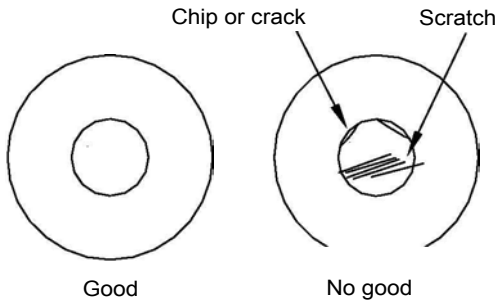

18. Remove the connector from the polishing tool. Thoroughly clean the ferrule with a lint-free tissue (p/n 86710-0022) and 91% isopropyl alcohol. Using the 100X microscope (p/n 86730-0030), inspect the quality of the polish. No scratches or cracks should be visible (Figure 17).

NOTE:

The microscope should be stored in the closed position when not in use. This will ensure longer battery life.

Figure 18

Endface Geometry	Requirements
Fiber extension	-0.05 urn < x < 0.05~m
Ferrule endface radius	7mm "R" 25mm
Apex offset	Less than 50~m

19. Check the ferrule endface geometry using Zoom Interferometer ZX-1 (from Direct Optical Research Company). Use figure 18 to determine if the ferrule endface geometry is within required specifications. If it is not, return the cable to the line for re-work.

20. If tuning is required, refer to the tuning procedure (p/n 86001-0109).

NOTE:

If tuning is not required:

- For the LC Simplex Connector proceed to step 21.
- For the LC Duplex Connector, proceed to step 22.

Figure 19

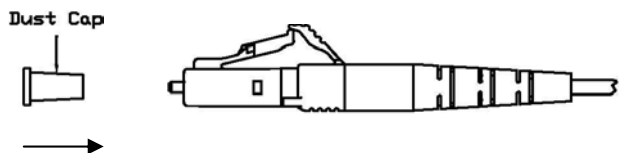

21. Carefully and thoroughly clean the optical contact with a lint free tissue (p/n 86710-0022) and 91 % isopropyl alcohol. Cover the connector with the dust cap (Figure 19).

Termination Procedure

LC 1.6mm & 2.0mm Connectors: 860XX Series

Figure 20

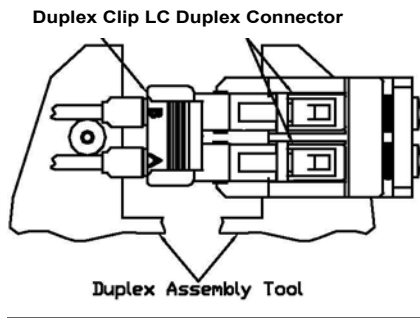

22. Pre-assemble the LC Duplex clip with the connectors (Figure 20), and position this subassembly into the Duplex Assembly Tool (p/n 86744-0050). Carefully squeeze the handles of the Duplex Assembly Tool until the Duplex clip snaps in. Remove the duplex connector from the assembly tool.

Figure 21

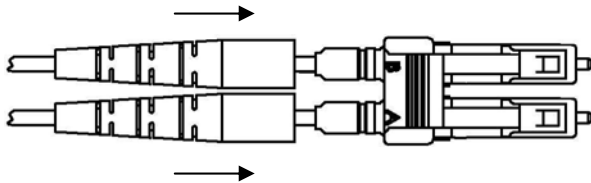

23. Slide the boots over the crimp tubing until they snap in (Figure 21).

Figure 22

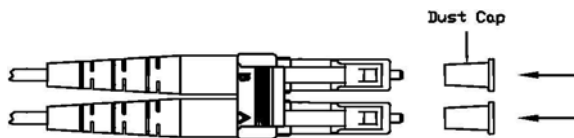

24. Carefully and thoroughly clean the ferrules with a lint-free tissue (p/n 86710-0022) and 91% isopropyl alcohol. Cover the connectors with the dust caps (Figure 22).

Rev	Description	Revised By	Date	Approvals
A	Initial Release	G. Genchanok	11/1/1999	GG
B	Added note regarding rectangle die orientation after step 8	G. Genchanok	5/10/2010	GG