

**OMNIMATE Signal - series BL/SL 3.50  
BL 3.50/12/270 SN OR BX**

**Weidmüller Interface GmbH & Co. KG**  
 Klingenbergstraße 16  
 D-32758 Detmold  
 Germany  
 Fon: +49 5231 14-0  
 Fax: +49 5231 14-292083  
 www.weidmueller.com

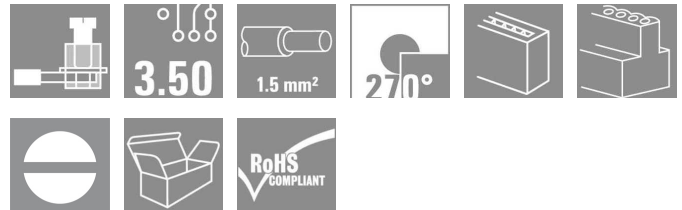

Female connectors with clamping yoke screw system for connecting conductors at 3.50 mm pitch. They provide space for labelling and can be coded.

**General ordering data**

Type	BL 3.50/12/270 SN OR BX
Order No.	<a href="#">1639570000</a>
Version	PCB plug-in connector, female plug, 3.50 mm, No. of poles: 12, 270°, Clamping yoke connection, Clamping range, rated connection, max.: 1.5 mm <sup>2</sup> , Box
GTIN (EAN)	4008190277123
Qty.	50 pc(s).
Product data	IEC: 320 V / 12 A / 0.2 - 1.5 mm <sup>2</sup> UL: 300 V / 8 A / AWG 28 - AWG 14
Packaging	Box

**OMNIMATE Signal - series BL/SL 3.50  
BL 3.50/12/270 SN OR BX**

**Weidmüller Interface GmbH & Co. KG**  
Klingenbergstraße 16  
D-32758 Detmold  
Germany  
Fon: +49 5231 14-0  
Fax: +49 5231 14-292083  
www.weidmueller.com

**Technical data****Dimensions and weights**

Net weight	11.96 g
------------	---------

**System parameters**

Product family	OMNIMATE Signal - series BL/SL 3.50	Wire connection method	Clamping yoke connection
Conductor outlet direction	270°	Pitch in mm (P)	3.5 mm
Pitch in inches (P)	0.138 inch	No. of poles	12
Plugging cycles	25	Screwdriver blade	0.4 x 2.5
Screwdriver blade standard	DIN 5264	Tightening torque, min.	0.2 Nm
Tightening torque, max.	0.25 Nm	Clamping screw	M 2
Stripping length	6 mm	L1 in mm	38.5 mm
L1 in inches	1.516 inch	Touch-safe protection acc. to DIN VDE 0470	IP 20
Touch-safe protection acc. to DIN VDE 57 106	Safe from finger touch	Clearance, min.	4.2 mm
Creepage distance, min.	4.2 mm		

**Material data**

Insulating material	PBT	Moisture Level (MSL)	3
Colour	Orange	Colour chart (similar)	RAL 2000
UL 94 flammability rating	V-0	CTI	≥ 200
Contact material	Cu-Leg	Contact surface	tinned
Operating temperature, min.	-50 °C	Operating temperature, max.	100 °C
Temperature range, installation, min.	-30 °C	Temperature range, installation, max.	100 °C

**Connectable conductors**

Clamping range, rated connection, min.	0.08 mm <sup>2</sup>	Clamping range, rated connection, max.	1.5 mm <sup>2</sup>
Wire connection cross section AWG, min.	AWG 28	Wire connection cross section AWG, max.	AWG 14
Solid, min. H05(07) V-U	0.2 mm <sup>2</sup>	Solid, max. H05(07) V-U	1.5 mm <sup>2</sup>
Flexible, min. H05(07) V-K	0.2 mm <sup>2</sup>	Flexible, max. H05(07) V-K	1.5 mm <sup>2</sup>
w. wire end ferrule, DIN 46228 pt 1, min.	0.2 mm <sup>2</sup>	w. wire end ferrule, DIN 46228 pt 1, max.	1.5 mm <sup>2</sup>
w. plastic collar ferrule, DIN 46228 pt 4, min.	0.2 mm <sup>2</sup>	w. plastic collar ferrule, DIN 46228 pt 4, max.	1.5 mm <sup>2</sup>
Plug gauge acc. to EN 60999 a x b; Ø	2.4 mm x 1.5 mm		

**Rating data acc. to IEC 60664-1 / IEC 61984**

Rated current, min. no. of poles (Tu=20°C)	12 A	Rated current, max. no. of poles (Tu=20°C)	10 A
Rated current, number of poles (Tu=40°C), min	10 A	Rated current, number of poles (Tu=40°C), max.	8 A
Rated voltage for surge voltage class / pollution degree II/2	320 V	Rated voltage for surge voltage class / pollution degree III/2	160 V
Rated voltage for surge voltage class / pollution degree III/3	160 V	Rated impulse voltage for surge voltage class/ pollution degree II/2	2.5 kV
Rated impulse voltage for surge voltage class/ pollution degree III/2	2.5 kV	Rated impulse voltage for surge voltage class/ contamination degree III/3	2.5 kV
Short-time withstand current resistance	3 x 1s with 100 A		

**Data sheet**

**OMNIMATE Signal - series BL/SL 3.50  
BL 3.50/12/270 SN OR BX**

**Weidmüller Interface GmbH & Co. KG**  
Klingenbergstraße 16  
D-32758 Detmold  
Germany  
Fon: +49 5231 14-0  
Fax: +49 5231 14-292083  
www.weidmueller.com

**Technical data**

**CSA rating data**

Institute (CSA)		Certificate No. (CSA)	
		154685-1318353	
Rated voltage (Use group B)	300 V	Rated current (use group B)	10 A
Rated voltage (use group D)	300 V	Rated current (use group D)	10 A
Wire cross-section, AWG, min.	AWG 28	Wire cross-section, AWG, max.	AWG 14

**UL 1059 rating data**

Institute (UR)		Certificate No. (UR)	
		E60693	
Rated voltage (use group B)	300 V	Rated current (use group B)	8 A
Rated voltage (use group D)	300 V	Rated current (use group D)	8 A
Wire cross-section, AWG, min.	AWG 28	Wire cross-section, AWG, max.	AWG 14

**Classifications**

ETIM 3.0	EC001284	ETIM 4.0	EC002637
ETIM 5.0	EC002637	ETIM 6.0	EC002637
UNSPSC	30-21-18-10	eClass 5.1	27-26-07-04
eClass 6.2	27-26-07-04	eClass 7.1	27-44-04-02

**Notes**

- Notes
- Additional colours on request
  - Gold-plated contact surfaces on request
  - Rated current related to rated cross-section & min. No. of poles.
  - Max. outer diameter of the conductor: 2.9 mm
  - Wire end ferrule without plastic collar to DIN 46228/1
  - Wire end ferrule with plastic collar to DIN 46228/4
  - P on drawing = pitch
  - Rated data refer only to the component itself. Clearance and creepage distances to other components are to be designed in accordance with the relevant application standards.

IPC conformity      The products are developed, manufactured and delivered according to the internationally recognised IPC-A-610 standard, category "permissible". More extensive demands on the products can be evaluated on request.

**Approvals**



ROHS      Conform

**Data sheet**

**OMNIMATE Signal - series BL/SL 3.50  
BL 3.50/12/270 SN OR BX**

**Weidmüller Interface GmbH & Co. KG**  
 Klingenbergstraße 16  
 D-32758 Detmold  
 Germany  
 Fon: +49 5231 14-0  
 Fax: +49 5231 14-292083  
 www.weidmueller.com

**Drawings**

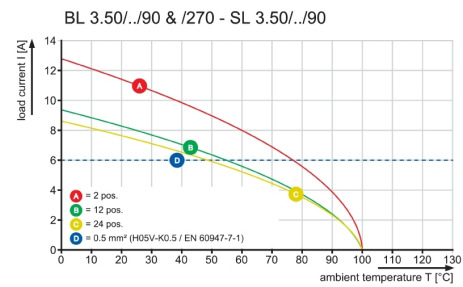
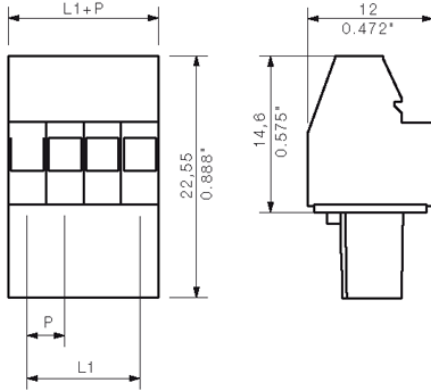

**OMNIMATE Signal - series BL/SL 3.50  
BL 3.50/12/270 SN OR BX**

**Weidmüller Interface GmbH & Co. KG**  
Klingenbergstraße 16  
D-32758 Detmold  
Germany  
Fon: +49 5231 14-0  
Fax: +49 5231 14-292083  
www.weidmueller.com

**Mating connector (conditionally pluggable)**
**SLD 3.50V/90F**

Double-level, staggered pin header for wave soldering at 3.50 mm pitch. They are available in closed and flanged versions. The male connectors provide space for labelling and can be coded.

**General ordering data**

Type	Order No.	Version	GTIN (EAN)	Qty.	Product data	Packaging
SLD 3.50 V/24/90F 3.2 SN OR BX	<a href="#">1642420000</a>	PCB plug-in connector, male header, Flange, Solder connection, 3.50 mm, No. of poles: 24, 90°, Solder pin length (l): 3.2 mm, tinned, Orange, Box	4008190280949	10 pc(s).	IEC: 200 V / 10.5 A UL: 300 V / 8 A	Box

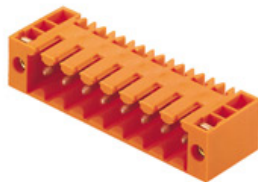
**SL 3.50/90F**

Pin headers for wave soldering in 3.50 mm pitch

- Plugging direction is parallel (90°), straight 180° or angled (135°) to the PCB
- Housing variant: screw flange (F)
- Packed in a cardboard box (BX)
- Pin header can be coded

**General ordering data**

Type	Order No.	Version	GTIN (EAN)	Qty.	Product data	Packaging
SL 3.50/12/90F 3.2SN OR BX	<a href="#">1607140000</a>	PCB plug-in connector, male header, Flange, Solder connection, 3.50 mm, No. of poles: 12, 90°, Solder pin length (l): 3.2 mm, tinned, Orange, Box	4008190092375	50 pc(s).	IEC: 320 V / 17 A UL: 300 V / 10 A	Box

**OMNIMATE Signal - series BL/SL 3.50  
BL 3.50/12/270 SN OR BX**

**Weidmüller Interface GmbH & Co. KG**  
Klingenbergstraße 16  
D-32758 Detmold  
Germany  
Fon: +49 5231 14-0  
Fax: +49 5231 14-292083  
www.weidmueller.com

**Mating connector (conditionally pluggable)**
**SL-SMT 3.5/180G Box**

**High-temperature-resistant male header, 3.50 mm pitch.**

- **Plugging direction parallel (90°), straight 180° or angled (135°) to PCB**
- **Housing variants: closed side (G), screw flange (F), solder flange (LF) or snap-on solder flange (RF)**
- **Optimised for the SMT process**
- **Pin length 3.2 mm universal for all soldering methods**
- **Pin length 1.5 mm optimised for reflow soldering methods**
- **Packed either in a box (BX) or tape-on-reel (RL)**
- **Male header can be coded**

**General ordering data**

Type	Order No.	Version	GTIN (EAN)	Qty.	Product data	Packaging
SL-SMT 3.50/12/180G 1.5SN BK BX	<a href="#">1753082001</a>	PCB plug-in connector, male header, closed side, Reflow solder connection, 3.50 mm, No. of poles: 12, 180°, Solder pin length (l): 1.5 mm, tinned, Black, Box	4032248130986	50 pc(s).	IEC: 320 V / 15 A UL: 300 V / 10 A	Box
SL-SMT 3.50/12/180G 3.2SN BK BX	<a href="#">1842410000</a>	PCB plug-in connector, male header, closed side, Reflow solder connection, 3.50 mm, No. of poles: 12, 180°, Solder pin length (l): 3.2 mm, tinned, Black, Box	4032248353767	50 pc(s).	IEC: 320 V / 15 A UL: 300 V / 10 A	Box

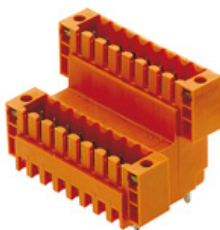
**SLD 3.50V/180F**

Double-level, staggered pin header for wave soldering at 3.50 mm pitch. They are available in closed and flanged versions. The male connectors provide space for labelling and can be coded.

**General ordering data**

Type	Order No.	Version	GTIN (EAN)	Qty.	Product data	Packaging
SLD 3.50 V/24/180F 3.2 SN OR BX	<a href="#">1641290000</a>	PCB plug-in connector, male header, Flange, Solder connection, 3.50 mm, No. of poles: 24, 180°, Solder	4008190279691	10 pc(s).	IEC: 200 V / 10.5 A UL: 300 V / 8 A	Box

**OMNIMATE Signal - series BL/SL 3.50  
BL 3.50/12/270 SN OR BX**

**Weidmüller Interface GmbH & Co. KG**  
Klingenbergstraße 16  
D-32758 Detmold  
Germany  
Fon: +49 5231 14-0  
Fax: +49 5231 14-292083  
www.weidmuller.com

**Mating connector (conditionally pluggable)**

pin length (l): 3.2 mm,  
tinned, Orange, Box

**SL-SMT 3.5/180LF Box**

**High-temperature-resistant male header, 3.50 mm pitch.**

- **Plugging direction parallel (90°), straight 180° or angled (135°) to PCB**
- **Housing variants: closed side (G), screw flange (F), solder flange (LF) or snap-on solder flange (RF)**
- **Optimised for the SMT process**
- **Pin length 3.2 mm universal for all soldering methods**
- **Pin length 1.5 mm optimised for reflow soldering methods**
- **Packed either in a box (BX) or tape-on-reel (RL)**
- **Male header can be coded**

**General ordering data**

Type	Order No.	Version	GTIN (EAN)	Qty.	Product data	Packaging
SL-SMT 3.50/12/180LF 1.5SN BK BX	<a href="#">1804800000</a>	PCB plug-in connector, male header, Solder flange, Reflow solder connection, 3.50 mm, No. of poles: 12, 180°, Solder pin length (l): 1.5 mm, tinned, Black, Box	4032248268580	50 pc(s).	IEC: 320 V / 15 A UL: 300 V / 10 A	Box
SL-SMT 3.50/12/180LF 3.2SN BK BX	<a href="#">1842640000</a>	PCB plug-in connector, male header, Solder flange, Reflow solder connection, 3.50 mm, No. of poles: 12, 180°, Solder pin length (l): 3.2 mm, tinned, Black, Box	4032248354009	50 pc(s).	IEC: 320 V / 15 A UL: 300 V / 10 A	Box

**OMNIMATE Signal - series BL/SL 3.50  
BL 3.50/12/270 SN OR BX**

**Weidmüller Interface GmbH & Co. KG**  
Klingenbergstraße 16  
D-32758 Detmold  
Germany  
Fon: +49 5231 14-0  
Fax: +49 5231 14-292083  
www.weidmueller.com

**Mating connector (conditionally pluggable)**
**SL-SMT 3.5/90F Box**

**High-temperature-resistant male header, 3.50 mm pitch.**

- **Plugging direction parallel (90°), straight 180° or angled (135°) to PCB**
- **Housing variants: closed side (G), screw flange (F), solder flange (LF) or snap-on solder flange (RF)**
- **Optimised for the SMT process**
- **Pin length 3.2 mm universal for all soldering methods**
- **Pin length 1.5 mm optimised for reflow soldering methods**
- **Packed either in a box (BX) or tape-on-reel (RL)**
- **Male header can be coded**

**General ordering data**

Type	Order No.	Version	GTIN (EAN)	Qty.	Product data	Packaging
SL-SMT	<a href="#">1842180000</a>	PCB plug-in connector, male	4032248353538	50 pc(s).	IEC: 320 V / 15 A UL: 300 V / 10 A	Box
3.50/12/90F		header, Flange, Reflow				
3.2SN BK BX		solder connection, 3.50 mm, No. of poles: 12, 90°, Solder pin length (l): 3.2 mm, tinned, Black, Box				

**SL-SMT 3.5/90LF Box**

**High-temperature-resistant male header, 3.50 mm pitch.**

- **Plugging direction parallel (90°), straight 180° or angled (135°) to PCB**
- **Housing variants: closed side (G), screw flange (F), solder flange (LF) or snap-on solder flange (RF)**
- **Optimised for the SMT process**
- **Pin length 3.2 mm universal for all soldering methods**
- **Pin length 1.5 mm optimised for reflow soldering methods**
- **Packed either in a box (BX) or tape-on-reel (RL)**
- **Male header can be coded**

**General ordering data**

Type	Order No.	Version	GTIN (EAN)	Qty.	Product data	Packaging
SL-SMT	<a href="#">1804340000</a>	PCB plug-in connector, male header, Solder flange, Reflow solder connection, 3.50 mm, No. of poles: 12,	4032248288533	50 pc(s).	IEC: 320 V / 15 A UL: 300 V / 10 A	Box
3.50/12/90LF						
3.2SN BK BX						

Creation date February 23, 2015 1:47:20 PM CET

**Data sheet**

**OMNIMATE Signal - series BL/SL 3.50  
BL 3.50/12/270 SN OR BX**

**Weidmüller Interface GmbH & Co. KG**  
Klingenbergstraße 16  
D-32758 Detmold  
Germany  
Fon: +49 5231 14-0  
Fax: +49 5231 14-292083  
www.weidmueller.com

**Mating connector (conditionally pluggable)**

SL-SMT	<a href="#">1805040000</a>	90°, Solder pin length (l): 3.2 mm, tinned, Black, Box	4032248268948 50 pc(s).	IEC: 320 V / 15 A UL: 300 V / 10 A	Box
3.50/12/90LF		PCB plug-in connector, male header, Solder flange, Reflow solder connection, 3.50 mm, No. of poles: 12, 90°, Solder pin length (l): 1.5 mm, tinned, Black, Box			
1.5SN BK BX					

**SL 3.50/135F**

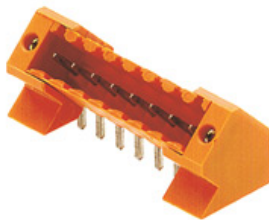

Pin headers for wave soldering in 3.50 mm pitch

- Plugging direction is parallel (90°), straight 180° or angled (135°) to the PCB
- Housing variant: screw flange (F)
- Packed in a cardboard box (BX)
- Pin header can be coded

**General ordering data**

Type	Order No.	Version	GTIN (EAN)	Qty.	Product data	Packaging
SL	<a href="#">1643430000</a>	PCB plug-in connector, male header, Flange, Solder connection, 3.50 mm, No. of poles: 12, 135°, Solder pin length (l): 3.2 mm, tinned, Orange, Box	4008190282196 50 pc(s).		IEC: 320 V / 15 A UL: 300 V / 10 A	Box

**OMNIMATE Signal - series BL/SL 3.50  
BL 3.50/12/270 SN OR BX**

**Weidmüller Interface GmbH & Co. KG**  
Klingenbergstraße 16  
D-32758 Detmold  
Germany  
Fon: +49 5231 14-0  
Fax: +49 5231 14-292083  
www.weidmueller.com

**Mating connector (conditionally pluggable)**
**SL-SMT 3.5/180F Box**

**High-temperature-resistant male header, 3.50 mm pitch.**

- **Plugging direction parallel (90°), straight 180° or angled (135°) to PCB**
- **Housing variants: closed side (G), screw flange (F), solder flange (LF) or snap-on solder flange (RF)**
- **Optimised for the SMT process**
- **Pin length 3.2 mm universal for all soldering methods**
- **Pin length 1.5 mm optimised for reflow soldering methods**
- **Packed either in a box (BX) or tape-on-reel (RL)**
- **Male header can be coded**

**General ordering data**

Type	Order No.	Version	GTIN (EAN)	Qty.	Product data	Packaging
SL-SMT	<a href="#">1842870000</a>	PCB plug-in connector, male	4032248354337	50 pc(s).	IEC: 320 V / 15 A UL: 300 V / 10 A	Box
3.50/12/180F		header, Flange, Reflow				
3.2SN BK BX		solder connection, 3.50 mm, No. of poles: 12, 180°, Solder pin length (l): 3.2 mm, tinned, Black, Box				

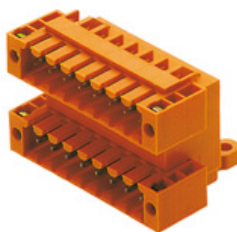
**SLD 3.50/90F**

Two-tier pin header for wave soldering in 3.50 mm pitch. The connector is available in open, closed and flange versions. The male connectors provide space for labelling and can be coded. Packed in a cardboard box.

**General ordering data**

Type	Order No.	Version	GTIN (EAN)	Qty.	Product data	Packaging
SLD	<a href="#">1633910000</a>	PCB plug-in connector, male header, Flange, Solder connection, 3.50 mm, No. of poles: 24, 90°, Solder pin length (l): 3.2 mm, tinned, Orange, Box	4008190258368	10 pc(s).	IEC: 200 V / 10.5 A UL: 300 V / 8 A	Box
3.50/24/90F						
3.2SN OR BX						

**OMNIMATE Signal - series BL/SL 3.50  
BL 3.50/12/270 SN OR BX**

**Weidmüller Interface GmbH & Co. KG**  
Klingenbergstraße 16  
D-32758 Detmold  
Germany  
Fon: +49 5231 14-0  
Fax: +49 5231 14-292083  
www.weidmueller.com

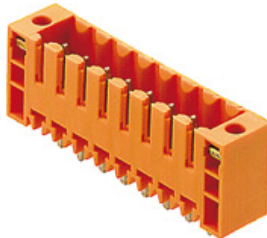
**Mating connector (conditionally pluggable)**
**SL 3.50/180F**

Pin headers for wave soldering in 3.50 mm pitch

- Plugging direction is parallel (90°), straight 180° or angled (135°) to the PCB
- Housing variant: screw flange (F)
- Packed in a cardboard box (BX)
- Pin header can be coded

**General ordering data**

Type	Order No.	Version	GTIN (EAN)	Qty.	Product data	Packaging
SL 3.50/12/180F 3.2SN OR BX	<a href="#">1607600000</a>	PCB plug-in connector, male header, Flange, Solder connection, 3.50 mm, No. of poles: 12, 180°, Solder pin length (l): 3.2 mm, tinned, Orange, Box	4008190164935	50 pc(s).	IEC: 320 V / 17 A UL: 300 V / 10 A	Box

**OMNIMATE Signal - series BL/SL 3.50  
BL 3.50/12/270 SN OR BX**

**Weidmüller Interface GmbH & Co. KG**  
Klingenbergstraße 16  
D-32758 Detmold  
Germany  
Fon: +49 5231 14-0  
Fax: +49 5231 14-292083  
www.weidmueller.com

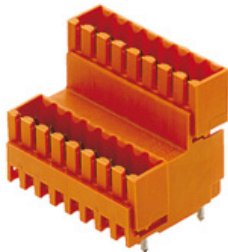
**Mating connector (fully pluggable)**
**SLD 3.50V/180G**

Double-level, staggered pin header for wave soldering at 3.50 mm pitch. They are available in closed and flanged versions. The male connectors provide space for labelling and can be coded.

**General ordering data**

Type	Order No.	Version	GTIN (EAN)	Qty.	Product data	Packaging
SLD	<a href="#">1641160000</a>	PCB plug-in connector, male header, closed side, Solder connection, 3.50 mm, No. of poles: 24, 180°, Solder pin length (l): 3.2 mm, tinned, Orange, Box	4008190279561	10 pc(s).	IEC: 200 V / 10.5 A UL: 300 V / 8 A	Box

**SL-SMT 3.5/90G Box**

**High-temperature-resistant male header, 3.50 mm pitch.**

- **Plugging direction parallel (90°), straight 180° or angled (135°) to PCB**
- **Housing variants: closed side (G), screw flange (F), solder flange (LF) or snap-on solder flange (RF)**
- **Optimised for the SMT process**
- **Pin length 3.2 mm universal for all soldering methods**
- **Pin length 1.5 mm optimised for reflow soldering methods**
- **Packed either in a box (BX) or tape-on-reel (RL)**
- **Male header can be coded**

**General ordering data**

Type	Order No.	Version	GTIN (EAN)	Qty.	Product data	Packaging
SL-SMT	<a href="#">1761642001</a>	PCB plug-in connector, male header, closed side, Reflow solder connection, 3.50 mm, No. of poles: 12, 90°, Solder pin length (l): 1.5 mm, tinned, Black, Box	4032248132232	50 pc(s).	IEC: 320 V / 15 A UL: 300 V / 10 A	Box
SL-SMT	<a href="#">1841730000</a>	PCB plug-in connector, male header, closed side, Reflow solder connection, 3.50 mm, No. of poles: 12, 90°	4032248353088	50 pc(s).	IEC: 320 V / 15 A UL: 300 V / 10 A	Box

## OMNIMATE Signal - series BL/SL 3.50 BL 3.50/12/270 SN OR BX

**Weidmüller Interface GmbH & Co. KG**  
Klingenbergstraße 16  
D-32758 Detmold  
Germany  
Fon: +49 5231 14-0  
Fax: +49 5231 14-292083  
www.weidmueller.com

### Mating connector (fully pluggable)

Solder pin length (l): 3.2 mm, tinned, Black, Box

#### SLD 3.50V/90G

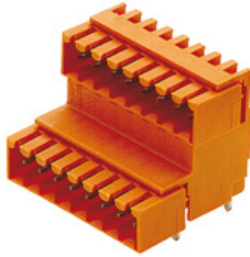

Double-level, staggered pin header for wave soldering at 3.50 mm pitch. They are available in closed and flanged versions. The male connectors provide space for labelling and can be coded.

#### General ordering data

Type	Order No.	Version	GTIN (EAN)	Qty.	Product data	Packaging
SLD	<a href="#">1642290000</a>	PCB plug-in connector, male	4008190280819	10 pc(s).	IEC: 200 V / 10.5 A	Box
3.50V/24/90G		header, closed side, Solder connection, 3.50 mm, No. of poles: 24, 90°, Solder pin length (l): 3.2 mm, tinned, Orange, Box			UL: 300 V / 8 A	
3.2SN OR BX						

#### SL-THR 3.5/135F



**High-temperature-resistant male header, 3.50 mm pitch.**

- **Plugging direction parallel (90°), straight 180° or angled (135°) to PCB**
- **Housing variants: closed side (G), screw flange (F), solder flange (LF) or snap-on solder flange (RF)**
- **Optimised for the SMT process**
- **Pin length 3.2 mm universal for all soldering methods**
- **Pin length 1.5 mm optimised for reflow soldering methods**
- **Packed either in a box (BX) or tape-on-reel (RL)**
- **Male header can be coded**

#### General ordering data

Type	Order No.	Version	GTIN (EAN)	Qty.	Product data	Packaging
SL-SMT	<a href="#">1003620000</a>	PCB plug-in connector, male	4032248700240	50 pc(s).	IEC: 320 V / 15 A	Box
3.50/12/135F		header, Flange, Reflow solder connection, 3.50 mm, No. of poles: 12, 135°, Solder pin length (l): 3.2 mm, tinned, Black, Box			UL: 300 V / 10 A	
3.2SN BK BX						

**OMNIMATE Signal - series BL/SL 3.50  
BL 3.50/12/270 SN OR BX**

**Weidmüller Interface GmbH & Co. KG**  
Klingenbergstraße 16  
D-32758 Detmold  
Germany  
Fon: +49 5231 14-0  
Fax: +49 5231 14-292083  
www.weidmuller.com

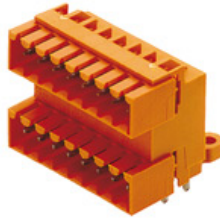
**Mating connector (fully pluggable)**
**SLD 3.50/90G**

Two-tier pin header for wave soldering in 3.50 mm pitch. The connector is available in open, closed and flange versions. The male connectors provide space for labelling and can be coded. Packed in a cardboard box.

**General ordering data**

Type	Order No.	Version	GTIN (EAN)	Qty.	Product data	Packaging
SLD	<a href="#">1633680000</a>	PCB plug-in connector, male	4008190258139	10 pc(s).	IEC: 200 V / 10.5 A UL: 300 V / 8 A	Box
3.50/24/90G		header, closed side, Solder connection, 3.50 mm, No. of poles: 24, 90°, Solder pin length (l): 3.2 mm, tinned, Orange, Box				
3.2SN OR BX						

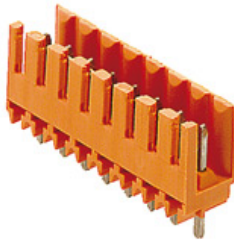
**SL 3.50/180**

Pin headers for wave soldering in 3.50 mm pitch

- Plugging direction is parallel (90°), straight 180° or angled (135°) to the PCB
- Housing variant: screw flange (F)
- Packed in a cardboard box (BX)
- Pin header can be coded

**General ordering data**

Type	Order No.	Version	GTIN (EAN)	Qty.	Product data	Packaging
SL	<a href="#">1604870000</a>	PCB plug-in connector, male header, open side, Solder connection, 3.50 mm, No. of poles: 12, 180°, Solder pin length (l): 3.2 mm, tinned, Orange, Box	4008190111427	50 pc(s).	IEC: 320 V / 17 A UL: 300 V / 10 A	Box
3.50/12/180						
3.2SN OR BX						

**OMNIMATE Signal - series BL/SL 3.50  
BL 3.50/12/270 SN OR BX**

**Weidmüller Interface GmbH & Co. KG**  
Klingenbergstraße 16  
D-32758 Detmold  
Germany  
Fon: +49 5231 14-0  
Fax: +49 5231 14-292083  
www.weidmueller.com

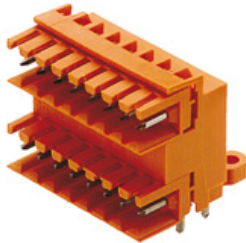
**Mating connector (fully pluggable)**
**SLD 3.50/90**

Two-tier pin header for wave soldering in 3.50 mm pitch. The connector is available in open, closed and flange versions. The male connectors provide space for labelling and can be coded. Packed in a cardboard box.

**General ordering data**

Type	Order No.	Version	GTIN (EAN)	Qty.	Product data	Packaging
SLD	<a href="#">1633450000</a>	PCB plug-in connector, male	4008190257903	10 pc(s).	IEC: 200 V / 10.5 A UL: 300 V / 8 A	Box
3.50/24/90		header, open side, Solder connection, 3.50 mm, No. of poles: 24, 90°, Solder pin length (l): 3.2 mm, tinned, Orange, Box				
3.2SN OR BX						

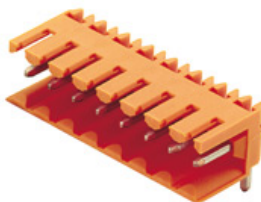
**SL 3.50/90**

Pin headers for wave soldering in 3.50 mm pitch

- Plugging direction is parallel (90°), straight 180° or angled (135°) to the PCB
- Housing variant: screw flange (F)
- Packed in a cardboard box (BX)
- Pin header can be coded

**General ordering data**

Type	Order No.	Version	GTIN (EAN)	Qty.	Product data	Packaging
SL	<a href="#">1597310000</a>	PCB plug-in connector, male	4008190018283	50 pc(s).	IEC: 320 V / 17 A UL: 300 V / 10 A	Box
3.50/12/90		header, open side, Solder connection, 3.50 mm, No. of poles: 12, 90°, Solder pin length (l): 3.2 mm, tinned, Orange, Box				
3.2SN OR BX						

**OMNIMATE Signal - series BL/SL 3.50  
BL 3.50/12/270 SN OR BX**

**Weidmüller Interface GmbH & Co. KG**  
Klingenbergstraße 16  
D-32758 Detmold  
Germany  
Fon: +49 5231 14-0  
Fax: +49 5231 14-292083  
www.weidmueller.com

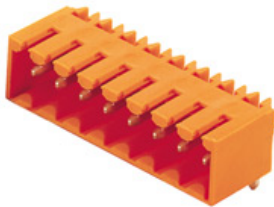
**Mating connector (fully pluggable)**
**SL 3.50/90G**

Pin headers for wave soldering in 3.50 mm pitch

- Plugging direction is parallel (90°), straight 180° or angled (135°) to the PCB
- Housing variant: screw flange (F)
- Packed in a cardboard box (BX)
- Pin header can be coded

**General ordering data**

Type	Order No.	Version	GTIN (EAN)	Qty.	Product data	Packaging
SL	<a href="#">1605170000</a>	PCB plug-in connector, male	4008190096342	50 pc(s).	IEC: 320 V / 17 A	Box
3.50/12/90G		header, closed side, Solder connection, 3.50 mm, No. of poles: 12, 90°, Solder pin length (l): 3.2 mm, tinned, Orange, Box			UL: 300 V / 10 A	
3.2SN OR BX						

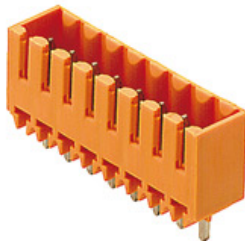
**SL 3.50/180G**

Pin headers for wave soldering in 3.50 mm pitch

- Plugging direction is parallel (90°), straight 180° or angled (135°) to the PCB
- Housing variant: screw flange (F)
- Packed in a cardboard box (BX)
- Pin header can be coded

**General ordering data**

Type	Order No.	Version	GTIN (EAN)	Qty.	Product data	Packaging
SL	<a href="#">1604570000</a>	PCB plug-in connector, male header, closed side, Solder connection, 3.50 mm, No. of poles: 12, 180°, Solder pin length (l): 3.2 mm, tinned, Orange, Box	4008190031572	50 pc(s).	IEC: 320 V / 17 A	Box
3.50/12/180G					UL: 300 V / 10 A	
3.2SN OR BX						

# Adressen weltweit

Let's connect.

- AE Vereinigte Arabische Emirate**  
Weidmüller Middle East FZE  
Warehouse Q3-79  
SAIF-Zone  
P.O. BOX 8591  
Sharjah  
Telefonnummer +971 65572723  
Faxnummer +971 65572724  
wme.info@weidmuller.com
- AO Angola**  
Bitte kontaktieren Sie  
Phambili Interface  
Südafrika
- AR Argentinien**  
CPI SA  
Bauness 2660  
C1431DOF Buenos Aires  
Telefonnummer +54 11 4523 8008  
Faxnummer +54 11 4522 0546  
info@cpi.com.ar  
www.cpi.com.ar
- AT Österreich**  
Weidmüller GmbH  
IZ NOE Süd Straße 2b, Obj  
M 59  
2355 Wiener Neudorf  
Telefonnummer +43 2236 67080  
Faxnummer +43 2236 6708-899  
office.at@weidmuller.com  
www.weidmuller.com
- AU Australia**  
Weidmüller Pty. Ltd.  
PO BOX 6944  
Huntingwood 2148  
Huntingwood Drive 43  
Huntingwood NSW 2148  
Telefonnummer +61 2 9671 9999  
Faxnummer +61 2 9671 9911  
info@weidmuller.com.au  
www.weidmuller.com.au
- AZ Aserbaidtschan**  
Repräsentanz Büro  
Rashad Mahmudov  
Demirchi Tower, 4th floor  
37, Khojali ave.  
AZ 1025 Baku  
Telefonnummer +994 12 488 80 36  
Faxnummer +994 12 488 80 37  
rashad.mahmudov@weidmuller.com
- BA Bosnien und Herzegowina**  
Bitte kontaktieren Sie  
unser Representative Office  
Weidmüller Interface GmbH  
& Co. KG  
Serbien  
  
oder  
  
BIG electric d.o.o  
Mladena Stojanovića 117A  
78000 Banja Luka  
Telefonnummer +387 51926277  
Faxnummer +387 51926277  
bigelectric@blic.net  
www.bigelectric.ba
- BE Belgien**  
Weidmüller Benelux B. V.  
Mechelsesteenweg 519 bus  
6 an 7  
1930 Nossegem  
Telefonnummer +32 2 752 40 70  
Faxnummer +32 2 751 36 06  
info@weidmuller.be  
www.weidmuller.be
- BG Bulgarien**  
Weid-Bul EOOD  
Bul. "Kliment Ohridski" 13  
1756 Sofia  
Telefonnummer +359 2 963 2560  
Faxnummer +359 2 963 1098  
sofia@weidbul.com  
www.weidbul.com
- BH Bahrain**  
Khayber Trading Company  
P.O Box 1976  
Manama  
Telefonnummer +973 720747  
Faxnummer +973 720331  
khayber@batelco.com.bh
- BR Brasilien**  
Weidmüller Conexel do Brasil  
Conexões Elétricas Ltda.  
Av. Presidente Juscelino, 642  
- Piraporinha  
Diadema, São Paulo  
09950-370  
Telefonnummer +55 (11) 4366-9600  
Faxnummer +55 (11) 4362-1677  
vendas@weidmuller.com.br  
www.weidmuller.com.br
- BW Botswana**  
Bitte kontaktieren Sie  
Phambili Interface  
Südafrika
- BY Weißrussland**  
TECHNIKON Ltd.  
Lomnického 5/1705  
Nezavisimosti pr. 177-9  
220125 Minsk  
Telefonnummer +375 17 393-11-77  
Faxnummer +375 17 3930080  
wm@technikon.by
- CA Kanada**  
W Interconnections Canada  
Inc.  
10 Spy Court  
Markham Ontario L3R 5H6  
Telefonnummer +1 (905) 475-1507 Ext. 9836  
Faxnummer +1 (905) 475-2798  
support@weidmuller.ca  
www.weidmuller.ca
- CG Kongo**  
Bitte kontaktieren Sie  
Phambili Interface  
Südafrika
- CH Schweiz**  
Weidmüller Schweiz AG  
Rundbuckstraße 2  
8212 Neuhausen am  
Rheinfall SH  
Telefonnummer +41 52 674 07 07  
Faxnummer +41 52 674 07 08  
info@weidmuller.ch  
www.weidmuller.ch
- CL Chile**  
ATS - INTECH  
Maria Luisa Santander 0475  
Santiago  
Providencia 7500859  
Telefonnummer +56 2 341 1271  
Faxnummer +56 2 341 1275  
felipe@atsintech.com  
www.atsintech.com  
  
CPI CHILE LTDA  
Av. Presidente Frei Montalva  
6001, 47 complejo el cortijo  
Santiago - Conchalí  
Telefonnummer +562 963 8440  
cpi@cpichile.cl  
www.cpicchile.cl
- CN China**  
Weidmüller Interface  
(Shanghai) Co. Ltd.  
100 Yutong Road  
25 F, BM Intercontinental  
Business Center  
200070 Shanghai  
Telefonnummer +86 21-22195008  
Faxnummer +86 512-68417505  
customer.hotline@weidmuller.com.cn  
www.cnweidmuller.com
- CO Kolumbien**  
Automatización Avanzada  
S. A.  
Carrera 97 No., 24 c - 23  
Bodega 4  
110911 Bogotá-D.C.  
Telefonnummer +57 (1) 547-8510  
Faxnummer +57 (1) 422-3044  
comercial@automatizacionavanzada.com  
www.automatizacionavanzada.com
- CR Costa Rica**  
ELVATRON S. A.  
la Uruca 400 Norte Banco  
Costa Rica  
San Jose Costa Rica  
Telefonnummer +506 2961-060  
Faxnummer +506 5200-609  
dirk.haase@elvatron.com  
www.elvatron.com
- CZ Tschechische Republik**  
Weidmüller s.r.o.  
Lomnického 5/1705  
140 00 Praha 4  
Telefonnummer +420 244 001 400  
Faxnummer +420 244 001 499  
office@weidmuller.cz  
www.weidmuller.cz
- DE Deutschland**  
Weidmüller GmbH & Co. KG  
Ohmstraße 9  
32758 Detmold  
Postfach 30 54  
32720 Detmold  
Telefonnummer +49 5231 1428-0  
Faxnummer +49 5231 14-292083  
weidmuller@weidmuller.de  
www.weidmuller.de
- DK Dänemark**  
Weidmüller Danmark  
Vallensbækvej 18A  
2605 Brøndby  
Telefonnummer +45 27747800  
kundeservice@weidmuller.dk  
www.weidmuller.dk
- DZ Algerien**  
SARL INTER ELECTRIC  
1a Angles des Rues Okba Ibn  
Nafaa et Hassi Beida  
2300 Annaba  
Telefonnummer  
Faxnummer  
contact@inter-electric.com
- EC Ecuador**  
Elsystec S. A., Electricidad  
Sistemas y Tecnología  
Vasco de Contreras N35-251  
y Manosca  
Quito - Pichincha  
Telefonnummer +593 22456510  
Faxnummer +593 22456755  
Elsystec@uio.satnet.net
- EE Estland**  
Bitte kontaktieren Sie  
unser Representative Office  
Weidmüller Interface GmbH  
& Co. KG  
Lettland  
  
oder  
  
Soots Interface OÜ  
Pärnu mnt 142  
11317 Tallinn  
Telefonnummer +372 609 6933  
Faxnummer  
info@sootsinterface.ee  
www.sootsinterface.ee
- EG Ägypten**  
Standard Electric (OMEGA)  
1, Abdelhamid Badawy Street  
Heliopolis  
Cairo  
Telefonnummer +202 21805600  
stdelec@rite.com
- ES Spanien**  
Weidmüller, S. A.  
Narcís Monturiol 11-13, Pol.  
Ind. Sudoeste  
8960 Sant Just  
Desvern - Barcelona  
Telefonnummer +34 934 803 386  
Faxnummer +34 933 718 055  
weidmuller@weidmuller.es  
www.weidmuller.es
- FI Finnland**  
Weidmüller Suomi,  
Weidmüller Aktiebolagetin  
sivuliike  
Koy Plaza Vivace  
Äyritie 8C  
FI 15100 Vantaa  
Telefonnummer +358 20 7351300  
Faxnummer +358 800 114 667  
asiakaspalvelu@weidmuller.fi  
www.weidmuller.fi
- FR Frankreich**  
Weidmüller E. U. R. L.  
12, Chaussée Jules César  
BP 263 Osny  
95523 Cergy-Pontoise Cedex  
Telefonnummer +33 1 34 24 55 00  
Faxnummer +33 1 34 24 55 01  
mail@weidmuller.fr
- GB Großbritannien**  
Weidmüller Ltd.  
Klippon House  
Centurion Court Office Park,  
Meridian East, Meridian  
Business Park  
Leicester  
LE19 1TP  
Telefonnummer +44 116 282 3470  
Faxnummer +44 116 289 3582  
marketing@weidmuller.co.uk  
www.weidmuller.co.uk
- GE Georgien**  
Bitte kontaktieren Sie  
unser Representative Office  
Rashad Mahmudov  
Aserbaidtschan.
- GH Ghana**  
Bitte kontaktieren Sie  
Weidmüller Interface GmbH  
& Co. KG  
Südafrika
- GR Griechenland**  
G.A. Solutions  
Ippokratous 11 Metamorfosi  
144 52 Athen  
Telefonnummer +30 210 2823233  
Faxnummer +30 210 2823233  
info@weidmuller.gr  
www.weidmuller.gr
- GT Guatemala**  
Prestelectro, Prestegard  
Electro, S.A.  
Avenida Petapa 44-22,  
Zona 12  
Guatemala City  
Telefonnummer +502 2442-3346  
Faxnummer +502 2476-8945  
ventas@prestelectro.com
- HK Hong Kong**  
Weidmüller (Hong Kong)  
Limited Co. Ltd.  
Unit 1617, Metropolis Tower  
No. 10 Metropolis Drive,  
Hungghom, Kowloon  
Telefonnummer +852 3154 8088  
Faxnummer +852 31548099  
Info-hk@weidmuller.com.hk
- HR Kroatien**  
ElektroPARTNER d.o.o.  
Slavonska avenija 24/6  
HR-10000 Zagreb  
Telefonnummer +385 (1) 6184 793  
Faxnummer +385 (1) 6184 795  
elektropartner@zg.t-com.hr  
www.elektropartner.hr
- HU Ungarn**  
Weidmüller Kereskedelmi Kft.  
Budapest  
Gubacsi út 6.  
1097  
Telefonnummer +36 1 382 7700  
Faxnummer +36 1 382 7701  
info@weidmuller.hu  
www.weidmuller.hu
- ID Indonesien**  
PT. Nego Electrindo  
Ruko Mega Grosir Cempaka  
Mas Blok I No. 20 – 22  
Jakarta 10640  
Telefonnummer +62 21 42882255  
Faxnummer +62 21 42882266  
sales@negoelectrindo.co.id
- IE Irland**  
Bitte kontaktieren Sie  
Weidmüller Ltd.  
Großbritannien
- IL Israel**  
A. U. Shay Ltd.  
23/25, Embar Street  
49222 Petach-Tikva  
P.O. Box 1 00 49  
49222 Petach-Tikva  
Telefonnummer +972 3-923-3601  
Faxnummer +972 3-923-4601  
shay@uriel-shay.com  
www.uriel-shay.com  
  
ATEKA Ltd.  
4, Ha Tavor lane Industrial  
area Segula  
49691 Petach-Tikva  
P.O. Box 4710  
Petach-Tikva  
Telefonnummer +972 73-200-1311  
Faxnummer +972 3-924 4245  
marketing@ateka.co.il  
www.ateka.co.il
- IN Indien**  
Repräsentanz Büro  
Weidmüller Electronics India  
Pvt. Ltd.  
12th Lane North Avenue, Opp  
Joggers Park,  
Kalyani Nagar, Pune  
411 006  
Telefonnummer +91 20-41290090  
wmi.pune@weidmuller.in  
www.weidmuller.com
- IS Island**  
Samey Automation Center  
Lyngas 13  
210 Garoabaer  
Telefonnummer +354 510 5200  
Faxnummer +354 510 5201  
Samey@samey.is  
www.samey.is
- IT Italien**  
Weidmüller S. r.l.  
Via Albert Einstein 4  
20092 Cinisello  
Balsamo Milano  
Telefonnummer +39 02 660681  
Faxnummer +39 02 6124945  
weidmuller@weidmuller.it  
www.weidmuller.it
- JM Jamaika**  
Bitte kontaktieren Sie  
W Interconnections Inc.  
USA
- JO Jordanien**  
Trans Jordan for Electro  
PO Box 33 06 07  
Amman  
Telefonnummer +962 6 533 2020  
Faxnummer +962 6 533 5800  
transjordan@batelco.jo



Alle Weidmüller Adressen sowie Ihren lokalen Ansprechpartner finden Sie im Internet unter: [www.weidmueller.com/countries](http://www.weidmueller.com/countries)

Vertriebsgesellschaft   
 Auslandsvertretung   
 ohne Auslandsvertretung 

Let's connect.

- JP Japan**  
 Nihon Weidmüller Co. Ltd.  
 Sphere Tower Tennoz 2-2-8  
 Higashi-Shinagawa,  
 Shinagawa-ku  
 Tokyo  
 140-0002  
 Telefonnummer +81 3 6711  
 5300  
 Faxnummer +81 3 6711  
 5333  
[weidmullerjapan@weidmuller.co.jp](mailto:weidmullerjapan@weidmuller.co.jp)  
[www.weidmuller.co.jp](http://www.weidmuller.co.jp)
- KE Kenia**  
 Bitte kontaktieren Sie  
 Phambili Interface  
 Südafrika
- KR Korea**  
 Weidmüller Korea Co. Ltd.  
 9th floor, Wonbang B/D  
 Samseong 2-Dong, Gangnam-  
 Gu  
 Seoul 143-42  
 Telefonnummer +82 2-516-  
 0003  
 Faxnummer +82 2-516-0090  
[info@weidmuller.co.kr](mailto:info@weidmuller.co.kr)  
[www.weidmuller.co.kr](http://www.weidmuller.co.kr)
- KW Kuwait**  
 Kana Controls General Trading  
 & Contracting Co. W. L. L.  
 Al Rai Industrial Area, Plot  
 28-30, St. 31  
 13016 Safat  
 B.P. 25593  
 Telefonnummer +965  
 4741373  
 Faxnummer +965 4741537  
[info@kanacontrols.com](mailto:info@kanacontrols.com)
- KZ Kasachstan**  
 Bitte kontaktieren Sie  
 OOO Weidmüller  
 Russland
- LB Libanon**  
 Progress Engineering &  
 Trading Enterprises  
 Al Nahr Street  
 Beirut 11-1111  
 Telefonnummer +961 1  
 444 664  
 Faxnummer +961 1 561 880  
[progress@inco.com.lb](mailto:progress@inco.com.lb)
- LT Litauen**  
 Bitte kontaktieren Sie  
 unser Representative Office  
 Weidmüller Interface GmbH  
 & Co. KG  
 Lettland  
 oder  
 ELEKTROS IRANGA  
 Tinklu g. 29 a  
 LT-5319 Panevezys  
 Telefonnummer +370 (45)  
 582 828  
 Faxnummer  
[info@eliranga.lt](mailto:info@eliranga.lt)
- LU Luxemburg**  
 Bitte kontaktieren Sie  
 Weidmüller Benelux B. V.  
 Niederlande
- LV Lettland**  
 SIA Abi4  
 Daugavgrivas 31b  
 Riga, LV-1007  
 Telefonnummer +371 674  
 70999  
 Faxnummer +371 676  
 24562  
[abi\\_4@tvnet.lv](mailto:abi_4@tvnet.lv)  
 Repräsentanz Büro  
 Weidmüller Interface GmbH  
 & Co. KG  
 Udens str. 12-118  
 Riga, LV-1007  
 Telefonnummer +371  
 29254766  
 Faxnummer +371 674  
 65637  
[ilgonis.rudaks@weidmueller.com](mailto:ilgonis.rudaks@weidmueller.com)  
[www.weidmueller.com](http://www.weidmueller.com)
- MA Marokko**  
 Sofimed  
 137, Bd Moulay Ismail Roches  
 Noires  
 20290 Casablanca  
 Telefonnummer  
 Faxnummer  
[contact@sofimedmaroc.com](mailto:contact@sofimedmaroc.com)
- MD Moldawien**  
 BERHORD A & D srl  
 79/1, str. Milescu Spartaru  
 MD-2075 Chisinau  
 Moldova  
 Telefonnummer +373 (22)  
 815002  
 Faxnummer +373 (22)  
 815007  
[atuleanu@berhord.com](mailto:atuleanu@berhord.com)  
[www.ad.berhord.com](http://www.ad.berhord.com)
- ME Montenegro**  
 Bitte kontaktieren Sie  
 unser Representative Office  
 Weidmüller Interface GmbH  
 & Co. KG  
 Serbien.
- MG Madagaskar**  
 Bitte kontaktieren Sie  
 Phambili Interface  
 Südafrika
- MK Mazedonien**  
 Bitte kontaktieren Sie  
 unser Representative Office  
 Weidmüller Interface GmbH  
 & Co. KG  
 Serbien  
 oder  
 ELEKTRO - SMK doool  
 UL. III Makedonska brigada  
 b.b.  
 1000 Skopje  
 Telefonnummer +389  
 22460295  
 Faxnummer  
[Elektro-smk@tekelelab.net.mk](mailto:Elektro-smk@tekelelab.net.mk)
- MT Malta**  
 E. S. S., Electrical Supplies &  
 Services Ltd.  
 San Gwakkin Road  
 Mriehel  
 Telefonnummer +356  
 21255777  
 Faxnummer +356 2 1255999  
[robert.agius@ess.com.mt](mailto:robert.agius@ess.com.mt)
- MU Mauritius**  
 Mubelo Electrical Ltd.  
 Office 26, Gateway building,  
 St. Jean Road  
 Quatre Bornes  
 Mauritius  
 Telefonnummer +230  
 4670989  
 Faxnummer +230 4654051  
[richard.mubelo@orange.mu](mailto:richard.mubelo@orange.mu)
- MW Malawi**  
 Bitte kontaktieren Sie  
 Phambili Interface  
 Südafrika
- MX Mexiko**  
 W Interconnections S. A.  
 DE C. V.  
 Blvd. Hermanos Serdán 698,  
 Col. San Rafael Oriente  
 72029 Puebla  
 Telefonnummer +52 (222)  
 268 6227  
 Faxnummer +52 (222) 286  
 6242  
[clientes@weidmuller.com.mx](mailto:clientes@weidmuller.com.mx)
- MY Malaysia**  
 Connect Plus Technology  
 Sdn Bhd  
 No. 43, Jalan PJS 11/22,  
 Bandar Sunway  
 46150 Petaling Jaya  
 Selangor Darul Ehsan  
 Telefonnummer +60 3 5633  
 7363  
 Faxnummer +60 3 5633  
 6562  
[paul@cptech.com.my](mailto:paul@cptech.com.my)  
[www.cptech.com.my](http://www.cptech.com.my)
- MZ Mosambik**  
 Bitte kontaktieren Sie  
 Phambili Interface  
 Südafrika
- NA Namibia**  
 Bitte kontaktieren Sie  
 Phambili Interface  
 Südafrika
- NG Nigeria**  
 Bitte kontaktieren Sie  
 Weidmüller Interface GmbH  
 & Co. KG  
 Südafrika
- NL Niederlande**  
 Weidmüller Benelux B. V.  
 Franciscusweg 221  
 1216 SE Hilversum  
 Postfach 1505  
 1200 BM Hilversum  
 Telefonnummer +31 35 626  
 12 61  
 Faxnummer +31 35 623  
 20 44  
[info@weidmuller.nl](mailto:info@weidmuller.nl)  
[www.weidmuller.nl](http://www.weidmuller.nl)
- NO Norwegen**  
 Sivilingeniør J.F. Knudtzen AS  
 Billingstadletta 97  
 1396 Billingstad  
 PO Box 160  
 1378 Nesbru  
 Telefonnummer +47 66 98  
 33 50  
 Faxnummer +47 66 98 09 55  
[firmapost@fknudtzen.no](mailto:firmapost@fknudtzen.no)  
[www.fknudtzen.no](http://www.fknudtzen.no)
- NZ Neuseeland**  
 Cuthbert S. Steward Ltd.  
 27 Te Puni Street  
 Petone  
 PO Box 38496  
 Wellington Mail Centre 5054  
 Telefonnummer (04) 568  
 6156  
 Faxnummer (09) 489 1752  
[cslak@cuthbertstewart.co.nz](mailto:cslak@cuthbertstewart.co.nz)  
 Cuthbert S. Steward Ltd  
 4 Fred Thomas Drive  
 Aon Building, Ground Floor,  
 South Entry  
 Takapuna  
 PO Box 100 338  
 North Shore City 745  
 Telefonnummer (09) 489  
 1751  
 Faxnummer (04) 568 6056  
[cslak@cuthbertstewart.co.nz](mailto:cslak@cuthbertstewart.co.nz)
- OM Oman**  
 DAN INTERNATIONAL LLC.  
 Ghala St. 111  
 BP 2901  
 Seeb  
 Telefonnummer +968  
 5036 77  
 Faxnummer +968 5037 55  
[yeidu@danintl.com](mailto:yeidu@danintl.com)
- PE Peru**  
 IMPEXINCA S.A.C.  
 Calle Ortiz de Zevallos No.  
 105, Urb. San Antonio  
 18  
 Lima, Miraflores  
 Telefonnummer +51 1 447  
 5608  
[info@impexinca.pe](mailto:info@impexinca.pe)  
[www.impexinca.pe](http://www.impexinca.pe)  
 J & W CIA. S. A.  
 Calle 6 Mz. D Lte. 23, Urb.  
 Ind. Grimanesa  
 01  
 Callao  
 Telefonnummer +51 1 572  
 2539  
 Faxnummer +51 1 572 0152  
[contacto@jwcia.com](mailto:contacto@jwcia.com)  
[www.jwcia.com](http://www.jwcia.com)
- PH Philippinen**  
 Enclosure Systems Specialists  
 Inc.  
 2276 Don Chino Roces  
 Avenue Extension  
 Room 103/105 Narra Building  
 1231 Makati City  
 Telefonnummer +63 2 813  
 8580  
 Faxnummer +63 2 813 8596  
[sales\\_encsys@pltdsl.net](mailto:sales_encsys@pltdsl.net)  
[www.enclosuresystemspsh.com](http://www.enclosuresystemspsh.com)
- PK Pakistan**  
 Automation Controls (Pak)  
 Apartment No. 33 C III,  
 Chenab Block, Allama Iqbal  
 Town  
 Lahore  
 Telefonnummer +92 42  
 37809948  
 Faxnummer +92 42  
 37809950  
[nadeem@acpak.com.pk](mailto:nadeem@acpak.com.pk)  
[www.acpak.com.pk](http://www.acpak.com.pk)
- PL Polen**  
 Weidmüller Sp. z o. o.  
 ul. Ogrodowa 58  
 00-876 Warszawa  
 Telefonnummer +48 22 510  
 09 40  
 Faxnummer +48 22 510  
 09 41  
[biuro@weidmuller.com.pl](mailto:biuro@weidmuller.com.pl)  
[www.weidmuller.pl](http://www.weidmuller.pl)
- PR Puerto Rico**  
 Bitte kontaktieren Sie  
 W Interconnections Inc.  
 USA
- PT Portugal**  
 Weidmüller Sistemas de  
 Interface S. A.  
 Estrada Outeiro Polima, R.  
 Augusto Dias da Silva, Lote  
 B - Esct. 2  
 São Domingos de Rana  
 2785-515 Abóboda  
 Telefonnummer +351 214  
 459 191  
 Faxnummer +351 214  
 455 871  
[weidmuller@weidmuller.pt](mailto:weidmuller@weidmuller.pt)  
[www.weidmuller.pt](http://www.weidmuller.pt)
- PY Paraguay**  
 Bitte kontaktieren Sie  
 CPI SA  
 Argentinien
- QA Katar**  
 Doha Motors  
 PO Box 145  
 Telefonnummer +974  
 4651441  
 Faxnummer +974 4654579  
[dmtctech@qatar.net.qa](mailto:dmtctech@qatar.net.qa)  
<http://www.dohamotorsgroup.com/td.html>
- RO Rumänien**  
 Repräsentanz Büro  
 Weidmüller Interface GmbH  
 & Co. KG  
 Ionescu Crum Street, No.  
 1, 1st Tower, 1st Floor,  
 Office 4  
 500446 Brasov - Brasov  
 Business Park  
 Telefonnummer +40 (268)  
 446 222  
 Faxnummer +40 (262)  
 205 410  
[claudiu.totea@weidmueller.com](mailto:claudiu.totea@weidmueller.com)  
[www.weidmueller.com](http://www.weidmueller.com)
- RS Serbien**  
 Repräsentanz Büro  
 Weidmüller Interface GmbH  
 & Co. KG  
 Ustanicka 189, III sprat  
 lokal 7a  
 11050 Beograd  
 Telefonnummer +381  
 112885274  
 Faxnummer +381  
 112885274  
[zoran.rabrenovic@weidmueller.com](mailto:zoran.rabrenovic@weidmueller.com)  
 TeLa Elektrik d.o.o.  
 Ul. Dr Drage Ljočić 6  
 Beograd  
 Telefonnummer +381 11  
 2772 415  
 Faxnummer +381 11 2772  
 850  
[office@tela.rs](mailto:office@tela.rs)  
[www.tela.rs](http://www.tela.rs)
- RU Russland**  
 OOO Weidmüller  
 Warshavskoye highway, 25  
 A. bld. 6  
 Moskau  
 117105  
 Telefonnummer +7 (495)  
 771-69-40  
 Faxnummer +7 (495) 771-  
 69-41  
[Info@weidmueller.ru](mailto:Info@weidmueller.ru)  
[www.weidmueller.ru](http://www.weidmueller.ru)
- SA Saudi-Arabien**  
 Al Abdulkarim Holding Co.  
 P.O. Box 4  
 Dammam 31411  
 Telefonnummer +966 3  
 8337110  
 Faxnummer +966 3  
 8829547  
 E-Mail [salehsk@akh.com.sa](mailto:salehsk@akh.com.sa)  
[www.weidmueller.ae](http://www.weidmueller.ae)  
 Saudi Electric Supply  
 Company (SESCO)  
 P.O. Box 32 98  
 Al Khobar 31952  
 Telefonnummer +966 3  
 8829546 Ext. 3030  
 Faxnummer  
[www.sesco-gex.com](mailto:www.sesco-gex.com)  
[www.sesco-gex.com](http://www.sesco-gex.com)
- SE Schweden**  
 Weidmüller AB  
 Axel Danielssons väg 271  
 BOX 31025  
 SE-200 49 Malmö  
 Telefonnummer +46 77-143  
 00 44  
 Faxnummer +46 40-37 48 60  
[info@weidmuller.se](mailto:info@weidmuller.se)  
[www.weidmuller.se](http://www.weidmuller.se)
- SG Singapur**  
 Weidmüller Pte. Ltd.  
 70 Bendemeer Road  
 # 04-03 Luzerne Building  
 Singapore 339940  
 Telefonnummer +65 6841  
 5311  
 Faxnummer +65 6841 5377  
[info@weidmuller.com.sg](mailto:info@weidmuller.com.sg)  
[www.weidmuller.com.sg](http://www.weidmuller.com.sg)
- SI Slowenien**  
 Elektrospoji d. o. o.  
 Stegne 27  
 SI- 1000 Ljubljana  
 Osrednjlesjovska  
 Telefonnummer +386 1 511  
 3810  
 Faxnummer +386 1 511  
 1604  
[info@elektrospoji.si](mailto:info@elektrospoji.si)  
[www.elektrospoji.si](http://www.elektrospoji.si)
- SK Slowakei**  
 ELEKTRIS s.r.o.  
 Elektrárenská 1  
 831 04 Bratislava  
 Telefonnummer +421 2/4920  
 0113  
 Faxnummer +421 2/4920  
 0119  
[bratislava@elektris.sk](mailto:bratislava@elektris.sk)
- SV El Salvador**  
 Prestegard Electro  
 11 Avenida Norte No. 240  
 Edificio Salazar No. 2  
 San Salvador  
 Telefonnummer +503 2271  
 1690  
 Faxnummer +503 2221  
 3851  
[prestegard@navegante.com.sv](mailto:prestegard@navegante.com.sv)
- SY Syrien**  
 Bitte kontaktieren Sie  
 Weidmüller Middle East FZE  
 Vereinigte Arabische Emirate
- SZ Swasiland**  
 Bitte kontaktieren Sie  
 Phambili Interface  
 Südafrika

# Adressen weltweit

Let's connect.

**TH Thailand**  
Pisanu Engineering Co. Ltd.  
Kwang Dingaeng, Khet  
Dingaeng  
800/2 Soi Trakulsuk, Asoke-  
dindaeng Road  
Dindaeng, Bangkok  
10400  
Telefonnummer +66 2 248  
2896  
Faxnummer +662 105 6301  
ecsales@pisanu.co.th  
www.pisanu.co.th

Repräsentanz Büro  
Weidmüller Pte. Ltd.  
37/F, Sathorn Square Building  
98 North Sathorn Road  
Bangkok, Silom Bangrak  
10500  
Telefonnummer +66 2 105  
6300  
Faxnummer +66 2 642 9220  
info@weidmuller.com.sg

**TN Tunesien**  
Bitte kontaktieren Sie  
Weidmüller E. U. R. L.  
Frankreich

**TR Türkei**  
Weidmüller Elektronik Ticaret  
Ltd. Sirketi  
Kavacik Mah. Orhan Veli Kanik  
Caddesi 9/1  
34810 Beykoz / Istanbul  
Telefonnummer +90 (216)  
537 10 70  
Faxnummer +90 (216) 537  
10 77  
info@weidmuller.com.tr  
www.weidmuller.com.tr

**TW Taiwan**  
Weidmuller (Hong Kong)  
Limited  
No. 3, Lane 89, ChungYang  
N. Rd  
24148 SanChuang City,  
Taipei  
Telefonnummer +886 921  
949 751  
roy.lin@weidmueller.com.hk

**TZ Tansania**  
Bitte kontaktieren Sie  
Phambili Interface  
Südafrika

**UA Ukraine**  
LLC WM UKRAINE  
Levanevskogo str. 6  
Kiev  
3058  
Telefonnummer +38 044  
490 32 48  
Faxnummer  
info@wm-ua.com.ua  
wm-ua.com.ua/  
Repräsentanz Büro  
Weidmueller Interface GmbH  
& Co. KG  
Z, office 303  
7-D, Zdolbunivska str.  
Kiev, 2081  
Telefonnummer (Mobil) +38  
050 440 25 24  
info.ua@weidmueller.com

**US USA**  
W Interconnections Inc.  
821 Southlake Boulevard  
Richmond Virginia 23236  
Telefonnummer +1 (804)  
794-2877  
Faxnummer +1 (804) 379-  
2593  
info@weidmuller.com  
www.weidmuller.com

**UY Uruguay**  
REWO Uruguay S. A.  
AV. Bolivia 2001 Esq  
Rocafuerte  
11300 Carrasco Montevideo  
Telefonnummer +598 2604  
8439  
Faxnummer +598 2604  
8439  
rewo@rewo Uruguay.com.uy

**UZ Usbekistan**  
Bitte kontaktieren Sie  
OOO Weidmüller  
Russland

**VE Venezuela**  
Somerinca C. A.  
Corazon de Jesus - 3ra  
Transversal con calle el  
Carmen- Los Dos Caminos  
Caracas 1070-A  
Telefonnummer +58  
2122352748  
Faxnummer +58  
2122399341  
klocmoeller@cantv.net  
www.somerinca.com

**VN Vietnam**  
AUMI Industrial Equipment &  
Automation Company Limited  
E1, La Thanh Hotel  
218 Doi Can Street  
Lieu Giai Ward, Ba Dinh  
District  
Hanoi City  
Telefonnummer +84 4  
37628601  
Faxnummer +84 4  
6266 1391  
aumi@aumi.com.vn  
www.aumi.com.vn

Repräsentanz Büro  
Weidmüller Pte. Ltd.  
Level 16 Saigon Tower  
Building  
29 Le Duan Street  
District 1  
Ho Chi Minh  
Telefonnummer +848 3520  
7717  
Faxnummer +848 3520  
7604  
info@weidmuller.com.sg

**ZA Südafrika**  
Phambili Interface  
PO Box 193  
1609 Johannesburg, Edenvale  
5 Bundo Road, Sebenza  
1610 Johannesburg  
Telefonnummer +27 (11)  
4521930  
Faxnummer  
info@weidmuller.co.za  
www.weidmuller.co.za

Repräsentanz Büro  
Weidmüller Interface GmbH  
& Co. KG  
210 Amarand  
Avenue, Pegasus Building  
181 Pretoria, waterkloof Glen  
ext 2 -  
Telefonnummer +27 12 003  
2906  
Faxnummer +27 (11)  
4526455  
Jacques.Vosloo@weidmueller.  
com  
www.weidmueller.com

**ZM Sambia**  
Bitte kontaktieren Sie  
Phambili Interface  
Südafrika

**ZW Simbabwe**  
Bitte kontaktieren Sie  
Phambili Interface  
Südafrika