

Contents

	Page
D-Sub adaptor	40.02
Han® Split Hood	40.04
Cable clamps for metric cable entries.	40.06
Cable clamps for Pg cable entries	40.08
Further Accessories	40.11
Coding for Hoods/Housings and inserts	40.12
PE-Multiple ground connection	40.13
Cable clamp fitting	40.14
Docking frame	40.15
Grip frame	40.16
Ground terminal	40.17
Screws	40.20
Locking levers	40.20
Gaskets, seals	40.22

Number of contacts

9-50



D-Sub adaptor for Han A® hood/housing

Identification	D-Sub size	Han A housing size	Part No.	Drawing	Dimensions in mm								
Plastic adaptor for 1 x D-Sub ¹⁾	9	10 A	09 20 000 9932										
	15	10 A	09 20 000 9928										
	25	10 A	09 20 000 9929	<table border="1"> <thead> <tr> <th>Size</th> <th>D-Sub</th> <th>c</th> </tr> </thead> <tbody> <tr> <td>10 A</td> <td>15</td> <td>33.3</td> </tr> <tr> <td>10 A</td> <td>25</td> <td>47</td> </tr> </tbody> </table>	Size	D-Sub	c	10 A	15	33.3	10 A	25	47
	Size	D-Sub	c										
10 A	15	33.3											
10 A	25	47											
50	16 A	09 20 000 9931											
Metal adaptor for 1 x D-Sub ¹⁾	25	10 A	09 20 000 9925										
	37	16 A	09 20 000 9925										

Delivery comprises:
 1 adaptor
 4 fixing screws for adaptor
 2 fixing screws for D-Sub connector

Delivery comprises:
 2 adaptor
 2 fixing screws for adaptor
 2 fixing screws for D-Sub connector

Accessories

40
02

¹⁾ only for Standard D-Sub, not for HD D-Sub

Stock items in bold type

Number of contacts

9-50



D-Sub adaptor for Han® B hood/housing

Identification	D-Sub size	Han B housing size	Part No.	Drawing	Dimensions in mm																														
Plastic adaptor for 1 x D-Sub¹⁾	9	6 B	09 30 000 9965	<p>Mounting in housing Character "A" visible</p> <p>Mounting in hood Character "T" visible</p>	<table border="1"> <thead> <tr> <th>Size</th> <th>D-Sub</th> <th>a</th> <th>b</th> <th>c</th> </tr> </thead> <tbody> <tr> <td>6 B</td> <td>9</td> <td>44</td> <td>51.5</td> <td>25</td> </tr> <tr> <td>6 B</td> <td>15</td> <td>44</td> <td>51.5</td> <td>33.3</td> </tr> <tr> <td>10 B</td> <td>25</td> <td>57</td> <td>64.5</td> <td>47</td> </tr> <tr> <td>16 B</td> <td>37</td> <td>77.5</td> <td>85</td> <td>63.5</td> </tr> <tr> <td>16 B</td> <td>50</td> <td>77.5</td> <td>85</td> <td>61.1</td> </tr> </tbody> </table>	Size	D-Sub	a	b	c	6 B	9	44	51.5	25	6 B	15	44	51.5	33.3	10 B	25	57	64.5	47	16 B	37	77.5	85	63.5	16 B	50	77.5	85	61.1
	Size	D-Sub	a			b	c																												
	6 B	9	44			51.5	25																												
	6 B	15	44			51.5	33.3																												
	10 B	25	57			64.5	47																												
16 B	37	77.5	85	63.5																															
16 B	50	77.5	85	61.1																															
15	6 B	09 30 000 9966																																	
25	10 B	09 30 000 9967																																	
37	16 B	09 30 000 9968																																	
50	16 B	09 30 000 9969																																	
Delivery comprises: 1 adaptor 4 fixing screws for adaptor 2 fixing screws for D-Sub connector																																			
Plastic adaptor for 2 x D-Sub¹⁾	2 x 9	6 B	09 30 000 9970	<p>Mounting in housing Character "A" visible</p> <p>Mounting in hood Character "T" visible</p>	<table border="1"> <thead> <tr> <th>Size</th> <th>D-Sub</th> <th>a</th> <th>b</th> <th>c</th> </tr> </thead> <tbody> <tr> <td>6 B</td> <td>9</td> <td>44</td> <td>51.5</td> <td>25</td> </tr> <tr> <td>6 B</td> <td>15</td> <td>44</td> <td>51.5</td> <td>33.3</td> </tr> <tr> <td>10 B</td> <td>25</td> <td>57</td> <td>64.5</td> <td>47</td> </tr> <tr> <td>16 B</td> <td>37</td> <td>77.5</td> <td>85</td> <td>63.5</td> </tr> <tr> <td>16 B</td> <td>50</td> <td>77.5</td> <td>85</td> <td>61.1</td> </tr> </tbody> </table>	Size	D-Sub	a	b	c	6 B	9	44	51.5	25	6 B	15	44	51.5	33.3	10 B	25	57	64.5	47	16 B	37	77.5	85	63.5	16 B	50	77.5	85	61.1
	Size	D-Sub	a			b	c																												
	6 B	9	44			51.5	25																												
	6 B	15	44			51.5	33.3																												
	10 B	25	57			64.5	47																												
16 B	37	77.5	85	63.5																															
16 B	50	77.5	85	61.1																															
2 x 15	6 B	09 30 000 9971																																	
2 x 25	10 B	09 30 000 9972																																	
2 x 37	16 B	09 30 000 9973																																	
2 x 50	16 B	09 30 000 9974																																	
Delivery comprises: 1 adaptor 4 fixing screws for adaptor 4 fixing screws for D-Sub connector																																			

Accessories

¹⁾ only for Standard D-Sub, not for HD D-Sub



Features

- ❑ Compatible with Han® B housings, bulkhead mounting, with 2 levers, standard panel cut out
- ❑ Allows the entry of pre-assembled cables into a switch cabinet
- ❑ IP 54 due to continuous contoured sealing
- ❑ Easy handling
- ❑ No special tools required for assembly
- ❑ Standard screw driver (5 x 1 mm) necessary to open split hood
- ❑ Up to 4 cable entries (3 – 16 mm diameter)
- ❑ High cable density
- ❑ From 10 mm Ø upwards cable tie is available for better strain relief
- ❑ Use of identification strips is possible
- ❑ Little wiring work and high degree of flexibility
- ❑ Manufacturer's guarantee of pre-assembled cables remains valid

Technical characteristics

Split hood

Material	Polycarbonate
Flammability acc. to UL 94	V 0
Limiting temperatures	– 40 °C / + 125 °C
Cable entries	3, 4
Degree of protection in locked position with correct grommet	IP 54 ¹⁾
Max. cable diameter	3 – 16 mm
Locking cycles of bulkhead mounted housings	≥ 50
Locking cycles of split hood halves	≥ 10

Cable entry glands

Material	Thermoplastic rubber, UL listed
Limiting temperatures	– 40 °C / + 125 °C
Colour	black

Pack contents

2 split hood halves

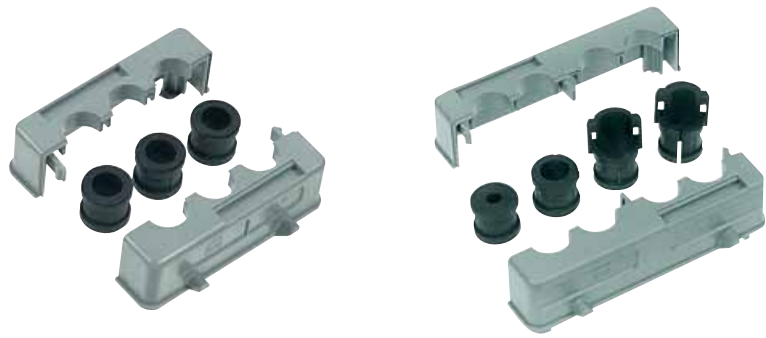

with up to 4 cable entries

Identification	Size	Part No.	Drawing	Dimensions in mm												
Split hood for 3 cable entries for 4 cable entries	16 B 24 B	09 30 016 0408 09 30 024 0408														
Housings bulkhead mounting 	16 B 24 B	09 30 016 0301 09 30 024 0301		<table border="1"> <thead> <tr> <th>Size</th> <th>a</th> <th>b</th> <th>Panel cut out</th> </tr> </thead> <tbody> <tr> <td>16 B</td> <td>103</td> <td>113</td> <td>82 x 35</td> </tr> <tr> <td>24 B</td> <td>130</td> <td>140</td> <td>108 x 35</td> </tr> </tbody> </table>	Size	a	b	Panel cut out	16 B	103	113	82 x 35	24 B	130	140	108 x 35
Size	a	b	Panel cut out													
16 B	103	113	82 x 35													
24 B	130	140	108 x 35													
Identification	Suitable cable Ø	Part No.	Drawing	Dimensions in mm												
Cable entry gland order separately from Ø 10 mm upwards additional strain relief can be provided by cable ties (max. width 8 mm) for ASI cable	3- 4 4- 5 5- 6 6- 7 7- 8 8- 9 9-10 10-11 11-12 12-13 13-14 14-15 15-16 -	09 00 000 5351 09 00 000 5352 09 00 000 5353 09 00 000 5354 09 00 000 5355 09 00 000 5356 09 00 000 5357 09 00 000 5358 09 00 000 5359 09 00 000 5360 09 00 000 5361 09 00 000 5362 09 00 000 5363 09 00 000 5364														
Blind grommet	-	09 00 000 5350														
Identification strips order separately 9 mm wide 20 mm long 20 pieces in one block	-	09 33 000 9982														

Accessories

Identification

Part No.

Drawing

Dimensions in mm

Cable gland
for metric cable entries (IP 68)

Metal



19 00 000 5080
19 00 000 5082
19 00 000 5084
19 00 000 5090
19 00 000 5092
19 00 000 5094
19 00 000 5096
19 00 000 5097
19 00 000 5098

thread M	cable diameter D	SW	E	Nm
20	5 - 9 mm	22	24.4	10
20	6 - 12 mm	22	24.4	10
20	10 - 14 mm	24	26.5	10
25	9 - 16 mm	30	33.5	15
25	13 - 18 mm	30	33.5	15
32	13 - 20 mm	40	44	15
32	18 - 25 mm	40	44	15
40	20 - 26 mm	50	55	20
40	22 - 32 mm	50	55	20

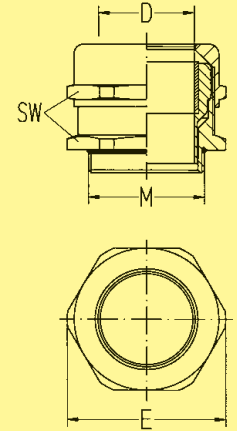

Thermoplastic, white











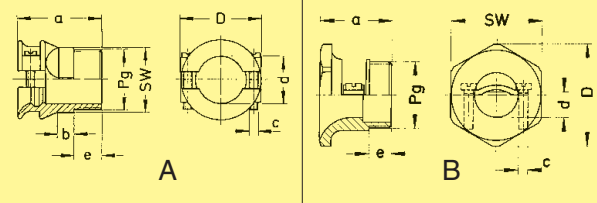
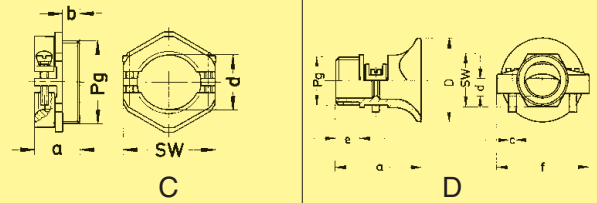

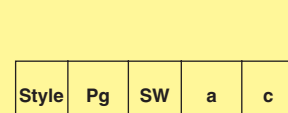
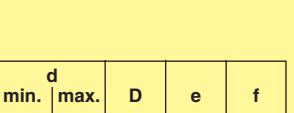

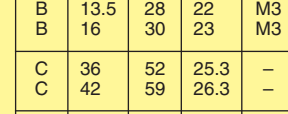
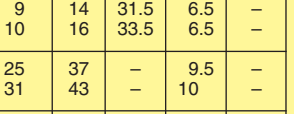

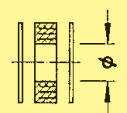
19 00 000 5180
19 00 000 5182
19 00 000 5184
19 00 000 5190
19 00 000 5192
19 00 000 5194
19 00 000 5196
19 00 000 5197
19 00 000 5198

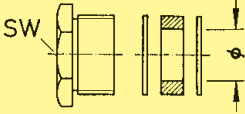

20	5 - 9 mm	24	26.4	8
20	6 - 12 mm	24	26.4	8
20	10 - 14 mm	27	29.8	10
25	9 - 16 mm	33	36.5	12
25	13 - 18 mm	33	36.5	12
32	13 - 20 mm	42	46.8	15
32	18 - 25 mm	42	46.8	15
40	20 - 26 mm	53	58.8	15
40	22 - 32 mm	53	58.8	15

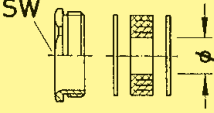
Identification	Part No.	Drawing	Dimensions in mm																																																																																	
Blanking piece for metric cable entries Metal	19 00 000 5070 19 00 000 5071 19 00 000 5072 19 00 000 5073	<table border="1"> <thead> <tr> <th>thread M</th> <th>SW</th> <th>E</th> </tr> </thead> <tbody> <tr> <td>20</td> <td>22</td> <td>25.4</td> </tr> <tr> <td>25</td> <td>28</td> <td>32.3</td> </tr> <tr> <td>32</td> <td>35</td> <td>40.4</td> </tr> <tr> <td>40</td> <td>44</td> <td>50.8</td> </tr> </tbody> </table>	thread M	SW	E	20	22	25.4	25	28	32.3	32	35	40.4	40	44	50.8																																																																			
		thread M	SW	E																																																																																
20	22	25.4																																																																																		
25	28	32.3																																																																																		
32	35	40.4																																																																																		
40	44	50.8																																																																																		
Reducers for metric cable entries Metal	19 00 000 5060 19 00 000 5067 19 00 000 5068	<table border="1"> <thead> <tr> <th colspan="2">thread</th> </tr> <tr> <th>D</th> <th>M</th> </tr> </thead> <tbody> <tr> <td>16</td> <td>20</td> </tr> <tr> <td>20</td> <td>32</td> </tr> <tr> <td>25</td> <td>32</td> </tr> </tbody> </table>	thread		D	M	16	20	20	32	25	32																																																																								
thread																																																																																				
D	M																																																																																			
16	20																																																																																			
20	32																																																																																			
25	32																																																																																			
Adapter Han® 3 A for motor connection	19 20 000 9962	<table border="1"> <thead> <tr> <th>thread M</th> </tr> </thead> <tbody> <tr> <td>20</td> </tr> </tbody> </table>	thread M	20																																																																																
thread M																																																																																				
20																																																																																				
EMC clamp for metric cable entries (IP 68)	19 62 000 5080 19 62 000 5081 19 62 000 5082 19 62 000 5084 19 62 000 5090 19 62 000 5092 19 62 000 5094 19 62 000 5096 19 62 000 5097 19 62 000 5098	<table border="1"> <thead> <tr> <th rowspan="2">thread M</th> <th colspan="2">cable-Ø D</th> <th colspan="2">shield-Ø B</th> <th rowspan="2">SW</th> <th rowspan="2">E</th> </tr> <tr> <th>min.</th> <th>max.</th> <th>min.</th> <th>max.</th> </tr> </thead> <tbody> <tr> <td>20</td> <td>6,5</td> <td>9,5</td> <td>3,5</td> <td>8,5</td> <td>22</td> <td>24,4</td> </tr> <tr> <td>20</td> <td>4,0</td> <td>6,5</td> <td>2,5</td> <td>6,5</td> <td>22</td> <td>24,4</td> </tr> <tr> <td>20</td> <td>7</td> <td>10,5</td> <td>6,5</td> <td>10,5</td> <td>22</td> <td>24,4</td> </tr> <tr> <td>20</td> <td>9</td> <td>13</td> <td>6,5</td> <td>10,5</td> <td>22</td> <td>24,4</td> </tr> <tr> <td>25</td> <td>6,5</td> <td>9,5</td> <td>3</td> <td>8</td> <td>28</td> <td>31,2</td> </tr> <tr> <td>25</td> <td>9</td> <td>13</td> <td>4,8</td> <td>8</td> <td>28</td> <td>31,2</td> </tr> <tr> <td>32</td> <td>11,5</td> <td>15,5</td> <td>8</td> <td>13,5</td> <td>35</td> <td>38,5</td> </tr> <tr> <td>32</td> <td>14</td> <td>18</td> <td>9</td> <td>14,5</td> <td>35</td> <td>38,5</td> </tr> <tr> <td>40</td> <td>17</td> <td>20,5</td> <td>15</td> <td>20</td> <td>43</td> <td>47,3</td> </tr> <tr> <td>40</td> <td>20</td> <td>25</td> <td>15</td> <td>20</td> <td>43</td> <td>47,3</td> </tr> </tbody> </table>	thread M	cable-Ø D		shield-Ø B		SW	E	min.	max.	min.	max.	20	6,5	9,5	3,5	8,5	22	24,4	20	4,0	6,5	2,5	6,5	22	24,4	20	7	10,5	6,5	10,5	22	24,4	20	9	13	6,5	10,5	22	24,4	25	6,5	9,5	3	8	28	31,2	25	9	13	4,8	8	28	31,2	32	11,5	15,5	8	13,5	35	38,5	32	14	18	9	14,5	35	38,5	40	17	20,5	15	20	43	47,3	40	20	25	15	20	43	47,3	
		thread M		cable-Ø D		shield-Ø B				SW	E																																																																									
min.	max.		min.	max.																																																																																
20	6,5	9,5	3,5	8,5	22	24,4																																																																														
20	4,0	6,5	2,5	6,5	22	24,4																																																																														
20	7	10,5	6,5	10,5	22	24,4																																																																														
20	9	13	6,5	10,5	22	24,4																																																																														
25	6,5	9,5	3	8	28	31,2																																																																														
25	9	13	4,8	8	28	31,2																																																																														
32	11,5	15,5	8	13,5	35	38,5																																																																														
32	14	18	9	14,5	35	38,5																																																																														
40	17	20,5	15	20	43	47,3																																																																														
40	20	25	15	20	43	47,3																																																																														

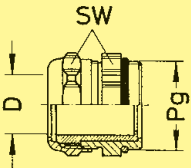

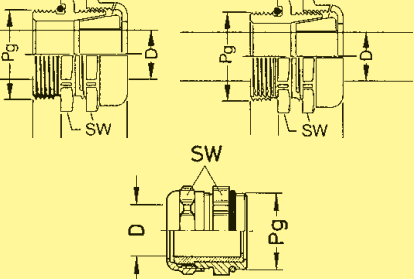

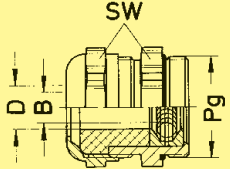

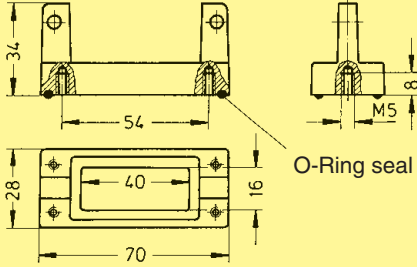
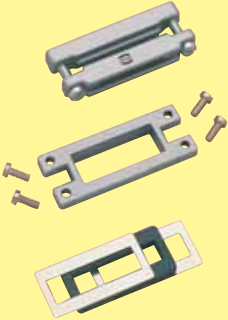
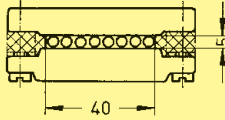
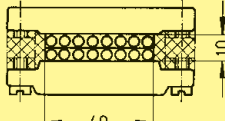
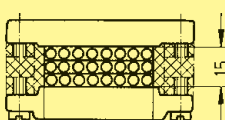

Accessories

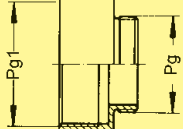
Identification	Part No.	Pg	Drawing	Dimensions in mm																					
<p>Special cable clamp metal, with bell-mouth cable fitting and strain relief</p> <p>for Standard Hoods/Housings</p>  <p>Style A Style B Style B Style A Style A</p>	<p>09 00 000 5101 09 00 000 5102 09 00 000 5103 09 00 000 5104 09 00 000 5106</p>	<p>11 13.5 16 21 29</p>																							
<p>Special cable clamp brass, with strain relief</p>  <p>Style C Style C</p>	<p>09 00 000 5196 09 00 000 5197</p>	<p>36 42</p>																							
<p>Special cable clamp thermoplastic, with bell-mouth cable fitting and strain relief</p>  <p>Style D Style D Style D Style D Style D Style D</p>	<p>09 00 000 5165 09 00 000 5166 09 00 000 5167 09 00 000 5168 09 00 000 5169 09 00 000 5170</p>	<p>11 13.5 16 21 29 36</p>																							
<p>Multiple seal</p> 	<p>09 00 000 5027 09 00 000 5028 09 00 000 5029 09 00 000 5030 09 00 000 5031 09 00 000 5032</p>	<p>11 13.5 16 21 29 36</p>	<table border="1"> <thead> <tr> <th rowspan="2">cable ϕ</th> <th colspan="2">min. max.</th> </tr> </thead> <tbody> <tr> <td>6,5</td> <td>12</td> <td></td> </tr> <tr> <td>6,5</td> <td>13,5</td> <td></td> </tr> <tr> <td>6,5</td> <td>16</td> <td></td> </tr> <tr> <td>9</td> <td>20</td> <td></td> </tr> <tr> <td>17</td> <td>28</td> <td></td> </tr> <tr> <td>23</td> <td>34</td> <td></td> </tr> </tbody> </table> 	cable ϕ	min. max.		6,5	12		6,5	13,5		6,5	16		9	20		17	28		23	34		<p>Accessories</p>
cable ϕ	min. max.																								
	6,5	12																							
6,5	13,5																								
6,5	16																								
9	20																								
17	28																								
23	34																								

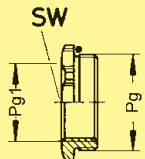
Identification	Part No.	Pg	Drawing	Dimensions in mm																								
Cable seal thermoplastic (IP 65) with normal seal 	grey 09 00 000 5164	11	SW																									
	black 09 00 000 5185	11	<table border="1"> <thead> <tr> <th>SW</th> <th>min.</th> <th>max.</th> </tr> </thead> <tbody> <tr> <td>19</td> <td>10</td> <td>12</td> </tr> <tr> <td>19</td> <td>10</td> <td>12</td> </tr> </tbody> </table>		SW	min.	max.	19	10	12	19	10	12															
SW	min.	max.																										
19	10	12																										
19	10	12																										
Cable seal metal (IP 65) with multiple seal 	09 00 000 5013	11	SW																									
	09 00 000 5014	13.5	<table border="1"> <thead> <tr> <th>SW</th> <th>min.</th> <th>max.</th> </tr> </thead> <tbody> <tr> <td>18</td> <td>6.5</td> <td>12</td> </tr> <tr> <td>20</td> <td>6.5</td> <td>13.5</td> </tr> <tr> <td>22</td> <td>6.5</td> <td>16</td> </tr> <tr> <td>28</td> <td>9</td> <td>20</td> </tr> <tr> <td>37</td> <td>17</td> <td>28</td> </tr> <tr> <td>47</td> <td>23</td> <td>34</td> </tr> <tr> <td>54</td> <td>29</td> <td>40</td> </tr> </tbody> </table>		SW	min.	max.	18	6.5	12	20	6.5	13.5	22	6.5	16	28	9	20	37	17	28	47	23	34	54	29	40
	SW	min.	max.																									
	18	6.5	12																									
	20	6.5	13.5																									
	22	6.5	16																									
	28	9	20																									
	37	17	28																									
	47	23	34																									
	54	29	40																									
09 00 000 5015	16																											
09 00 000 5016	21																											
09 00 000 5017	29																											
09 00 000 5018	36																											
09 00 000 5019	42																											
Universal cable gland Pg (IP 68) for Pg cable entry 	09 00 000 5080	11	Colour																									
	09 00 000 5081	11	grey																									
	09 00 000 5082	11	black																									
	09 00 000 5083	13.5	green																									
	09 00 000 5084	13.5	black																									
	09 00 000 5085	13.5	green																									
	09 00 000 5086	16	red																									
	09 00 000 5087	16	black																									
	09 00 000 5088	16	green																									
	09 00 000 5089	16	red																									
	09 00 000 5090	21	white																									
	09 00 000 5091	21	green																									
	09 00 000 5092	21	red																									
	09 00 000 5093	21	white																									
	09 00 000 5094	29	blue																									
	09 00 000 5095	29	brown																									
	09 00 000 5096	29	orange																									
	09 00 000 5097	29	light yellow																									
09 00 000 5098	36	light blue																										
09 00 000 5099	36	pink																										
Cable gland Metal Thermoplastic Thermoplastic 	09 00 000 5183	11	SW																									
	09 00 000 5182	11	<table border="1"> <thead> <tr> <th>SW</th> <th>min.</th> <th>max.</th> </tr> </thead> <tbody> <tr> <td>21</td> <td>7</td> <td>12</td> </tr> <tr> <td>24</td> <td>7</td> <td>12</td> </tr> </tbody> </table>		SW	min.	max.	21	7	12	24	7	12															
	SW	min.	max.																									
21	7	12																										
24	7	12																										
09 00 000 5153	21	<table border="1"> <thead> <tr> <th>SW</th> <th>min.</th> <th>max.</th> </tr> </thead> <tbody> <tr> <td>33</td> <td>13</td> <td>18</td> </tr> </tbody> </table>	SW	min.	max.	33	13	18																				
SW	min.	max.																										
33	13	18																										

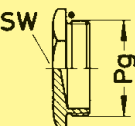

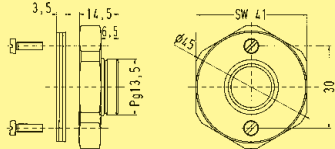
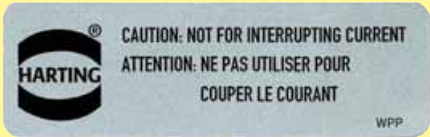

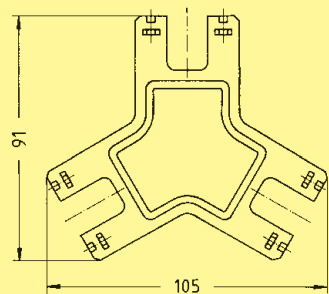
Identification	Part No.	Pg	Drawing	Dimensions in mm																																																																																																
EMC clamp (IP 68) 	09 62 000 5023	11	<table border="1"> <thead> <tr> <th rowspan="2">SW</th> <th colspan="2">Shield Ø B</th> <th colspan="2">cable Ø D</th> </tr> <tr> <th>min.</th> <th>max.</th> <th>min.</th> <th>max.</th> </tr> </thead> <tbody> <tr> <td>20</td> <td>2.5</td> <td>6.5</td> <td>4</td> <td>6.5</td> </tr> <tr> <td>20</td> <td>3.5</td> <td>8.5</td> <td>6.5</td> <td>8.5</td> </tr> <tr> <td>22</td> <td>6.5</td> <td>10.5</td> <td>8</td> <td>10.5</td> </tr> <tr> <td>09 62 000 5003</td> <td>13.5</td> <td>22</td> <td>2.5</td> <td>6.5</td> <td>6.5</td> <td>9.5</td> </tr> <tr> <td>09 62 000 5004</td> <td>13.5</td> <td>22</td> <td>6.5</td> <td>10.5</td> <td>9</td> <td>13</td> </tr> <tr> <td>09 62 000 5005</td> <td>16</td> <td>24</td> <td>3.5</td> <td>8</td> <td>6.5</td> <td>9.5</td> </tr> <tr> <td>09 62 000 5006</td> <td>16</td> <td>24</td> <td>4.5</td> <td>8</td> <td>9</td> <td>13</td> </tr> <tr> <td>09 62 000 5007</td> <td>21</td> <td>30</td> <td>9.5</td> <td>13.5</td> <td>11.5</td> <td>15.5</td> </tr> <tr> <td>09 62 000 5008</td> <td>21</td> <td>30</td> <td>10.5</td> <td>14.5</td> <td>14</td> <td>18</td> </tr> <tr> <td>09 62 000 5009</td> <td>29</td> <td>40</td> <td>15</td> <td>20</td> <td>17</td> <td>20.5</td> </tr> <tr> <td>09 62 000 5010</td> <td>29</td> <td>40</td> <td>15</td> <td>20</td> <td>20</td> <td>25</td> </tr> <tr> <td>09 62 000 5011</td> <td>36</td> <td>50</td> <td>18</td> <td>25.5</td> <td>24</td> <td>28</td> </tr> <tr> <td>09 62 000 5012</td> <td>36</td> <td>50</td> <td>24</td> <td>31</td> <td>27</td> <td>32</td> </tr> </tbody> </table> 	SW	Shield Ø B		cable Ø D		min.	max.	min.	max.	20	2.5	6.5	4	6.5	20	3.5	8.5	6.5	8.5	22	6.5	10.5	8	10.5	09 62 000 5003	13.5	22	2.5	6.5	6.5	9.5	09 62 000 5004	13.5	22	6.5	10.5	9	13	09 62 000 5005	16	24	3.5	8	6.5	9.5	09 62 000 5006	16	24	4.5	8	9	13	09 62 000 5007	21	30	9.5	13.5	11.5	15.5	09 62 000 5008	21	30	10.5	14.5	14	18	09 62 000 5009	29	40	15	20	17	20.5	09 62 000 5010	29	40	15	20	20	25	09 62 000 5011	36	50	18	25.5	24	28	09 62 000 5012	36	50	24	31	27	32			
	SW	Shield Ø B			cable Ø D																																																																																															
		min.		max.	min.	max.																																																																																														
	20	2.5		6.5	4	6.5																																																																																														
	20	3.5		8.5	6.5	8.5																																																																																														
	22	6.5		10.5	8	10.5																																																																																														
	09 62 000 5003	13.5		22	2.5	6.5	6.5	9.5																																																																																												
	09 62 000 5004	13.5		22	6.5	10.5	9	13																																																																																												
	09 62 000 5005	16		24	3.5	8	6.5	9.5																																																																																												
	09 62 000 5006	16		24	4.5	8	9	13																																																																																												
	09 62 000 5007	21		30	9.5	13.5	11.5	15.5																																																																																												
	09 62 000 5008	21		30	10.5	14.5	14	18																																																																																												
09 62 000 5009	29	40	15	20	17	20.5																																																																																														
09 62 000 5010	29	40	15	20	20	25																																																																																														
09 62 000 5011	36	50	18	25.5	24	28																																																																																														
09 62 000 5012	36	50	24	31	27	32																																																																																														
Bracket for flat cable for separate mounting 	09 00 000 5325			O-Ring seal																																																																																																
Set of seals with strain relief clamp 	for 1 flat cable 09 00 000 5315	—																																																																																																		
	for 2 flat cables 09 00 000 5316	—																																																																																																		
	for 3 flat cables 09 00 000 5317	—																																																																																																		

Stock items in bold type

Identification	Part No.	Pg	Drawing	Dimensions in mm
Increasers metal 	09 00 000 5050	11	Pg1	
	09 00 000 5051	13.5	13.5	
	09 00 000 5052	16	16	
	09 00 000 5053	21	21	
	09 00 000 5054	29	29	
	09 00 000 5055	36	36	
	09 00 000 5056	42	42	
Reducers metal 	09 00 000 5060	11	Pg1 SW	
	09 00 000 5061	11	7 20	
	09 00 000 5062	13.5	9 20	
	09 00 000 5063	13.5	9 22	
	09 00 000 5064	16	11 22	
	09 00 000 5065	21	13.5 24	
	09 00 000 5066	21	13.5 30	
	09 00 000 5067	29	16 30	
	09 00 000 5068	29	16 40	
			21	
Blanking piece metal 	09 00 000 5070	11	SW	
	09 00 000 5071	13.5	20	
	09 00 000 5072	16	22	
	09 00 000 5073	21	24	
	09 00 000 5074	29	30	
	09 00 000 5075	36	40	
Adapter Han® 3 A for motor connection 	09 20 000 9962	13.5		
Label according to CSA-approval 	09 30 000 9958		When supplying connectors for use at more than 30 V subject to CSA-approval we recommend that the label is fixed in close proximity to the installed connectors. Dimensions: 56 x 18 mm Part No. comprises 50 labels per sheet	
Assembly plates for custom test adapters Mounting example: 	09 38 000 9901			

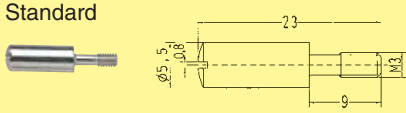
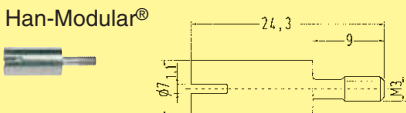
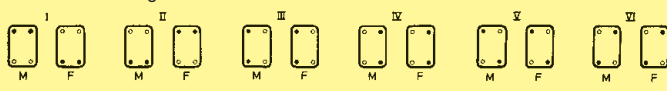
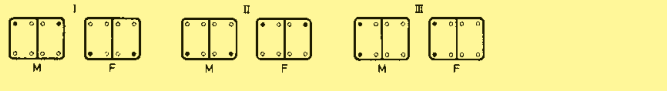
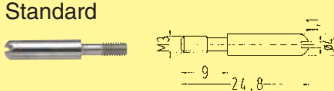
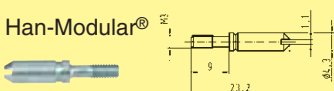
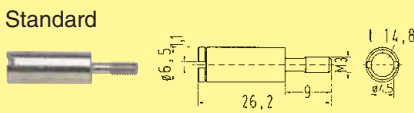
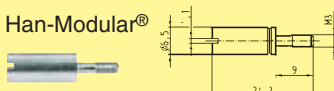
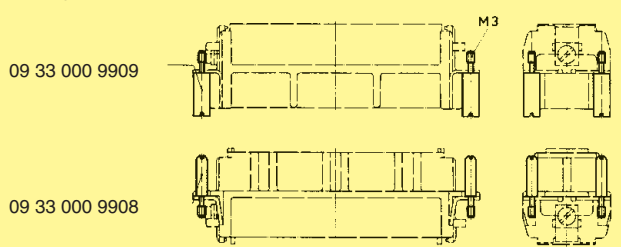
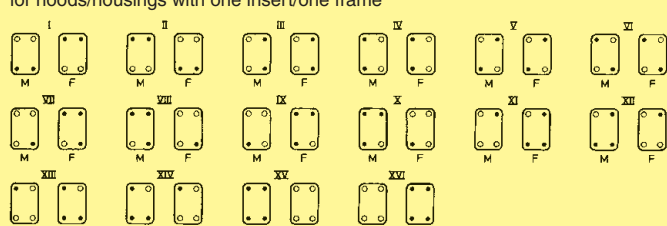
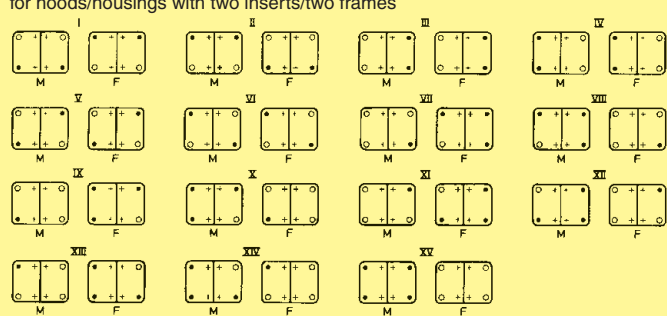
Accessories

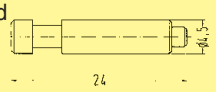
Delivery comprises – 2 assembly plates
– 12 nuts for insertion

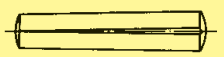
Identification	Part No.	Drawing	Dimensions in mm
<p>Coding system with code pins</p> <p>Standard</p>  <p>Han-Modular®</p> 	<p>09 30 000 9901¹⁾</p> <p>09 14 000 9901¹⁾</p>	<p>for hoods/housings with one insert/one frame</p>  <p>for hoods/housings with two inserts/two frames</p>  <p>● Code pins ○ Normal mounting screw</p> <p>M – Male connector F – Female connector</p>	
<p>Coding system with guide pins and bushes</p> <p>Guide pin</p> <p>Standard</p>  <p>Han-Modular®</p>  <p>Bush</p> <p>Standard</p>  <p>Han-Modular®</p> 	<p>09 33 000 9908¹⁾</p> <p>09 14 000 9908¹⁾</p> <p>09 33 000 9909¹⁾</p> <p>09 14 000 9909¹⁾</p>	<p>This system is used to guard against angled coupling and decoupling of the connector. The maximum permitted angle according to DIN EN 175301-801 is $\pm 5^\circ$ (longitudinally).</p>  <p>for hoods/housings with one insert/one frame</p>  <p>for hoods/housings with two inserts/two frames</p>  <p>● Guide pin ○ Bush + Normal mounting screw</p> <p>M – Male connector F – Female connector</p>	
<p>Coding Pin for Han E®, Han® EE Han® Q 5/0, Han® Q 8/0</p> 	<p>09 33 000 9954</p>		<p>Use of the coding pin prevents incorrect mating to other connectors of the same type.</p> <p>The male pin should be omitted from the opposing cavity in the male insert.</p> 
<p>Coding system with loss of contact for Han D®, Han DD®</p> 	<p>09 33 000 9915</p>	<p>Use of the coding pin prevents incorrect mating to other connectors of the same type.</p> <p>The male pin should be omitted from the opposing cavity in the male insert.</p> 	

Accessories

40
12

¹⁾ Order 4 pieces for one connector

Stock items in bold type

3 x

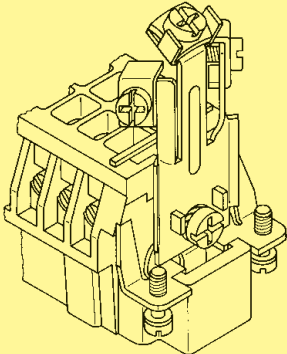

Multiple ground connection

Identification	Part No.	Drawing	Dimensions in mm
PE-Multiple ground connection	09 33 000 9992		

Features

- 3 PE-terminations
- Screws with ± head
- Self lifting washer
- Suitable for use with all inserts of the Han® 6 B to 24 B size (except Han® ESS-inserts)
- Suitable in hood high construction

Technical characteristics

Termination points	3
Termination wire gauge	0.5–2.5 mm ² AWG 20-14
Material	copper alloy
Surface	Ni
Contact resistance	≤ 3 m Ω

Application

The PE-multiple ground connection may be used to terminate three PE-wires on one connector.





Each PE-wire can be terminated and removed separately.

(acc. VDE 0113 DIN EN 60204 Pt. 14.1.1).

Pack contents

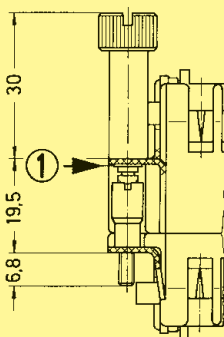
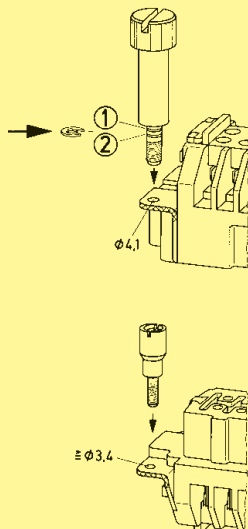
- Delivery comprises
- Multiple ground connection
 - Fixing screw M4 with washer

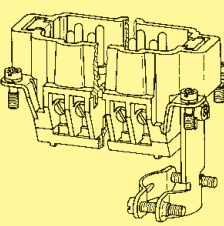
Security accessories

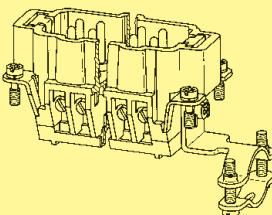
Identification	Part No.	Drawing	Dimensions in mm
<p>Screw pin¹⁾</p> 	09 33 000 9910	<p>When using inserts without hoods or housings and requiring a locking facility this system is suitable for all rectangular connectors of the Han® B series.</p> <p>For each connector we recommend two screw pins and two bushes as shown which are fitted diagonally to the inserts instead of the ordinary fixing screws. Holes for fixing to be drilled as shown.</p> <p>Mounting example</p> 	
<p>Bush¹⁾</p> 	09 33 000 9912		
<p>¹⁾ order 2 pieces for one connector</p>			
<p>Straight cable clamp fitting</p> 	09 00 000 5340		<p>Clamping range of strain relief clamp: 9 - 19 mm</p>
<p>Angled cable clamp fitting</p> 	09 00 000 5339		

Features

When using inserts without hoods or housings and requiring a strain relief this system is suitable for all rectangular connectors of series Han DD®, Han® 40-64 D, Han E® / Han® ES, Han® HsB, Han Hv E® / Han® Hv ES, Han® EE, Han® K 8/24. Fitted at the opposite end to the PE-termination.

Pack contents

Delivery comprises

- Cable clamp fitting with 2 screws M3
- Fixing screw M4 with washer

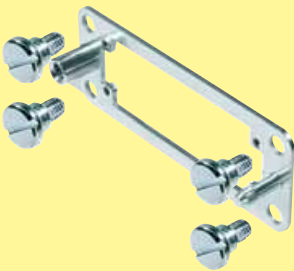
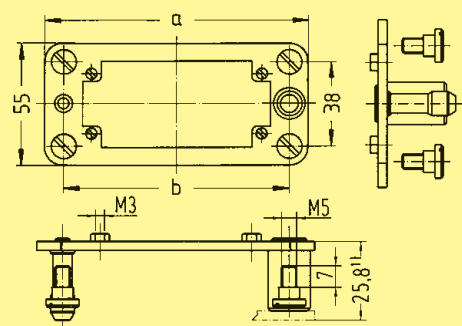
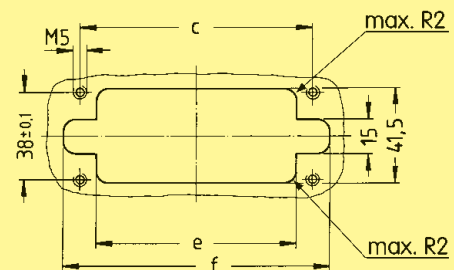

Identification	Size	Part No.	Drawing	Dimensions in mm																														
Han® Docking frame 	6 B	09 30 006 1701	 <p>1) Distances for electrical and FOC contacts max. 27 mm, for pneumatic contacts max. 26.5 mm</p> <p>Assembly cut out</p> 																															
	10 B	09 30 010 1701																																
	16 B	09 30 016 1701																																
	24 B	09 30 024 1701																																
			<table border="1"> <thead> <tr> <th>Size</th> <th>a</th> <th>b</th> <th>c</th> <th>e</th> <th>f</th> </tr> </thead> <tbody> <tr> <td>6 B</td> <td>86</td> <td>69</td> <td>69</td> <td>54.5</td> <td>84</td> </tr> <tr> <td>10 B</td> <td>99</td> <td>82</td> <td>82</td> <td>67.5</td> <td>97</td> </tr> <tr> <td>16 B</td> <td>119.5</td> <td>102.5</td> <td>102.5</td> <td>88</td> <td>117.5</td> </tr> <tr> <td>24 B</td> <td>146</td> <td>129</td> <td>129</td> <td>114.5</td> <td>144</td> </tr> </tbody> </table>	Size	a	b	c	e	f	6 B	86	69	69	54.5	84	10 B	99	82	82	67.5	97	16 B	119.5	102.5	102.5	88	117.5	24 B	146	129	129	114.5	144	
Size	a	b	c	e	f																													
6 B	86	69	69	54.5	84																													
10 B	99	82	82	67.5	97																													
16 B	119.5	102.5	102.5	88	117.5																													
24 B	146	129	129	114.5	144																													

Features

- ❑ Suitable for all inserts of the series Han® B, Han E®, Han® ES, Han DD®, Han-Com® and Han-Modular®
- ❑ Ideal for applications in the field of transportation, as well as in the printing industry
- ❑ Due to the floating system of the docking frame the PE connection of the mounting base has to be installed separately
- ❑ Inserts are protected against mechanical damage

Technical characteristics

Material	
- Docking frame	Stainless Steel
- Fixing screws	Steel, zinc plated
Pull-in-range	
- x-axis	± 1.5 mm
- y-axis	± 1.5 mm
Mechanical working life	
- Mating cycles	≥ 500

Pack contents

- Delivery comprises
- 1 frame
 - 4 cheese head shoulder screws to fix the docking frame

Accessories

Identification	Size	Part No.	Drawing	Dimensions in mm															
Grip frame	24 B	09 00 024 5601																	
Grip frame with screw adaptor and screw	24 B	09 00 024 5611*																	
* to use in connection with 09 00 000 5602																			
Screw adaptor bulkhead mounting		09 00 000 5602*																	
* to use in connection with 09 00 024 5611																			
			<table border="1"> <thead> <tr> <th>Size</th> <th>Han 6 B</th> <th>Han 10 B</th> <th>Han 16 B</th> <th>Han 24 B</th> </tr> </thead> <tbody> <tr> <td>a</td> <td>44</td> <td>57</td> <td>77.5</td> <td>104</td> </tr> <tr> <td>b</td> <td>35</td> <td>48</td> <td>68.5</td> <td>95</td> </tr> </tbody> </table>	Size	Han 6 B	Han 10 B	Han 16 B	Han 24 B	a	44	57	77.5	104	b	35	48	68.5	95	
Size	Han 6 B	Han 10 B	Han 16 B	Han 24 B															
a	44	57	77.5	104															
b	35	48	68.5	95															
Screw adaptor bulkhead mounting		09 00 000 5603																	
			<table border="1"> <thead> <tr> <th>Size</th> <th>Han 6 B</th> <th>Han 10 B</th> <th>Han 16 B</th> <th>Han 24 B</th> </tr> </thead> <tbody> <tr> <td>a</td> <td>52</td> <td>65</td> <td>85.5</td> <td>112</td> </tr> <tr> <td>b</td> <td>65</td> <td>78</td> <td>98.5</td> <td>125</td> </tr> </tbody> </table>	Size	Han 6 B	Han 10 B	Han 16 B	Han 24 B	a	52	65	85.5	112	b	65	78	98.5	125	
Size	Han 6 B	Han 10 B	Han 16 B	Han 24 B															
a	52	65	85.5	112															
b	65	78	98.5	125															

Features

- Grip frame suitable for Han® 64 D, 108 DD
Han® 24 E, ES, ESS
Han® 46 EE
- Multiple shield connections via grip frame
- Cable can be fixed with clamps or cable tie

Technical characteristics

Grip frame	
- Surface	8 µm Zn
Adaptor	
- Surface	Die cast zinc alloy 5 µ Ni over 8 µ Cu

Application

The grip frame can be used for termination of several shielded cables to be fixed on one connector.

Stock items in bold type

Identification	Size	Part No.	Drawing	Dimensions in mm
Ground terminal for Han E®, Han® EE and Han DD® in housings and hoods, high construction, and Han-Snap®	6 B	09 00 000 5206		
	10 B	09 00 000 5207		
	16 B	09 00 000 5208		
	24 B	09 00 000 5210		
	24 B	09 00 000 5280		

Technical characteristics

Material: steel, zinc plated

Pack contents

Ground terminal frame with M 4 screws
for fixing at insert

Accessories

Identification	Part No.	Drawing	Dimensions in mm
Clamp for ground terminal	09 00 000 5341	cable Ø	
	09 00 000 5342	10 mm	

Stock items in bold type

Identification	Size	Part No.	Drawing	Dimensions in mm
Ground terminal for Han-Modular® in housings bulk- head mounting	6 B	09 00 000 5256		
	10 B	09 00 000 5257		
	16 B	09 00 000 5258		
	24 B	09 00 000 5211		
Accessories Ground terminal for Han-Quintax® in housings bulk- head mounting	24 B	09 00 000 5235		
	24 B	09 00 000 5298		

Stock items in bold type

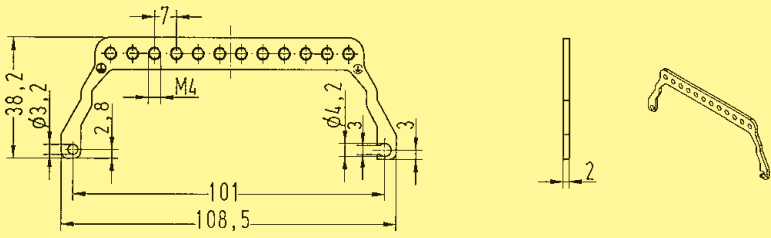
Identification	Size	Part No.	Drawing	Dimensions in mm
PE terminal for Han-Modular® in housings and hoods, high construction	24 B	09 00 000 5209		





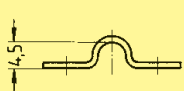
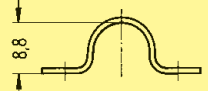
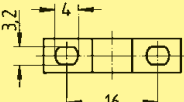
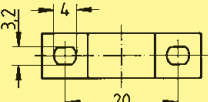



Technical characteristics

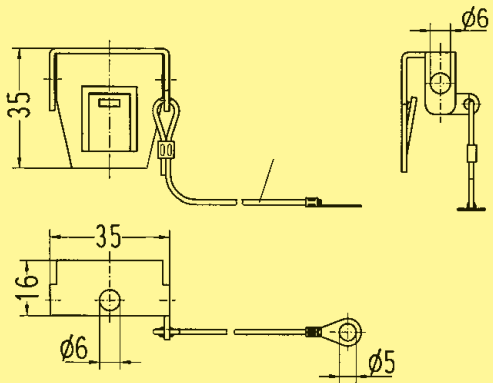
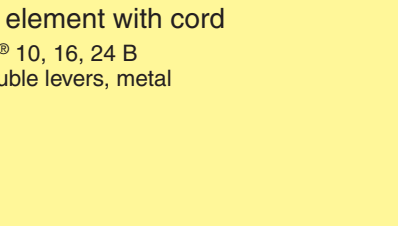
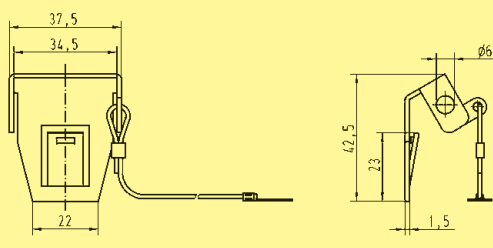

Material: steel, zinc plated

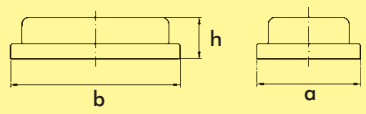
Identification	Part No.	Drawing	Dimensions in mm
Clamps for ground terminals	09 00 000 5341	cable Ø 5 mm 	
	09 00 000 5342	10 mm 	

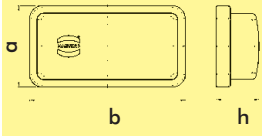
Identification	Size	Part No.	Drawing	Dimensions in mm
PE-screw for Han A®, Han® 15, 25 D for Han E® etc. for Han-Com®, Han® HsB for Han-Modular® hinged frames	M 3.5 M 4 M 5 M 3 M 4	09 20 000 9919 09 33 000 9925 09 33 000 9926 09 14 000 9953 09 14 000 9954		
Insert fixing screw	M 3	09 16 000 9903		
Contact screw for Stat®, Han® 3 A, 4 A	M 3	09 30 000 9997		
Han® 3 A Insert fixing screw	M 3	09 20 000 9995		
Han® 3 A Insert fixing screw IP 65 / IP 67	M 3 IP 65	09 20 000 9918		
Han-Compact® Insert fixing screw	ST 2,9 x 9,5 F-H	09 12 000 9921		
Han® HPR Locking screw for Han® 6 B, 10 B, 16 B and 24 B	M 6	09 40 000 9932		
Han® HPR Toggle locking screw for Han® 6 B, 10 B, 16 B and 24 B	–	09 40 000 9931		
Locking levers	3 A 3 A	09 00 000 5241 09 00 000 5242	grey black	
Han-Easy Lock® single levers	10 A 16 A	09 00 000 5224 09 00 000 5225		
	6 B 10 B 16 B 24 B	09 00 000 5222 09 00 000 5228 09 00 000 5229 09 00 000 5230		
Han-Easy Lock® double levers	10/16/ 24 B	09 00 000 5221		
	32 A 32 B	09 00 000 5223 09 00 000 5231		

Accessories

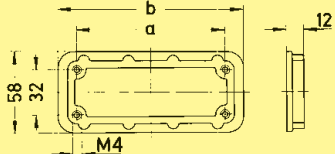
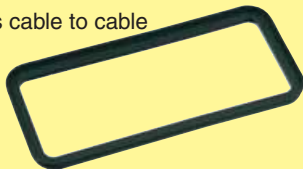
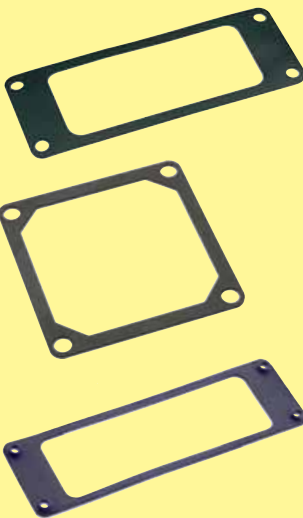
Identification	Size	Part No.	Drawing	Dimensions in mm																								
Locking element with cord for Han-Easy Lock® double levers and Han® 10, 16, 24 B housings bulkhead mounting 	10/16/ 24 B	09 30 000 9986																										
Locking element with cord for Han® 10, 16, 24 B with double levers, metal 	10/16/ 24 B	09 30 000 9987																										
Bearing pedestal for Han® 10 A, 16 A, 32 A 6 B, 10 B, 16 B, 24 B 		09 30 000 9964																										
Thermoplastic cover for bearing pedestal 	10 A 16 A 6 B 10 B 16 B 24 B	09 20 010 5410 09 20 016 5410 09 30 006 5410 09 30 010 5410 09 30 016 5410 09 30 024 5410																										
Dust protection cover for Han® B housings 	10 16 24	09 30 010 5406 09 30 016 5406 09 30 024 5406		<table border="1"> <thead> <tr> <th>Size</th> <th>a</th> <th>b</th> <th>h</th> </tr> </thead> <tbody> <tr> <td>10B</td> <td>45,2</td> <td>47,8</td> <td>18</td> </tr> <tr> <td>16B</td> <td>45,2</td> <td>95,3</td> <td>18</td> </tr> <tr> <td>24B</td> <td>45,2</td> <td>121,8</td> <td>18</td> </tr> </tbody> </table>	Size	a	b	h	10B	45,2	47,8	18	16B	45,2	95,3	18	24B	45,2	121,8	18								
Size	a	b	h																									
10B	45,2	47,8	18																									
16B	45,2	95,3	18																									
24B	45,2	121,8	18																									
Dust protection cover for Han® HPR housings 	3 A 6 B 10 B 16 B 24 B	09 40 003 5406 09 40 006 5406 09 40 010 5406 09 40 016 5406 09 40 024 5406		<table border="1"> <thead> <tr> <th>Size</th> <th>a</th> <th>b</th> <th>h</th> </tr> </thead> <tbody> <tr> <td>3A</td> <td>27.8</td> <td>45.7</td> <td>12.5</td> </tr> <tr> <td>6B</td> <td>55</td> <td>93.2</td> <td>29</td> </tr> <tr> <td>10B</td> <td>55</td> <td>106.2</td> <td>29</td> </tr> <tr> <td>16B</td> <td>55</td> <td>126.2</td> <td>29</td> </tr> <tr> <td>24B</td> <td>55</td> <td>153.2</td> <td>29</td> </tr> </tbody> </table>	Size	a	b	h	3A	27.8	45.7	12.5	6B	55	93.2	29	10B	55	106.2	29	16B	55	126.2	29	24B	55	153.2	29
Size	a	b	h																									
3A	27.8	45.7	12.5																									
6B	55	93.2	29																									
10B	55	106.2	29																									
16B	55	126.2	29																									
24B	55	153.2	29																									
Metal cover for bearing pedestal 	6 B 10 B 16 B 24 B	09 30 006 5403 09 30 010 5404 09 30 016 5404 09 30 024 5404																										

Identification	Size	Part No.	Drawing	Dimensions in mm															
Mounting frames for standard housings 	6 B	09 40 000 9921	 <table border="1" data-bbox="1059 499 1289 667"> <tr> <td></td> <td></td> <td></td> </tr> <tr> <td>6 B</td> <td>70</td> <td>96</td> </tr> <tr> <td>10 B</td> <td>83</td> <td>109</td> </tr> <tr> <td>16 B</td> <td>103</td> <td>129</td> </tr> <tr> <td>24 B</td> <td>130</td> <td>156</td> </tr> </table>				6 B	70	96	10 B	83	109	16 B	103	129	24 B	130	156	
	6 B	70		96															
	10 B	83		109															
	16 B	103		129															
24 B	130	156																	
10 B	09 40 000 9922																		
16 B	09 40 000 9923																		
24 B	09 40 000 9924																		
Identification	Size	Material NBR	Part No.	Material FPM															
L-seal for Hoods cable to cable 	6 B	09 30 000 9936																	
	10 B	09 30 000 9935																	
	16 B	09 30 000 9934																	
	24 B	09 30 000 9933																	
Gasket 	Modular Compact	09 14 000 9940																	
	3 A	09 20 000 9991	09 37 000 9912																
	10 A	09 20 000 9992																	
	16 A	09 20 000 9993																	
	32 A	09 20 000 9994																	
	Han-Drive	09 30 000 9903																	
	6 B	09 30 000 9801	09 37 000 9946																
	10 B	09 30 000 9802	09 37 000 9947																
	16 B	09 30 000 9803	09 37 000 9948																
	24 B	09 30 000 9804	09 37 000 9949																
48 B	09 30 000 9996																		
Profile seal 	3 A	09 70 000 9991	09 21 000 9906																
	10 A	09 20 000 9996																	
	16 A	09 20 000 9997																	
	6 B	09 30 000 9941																	
	10 B	09 30 000 9942																	
	16 B	09 30 000 9943																	
	24 B	09 30 000 9944																	
	48 B	09 30 000 9995																	
Han® HPR O-ring-sealing 	3 HPR	09 40 000 9910																	
	6 HPR	09 40 000 9911																	
	10 HPR	09 40 000 9912																	
	16 HPR	09 40 000 9913																	
	24 HPR	09 40 000 9914																	

Stock items in bold type