



BNC COAXIAL CONNECTORS

The Connex BNC connectors are made to a high quality level. Medium size coaxial connectors with bayonet lock. 50 ohm impedance for applications up to 4 GHz and 75 ohm impedance up to 2 GHz.

75 OHM SERIES

Within the internationally standardized BNC mating face dimensions, a perfect 75 ohm characteristic impedance cannot be realized. However, at frequencies up to 1000 MHz, the small impedance deviation is negligible for practical applications. Connex true 75 ohm connectors with a typical VSWR reading of 1.06:1 at 2000 MHz are identified by an asterisk following the part number.

All 75 ohm BNC connectors and 50 ohm BNC connectors are intermateable without restrictions.

Note: Silverplated bodies are available by adding "S" to end of part number. Nexcote (white bronze) plating with no nickel under body or center contact is available by adding "NEX" to end of part number.

ELECTRICAL SPECIFICATIONS

Impedance	50 ohm	75 ohm
Frequency Range	0–4 GHz	0–1 GHz
Working Voltage	500 Volts rms.	500 Volts rms.
Dielectric Withstanding Voltage	1500 Volts rms.	1500 Volts rms.
VSWR	1.3 max. 0–4 GHz	1.05+0.1f(GHz) DC to 1 GHz
Contact Resistance	Center contact 1.5 milliohm Outer contact 1.0 milliohm	Center contact 1.5 milliohm Outer contact 1.0 milliohm
Insulation Resistance	5000 megohms (min)	5000 megohms (min)

MATERIAL SPECIFICATIONS

PARTS NAME		MATERIAL	FINISH
Center Contact	Male	Brass	Gold or Silver plated
	Female	Phosphor Bronze (nominal) or Beryllium Copper	Gold or Silver plated
Metal parts		Brass	Nickel*
Insulators		Teflon, Delrin, PBT polyester	None
Clamp gaskets		Silicone rubber, Synthetic rubber	None
Crimp ferrule		Annealed copper	Nickel*



BNC COAXIAL CONNECTORS

INTERFACE MATING DIMENSIONS

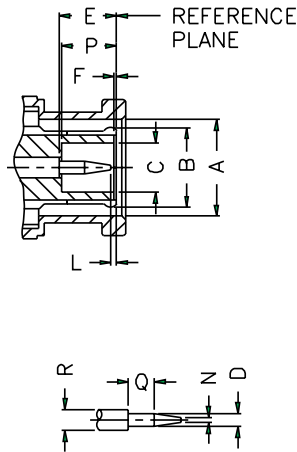

PLUG

Letter	Millimeters [Inches]	
	Minimum	Maximum
A	9.78 [.385]	9.91 [.390]
B	FLARED TO MEET GOOD ELECTRICAL CONTACT	
C	4.83 [.190]	–
D	1.32 [.052]	1.37 [.054]
E	5.33 [.210]	5.84 [.230]
F	0.15 [.006]	0.46 [.018]
L	0.08 [.003]	1.02 [.040]
N	–	0.64 [.025]
P	5.28 [.208]	5.79 [.228]
Q	1.98 [.078]	–
R	2.06 [.081]	2.21 [.087]

JACK

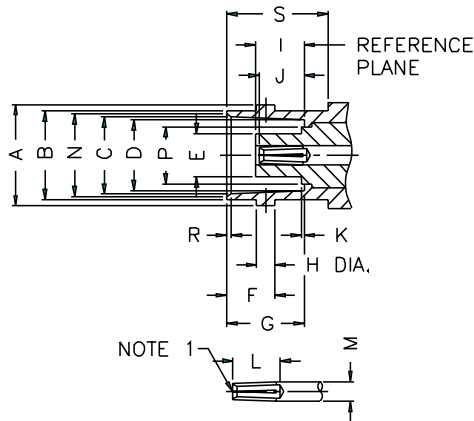

Letter	Millimeters [Inches]	
	Minimum	Maximum
A	10.97 [.432]	11.07 [.436]
B	9.60 [.378]	9.70 [.382]
C	8.31 [.327]	8.46 [.333]
D	8.10 [.319]	8.15 [.321]
E	–	4.72 [.186]
F	5.18 [.204]	5.28 [.208]
G	8.31 [.327]	8.51 [.335]
H	1.91 [.075]	2.06 [.081]
I	4.78 [.188]	5.28 [.208]
J	4.72 [.186]	5.23 [.206]
K	–	0.15 [.006]
L	4.95 [.195]	–
M	2.06 [.081]	2.21 [.087]
N	8.79 [.346]	9.04 [.356]
P	–	6.50 [.256]
R	0.38 [.015]	0.76 [.030]
S	10.52 [.414]	–

NOTE 1: I.D. TO MEET VSWR AND CONTACT RESISTANCE WHEN MATED WITH 1.32/1.37 MM DIA. PIN.

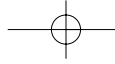

BNC COAXIAL CONNECTORS

All connector bodies, unless otherwise noted, are nickel plated. Center contacts are 3µ" gold plated. Insulators are Delrin, unless otherwise noted.

Silver plating and Teflon insulators are available on virtually all BNC connectors. Please contact Connex for samples and quotes.

All dimensions in millimeters and [inches].

C A B L E G R O U P L E G E N D			
01	58/ 58A/ 58C/ 141/ 303/ LMR195™/ B7806A	06A	179/ U DOUBLE BRAIDED
01A	55/ 142/ 223/ 400	07	8/ 8A/ 213/ 393
01B	LMR200™/ B7807A	07A	214
02	58 PLENUM/THINNET/ 122U/ B88240/ B89907	07B	8X/ LMR240™/ B7808A
03	59/ 62/ 140/ 210	07C	B9913/ LMR400™/ B7810A/ B8214
03A	59/ U-20AWG	07D	B89913
04	59/ U PLENUM	07E	11
04A	59/ U PLENUM-20AWG	07F	11/ U-14AWG/ B8213/ B9292/ B7731/ B1859A
05	174/ 188A/ 316/ B7805A	08	6/ 143/ 212
05A	316/ U DOUBLE BRAIDED	08A	B1694A/ B9248
06	179/ 187/ B9221	08B	6 PLENUM/ B1695A
		09	B8227/ 89207
		10	.141 SEMI-RIGID/ 402/U
		11	.085 SEMI-RIGID/ 405/U
		12	.250 SEMI-RIGID
		13	.047 SEMI-RIGID/ B1674A
		14	178/ 196
		15	B8281/ B9231/ B9141
		15A	B88281
		16	180/ 195/ 122/ B8218/ B1865A/ B1855
		17	LMR600™
		18	AT&T734A/ B1505A
		19	AT&T735A/ B735A1

PLUG CRIMP ATTACHMENTS FOR FLEXIBLE CABLE

STRAIGHT CRIMP PLUG — SINGLE CRIMP

P.N.	Cable Group	Finish	Insulation	Impedance	Crimp Tool
Diecast shell					
112108	01	Nickel	Delrin	50	E
112110	03	Nickel	Delrin	50	E
112112	02	Nickel	Delrin	50	E
112114	04	Nickel	Delrin	50	E

Remark: Only for Solid Center Conductor Cable

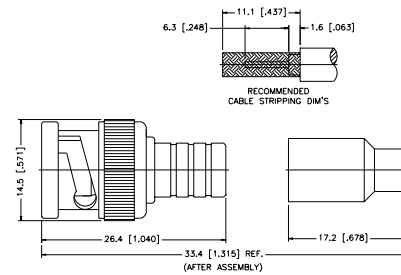

STRAIGHT CRIMP PLUG — CAPTIVE CONTACT — STANDARD CABLE

P.N.	Cable Group	Finish	Insulation	Impedance	Crimp Tool
Brass Shell					
112116	01	Nickel	Delrin	50	A
112514	01A	Nickel	Delrin	50	A
112597	01B	Nickel	Teflon	50	A
112118	03	Nickel	Delrin	50	A
112119	03	Nickel	Delrin	75	A
112952*	03	Nickel	Teflon	75	A
112507	03A	Nickel	Delrin	75	A
112956*	03A	Nickel	Teflon	75	A
112650	—	Nickel	Teflon	75	A
COMMSCOPE F59 HEC-2/B1186A CABLE					
112562	07	Nickel	Teflon	50	D
112589	07A	Nickel	Teflon	50	D
112533	07B	Nickel	Delrin	50	A
112563	07C	Nickel	Teflon	50	L
112627	07D	Nickel	Teflon	50	L
112576	07E	Nickel	Teflon	75	D
112669	07E	Nickel	Teflon	50	D
112606	07F	Nickel	Teflon	75	D
112508	08	Nickel	Delrin	75	E
112565	08A	Nickel	Delrin	75	E
112957*	08A	Nickel	Teflon	75	H
112519	08B	Nickel	Delrin	75	E
112958*	08B	Nickel	Teflon	75	E
112509	15	Nickel	Delrin	75	E
112953*	15	Nickel	Teflon	75	E
112625	15A	Nickel	Delrin	75	E
112951*	18	Nickel	Teflon	75	A
112950*	19	Nickel	Teflon	75	B
112700	LMR300™	Nickel	Teflon	50	D/E

Diecast Shell					
112120	01	Nickel	Delrin	50	A
112122	03	Nickel	Delrin	50	A
112123	03	Nickel	Delrin	75	A

*Center contact .053" diameter, 30µ" Au. True 75 ohm. Use .044 hex or 12-indent crimp

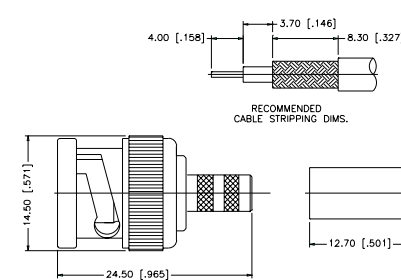
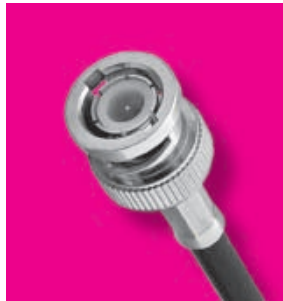

BNC COAXIAL CONNECTORS

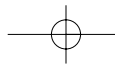

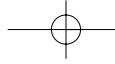

PLUG CRIMP ATTACHMENTS FOR FLEXIBLE CABLE

For Cable Group Legend, see page 69

STRAIGHT CRIMP PLUG — CAPTIVE CONTACT — PLENUM CABLE

P.N.	Cable Group	Finish	Insulation	Impedance	Crimp Tool
Brass Shell					
112124	02	Nickel	Delrin	50	A
112127	04	Nickel	Delrin	75	A
112544	04A	Nickel	Delrin	75	A
Diecast Shell					
112128	02	Nickel	Delrin	50	A

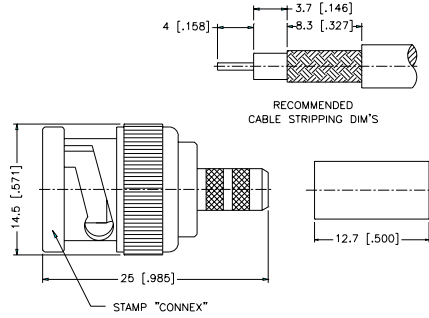
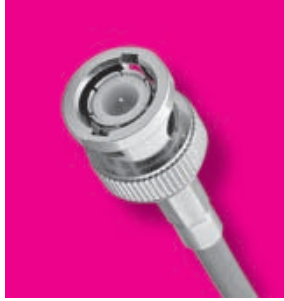

STRAIGHT CRIMP PLUG — CAPTIVE CONTACT — MINIATURE CABLE

P.N.	Cable Group	Finish	Insulation	Impedance	Crimp Tool
Brass Shell					
112132	05	Nickel	Delrin	50	B
112512	05A	Nickel	Delrin	50	B
112133	06	Nickel	Delrin	75	B
112644	06A	Nickel	Delrin	75	B
112516	14	Nickel	Delrin	50	B
112521	16	Nickel	Delrin	75	B
112955*	16	Nickel	Teflon	75	B
112975*	04A	Nickel	Teflon	75	B
Diecast Shell					
112134	05	Nickel	Delrin	50	B
112135	06	Nickel	Delrin	75	B

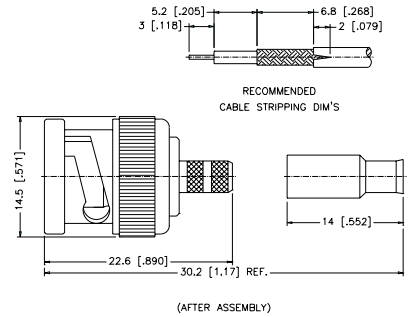

Remark: With teflon sleeve/Hex crimp size.178"
 *Center contact .053" diameter, 30µ Au.
 True 75 ohm. Use .044 hex or 12-indent crimp

STRAIGHT SOLDER PLUG — SEMI-RIGID CABLE

P.N.	Cable Group	Finish	Insulation	Impedance	Crimp Tool
112551	10	Nickel/Gold	Teflon	50	N/A
112520	10	Nickel/Gold	Teflon	75	N/A
112552	11	Nickel/Gold	Teflon	50	N/A

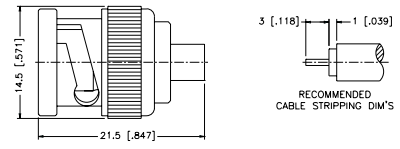
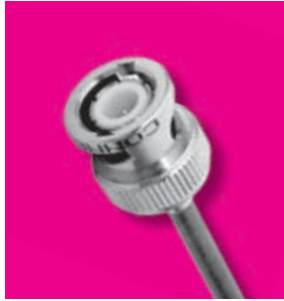

112551

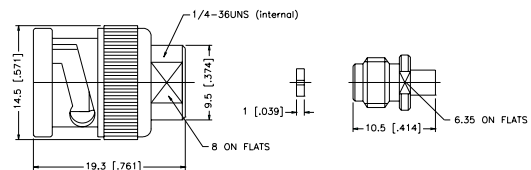
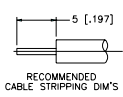

112552

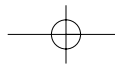

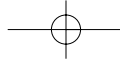

PLUG CRIMP ATTACHMENTS FOR FLEXIBLE CABLE

For Cable Group Legend, see page 69

STRAIGHT CRIMP PLUG — PIN-IN-PIN — MINIATURE CABLE

P.N.	Cable Group	Finish	Insulation	Impedance	Crimp Tool
Brass Shell					
112136	05	Nickel	Delrin	50	B
112137	06	Nickel	Delrin	75	B
Diecast Shell					
112138	05	Nickel	Delrin	50	B
112139	06	Nickel	Delrin	75	B

Remark: Hex. crimp size .128"

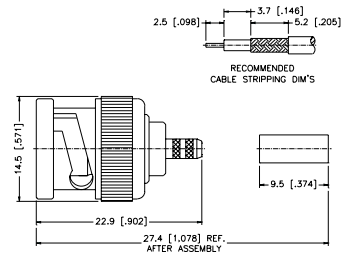
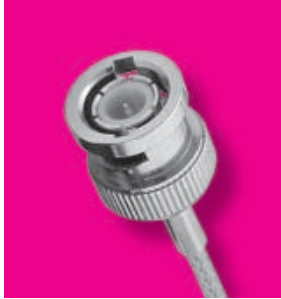

4-Way Indent Crimp
Tool No. 47001



Ferrule Crimp Tool Crimped Size .128"
Tool No. 47-10150

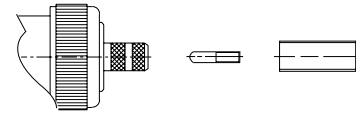

STRAIGHT CRIMP PLUG — MINIATURE CABLE

P.N.	Cable Group	Finish	Insulation	Impedance	Crimp Tool
Brass Shell					
112140	06	Nickel	TPX	75	B
Diecast Shell					
112142	06	Nickel	TPX	75	B

Remark: TPX Insulator/75 ohm AVAILABLE ONLY

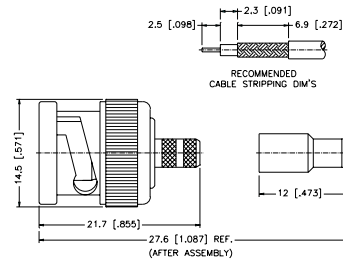

For Reverse Polarized connectors, add RP to standard part number. Contact Connex marketing for availability.
For Crimp Tool information, see page 183.

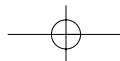

RIGHT ANGLE PLUG CRIMP ATTACHMENTS FOR FLEXIBLE CABLE

For Cable Group Legend, see page 69

RIGHT ANGLE CRIMP/SOLDER PLUG — STANDARD CABLE

P.N.	Cable Group	Finish	Insulation	Impedance	Crimp Tool
Brass Shell					
112162	01	Nickel	Delrin	50	A
112526	01A	Nickel	Delrin	50	A
112599	01B	Nickel	Teflon	50	A
112164	03	Nickel	Delrin	50	A
112165	03	Nickel	Delrin	75	A
112960*	03	Nickel	Teflon	75	A
112467	01	Nickel	Teflon	50	A
112470	03	Nickel	Teflon	75	A
112594	07	Nickel	Teflon	50	D
112595	07A	Nickel	Teflon	50	D
112601	07B	Nickel	Delrin	50	A
112596	07C	Nickel	Delrin	50	D
112961*	18	Nickel	Teflon	75	A
112962*	19	Nickel	Teflon	75	B

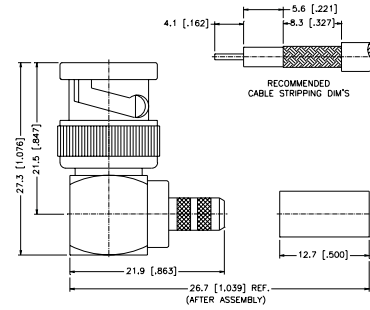

P.N.	Cable Group	Finish	Insulation	Impedance	Crimp Tool
Diecast Shell					
112166	01	Nickel	Delrin	50	A
112168	03	Nickel	Delrin	50	A
112169	03	Nickel	Delrin	75	A

Remark: Cable Center Conductor Solder to pin directly

*Center contact .053" diameter, 30µ" Au.
True 75 ohm. Use .044 hex or 12-indent crimp

RIGHT ANGLE CRIMP/SOLDER PLUG — PLENUM CABLE

P.N.	Cable Group	Finish	Insulation	Impedance	Crimp Tool
Brass Shell					
112170	02	Nickel	Delrin	50	A
112173	04	Nickel	Delrin	75	A
Diecast Shell					
112174	02	Nickel	Delrin	50	A
112177	04	Nickel	Delrin	75	A

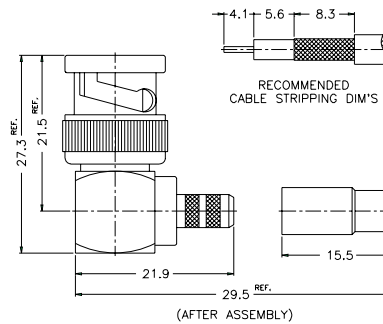
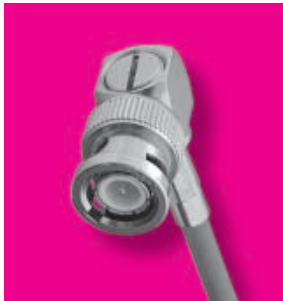

Remark: Cable Center Conductor Solder to pin directly

RIGHT ANGLE CRIMP/SOLDER PLUG — MINIATURE CABLE

P.N.	Cable Group	Finish	Insulation	Impedance	Crimp Tool
Brass Shell					
112178	05	Nickel	Delrin	50	B
112528	05A	Nickel	Delrin	50	B
112179	06	Nickel	Delrin	75	B
112646	06A	Nickel	Delrin	75	B
112588	16	Nickel	Delrin	75	B

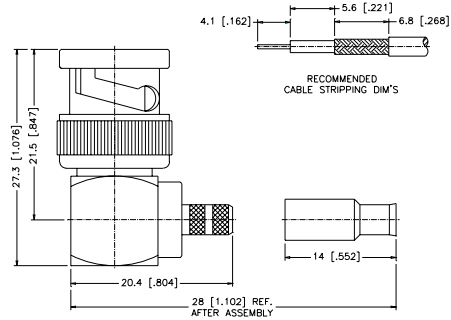

Remark: Cable Center Conductor Solder to pin directly

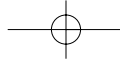

RIGHT ANGLE PLUG CRIMP ATTACHMENTS FOR FLEXIBLE CABLE

For Cable Group Legend, see page 69

RIGHT ANGLE SOLDER PLUG — SEMI-RIGID CABLE

P.N.	Cable Group	Finish	Insulation	Impedance	Crimp Tool
112617	10	Nickel/Gold	Teflon	50	N/A
112614	11	Nickel/Gold	Teflon	50	N/A

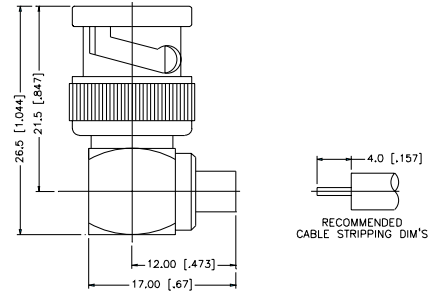

RIGHT ANGLE CRIMP/CRIMP PLUG — STANDARD CABLE

P.N.	Cable Group	Finish	Insulation	Impedance	Crimp Tool
Brass Shell					
112182	01	Nickel	Delrin	50	A
112184	03	Nickel	Delrin	50	A
112185	03	Nickel	Delrin	75	A
112540	08	Nickel	Teflon	75	E
112539	15	Nickel	Teflon	75	A
Diecast Shell					
112186	01	Nickel	Delrin	50	A
112189	03	Nickel	Delrin	75	A

Remark: Crimp/Crimp Type

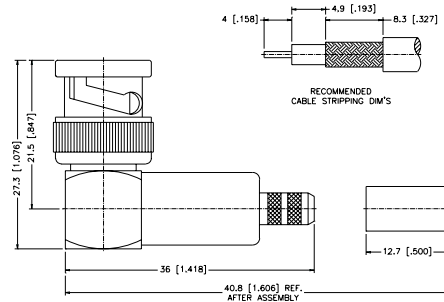

RIGHT ANGLE CRIMP/CRIMP PLUG — PLENUM CABLE

P.N.	Cable Group	Finish	Insulation	Impedance	Crimp Tool
Brass Shell					
112190	02	Nickel	Delrin	50	A
112193	04	Nickel	Delrin	75	A
Diecast Shell					
112194	02	Nickel	Delrin	50	A
112197	04	Nickel	Delrin	75	A

Remark: Crimp/Crimp Type

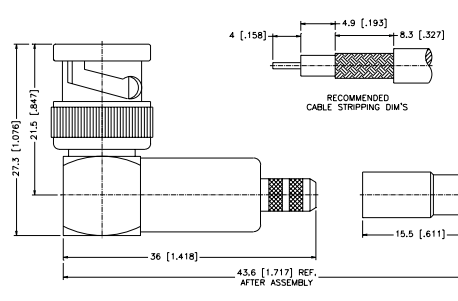

RIGHT ANGLE CRIMP/CRIMP PLUG — MINIATURE CABLE

P.N.	Cable Group	Finish	Insulation	Impedance	Crimp Tool
Brass Shell					
112198	05	Nickel	Delrin	50	B
112199	06	Nickel	Delrin	75	B
Diecast Shell					
112200	05	Nickel	Delrin	50	B
112201	06	Nickel	Delrin	75	B

Remark: With teflon sleeve Hex. crimp size .178" Crimp/Crimp Type

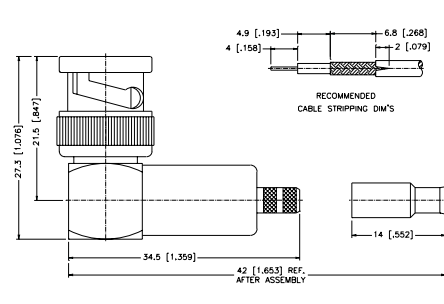

For Reverse Polarized connectors, add RP to standard part number. Contact Connex marketing for availability.
For Crimp Tool information, see page 183.

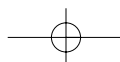

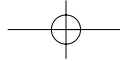

JACK CRIMP ATTACHMENTS FOR FLEXIBLE CABLE

For Cable Group Legend, see page 69

STRAIGHT CRIMP JACK — STANDARD CABLE

P.N.	Cable Group	Finish	Insulation	Impedance	Crimp Tool
Captured					
112144	01	Nickel	Teflon	50	A
112148	01	Nickel	Delrin	50	A
112513	01A	Nickel	Delrin	50	A
112598	01B	Nickel	Teflon	50	A
112146	03	Nickel	Teflon	50	A
112147	03	Nickel	Teflon	75	A
112150	03	Nickel	Delrin	50	A
112649	03A	Nickel	Teflon	75	A
112605	07B	Nickel	Teflon	50	A
112603	07C	Nickel	Teflon	50	D
112965*	08A	Nickel	Teflon	75	H
112966*	08B	Nickel	Teflon	75	E
112628	15	Nickel	Teflon	75	E
112973*	18	Nickel	Teflon	75	A
112974*	19	Nickel	Teflon	75	B

*Center contact .052" diameter, 30µ" Au. True 75 ohm. Use .044 hex or 12-indent crimp

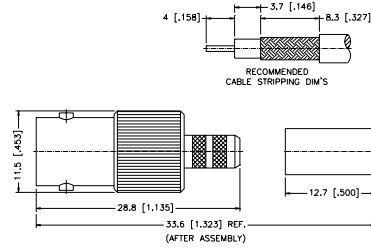

STRAIGHT CRIMP JACK — PLENUM CABLE

P.N.	Cable Group	Finish	Insulation	Impedance	Crimp Tool
Teflon/Captured					
112152	02	Nickel	Teflon	50	A
112155	04	Nickel	Teflon	75	A
112645	04A	Nickel	Teflon	75	A

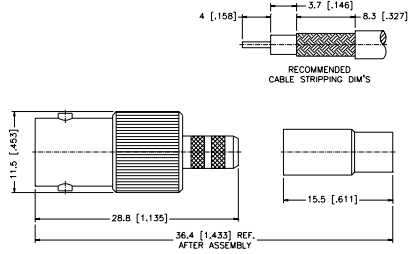
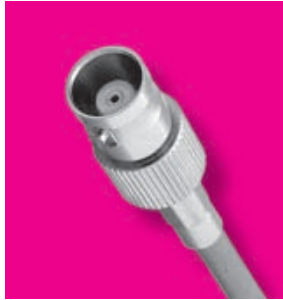

STRAIGHT CRIMP JACK — MINIATURE AND SEMI-RIGID CABLE

P.N.	Cable Group	Finish	Insulation	Impedance	Crimp Tool
112160	05	Nickel	Delrin	50	B
112529	05A	Nickel	Teflon	50	B
112161	06	Nickel	Delrin	75	B
112647	06A	Nickel	Delrin	75	B
112618	10	Nickel/Gold	Teflon	50	N/A
112615	11	Nickel/Gold	Teflon	50	N/A
112631	14	Nickel	Delrin	50	B
112559	16	Nickel	Delrin	75	B

Remark: With teflon sleeve, Hex crimp size .178"

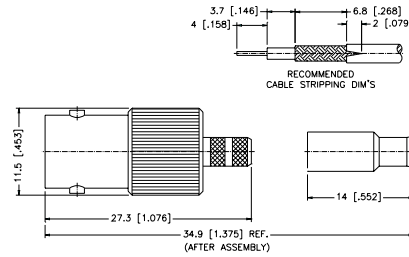

BULKHEAD CRIMP JACK — SNAP-IN PANEL

P.N.	Cable Group	Finish	Insulation	Impedance	Crimp Tool
112636	05	Nickel	Teflon	50	B

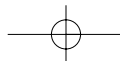
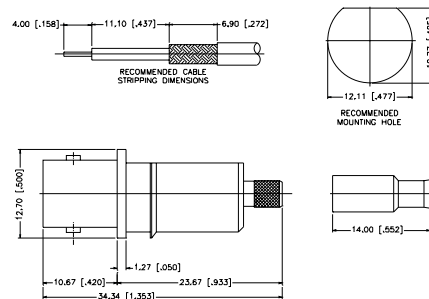

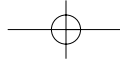

BULKHEAD JACK CRIMP ATTACHMENTS FOR FLEXIBLE CABLE

For Cable Group Legend, see page 69

BULKHEAD CRIMP JACK — STANDARD CABLE

P.N.	Cable Group	Finish	Insulation	Impedance	Crimp Tool
Teflon/Captured					
112202	01	Nickel	Teflon	50	A
112505	01A	Nickel	Teflon	50	A
112600	01B	Nickel	Teflon	50	A
112204	03	Nickel	Teflon	50	A
112205	03	Nickel	Teflon	75	A
112630	03A	Nickel	Teflon	75	A
112602	07B	Nickel	Teflon	50	A
112604	07C	Nickel	Teflon	50	L
112662	08A	Nickel	Teflon	75	E
112982	08A	Nickel	Teflon	75	E
112593	08B	Nickel	Teflon	50	E
112629	15	Nickel	Teflon	75	E
Delrin/Non Captured					
112206	01	Nickel	Delrin	50	A
112208	03	Nickel	Delrin	50	A
112209	03	Nickel	Delrin	75	A

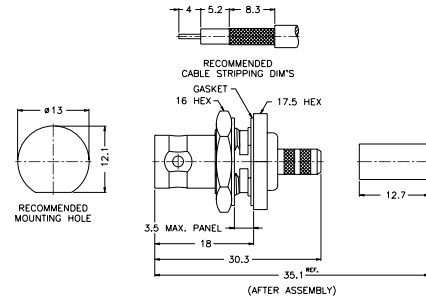

Remark: 3.5 [.138] Max. panel thickness
 *Center contact .053" diameter, 30µ" Au.
 True 75 ohm. Use .044 hex or 12-indent crimp

BULKHEAD CRIMP JACK — STANDARD CABLE

P.N.	Cable Group	Finish	Insulation	Impedance	Crimp Tool
Teflon/Captured					
112210	01	Nickel	Teflon	50	A
112213	03	Nickel	Teflon	75	A

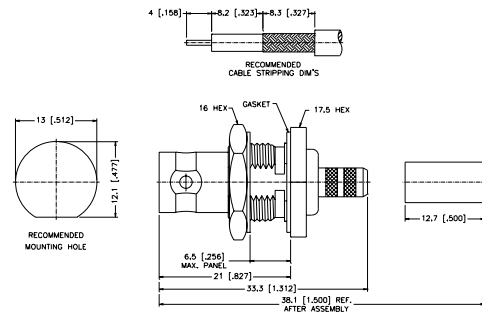

Remark: 6.5 [.256] Max. panel thickness

BULKHEAD CRIMP JACK — PLENUM CABLE

P.N.	Cable Group	Finish	Insulation	Impedance	Crimp Tool
Teflon/Captured					
112218	02	Nickel	Teflon	50	A
112221	04	Nickel	Teflon	75	A

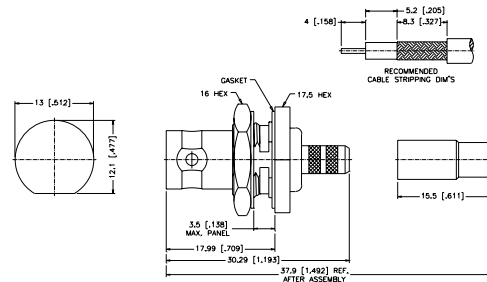

Remark: 3.5 [.138] Max. panel thickness

For Reverse Polarized connectors, add RP to standard part number. Contact Connex marketing for availability.
 For Crimp Tool information, see page 183.

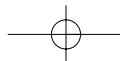

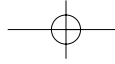

BULKHEAD JACK CRIMP ATTACHMENTS FOR FLEXIBLE CABLE

For Cable Group Legend, see page 69

BULKHEAD CRIMP JACK — PLENUM CABLE

P.N.	Cable Group	Finish	Insulation	Impedance	Crimp Tool
Teflon/Captured					
112226	02	Nickel	Teflon	50	A
112229	04	Nickel	Teflon	75	A

Remark: 6.5 [.256] Max. panel thickness

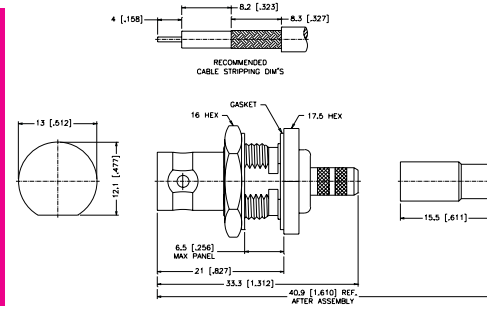

BULKHEAD CRIMP JACK — MINIATURE CABLE

P.N.	Cable Group	Finish	Insulation	Impedance	Crimp Tool
112234	05	Nickel	Delrin	50	B
112517	05A	Nickel	Delrin	50	B
112635	05A	Nickel	Teflon	50	C
FRONT MOUNT					
112235	06	Nickel	Delrin	75	B
112654	06	Nickel	Teflon	75	B
FRONT MOUNT					
112648	06A	Nickel	Delrin	75	B
112522	14	Nickel	Delrin	50	B
112568	16	Nickel	Teflon	75	B
112970*	18	Nickel	Teflon	75	A
112969*	19	Nickel	Teflon	75	B

*Center contact .052" diameter, 30µ" Au, true 75 ohm. Use .044 Hex. crimp or 12-indent crimp.

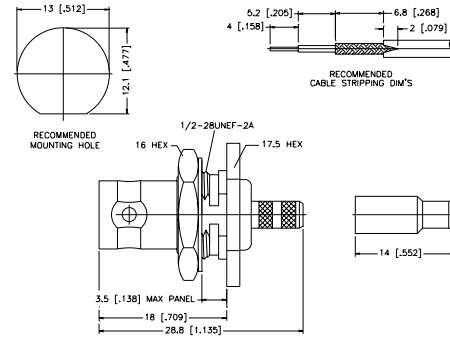

112587	05	Nickel	Teflon	50	B
FRONT MOUNT					
112634	05A	Nickel	Teflon	50	C
FRONT MOUNT					

Remark: With teflon sleeve, Hex. crimp size .178", 3.5 [.138] Max. panel thickness

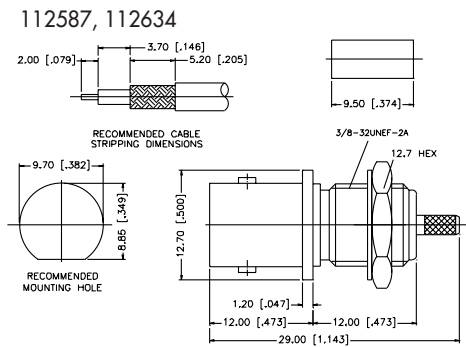

BULKHEAD SOLDER JACK — SEMI-RIGID CABLE

P.N.	Cable Group	Finish	Insulation	Impedance	Crimp Tool
112581	10	Nickel/Gold	Teflon	50	N/A
112580	11	Nickel/Gold	Teflon	50	N/A
112609	11	Nickel/Gold	Teflon	50	N/A
FRONT MOUNT					
112632	11	Nickel/Gold	Teflon	75	N/A
FRONT MOUNT					

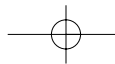
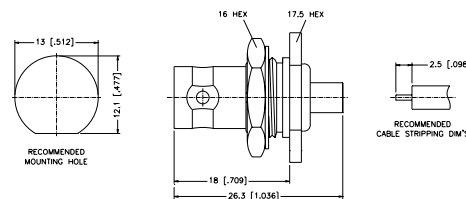

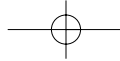

BULKHEAD JACK CRIMP ATTACHMENTS FOR FLEXIBLE CABLE

For Cable Group Legend, see page 69

BULKHEAD ISOLATED CRIMP JACK — STANDARD CABLE

P.N.	Cable Group	Finish	Insulation	Impedance	Crimp Tool
Teflon/Captured					
112236	01	Nickel	Teflon	50	A
112652	01A	Nickel	Teflon	50	A
112238	03	Nickel	Teflon	50	A
112239	03	Nickel	Teflon	75	A

Remark: 6.0 [.236] Max. panel thickness

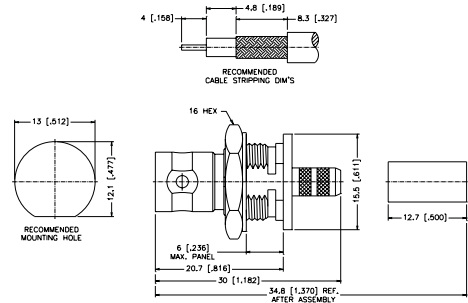
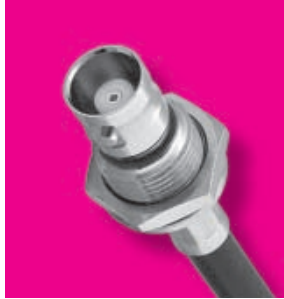

BULKHEAD ISOLATED CRIMP JACK — PLENUM CABLE

P.N.	Cable Group	Finish	Insulation	Impedance	Crimp Tool
112244	02	Nickel	Teflon	50	A
112247	04	Nickel	Teflon	75	A

Remark: 6.0 [.236] Max. panel thickness

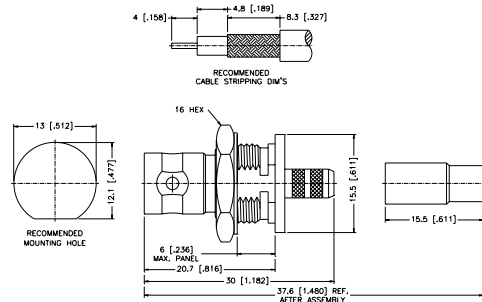

BULKHEAD ISOLATED CRIMP JACK — MINIATURE CABLE

P.N.	Cable Group	Finish	Insulation	Impedance	Crimp Tool
112252	05	Nickel	Teflon	50	B
112253	06	Nickel	Teflon	75	B

Remark: 6.0 [.236] Max. panel thickness

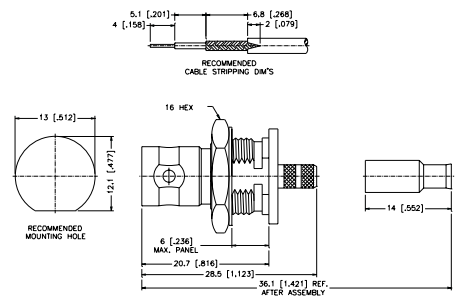

For Reverse Polarized connectors, add RP to standard part number. Contact Connex marketing for availability. For Crimp Tool information, see page 183.

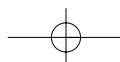

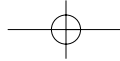

PANEL JACK CRIMP ATTACHMENTS FOR FLEXIBLE CABLE/RECEPTACLE For Cable Group Legend, see page 69

PANEL CRIMP JACK — STANDARD CABLE

P.N.	Cable Group	Finish	Insulation	Impedance	Crimp Tool
Teflon/Captured					
112272	01	Nickel	Teflon	50	A
112527	01A	Nickel	Delrin	50	A
112274	03	Nickel	Teflon	50	A
112275	03	Nickel	Teflon	75	A

Remark: 5.0 [.197] Max. panel thickness

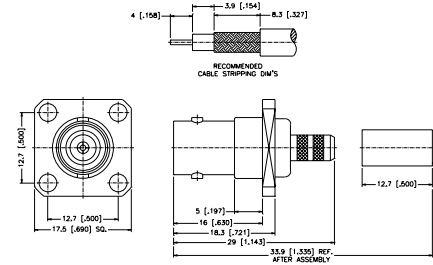

PANEL CRIMP JACK — PLENUM CABLE

P.N.	Cable Group	Finish	Insulation	Impedance	Crimp Tool
Teflon/Captured					
112280	02	Nickel	Teflon	50	A
112283	04	Nickel	Teflon	75	A

Remark: 5.0 [.197] Max. panel thickness

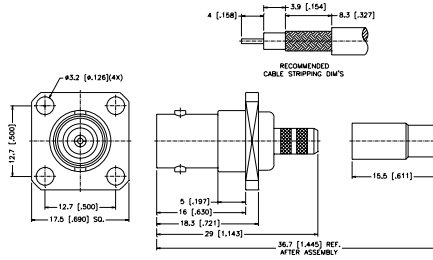

PANEL CRIMP JACK — MINIATURE AND SEMI-RIGID CABLE

P.N.	Cable Group	Finish	Insulation	Impedance	Crimp Tool
112288	05	Nickel	Delrin	50	B
112530	05A	Nickel	Delrin	50	B
112289	06	Nickel	Delrin	75	B
112619	10	Nickel/Gold	Teflon	50	N/A
112616	11	Nickel/Gold	Teflon	50	N/A

Remark: 5.0 [.197] Max. panel thickness

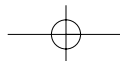
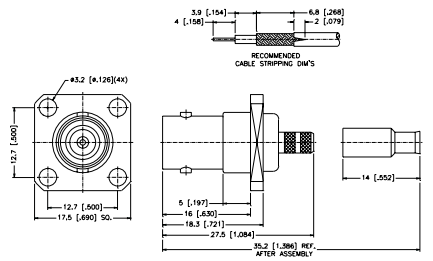

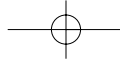

CLAMP ATTACHMENTS FOR FLEXIBLE CABLE

For Cable Group Legend, see page 69

STRAIGHT CLAMP PLUG — CAPTIVE CONTACT

P.N.	Cable Group	Finish	Insulation	Impedance	Crimp Tool
Brass shell					
112332	01	Nickel	Delrin	50	N/A
112334	03	Nickel	Delrin	50	N/A
112335	03	Nickel	Delrin	75	N/A
112531	07	Nickel	Teflon	50	N/A
112558	07E	Nickel	Teflon	75	N/A
112657	07F	Nickel	Teflon	75	N/A

Remark: Barrel O.D. = 12.5 mm

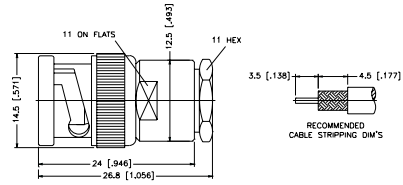

STRAIGHT CLAMP PLUG — CAPTIVE CONTACT

P.N.	Cable Group	Finish	Insulation	Impedance	Crimp Tool
Brass Shell					
112348	01	Nickel	Delrin	50	N/A
112350	03	Nickel	Delrin	50	N/A
112351	03	Nickel	Delrin	75	N/A
112477	06	Nickel	Teflon	75	N/A

P.N.	Cable Group	Finish	Insulation	Impedance	Crimp Tool
Diecast Shell					
112352	01	Nickel	Delrin	50	N/A
112354	03	Nickel	Delrin	50	N/A

Remark: UG-88/U, UG-260/U

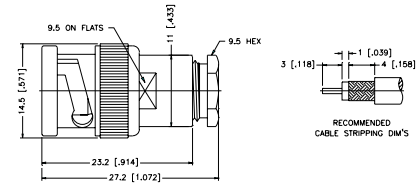
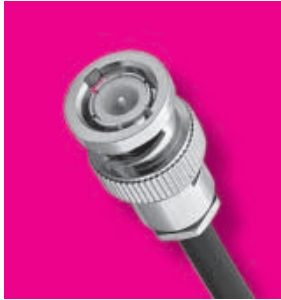

RIGHT ANGLE CLAMP PLUG

P.N.	Cable Group	Finish	Insulation	Impedance	Crimp Tool
Brass Shell					
112356	01	Nickel	Delrin	50	N/A
112358	03	Nickel	Delrin	50	N/A
112359	03	Nickel	Delrin	75	N/A
112360	02	Nickel	Delrin	50	N/A
112362	04	Nickel	Delrin	50	N/A
112363	04	Nickel	Delrin	75	N/A

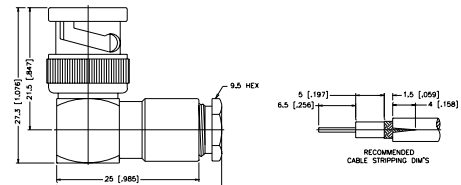
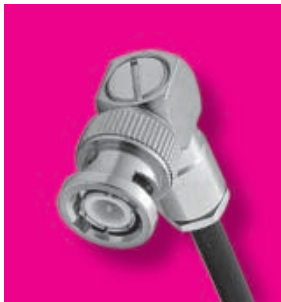

STRAIGHT CLAMP JACK — CAPTIVE CONTACT

P.N.	Cable Group	Finish	Insulation	Impedance	Crimp Tool
112372	01	Nickel	Teflon	50	N/A
112374	03	Nickel	Teflon	50	N/A
112375	03	Nickel	Teflon	75	N/A
112376	02	Nickel	Teflon	50	N/A
112378	04	Nickel	Teflon	50	N/A
112379	04	Nickel	Teflon	75	N/A
112642	07	Nickel	Teflon	50	N/A

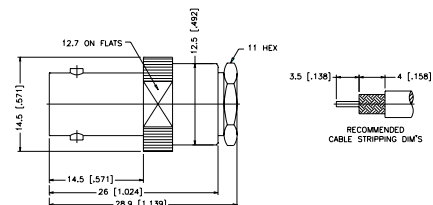

For Reverse Polarized connectors, add RP to standard part number. Contact Connex marketing for availability.
For Crimp Tool information, see page 183.

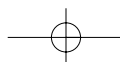

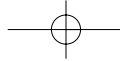

CLAMP ATTACHMENTS FOR FLEXIBLE CABLE

For Cable Group Legend, see page 69

BULKHEAD CLAMP JACK — CAPTIVE CONTACT

P.N.	Cable Group	Finish	Insulation	Impedance	Crimp Tool
112577	01	Nickel	Teflon	50	N/A
112612	05	Nickel	Teflon	50	N/A
112613	06	Nickel	Teflon	75	N/A

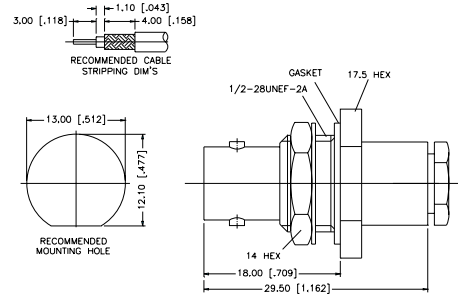

TWIST-ON ATTACHMENTS FOR FLEXIBLE CABLE

TWIST-ON PLUG

P.N.	Cable Group	Finish	Insulation	Impedance	Crimp Tool
Brass Shell					
112292	01	Nickel	Delrin	50	N/A
112294	03	Nickel	Delrin	50	N/A
112295	03	Nickel	Delrin	75	N/A
112296	02	Nickel	Delrin	50	N/A
112298	04	Nickel	Delrin	50	N/A
112299	04	Nickel	Delrin	75	N/A
112485	08	Nickel	Delrin	75	N/A
Diecast Shell					
112300	01	Nickel	Delrin	50	N/A
112302	03	Nickel	Delrin	50	N/A
112303	03	Nickel	Delrin	75	N/A
112486	08	Nickel	Delrin	75	N/A

Remark: Only for solid center conductor cable

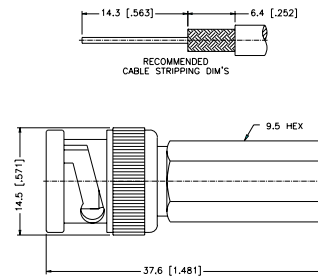

TWIST-ON JACK

P.N.	Cable Group	Finish	Insulation	Impedance	Crimp Tool
112308	01	Nickel	Delrin	50	N/A
112310	03	Nickel	Delrin	50	N/A
112312	02	Nickel	Delrin	50	N/A
112314	04	Nickel	Delrin	50	N/A

Remark: Only for solid center conductor cable

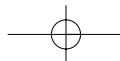
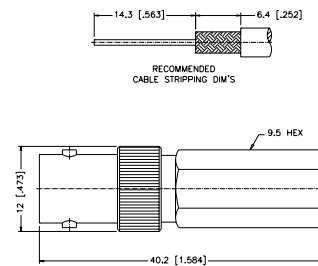

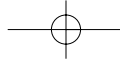

TWIST-ON ATTACHMENTS FOR FLEXIBLE CABLE

For Cable Group Legend, see page 69

RIGHT ANGLE TWIST-ON PLUG

P.N.	Cable Group	Finish	Insulation	Impedance	Crimp Tool
Diecast Shell					
112324	01	Nickel	Delrin	50	N/A
112326	03	Nickel	Delrin	50	N/A
112327	03	Nickel	Delrin	75	N/A
112328	02	Nickel	Delrin	50	N/A
112330	04	Nickel	Delrin	50	N/A

Remark: Only for solid center conductor cable

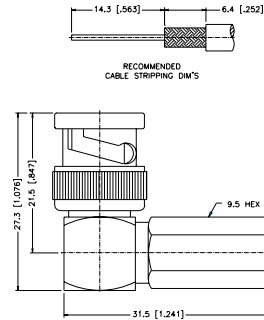

WEDGE COMPRESSION ATTACHMENTS FOR FLEXIBLE CABLE

WEDGE COMPRESSION PLUG

P.N.	Cable Group	Finish	Insulation	Impedance	Crimp Tool
Brass Shell					
112380	01	Nickel	Delrin	50	N/A
112382	03	Nickel	Delrin	50	N/A
112383	03	Nickel	Delrin	75	N/A
112384	02	Nickel	Delrin	50	N/A
112386	04	Nickel	Delrin	50	N/A
112387	04	Nickel	Delrin	75	N/A

Remark: With wedge pin

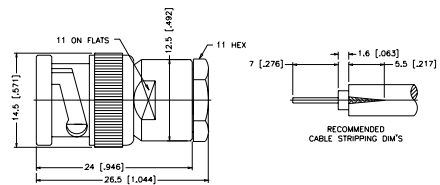

WEDGE COMPRESSION JACK

P.N.	Cable Group	Finish	Insulation	Impedance	Crimp Tool
112396	01	Nickel	Teflon	50	N/A
112398	03	Nickel	Teflon	50	N/A
112399	03	Nickel	Teflon	75	N/A
112400	02	Nickel	Teflon	50	N/A
112402	04	Nickel	Teflon	50	N/A
112403	04	Nickel	Teflon	75	N/A

Remark: With wedge contact

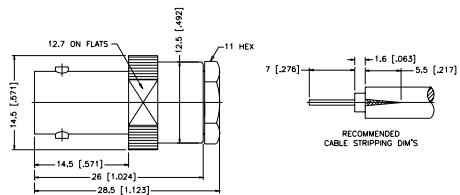

For Reverse Polarized connectors, add RP to standard part number. Contact Connex marketing for availability.
For Crimp Tool information, see page 183.

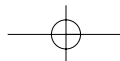

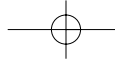

BULKHEAD RECEPTACLE/SOLDER POT TERMINALS

For Cable Group Legend, see page 69

BULKHEAD RECEPTACLE PLUG

P.N.	Cable Group	Finish	Insulation	Impedance	Crimp Tool
Brass Shell					
112420	N/A	Nickel	Delrin	50	N/A
112421	N/A	Nickel	Delrin	75	N/A

Remark: 4.5 [1.77] Max. panel thickness

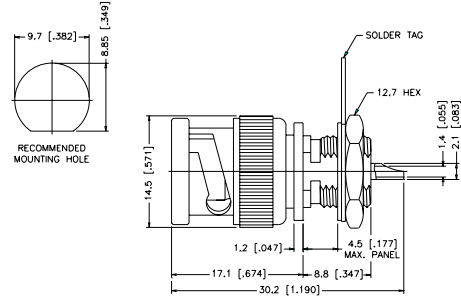

BULKHEAD RECEPTACLE JACK

P.N.	Cable Group	Finish	Insulation	Impedance	Crimp Tool
L1 = 3.2 [0.126] Max. panel thickness, L = 26.7 [1.05]					
112424	N/A	Nickel	Delrin	50	N/A
112424T	N/A	Nickel	Teflon	50	N/A
112575 N/A Nickel Delrin 50 N/A DIE CAST BODY					
112575-75 N/A Nickel Delrin 75 N/A DIE CAST BODY					
112425	N/A	Nickel	Delrin	75	N/A
L1 = 6.5 [0.256] Max. panel thickness, L = 30.0 [1.18]					
112426	N/A	Nickel	Delrin	50	N/A
112427	N/A	Nickel	Delrin	75	N/A

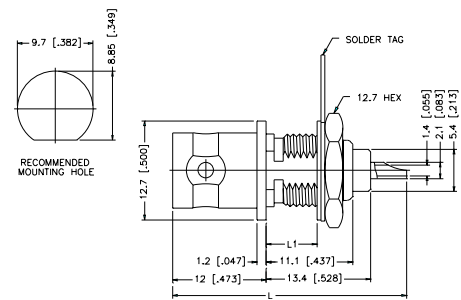

L1 = 9.5 [0.374] Max. panel thickness, L = 33.0 [1.30]					
112428	N/A	Nickel	Delrin	50	N/A
112429	N/A	Nickel	Delrin	75	N/A

BULKHEAD RECEPTACLE ISOLATED JACK

P.N.	Cable Group	Finish	Insulation	Impedance	Crimp Tool
112431	N/A	Nickel	ABS	50	N/A
112432	N/A	Nickel	ABS	75	N/A

Remark: Isolated from ground,
3.2 [0.126] Max. panel thickness

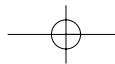
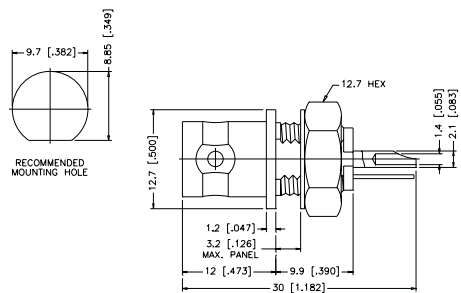

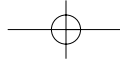

BULKHEAD RECEPTACLE/SOLDER POT TERMINALS

For Cable Group Legend, see page 69

BULKHEAD RECEPTACLE ISOLATED JACK — REAR MOUNT

P.N.	Cable Group	Finish	Insulation	Impedance	Crimp Tool
112624	N/A	Nickel	Teflon	50	N/A

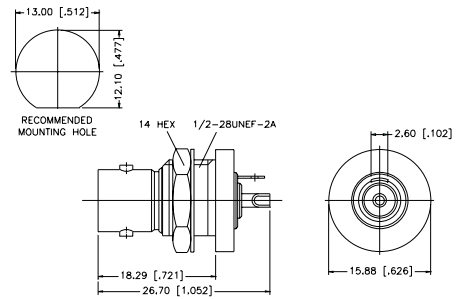

BULKHEAD RECEPTACLE — PRESS FIT

P.N.	Cable Group	Finish	Insulation	Impedance	Crimp Tool
112579	N/A	Nickel	Teflon	50	N/A

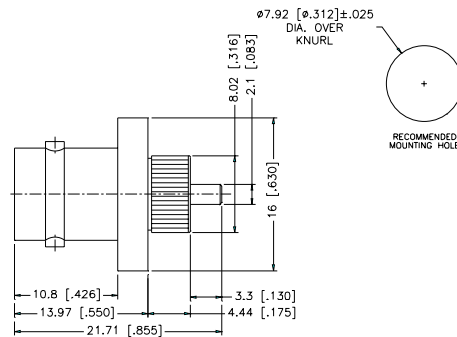

BULKHEAD RECEPTACLE — PRESS FIT

P.N.	Cable Group	Finish	Insulation	Impedance	Crimp Tool
112607	N/A	Nickel	Teflon	50	N/A

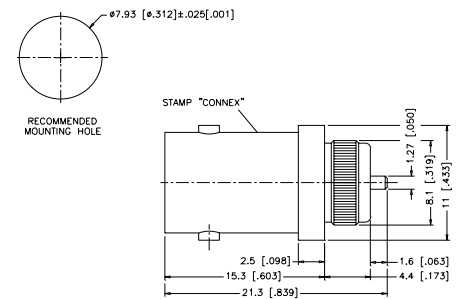

For Reverse Polarized connectors, add RP to standard part number. Contact Connex marketing for availability.
For Crimp Tool information, see page 183.

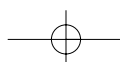

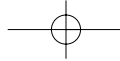

PANEL RECEPTACLES

For Cable Group Legend, see page 69

PANEL RECEPTACLE JACK

P.N.	Cable Group	Finish	Insulation	Impedance	Crimp Tool
112290	N/A	Nickel	Teflon	50	N/A
112291	N/A	Nickel	Teflon	75	N/A
112492	N/A	Nickel	Teflon	50	N/A
FLUSH REAR					
112511	N/A	Nickel	Teflon	50	N/A
FLUSH REAR 4-40 SCREWS					

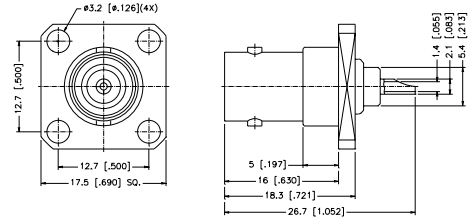

PANEL RECEPTACLE PLUG

P.N.	Cable Group	Finish	Insulation	Impedance	Crimp Tool
112653	N/A	Nickel	Teflon	50	A

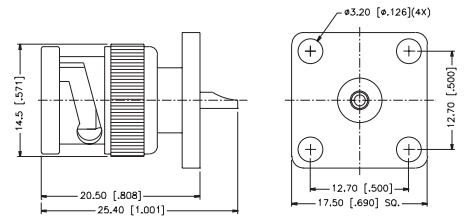

PANEL RECEPTACLE JACK — EXPOSED TFE TYPE

P.N.	Cable Group	Finish	Insulation	Impedance	Crimp Tool
112524N	N/A	Nickel	Teflon	50	N/A
112524S	N/A	Silver	Teflon	50	N/A

NOTE: Consult factory for other lengths available

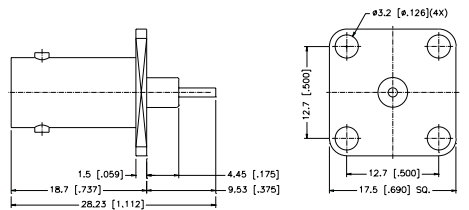

PANEL RECEPTACLE — EXPOSED TEFLON — GASKET SEAL

P.N.	Cable Group	Finish	Insulation	Impedance	Crimp Tool
112639	N/A	Nickel	Teflon	50	N/A

Note: Consult factory for other lengths available.

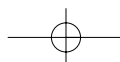
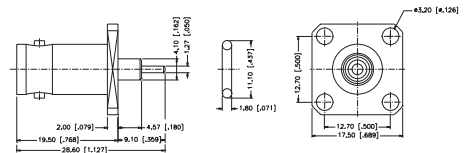

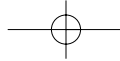

PRINTED CIRCUIT BOARD/RECEPTACLES

For Cable Group Legend, see page 69

STRAIGHT PCB MOUNT JACK

P.N.	Cable Group	Finish	Insulation	Impedance	Crimp Tool
112404	N/A	Nickel	Teflon	50	N/A
112405	N/A	Nickel	Teflon	75	N/A

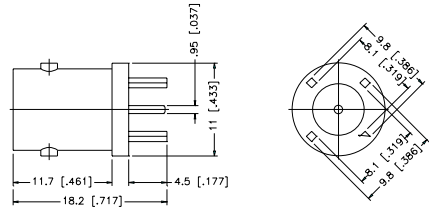

Mounting Hole Dia. see "TYPE C" page 185

STRAIGHT PCB MOUNT JACK

P.N.	Cable Group	Finish	Insulation	Impedance	Crimp Tool
112538	N/A	Nickel	Teflon	50	N/A
112543	N/A	Nickel	Teflon	75	N/A

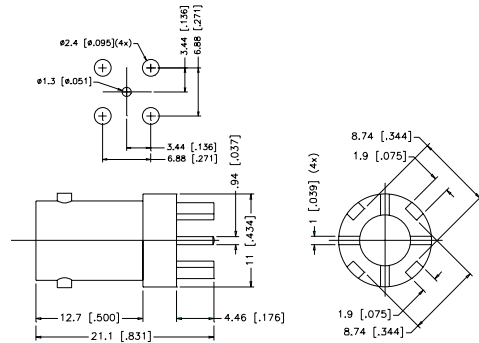

STRAIGHT PCB MOUNT JACK

P.N.	Cable Group	Finish	Insulation	Impedance	Crimp Tool
112515	N/A	Nickel	Teflon	50	N/A
112591	N/A	Nickel	Teflon	50	N/A

WATERPROOF

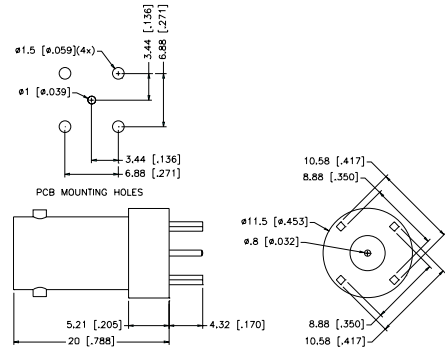

STRAIGHT PCB MOUNT JACK

P.N.	Cable Group	Finish	Insulation	Impedance	Crimp Tool
112553	N/A	Nickel	Teflon	50	N/A
112553-10	N/A	Nickel	Teflon	75	N/A

WATERPROOF

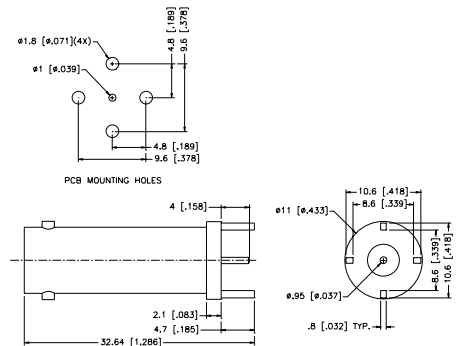

For Reverse Polarized connectors, add RP to standard part number. Contact Connex marketing for availability.
For Crimp Tool information, see page 183.

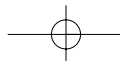

PRINTED CIRCUIT BOARD/RECEPTACLES

For Cable Group Legend, see page 69

STRAIGHT PCB MOUNT JACK — THREE LEGS

P.N.	Cable Group	Finish	Insulation	Impedance	Crimp Tool
112483	N/A 3 LEGS	Nickel	Teflon	50	N/A

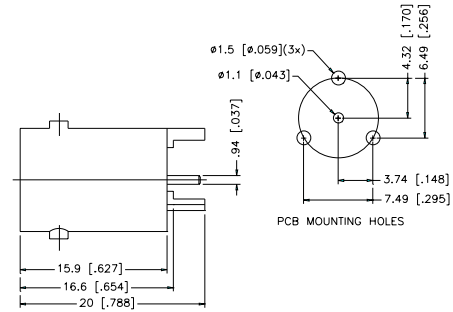

STRAIGHT PCB MOUNT JACK

P.N.	Cable Group	Finish	Insulation	Impedance	Crimp Tool
112586	N/A	Nickel	Teflon	75	N/A

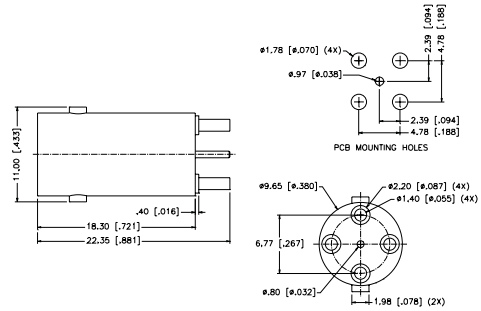

STRAIGHT PCB MOUNT JACK

P.N.	Cable Group	Finish	Insulation	Impedance	Crimp Tool
112406	N/A	Nickel	Teflon	50	N/A
112407	N/A	Nickel	Teflon	75	N/A

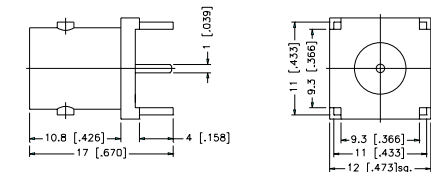

Mounting Hole Dia. see "TYPE F" page 185

STRAIGHT PCB MOUNT JACK

P.N.	Cable Group	Finish	Insulation	Impedance	Crimp Tool
112536	N/A	Nickel	Teflon	50	N/A
112578	N/A	Nickel	Teflon	75	N/A

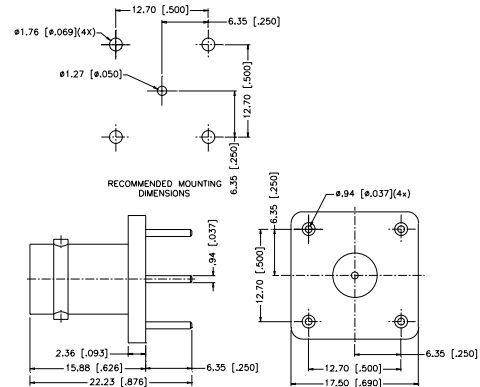

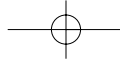

PRINTED CIRCUIT BOARD/RECEPTACLES

For Cable Group Legend, see page 69

STRAIGHT PCB EDGE MOUNT JACK — END LAUNCH

P.N.	Cable Group	Finish	Insulation	Impedance	Crimp Tool
112608	N/A	Nickel	Teflon	50	N/A
112622	N/A	Nickel	Teflon	75	N/A
SQUARE FLANGE					

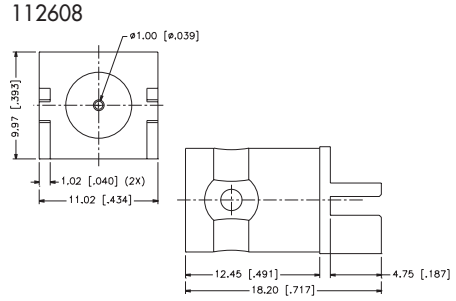

112640	N/A	Nickel	Teflon	50	N/A
112641	N/A	Nickel	Teflon	75	N/A
ROUND FLANGE					

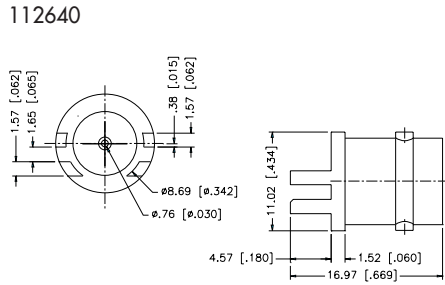

BULKHEAD VERTICAL PCB RECEPTACLE — END LAUNCH

P.N.	Cable Group	Finish	Insulation	Impedance	Crimp Tool
112633	N/A	Nickel	Teflon	50	N/A

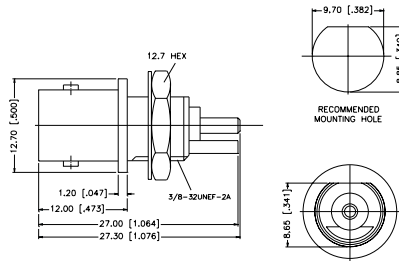

COMMERCIAL STRAIGHT PCB MOUNT JACK

P.N.	Cable Group	Finish	Insulation	Impedance	Crimp Tool
White Housing					
112408	N/A	Nickel	Polypropylene	50	N/A
112409	N/A	Nickel	Polypropylene	75	N/A
Black Housing					
112410	N/A	Nickel	Polypropylene	50	N/A
112411	N/A	Nickel	Polypropylene	75	N/A

Remark: Add L to part number for Locking Legs

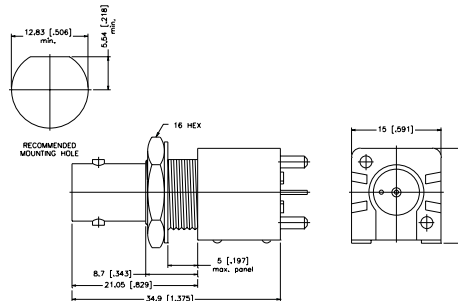

Mounting Hole Dia. see "TYPE G" page 185

For Reverse Polarized connectors, add RP to standard part number. Contact Connex marketing for availability.
For Crimp Tool information, see page 183.

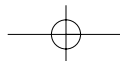

PRINTED CIRCUIT BOARD/RECEPTACLES

For Cable Group Legend, see page 69

COMMERCIAL STRAIGHT PCB MOUNT JACK — METAL BODY

P.N.	Cable Group	Finish	Insulation	Impedance	Crimp Tool
Diecast					
112488	N/A	Nickel	Polypropylene	50	N/A
112495	N/A	Nickel	Polypropylene	75	N/A

Note: Connectors are shipped with lock nut and washer

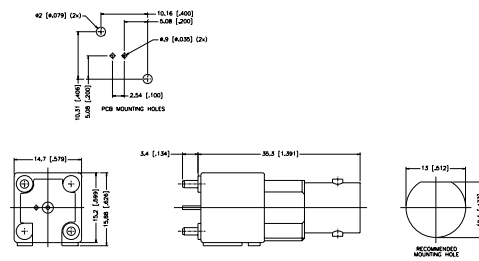
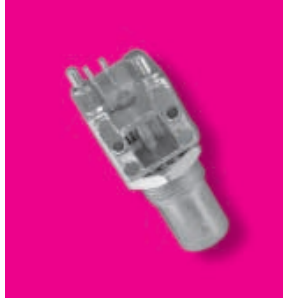

Mounting Hole Dia. see "TYPE G" page 185

COMMERCIAL RIGHT ANGLE PCB MOUNT JACK

P.N.	Cable Group	Finish	Insulation	Impedance	Crimp Tool
High Profile, 15.88 [.625] White					
112412	N/A	Nickel	Polypropylene	50	N/A
112413	N/A	Nickel	Polypropylene	75	N/A
High profile, 15.88 [.625] Black					
112414	N/A	Nickel	Polypropylene	50	N/A
112415	N/A	Nickel	Polypropylene	75	N/A
Low Profile, 13.1 [.516] White					
112416	N/A	Nickel	Polypropylene	50	N/A
112417	N/A	Nickel	Polypropylene	75	N/A
Low Profile, 13.1 [.516] Black					
112418	N/A	Nickel	Polypropylene	50	N/A
112419	N/A	Nickel	Polypropylene	75	N/A

Remark: Add L to part number for Locking Legs
Note: Connectors are shipped with lock nut and washer

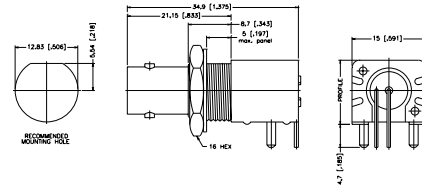

Mounting Hole Dia. see "TYPE H" page 185

COMMERCIAL RIGHT ANGLE PCB MOUNT JACK — METAL BODY

P.N.	Cable Group	Finish	Insulation	Impedance	Crimp Tool
Diecast					
High Profile, 15.88 [.625]					
112502	N/A	Nickel	Polypropylene	50	N/A
112503	N/A	Nickel	Polypropylene	75	N/A
Low Profile, 13.1 [.516]					
112487	N/A	Nickel	Polypropylene	50	N/A
112494	N/A	Nickel	Polypropylene	75	N/A

Note: Connectors are shipped with lock nut and washer

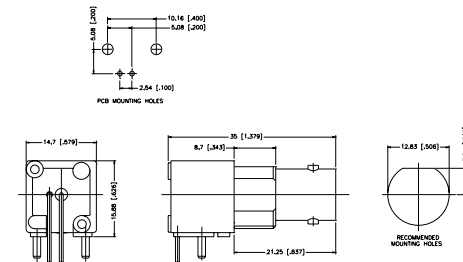

Mounting Hole Dia. see "TYPE H" page 185

RIGHT ANGLE PCB MOUNT RECEPTACLE — METAL BODY

P.N.	Cable Group	Finish	Insulation	Impedance	Crimp Tool
112659	N/A	Nickel	Teflon	50	N/A

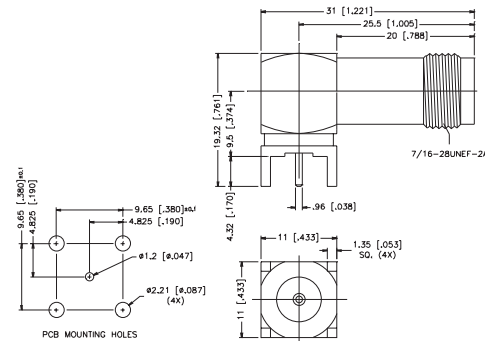

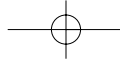

BULKHEAD FEEDTHROUGH ADAPTERS

For Cable Group Legend, see page 69

JACK-TO-JACK BULKHEAD ADAPTER

P.N.	Cable Group	Finish	Insulation	Impedance	Crimp Tool
112433	N/A	Nickel	Delrin	50	N/A
112434	N/A	Nickel	Delrin	75	N/A

Remark: 8.0 mm [.315] Max. panel thickness, M55339/13-00492

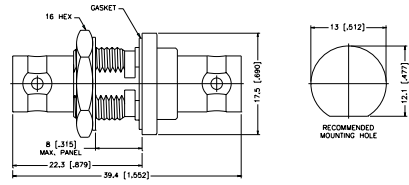

JACK-TO-JACK BULKHEAD ADAPTER

P.N.	Cable Group	Finish	Insulation	Impedance	Crimp Tool
112435	N/A	Nickel	Delrin	50	N/A
112436	N/A	Nickel	Delrin	75	N/A

Remark: 7.0 mm [.276] Max. panel thickness, UG-492A

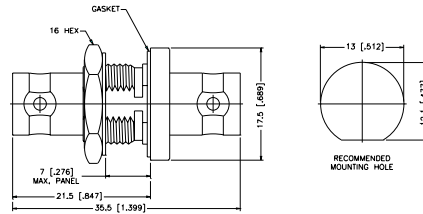

JACK-TO-JACK BULKHEAD ADAPTER

P.N.	Cable Group	Finish	Insulation	Impedance	Crimp Tool
112437	N/A	Nickel	Delrin	50	N/A
112438	N/A	Nickel	Delrin	75	N/A

Remark: Without gasket, 5.5 mm [.217] Max. panel thickness

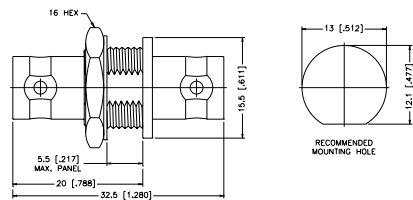

JACK-TO-PLUG BULKHEAD ADAPTER — PUSH-ON

P.N.	Cable Group	Finish	Insulation	Impedance	Crimp Tool
112532	N/A	Nickel	Teflon	75	N/A

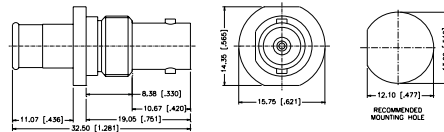

For Reverse Polarized connectors, add RP to standard part number. Contact Connex marketing for availability. For Crimp Tool information, see page 183.

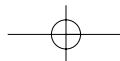

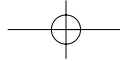

BULKHEAD ISOLATED GROUND ADAPTERS

For Cable Group Legend, see page 69

JACK-TO-JACK BULKHEAD — ISOLATED ADAPTER

P.N.	Cable Group	Finish	Insulation	Impedance	Crimp Tool
112439	N/A	Nickel	Delrin	50	N/A
112440	N/A	Nickel	Delrin	75	N/A

Remark: With Isolated Bushing,
4.5 mm [.177] Max. panel thickness

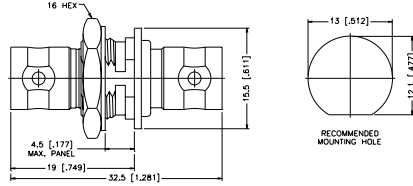

JACK-TO-JACK BULKHEAD — ISOLATED ADAPTER

P.N.	Cable Group	Finish	Insulation	Impedance	Crimp Tool
112443	N/A	Nickel	Delrin	50	N/A
112444	N/A	Nickel	Delrin	75	N/A

Remark: Isolated from ground,
5.5 mm [.217] Max. panel thickness

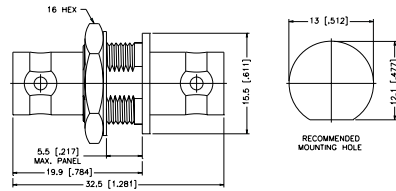

DUAL PORT RIGHT ANGLE PCB MOUNT RECEPTACLE

P.N.	Cable Group	Finish	Insulation	Impedance	Crimp Tool
WHITE HOUSING					
112660	N/A	Nickel	Polypropylene	50	N/A
BLACK HOUSING					
112661	N/A	Nickel	Polypropylene	50	N/A

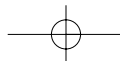
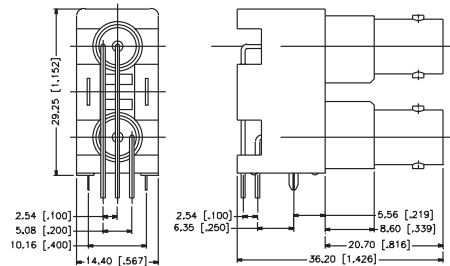

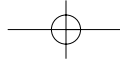

ADAPTERS

For Cable Group Legend, see page 69

JACK-TO-JACK ADAPTER

P.N.	Cable Group	Finish	Insulation	Impedance	Crimp Tool
112445	N/A	Nickel	Delrin	50	N/A
112446	N/A	Nickel	Delrin	75	N/A

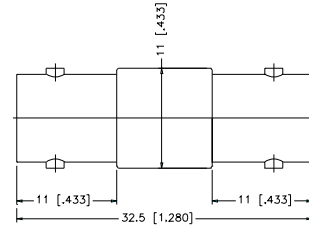

PLUG-TO-PLUG ADAPTER

P.N.	Cable Group	Finish	Insulation	Impedance	Crimp Tool
Brass Shell					
112447	N/A	Nickel	Delrin	50	N/A
112448	N/A	Nickel	Delrin	75	N/A
Diecast Shell					
112449	N/A	Nickel	Delrin	50	N/A
112450	N/A	Nickel	Delrin	75	N/A

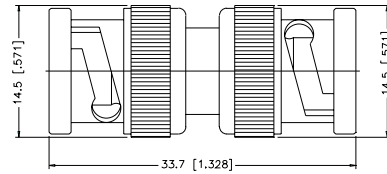

RIGHT ANGLE ADAPTER — PLUG-TO-JACK

P.N.	Cable Group	Finish	Insulation	Impedance	Crimp Tool
Brass Shell					
112451	N/A	Nickel	Delrin	50	N/A
112452	N/A	Nickel	Delrin	75	N/A
Diecast Shell					
112453	N/A	Nickel	Delrin	50	N/A
112454	N/A	Nickel	Delrin	75	N/A

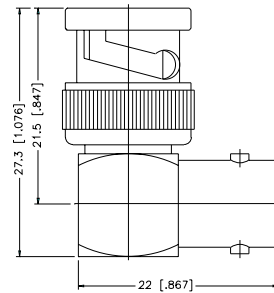

RIGHT ANGLE ADAPTER — PLUG-TO-PLUG

P.N.	Cable Group	Finish	Insulation	Impedance	Crimp Tool
112655	N/A	Nickel	Delrin	50	N/A

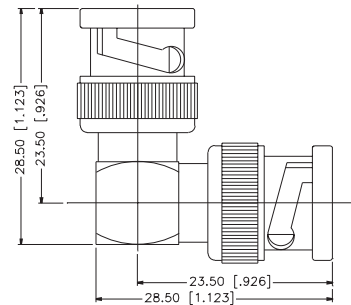

For Reverse Polarized connectors, add RP to standard part number. Contact Connex marketing for availability.
For Crimp Tool information, see page 183.

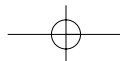

TEE ADAPTERS

For Cable Group Legend, see page 69

TEE ADAPTER — JACK-TO-JACK-TO-JACK

P.N.	Cable Group	Finish	Insulation	Impedance	Crimp Tool
112455	N/A	Nickel	Delrin	50	N/A
112456	N/A	Nickel	Delrin	75	N/A

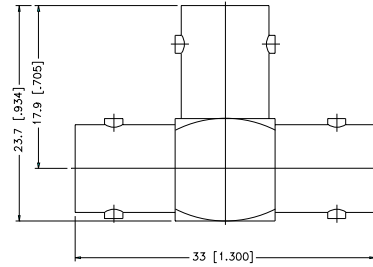

TEE ADAPTER — JACK-TO-PLUG-TO-JACK

P.N.	Cable Group	Finish	Insulation	Impedance	Crimp Tool
112461	N/A	Nickel	Delrin	50	N/A
112462	N/A	Nickel	Delrin	75	N/A

Remark: Diecast Version
Remark: TEE contact pin isolated completely

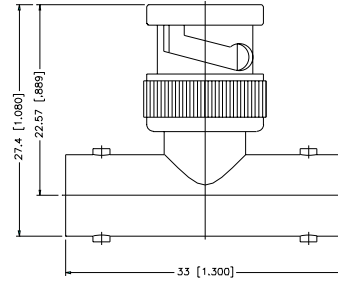

TEE ADAPTER — JACK-TO-JACK-TO-PLUG

P.N.	Cable Group	Finish	Insulation	Impedance	Crimp Tool
112567	N/A	Nickel	Delrin	50	N/A
112590	N/A	Nickel	Teflon	50	N/A

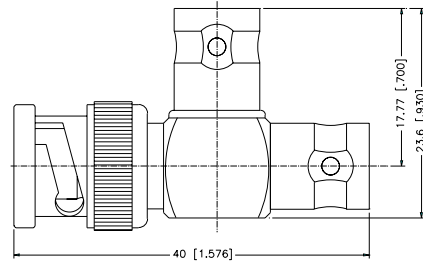

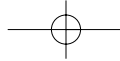

TERMINATORS

For Cable Group Legend, see page 69

BNC TERMINATOR PLUG

P.N.	Cable Group	Finish	Insulation	Impedance	Crimp Tool
202103	N/A	Nickel	Delrin	50	N/A
202104	N/A	Nickel	Teflon	50	N/A
202105	N/A	Nickel	Delrin	75	N/A
202106	N/A	Nickel	Teflon	75	N/A
202107	N/A	Nickel	Delrin	93	N/A
202108	N/A	Nickel	Teflon	93	N/A
202113	N/A	Nickel	Teflon	50	N/A
HIGH PERFORMANCE					
202119	N/A	Nickel	Teflon	75	N/A
HIGH PERFORMANCE					

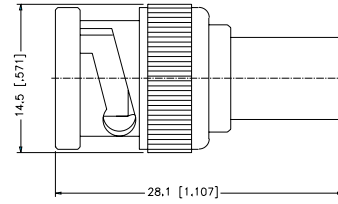
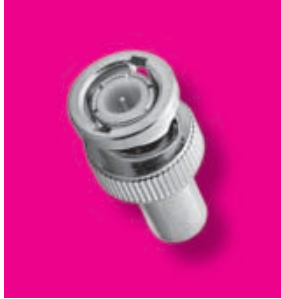

BNC TERMINATOR JACK

P.N.	Cable Group	Finish	Insulation	Impedance	Crimp Tool
202120	N/A	Nickel	Delrin	50	N/A
202111	N/A	Nickel	Delrin	75	N/A
112504	N/A	Nickel	Delrin	500	N/A

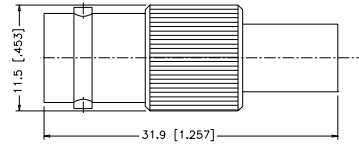

For Reverse Polarized connectors, add RP to standard part number. Contact Connex marketing for availability.
For Crimp Tool information, see page 183.

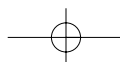

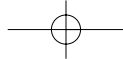

ACCESSORIES

For Cable Group Legend, see page 69

BNC MALE CAP & CHAIN

P.N.	Cable Group	Finish	Insulation	Impedance	Crimp Tool
202100	N/A	Nickel	N/A	N/A	N/A
Remark: Chain Length 100 mm					
202100-10	N/A	Nickel	N/A	N/A	N/A
LESS CHAIN					

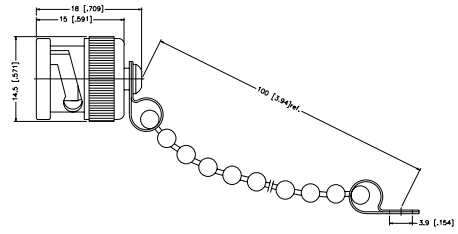

BNC MALE SHORTING CAP

P.N.	Cable Group	Finish	Insulation	Impedance	Crimp Tool
202114	N/A	Nickel	Teflon	N/A	N/A
LESS CHAIN					
202115	N/A	Nickel	Teflon	N/A	N/A
WITH CHAIN					

