

THIS INFORMATION IS CONFIDENTIAL AND IS DISCLOSED TO YOU ON CONDITION THAT NO FURTHER DISCLOSURE IS MADE BY YOU TO OTHER THAN AMP PERSONNEL WITHOUT WRITTEN AUTHORIZATION FROM AMP (TAWAN) LTD. DIMENSIONS IN MILLIMETERS. DO NOT SCALE PRINT.

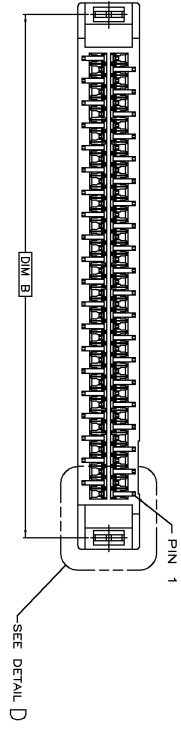
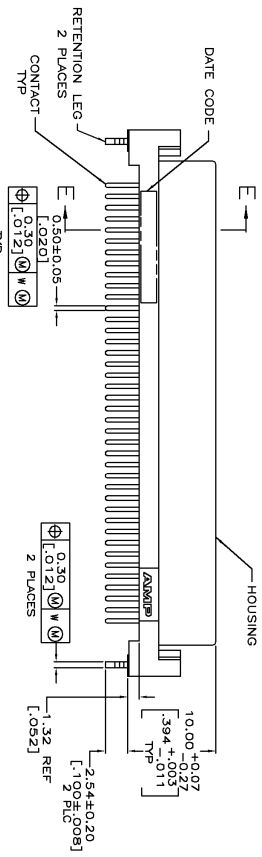
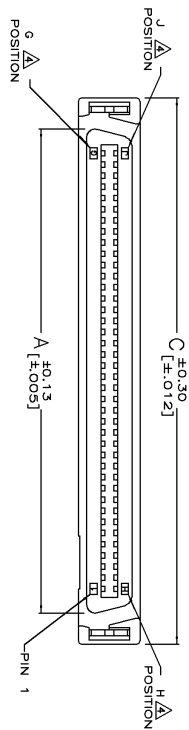
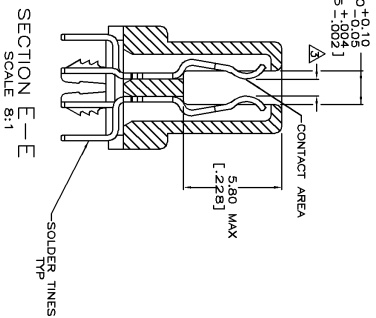
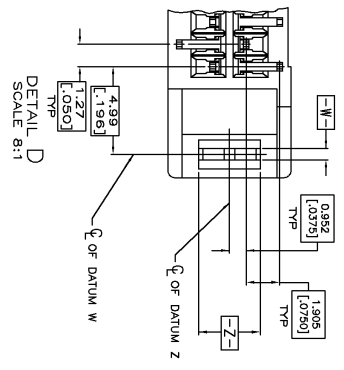

- ▲ HOUSING: PPA RESIN, BLACK.
- ▲ CONTACTS: PHOSPHOR BRONZE.
- ▲ RETENTION LEG: BRASS.
- 2. CONNECTOR WILL ACCOMMODATE PRINTED CIRCUIT BOARD THICKNESS OF 0.79 TO 1.60 [0.31 TO 0.63].
- ▲ CONNECTOR WILL ACCOMMODATE MATING PRINTED CIRCUIT BOARD OF 1.60±0.08 [0.63±0.03] THICKNESS.
- ▲ SEE TABLE G, J, AND H INDICATE NUMBER OF POSITIONS MARKED ON ASSEMBLY.
- ▲ CONTACTS: 0.276mm [0.00030] MIN GOLD PLATING ON CONTACT AREA.
- ▲ 3.81mm [0.00150] MIN MATTE TIN PLATING ON SOLDER TAILS.
- ▲ 1.27mm [0.00050] MIN NICKEL UNDERPLATING OVERALL.
- ▲ RETENTION LEG: 3.81mm [0.00150] MIN MATTE TIN OVER 1.27mm [0.00050] MIN NICKEL.
- 7 WAVE SOLDER CAPABLE TO 285°C PER TPO SPEC 109-202, CONDITION B.

J	A	H	G	A	B	A	FINISH	POSITION	PART NUMBER
130	66	65	93.90 [3.697]	91.26 [3.593]	86.82 [3.418]	▲	130	3-1734331-3	
80	41	41	62.22 [2.450]	59.51 [2.343]	55.07 [2.168]	▲	80	2-1734331-1	
68	35	35	54.57 [2.148]	51.89 [2.043]	47.45 [1.868]	▲	68	1-1734331-7	
50	26	25	43.10 [1.697]	40.46 [1.593]	36.02 [1.418]	▲	50	1734331-9	

TOLERANCES UNLESS OTHERWISE SPECIFIED:
 0. PLC ±
 2. PLC ±
 3. PLC ±
 ANGLES ±.5°

APVD	W.L. KE	06-JUN-2006	NAME	tyco	TYCO HOLDINGS (BERMUDA)
PRODUCT SPEC	108-1367	06-JUN-2006	CHK	S. HOU	VII LTD. TAIWAN BRANCH
APPLICATION SPEC	114-6045	10JUN 2006	DATE	DWM/GMK	
FINISH	▲▲▲				

RECEPTACLE ASSEMBLY, V/T
 BOARD-TO-BOARD,
 .050 SERIES I, CHAMP*

LOC	SIZE	DRAWING NO.	REV
DW	A3	C-1734331	A
SCALE	--	SHEET	1 OF 2

OH	10JUN 2006	DATE
SH	2006	DATE
DMV	G/MK	DATE
EN		
REVISION RECORD		
FIRST RELEASED		
A		
LTR		

8 7 6 5 4 3 2 1 CUSTOMER DRAWING

THIS INFORMATION IS CONFIDENTIAL AND IS DISCLOSED TO YOU ON CONDITION THAT NO FURTHER DISCLOSURE IS MADE BY YOU TO OTHER THAN AMP PERSONNEL WITHOUT WRITTEN AUTHORIZATION FROM AMP (TAIWAN) LTD. DIMENSIONS IN MILLIMETERS. DO NOT SCALE PRINT.

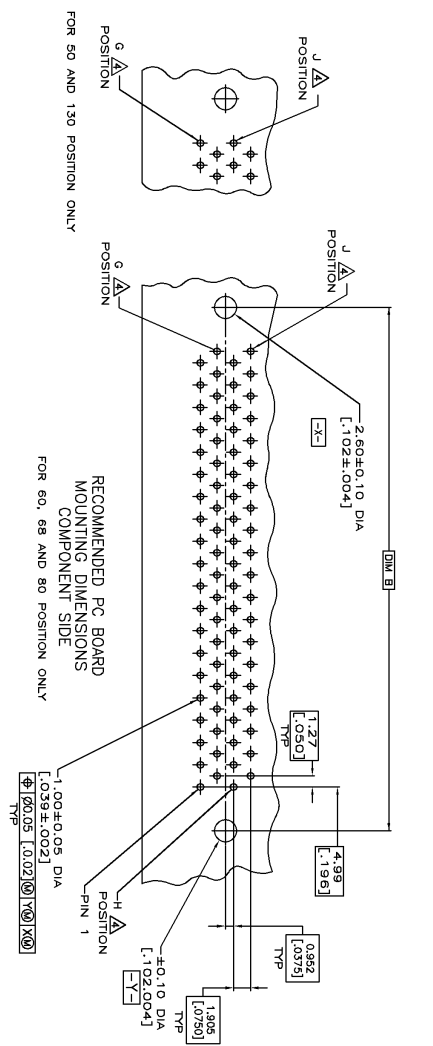

FOR 80 AND 130 POSITION ONLY

RECOMMENDED PC BOARD MOUNTING DIMENSIONS COMPONENT SIDE

FOR 60, 68 AND 80 POSITION ONLY

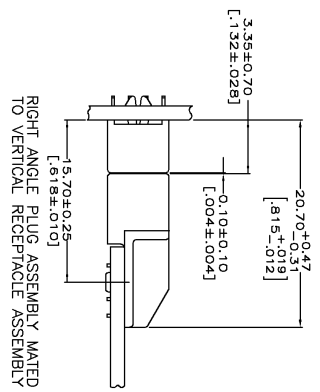

RIGHT ANGLE PLUG ASSEMBLY MATED TO VERTICAL RECEPTACLE ASSEMBLY

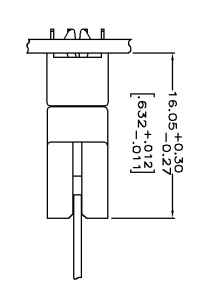

VERTICAL RECEPTACLE ASSEMBLY MATED TO VERTICAL PLUG STRADDLE ASSEMBLY

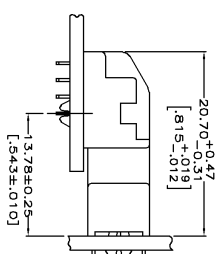

VERTICAL RECEPTACLE ASSEMBLY MATED TO RIGHT ANGLE PLUG ASSEMBLY

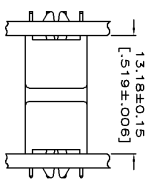

VERTICAL RECEPTACLE ASSEMBLY MATED TO VERTICAL PLUG ASSEMBLY

TOLERANCES UNLESS OTHERWISE SPECIFIED:		DWN	O. HU
0	PLC ±	06-JUN-2006	06-JUN-2006
1	PLC ±	S. HOU	
2	PLC ±		
3	PLC ±		
ANGLES : ± .			
MATERIAL		APVD	W.L. KE
SEE NOTE		PRODUCT SPEC	06-JUN-2006
FINISH		APPLICATION SPEC	
SEE NOTE		WEIGHT	
LOC		SCALE	REV
DW	A3	C-1734331	A
SHEET		2 OF 2	

tyco
Electronics
TYCO HOLDINGS (BERMUDA)
VII LTD. TAIWAN BRANCH

RECEPTACLE ASSEMBLY, V/T
BOARD-TO-BOARD,
.050 SERIES I, CHAMP*

LTR	REVISION RECORD	ECN	DWG/CHK	DATE
	SEE SHEET 1.			