

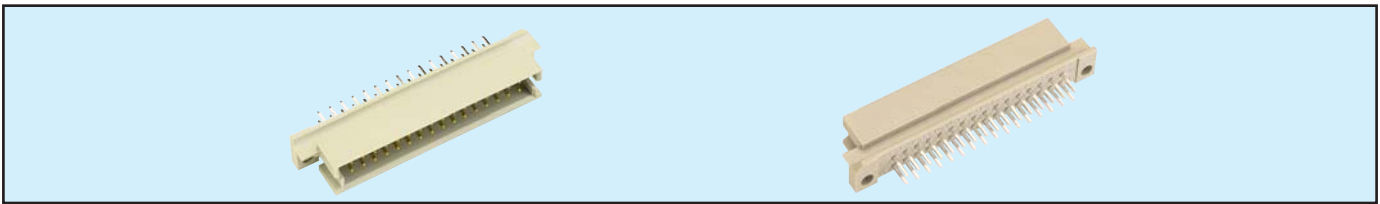





Male Style 1/2 Q



Series 8477 – 2 rows (2 x 16) Inverted



Contact Design and Termination Length	Number of Contacts	Loading Description	Part Number Performance classes according to DIN 41612	
			II	I
2.9 mm (Y) Straight 	32	a + b fully loaded	10 8477 032 001 025	10 8477 032 001 049
	16	a + b even loading	10 8477 032 001 031	10 8477 032 001 055
	16	a loading only	10 8477 032 001 027	10 8477 032 001 051
	30 + 2	fully loaded + ground	10 8477 032 101 025	10 8477 032 101 049
4.5 mm (Y) Straight 	32	a + b fully loaded	10 8477 032 002 025	10 8477 032 002 049
	16	a + b even loading	10 8477 032 002 031	10 8477 032 002 055
	16	a loading only	10 8477 032 002 027	10 8477 032 002 051
	30 + 2	fully loaded + ground	10 8477 032 102 025	10 8477 032 102 049
9.5 mm (Y) Straight 	32	a + b fully loaded	10 8477 032 005 025	10 8477 032 005 049
	16	a + b even loading	10 8477 032 005 031	10 8477 032 005 055
	16	a loading only	10 8477 032 005 027	10 8477 032 005 051
13.0 mm (Y) Straight 	32	a + b fully loaded	10 8477 032 006 025	10 8477 032 006 049
	16	a + b even loading	10 8477 032 006 031	10 8477 032 006 055
	16	a loading only	10 8477 032 006 027	10 8477 032 006 051
14.9 mm (Y) Straight 	32	a + b fully loaded	10 8477 032 007 025	10 8477 032 007 049
	16	a + b even loading	10 8477 032 007 031	10 8477 032 007 055
	16	a loading only	10 8477 032 007 027	10 8477 032 007 051

NB: Alternative Prefix Variations Available: 12, 14, 15, 16 & 17, please refer to Page 10.

Additional Plating & Loading Variations: Please contact your local AVX sales office or distributor.

LOADING DESCRIPTION

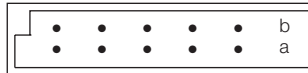

32 contacts, rows a + b fully loaded

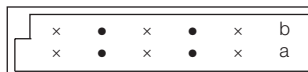

16 contacts, rows a + b even loading

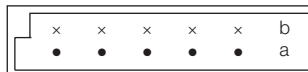

16 contacts, row a loading only

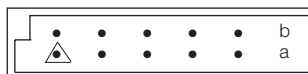

30 + 2 contacts, fully loaded with ground in A1 & A16

△ denotes ground pin

DIMENSIONS

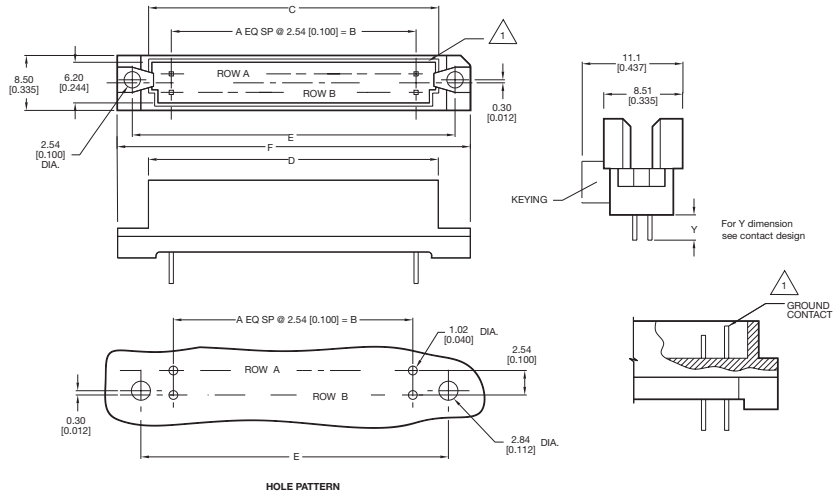

Unit: millimeters (inches)

No. Contact Positions	Contact Rows	A	B	C	D	E	F
32	2 (2 x 16)	15	38.10 (1.500)	44.70 (1.760)	47.29 (1.862)	49.99 (1.968)	54.91 (2.162)

Part Numbering Format

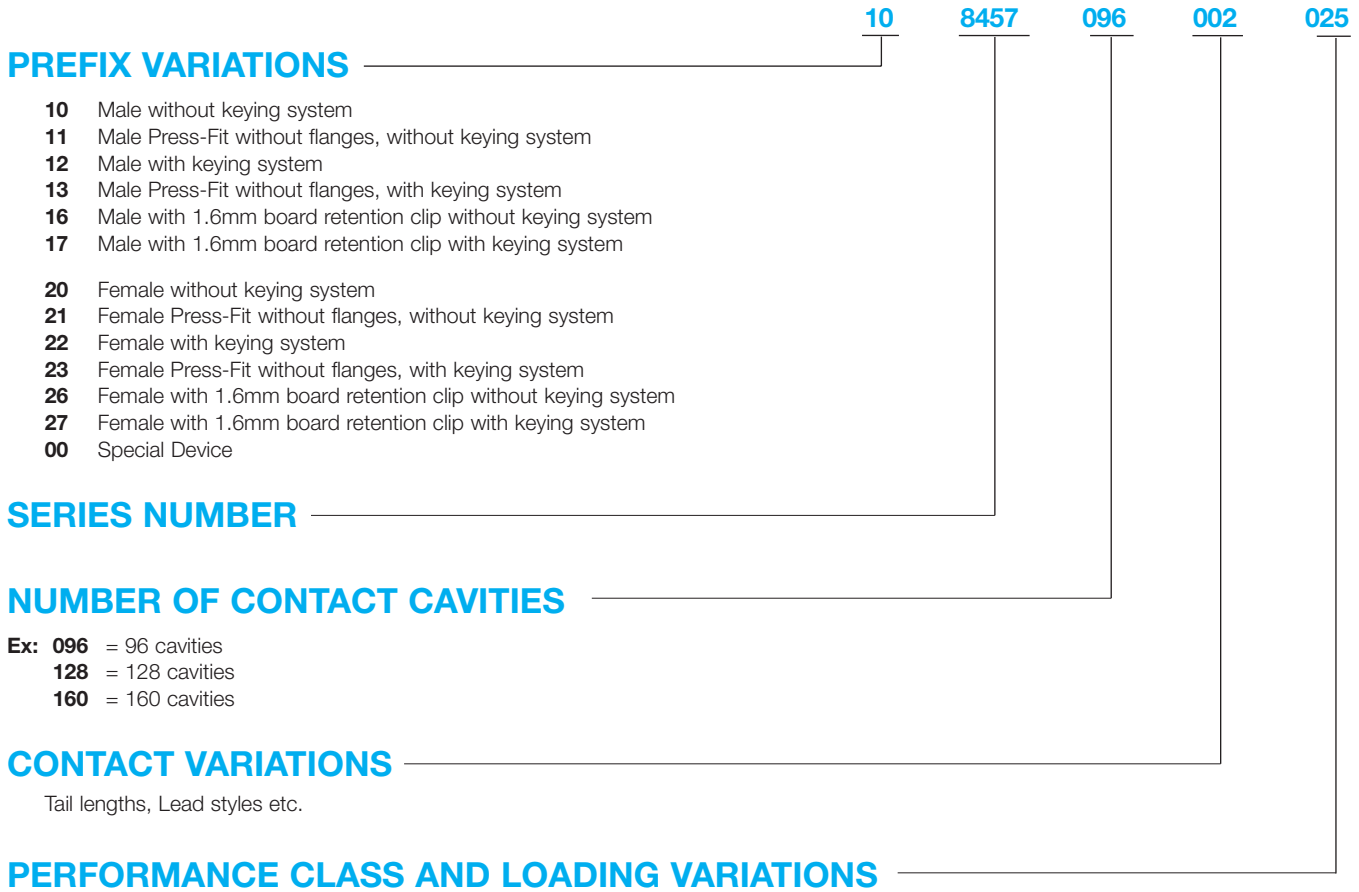

Class	M55302 Class I	DIN 41612 Class II	DIN 41612 Class III
Cycle Life	500+ Mating Cycles	400 Mating Cycles	50 Mating Cycles

QUALIFIED MILITARY PART NUMBERS

Military Designation	
M55302/131-01	M55302/134-02
M55302/131-02	M55302/134-04
M55302/132-01	M55302/134-05
M55302/132-02	M55302/134-07
M55302/132-03	M55302/134-08
M55302/132-04	M55302/157-01
M55302/132-05	M55302/157-02
M55302/132-06	M55302/157-03
M55302/133-01	M55302/157-04
M55302/133-02	M55302/158-01
M55302/133-03	M55302/158-02
M55302/134-01	

Technical Specifications



inches (mm)

SERIES 8254/8459 8457/8458 8477/8478 8483/8484	Basic Grid	0.100 (2.54) x 0.100 (2.54) - 0.100 (2.54) x 0.200 (5.08)	
	Insertion Force	3.0 oz./0.83 N average per contact pair (20.23/90N max. for 96 contacts)	
	Withdrawal Force	Average per contact pair (.54 oz./0.15N min. per contact)	
	Contact Positions	2 x 16, 2 x 32, 3 x 10, 3 x 16, 3 x 32, 3 x 50, 4 x 32, 4 x 50, 5 x 32	
	Contact Resistance	20 milliohms max.	
	Current Rating* (see note)	3 amperes @ 20°C max. on connectors up to 96 contacts 1 ampere max. on connectors from 100 to 201 contacts	
	Insulation Resistance	5,000 megohms min. at 500 VDC	
	Dielectric Withstanding	1,000 VAC rms at sea level	
	Operating Temperature	-65°C to +125°C	
	Insulator Material	Thermoplastic polyester (GF), 94 V-O, UL rated	
	Socket Contact Material	Phosphor bronze	
	Pin Contact Material	Copper tin	
	Wrap Post Dimension	0.024 x 0.024 (0.6 mm x 0.6 mm)	
	Push-Out Force of Post in Insulator	3 lbs.	
	Contact Plating	DIN performance classes	
	SERIES 8447	Basic Grid	0.200 (5.08) x 0.200 (5.08)
		Insertion Force	4.0 oz./1.11 N average per contact pair (9.0 lbs./40N max. for 32 contacts)
Withdrawal Force		Average per contact pair (.54 oz./0.15N min. per contact)	
Contact Positions		2 x 16, 3 x 16	
Contact Resistance		15 milliohms max.	
Current Rating* (see note)		5.5 amperes @ 20°C max.	
Insulation Resistance		5,000 megohms min. at 500 VDC	
Dielectric Withstanding		1,550 VAC rms at sea level	
Operating Temperature		-65°C to +125°C	
Insulator Material		Thermoplastic (GI), 94 V-O, UL Rated	
Pin Contact Material		Copper alloy	
Wrap Post Dimension		1.0 mm x 1.0 mm	
Contact Plating		DIN performance classes	
SERIES 8557/8577	Basic Grid	0.100 (2.54) x 0.100 (2.54) - 0.100 (2.54) x 0.200 (5.08)	
	Insertion Force	3.0 oz./0.83 N average per contact pair (20.23/90N max. for 96 contacts)	
	Withdrawal Force	Average per contact pair (.54 oz./0.15N min. per contact)	
	Contact Positions	3 x 16, 3 x 32, 4 x 32, (inverted receptacle)	
	Contact Resistance	20 milliohms max.	
	Current Rating* (see note)	3 amperes @ 20°C max. on connectors up to 96 contacts	
	Insulation Resistance	5,000 megohms min. at 500 VDC	
	Dielectric Withstanding	1,000 VAC rms at sea level	
	Operating Temperature	-65°C to +125°C	
	Insulator Material	Surface mount compatible polymers, 94 V-O, UL Rated	
	Socket Contact Material	Phosphor bronze	
	Pin Contact Material	Copper alloy	
	Wrap Post Dimension	0.024 x 0.024 (0.6 mm x 0.6 mm)	
	Push-Out Force of Post in Insulator	3 lbs.	
	Contact Plating	DIN performance classes	
	Solder Temperature	max. 250°C	

*Current Rating: UL approval allows that DIN connectors up to 96 contacts be rated at 3 amperes. Over 96 pins must be derated to 1.0 ampere maximum VDE, CSA, and other European standards rate all DIN and DIN type connectors at 1 ampere maximum when they are on an 0.100 (2.54) x 0.100 (2.54) grid. (UL file # E27610 Vol. #1 Section #6)

Technical Specifications



inches (mm)

SERIES 8449/8450 8456/8454 8487	Basic Grid	0.200 (5.08) x 0.200 (5.08)
	Insertion Force	4.0 oz./1.11 N average per contact pair (9.0 lbs./40N max. for 32 contacts)
	Withdrawal Force	Average per contact pair (.54 oz./0.15N min. per contact)
	Contact Positions	2 x 5 + 2, 3 x 16, 1 x 11, 1 x 7, 1 x 8
	Contact Resistance	15 milliohms max.
	Current Rating* (see note)	5.5 amperes @ 20°C max. (8456)
	Insulation Resistance	5,000 megohms min. at 500 VDC
	Dielectric Withstanding	1,550 VAC rms at sea level
	Operating Temperature	-65°C to +125°C
	Insulator Material	Polycarbonate (GF)
	Pin Contact Material	Copper alloy
	Wrap Post Dimension	N/A
	Contact Plating	DIN performance classes

*Current Rating: UL approval allows that DIN connectors up to 96 contacts be rated at 3 amperes. Over 96 pins must be derated to 1.0 ampere maximum VDE, CSA, and other European standards rate all DIN and DIN type connectors at 1 ampere maximum when they are on an 0.100 (2.54) x 0.100 (2.54) grid. (UL file # E27610 Vol. #1 Section #6)