

PLEASE CHECK WWW.MOLEX.COM FOR LATEST PART INFORMATION

Part Number: [15-31-1026](#)
Status: **Active**
Overview: Standard .093" Pin and Socket Connectors
Description: 2.36mm Diameter Standard .093" Pin and Socket Header, Vertical, with Beveled Plastic Peg, 2 Circuits

Documents:

3D Model	Test Summary TS-5219-002 (PDF)
Drawing (PDF)	RoHS Certificate of Compliance (PDF)
Product Specification PS-3191-003 (PDF)	

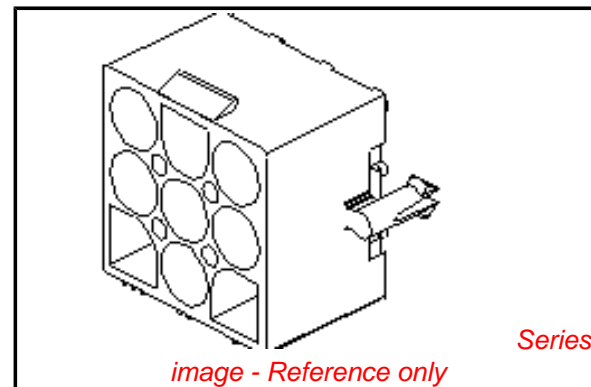

image - Reference only

Agency Certification

CSA	LR19980
UL	E29179

General

Product Family	PCB Headers
Series	5219
Application	Power, Wire-to-Board
Overview	Standard .093" Pin and Socket Connectors
Product Name	Standard .093"
UPC	800753604537

Physical

Breakaway	No
Circuits (Loaded)	2
Circuits (maximum)	2
Durability (mating cycles max)	30
First Mate / Last Break	No
Flammability	94V-2
Glow-Wire Compliant	No
Guide to Mating Part	No
Keying to Mating Part	None
Lock to Mating Part	Yes
Material - Plating Mating	Tin
Material - Plating Termination	Tin
Net Weight	2050.402/mg
Number of Rows	1
Orientation	Vertical
PCB Locator	Yes
PCB Retention	Yes
PCB Thickness - Recommended	1.60mm
Packaging Type	Bag
Pitch - Mating Interface	6.70mm
Polarized to PCB	Yes
Shrouded	Fully
Stackable	No
Surface Mount Compatible (SMC)	No
Temperature Range - Operating	-40°C to +105°C
Termination Interface: Style	Through Hole

Electrical

Current - Maximum per Contact	12A
Voltage - Maximum	600V

Material Info

Old Part Number	5219-02A
-----------------	----------

EU RoHS **China RoHS**

ELV and RoHS Compliant
REACH SVHC
Contains SVHC: No
Low-Halogen Status
Low-Halogen



Need more information on product environmental compliance?

Email productcompliance@molex.com
 For a multiple part number RoHS Certificate of Compliance, [click here](#)

Please visit the [Contact Us](#) section for any non-product compliance questions.

Search Parts in this Series

[5219Series](#)

Mates With

[3191 Pin and Socket Receptacle Housing](#)

Reference - Drawing Numbers

Product Specification

Sales Drawing

Test Summary

PS-3191-003, RPS-3191-002, RPS-3191-005

SD-5219-02A*-*

TS-5219-002

This document was generated on 01/26/2015

PLEASE CHECK WWW.MOLEX.COM FOR LATEST PART INFORMATION