

LOC	DIST	REVISIONS					
DW		P	LTR	DESCRIPTION	DATE	DWN	APVD
		F		REVISED PER ECR-14-013570	11SEP2014	D.S	F.Y

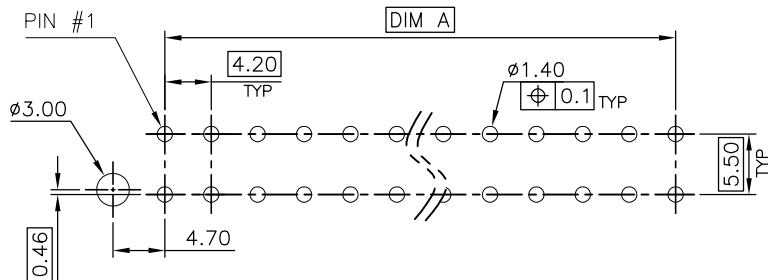

RECOMMENDED PCB LAYOUT
 TOLERANCE: ±0.05 T=1.6mm

- NOTE:
- MATERIAL:
 HOUSING: PA9T, UL94 V-0, COLOR: (SEE TABLE).
 CONTACTS: BRASS.
 - FINISH:
 CONTACTS: 3.05um [120u"] MIN. MATTE-TIN.
 1.27um [50u"] MIN. NICKEL UNDERPLATED ALL OVER.
 - WAVE SOLDER CAPABLE TO 265°C PER TEST SPEC.
 109-202, CONDITION B.
 - NO TE LOGO AND DATE CODE ON THE PRODUCT WITH 4 POS.
 - THE KEY IDENTIFIED WAS SHOWN ON PAGE 5.

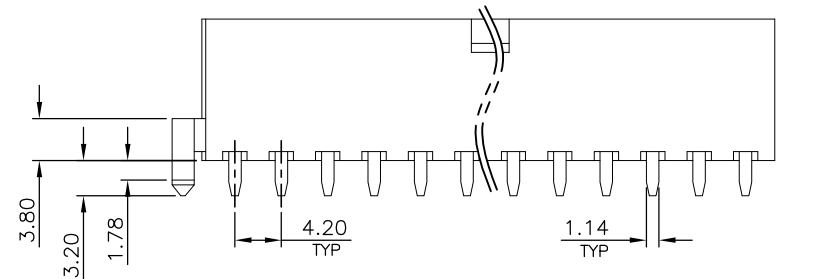
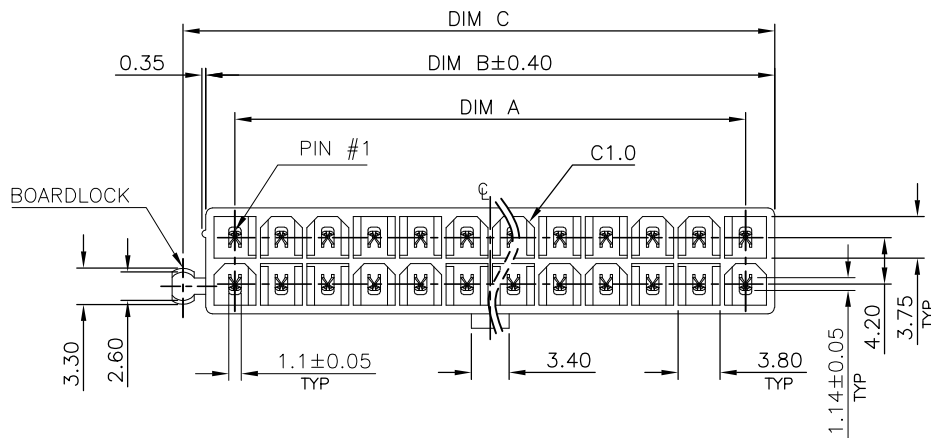
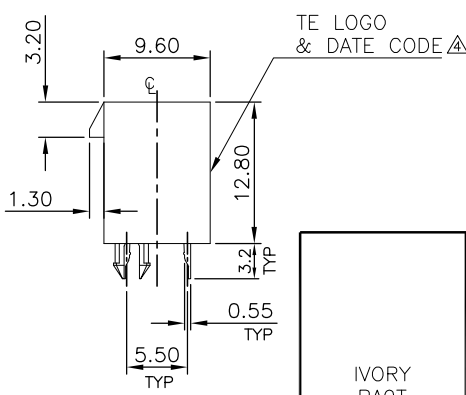

ONE BOARDLOCK
(LEFT)

IVORY PA9T	5.40	46.2	51.5	53.55	24	1-1775099-3
	1.13	4.2	9.5	11.55	4	1-1775099-2
	4.30	37.8	43.1	45.15	20	1-1775099-1
	3.90	33.6	38.9	40.95	18	1-1775099-0
	3.11	25.2	30.5	32.55	14	1775099-9
	2.71	21.0	26.3	28.35	12	1775099-8
	2.31	16.8	22.1	24.15	10	1775099-7
	1.52	8.4	13.7	15.75	6	1775099-6
1.92	12.6	17.9	19.95	8	1775099-5	
IVORY PA9T	5.40	46.2	51.5	53.55	24	1775099-4
	1.13	4.2	9.5	11.55	4	1775099-3
TRANSPARENCE PA9T	5.40	46.2	51.5	53.55	24	1775099-2
	1.13	4.2	9.5	11.55	4	1775099-1
HSG COLOR & MATERIAL	WEIGHT	DIM A	DIM B	DIM C	POS.	PART NUMBER

SUPERSEDED TO 1-1775099-3
 SUPERSEDED TO 1-1775099-2

THIS DRAWING IS A CONTROLLED DOCUMENT.

DIMENSIONS: mm	TOLERANCES UNLESS OTHERWISE SPECIFIED: 0 PLC ± . 1 PLC ± 0.3 2 PLC ± 0.2 3 PLC ± 0.15 4 PLC ANGLES ± 3'	DWN B. HSING 15JUL2009 CHK S. CHIEN 15JUL2009 APVD W. KODAMA 15JUL2009	TE Connectivity
MATERIAL SEE NOTE	FINISH SEE NOTE	PRODUCT SPEC 108-57560 APPLICATION SPEC	NAME ATX POWER CONNECTOR 4.2mm PITCH, VERTICAL, DIP TYPE
		WEIGHT SEE TABLE	SIZE A3
		CUSTOMER DRAWING	CAGE CODE 00779
			DRAWING NO C=1775099
			RESTRICTED TO
			SCALE -
			SHEET 1 of 6
			REV F

THIS DRAWING IS UNPUBLISHED. RELEASED FOR PUBLICATION
 © COPYRIGHT 2010 BY TYCO ELECTRONICS CORPORATION. ALL RIGHTS RESERVED.

LOC	DIST	REVISIONS			
P	LTR	DESCRIPTION	DATE	DWN	APVD
		SEE SHEET 1.			

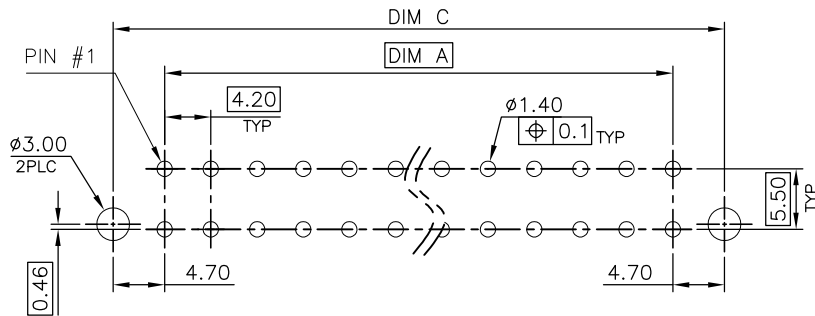
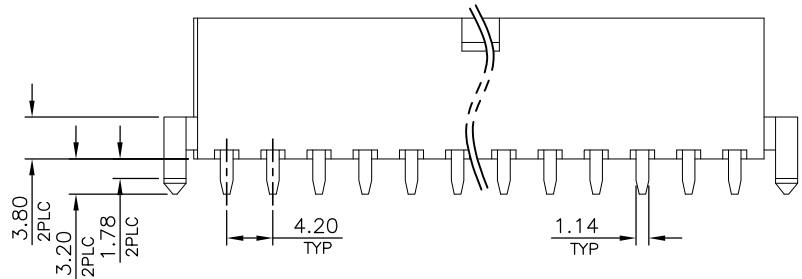
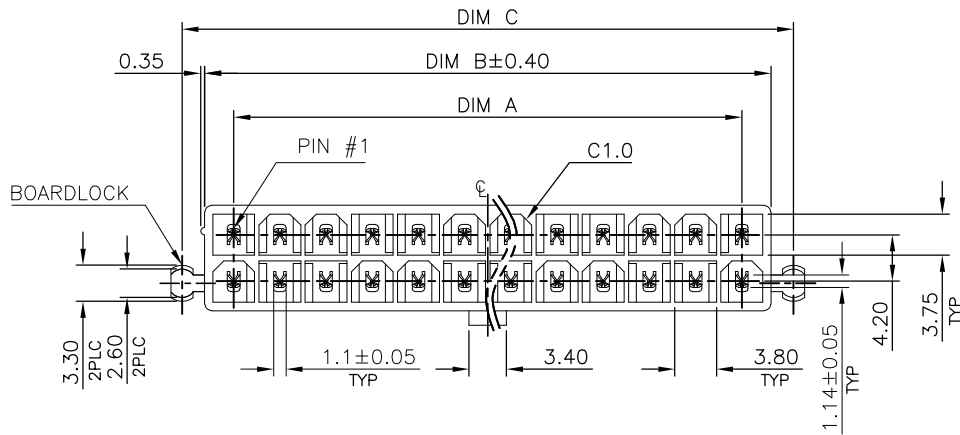

RECOMMENDED PCB LAYOUT
 TOLERANCE: ±0.05 T=1.6mm

- NOTE:
- MATERIAL:
HOUSING: PA9T, UL94 V-0, COLOR: (SEE TABLE).
CONTACTS: BRASS.
 - FINISH:
CONTACTS: 3.05um [120u"] MIN. MATTE-TIN.
1.27um [50u"] MIN. NICKEL UNDERPLATED ALL OVER.
 - WAVE SOLDER CAPABLE TO 265°C PER TEST SPEC.
109-202, CONDITION B.
 - NO TE LOGO AND DATE CODE ON THE PRODUCT WITH 4 POS.
 - THE KEY IDENTIFIED WAS SHOWN ON PAGE 5.

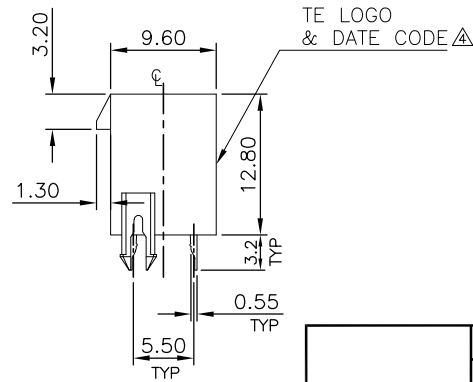

TWO BOARDLOCK

IVORY PA9T	3.54	29.4	34.7	38.8	16	2-1775099-9
	5.43	46.2	51.5	55.6	24	2-1775099-8
	4.33	37.8	43.1	47.2	20	2-1775099-7
	3.93	33.6	38.9	43.0	18	2-1775099-6
	3.14	25.2	30.5	34.6	14	2-1775099-5
	2.74	21.0	26.3	30.4	12	2-1775099-4
	2.34	16.8	22.1	26.2	10	2-1775099-3
	1.95	12.6	17.9	22.0	8	2-1775099-2
	1.55	8.4	13.7	17.8	6	2-1775099-1
	1.16	4.2	9.5	13.6	4	2-1775099-0
HSG COLOR & MATERIAL	WEIGHT	DIM A	DIM B	DIM C	POS.	PART NUMBER

THIS DRAWING IS A CONTROLLED DOCUMENT.

DIMENSIONS: mm	TOLERANCES UNLESS OTHERWISE SPECIFIED:	DWN		TE Connectivity	
	0 PLC ±	CHK	NAME		
	1 PLC ±0.3	APVD	ATX POWER CONNECTOR		
	2 PLC ±0.2	PRODUCT SPEC	4.2mm PITCH, VERTICAL, DIP TYPE		
	3 PLC ±0.15	APPLICATION SPEC	SIZE	CAGE CODE	DRAWING NO
	4 PLC ±	WEIGHT	A3	00779	C=1775099
MATERIAL	FINISH	CUSTOMER DRAWING	SCALE	SHEET	REV
				2 OF 6	F

THIS DRAWING IS UNPUBLISHED. RELEASED FOR PUBLICATION
 © COPYRIGHT 2010 BY TYCO ELECTRONICS CORPORATION. ALL RIGHTS RESERVED.

LOC	DIST	REVISIONS					
DW		P	LTR	DESCRIPTION	DATE	DWN	APVD
				SEE SHEET 1.			

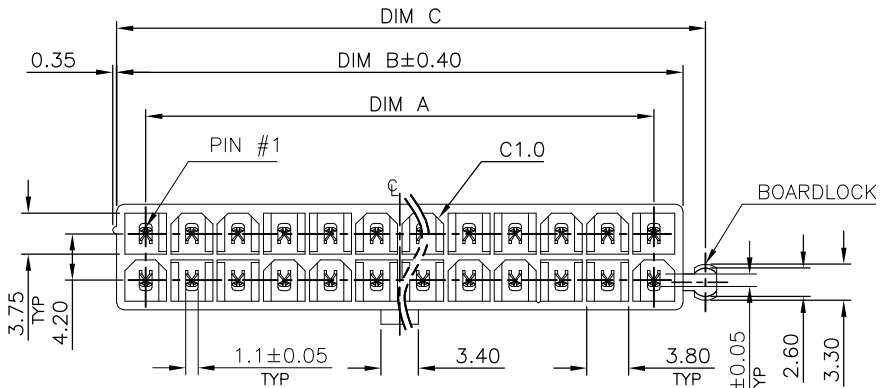

- NOTE:
- MATERIAL:
HOUSING: PA9T, UL94 V-0, COLOR: (SEE TABLE).
CONTACTS: BRASS.
 - FINISH:
CONTACTS: 3.05um [120u"] MIN. MATTE-TIN.
1.27um [50u"] MIN. NICKEL UNDERPLATED ALL OVER.
 - WAVE SOLDER CAPABLE TO 265°C PER TEST SPEC.
109-202, CONDITION B.
 - NO TE LOGO AND DATE CODE ON THE PRODUCT WITH 4 POS.
 - THE KEY IDENTIFIED WAS SHOWN ON PAGE 5.

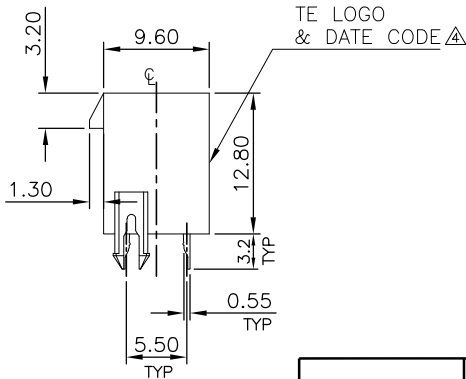
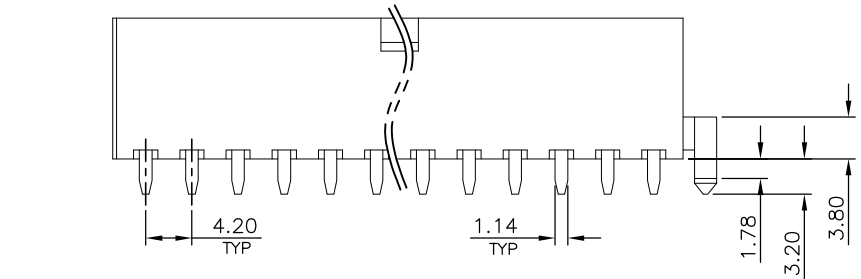

ONE BOARDLOCK (RIGHT)

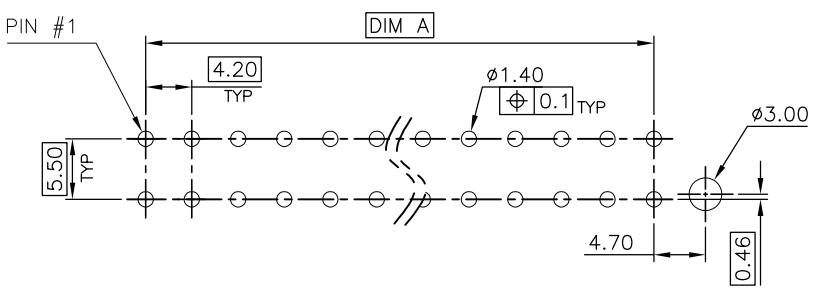

IVORY PA9T	5.40	46.2	51.5	53.55	24	3-1775099-8
	4.30	37.8	43.1	45.15	20	3-1775099-7
	3.90	33.6	38.9	40.95	18	3-1775099-6
	3.11	25.2	30.5	32.55	14	3-1775099-5
	2.71	21.0	26.3	28.35	12	3-1775099-4
	2.31	16.8	22.1	24.15	10	3-1775099-3
	1.92	12.6	17.9	19.95	8	3-1775099-2
	1.52	8.4	13.7	15.75	6	3-1775099-1
	1.13	4.2	9.5	11.55	4	3-1775099-0
HSG COLOR & MATERIAL	WEIGHT	DIM A	DIM B	DIM C	POS.	PART NUMBER

THIS DRAWING IS A CONTROLLED DOCUMENT.

DIMENSIONS: mm	TOLERANCES UNLESS OTHERWISE SPECIFIED:	DWN		TE Connectivity		
	0 PLC ±	CHK	NAME			
	1 PLC ± 0.3	APVD	ATX POWER CONNECTOR			
	2 PLC ± 0.2	PRODUCT SPEC	4.2mm PITCH, VERTICAL, DIP TYPE			
	3 PLC ± 0.15	APPLICATION SPEC	SIZE	CAGE CODE	DRAWING NO	RESTRICTED TO
4 PLC ±	ANGLES ± 3'	WEIGHT	A3	00779	C=1775099	
MATERIAL	FINISH	CUSTOMER DRAWING	SCALE	SHEET	3 OF 6	REV F

LOC	DIST	REVISIONS					
DW		P	LTR	DESCRIPTION	DATE	DWN	APVD
				SEE SHEET 1.			

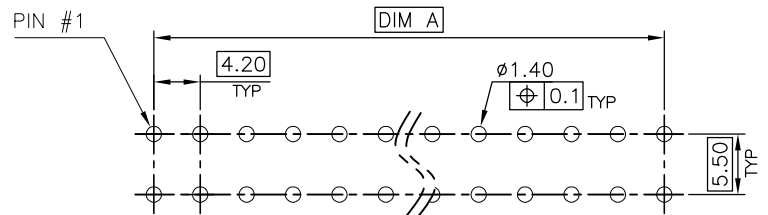
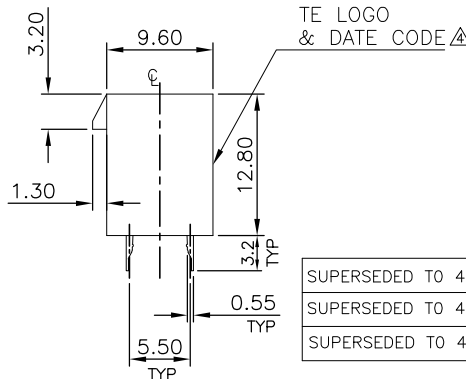
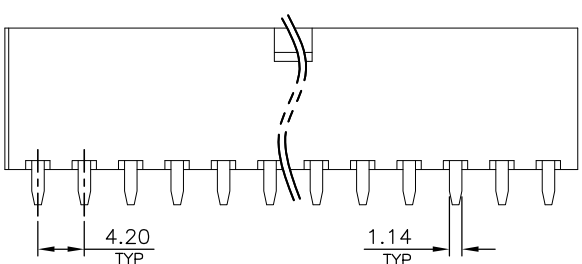
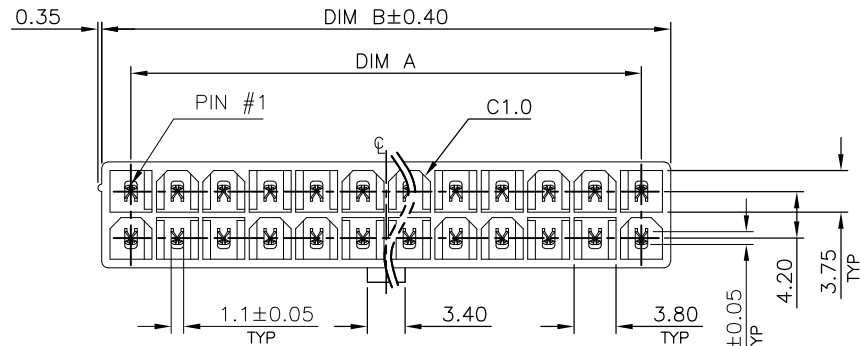

RECOMMENDED PCB LAYOUT
 TOLERANCE: ±0.05 T=1.6mm

- NOTE:
- MATERIAL:
 HOUSING: PA9T, UL94 V-0, COLOR: (SEE TABLE).
 CONTACTS: BRASS.
 - FINISH:
 CONTACTS: 3.05um [120u"] MIN. MATTE-TIN.
 1.27um [50u"] MIN. NICKEL UNDERPLATED ALL OVER.
 - WAVE SOLDER CAPABLE TO 265°C PER TEST SPEC.
 109-202, CONDITION B.
 - NO TE LOGO AND DATE CODE ON THE PRODUCT WITH 4 POS.
 - THE KEY IDENTIFIED WAS SHOWN ON PAGE 5.

NO BOARDLOCK

SUPERSEDED TO 4-1775099-3	IVORY PA9T	2.28	16.8	22.1	10	5-1775099-3
SUPERSEDED TO 4-1775099-2		1.89	12.6	17.9	8	5-1775099-2
SUPERSEDED TO 4-1775099-1		1.49	8.4	13.7	6	5-1775099-1
	IVORY PA9T	5.37	46.2	51.5	24	4-1775099-8
		4.27	37.8	43.1	20	4-1775099-7
		3.87	33.6	38.9	18	4-1775099-6
		3.08	25.2	30.5	14	4-1775099-5
		2.68	21.0	26.3	12	4-1775099-4
		2.28	16.8	22.1	10	4-1775099-3
		1.89	12.6	17.9	8	4-1775099-2
	1.49	8.4	13.7	6	4-1775099-1	
		1.10	4.2	9.5	4	4-1775099-0
	HSG COLOR & MATERIAL	WEIGHT	DIM A	DIM B	POS.	PART NUMBER

THIS DRAWING IS A CONTROLLED DOCUMENT.		DWN	TE Connectivity			
DIMENSIONS: mm		CHK	NAME			
TOLERANCES UNLESS OTHERWISE SPECIFIED:		APVD	ATX POWER CONNECTOR 4.2mm PITCH, VERTICAL, DIP TYPE			
0 PLC ± -		PRODUCT SPEC	SIZE	CAGE CODE	DRAWING NO	RESTRICTED TO
1 PLC ± 0.3		APPLICATION SPEC	A3	00779	C=1775099	-
2 PLC ± 0.2		WEIGHT	SEE TABLE		SCALE	SHEET 4 OF 6
3 PLC ± 0.15		CUSTOMER DRAWING			REV	F
4 PLC ANGLES ± 3'						
MATERIAL						
FINISH						

4

3

2

1

THIS DRAWING IS UNPUBLISHED. RELEASED FOR PUBLICATION
 © COPYRIGHT 2010 BY TYCO ELECTRONICS CORPORATION. ALL RIGHTS RESERVED.

LOC	DIST	REVISIONS					
DW		P	LTR	DESCRIPTION	DATE	DWN	APVD
				SEE SHEET 1.			

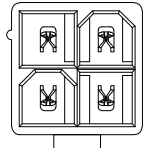

4 POS

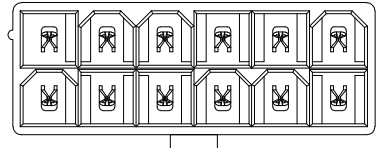

12 POS

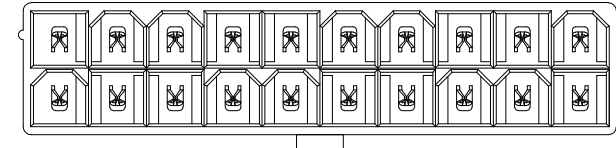

20 POS

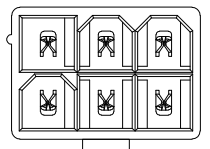

6 POS

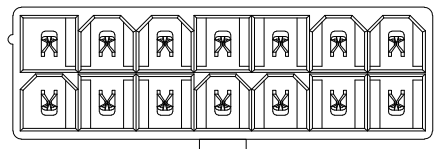

14 POS

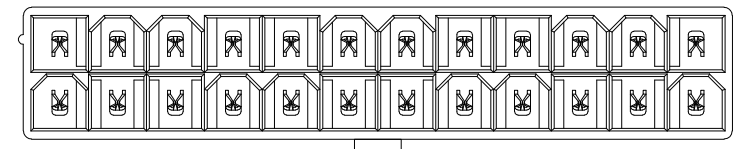

24 POS

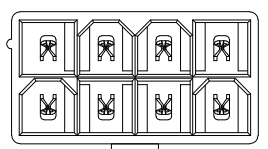

8 POS

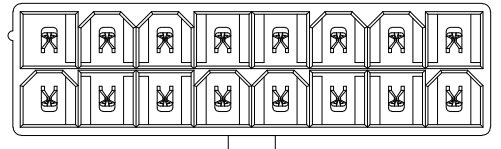

16 POS

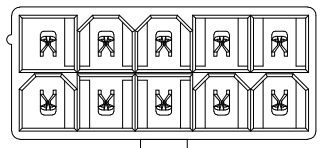

10 POS

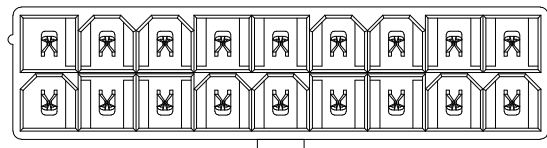

18 POS

KEY POSITION IDENTIFIED
(TOP VIEW)

THIS DRAWING IS A CONTROLLED DOCUMENT.		DWN	TE Connectivity			
DIMENSIONS: mm		CHK	NAME			
		APVD	ATX POWER CONNECTOR 4.2mm PITCH, VERTICAL, DIP TYPE			
TOLERANCES UNLESS OTHERWISE SPECIFIED:		PRODUCT SPEC	SIZE	CAGE CODE	DRAWING NO	RESTRICTED TO
0 PLC ± -		APPLICATION SPEC	A3	00779	C-1775099	-
1 PLC ± 0.3		WEIGHT	CUSTOMER DRAWING			SCALE
2 PLC ± 0.2			SHEET 5 of 6			REV F
3 PLC ± 0.15						
4 PLC ± -						
ANGLES ± 3'						
FINISH						

LOC	DIST	REVISIONS					
DW		P	LTR	DESCRIPTION	DATE	DWN	APVD
				SEE SHEET 1.			

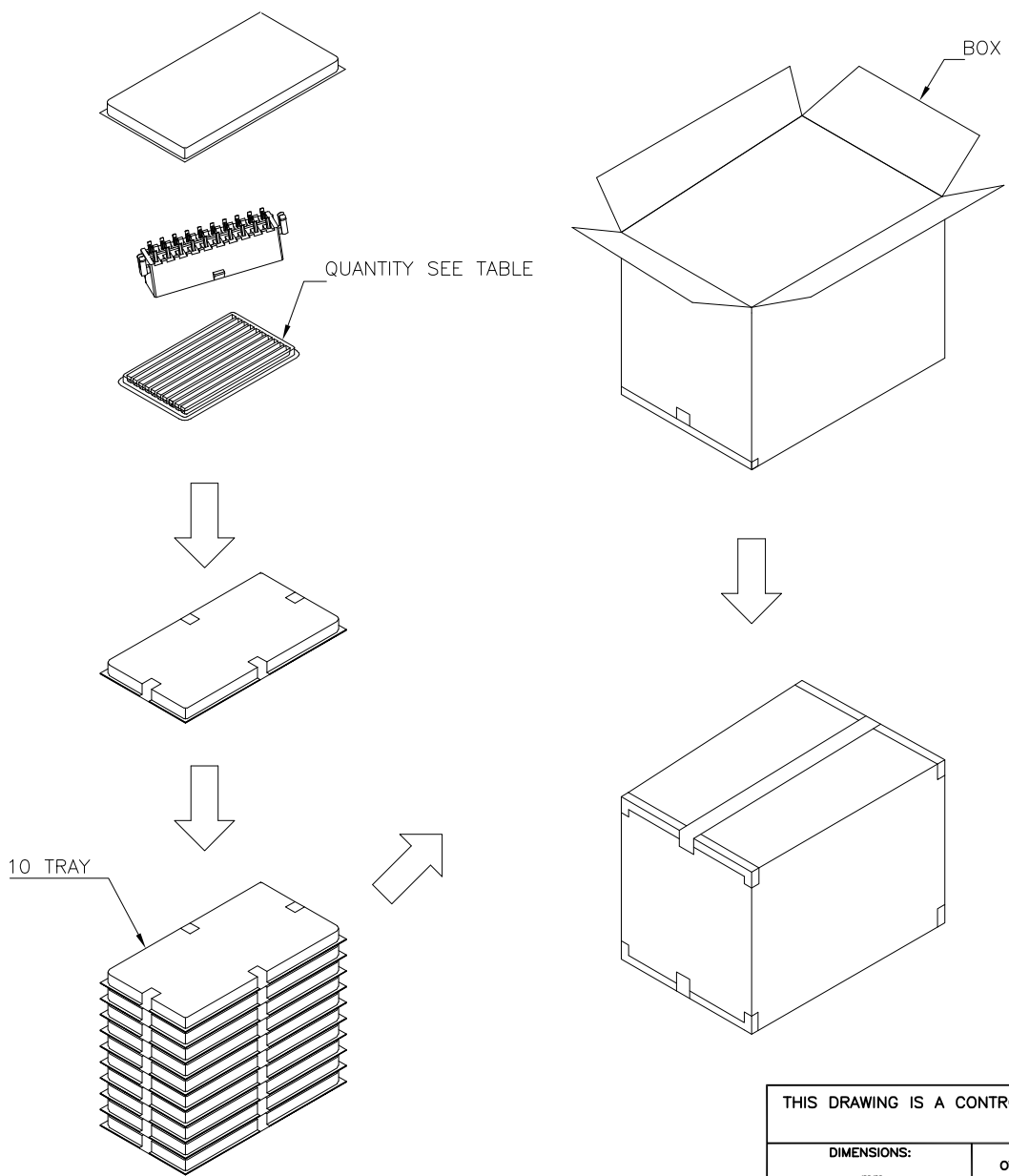

NOTES:
 1. TRAY : PVC, SIZE: 330mm(L) X 265mm(W) X 22mm(H).
 2. BOX : CORRUGATED, SIZE: 350mm(L) X 279mm(W) X 195mm(H).
 3. QUANTITY: SEE TABLE.

5.94	4.34	80	10	800	24	2	
5.93	4.33	100	10	1000	20		
5.53	3.93	100	10	1000	18		
5.85	4.25	120	10	1200	16		
6.00	4.40	140	10	1400	14		
5.98	4.38	160	10	1600	12		
5.81	4.21	180	10	1800	10		
5.89	4.29	220	10	2200	8		
5.94	4.34	280	10	2800	6		
5.78	4.18	360	10	3600	4		
5.92	4.32	80	10	800	24	1	
5.90	4.30	100	10	1000	20		
6.28	4.68	120	10	1200	18		
5.95	4.35	140	10	1400	14		
5.94	4.34	160	10	1600	12		
6.22	4.62	200	10	2000	10		
6.21	4.61	240	10	2400	8		
6.16	4.56	300	10	3000	6		
6.35	4.75	420	10	4200	4		
5.90	4.30	80	10	800	24		
5.87	4.27	100	10	1000	20	0	
6.24	4.64	120	10	1200	18		
5.91	4.31	140	10	1400	14		
6.42	4.82	180	10	1800	12		
6.16	4.56	200	10	2000	10		
6.51	4.91	260	10	2600	8		
6.67	5.07	340	10	3400	6		
6.88	5.28	480	10	4800	4		
GROSS WEIGHT	NET WEIGHT	PCS /TRAY	TRAYS /BOX	PCS /BOX	POS.		NO. OF BOARDLOCK

THIS DRAWING IS A CONTROLLED DOCUMENT.

DIMENSIONS: mm	TOLERANCES UNLESS OTHERWISE SPECIFIED:	DWN	TE Connectivity
	0 PLC ± -	CHK	
	1 PLC ± 0.3	APVD	
	2 PLC ± 0.2	PRODUCT SPEC	
	3 PLC ± 0.15	APPLICATION SPEC	NAME
	4 PLC ANGLES ± -	WEIGHT	ATX POWER CONNECTOR 4.2mm PITCH, VERTICAL, DIP TYPE
MATERIAL	FINISH	CUSTOMER DRAWING	SIZE CAGE CODE DRAWING NO RESTRICTED TO
			A3 00779 C=1775099
			SCALE SHEET 6 OF 6 REV F

Mouser Electronics

Authorized Distributor

Click to View Pricing, Inventory, Delivery & Lifecycle Information:

[TE Connectivity:](#)

[1-1775099-3](#)