

**Top View of Assembly**

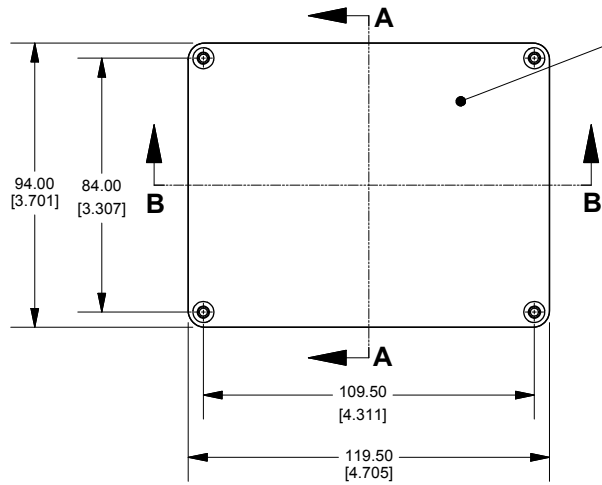

**SECTION A-A  
End View of Assembly**

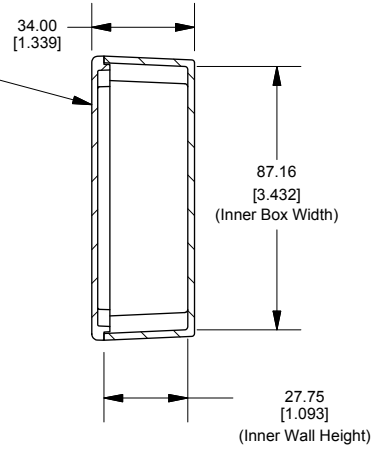

**SECTION B-B  
Side View of Assembly**

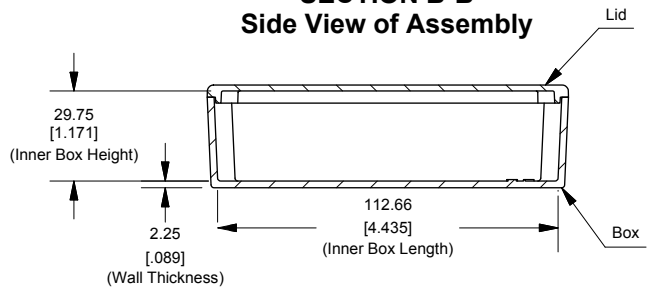

**Top View Looking Inside Box**

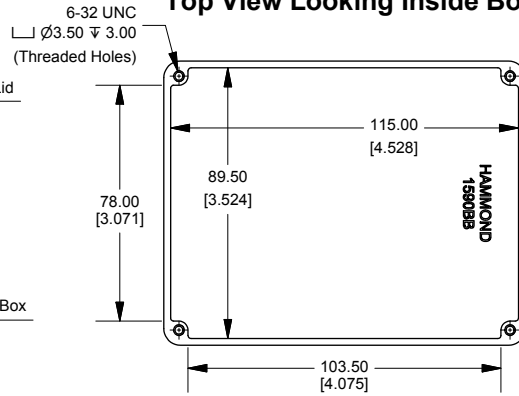

**Lid**

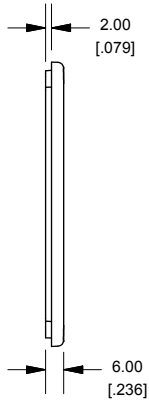
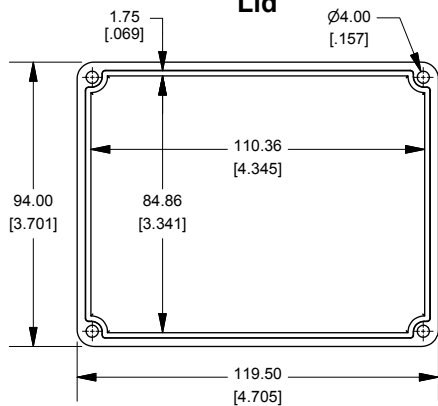

Enclosures can be Factory Modified ( Milling, Drilling, Printing etc.)  
Contact Factory [mjm@hammondmfg.com](mailto:mjm@hammondmfg.com) for quotes  
Solid models of this enclosure available in STEP or IGES.

**NOTE**

Purchased assembly includes box, lid and 4 cover screws.  
Box and lid are made from Diecast Aluminum Alloy.  
Silicone Gasket supplied with liquid resistant enclosure.

**PART NUMBERS**

1590BB Enclosure	
Natural Finish Enclosure	1590BB
Black Textured Enclosure	1590BBBK
1590BB Liquid Resistant Enclosure (Silicone Gasket)	
Natural Finish Enclosure	1590WBB
Black Textured Enclosure	1590WBBBK

**ACCESSORIES**

**Recommended Torque: 75 ozf.in / 55 cN.m**

**Liquid Resistant Cover Screws**

Stainless Steel Cover Screws (Pkg 100) [6-32 x 1/2" With O-Ring]	1590WMS100
Black Stainless Steel Cover Screws (Pkg 100) [6-32 x 1/2" With O-Ring]	1590WMS100BK
Standard Cover Screws	
Plated Cover Screws (Pkg 100) [6-32 x 1/2"]	1590MS100
Black Cover Screws (Pkg 100) [6-32 x 1/2"]	1590MS100BK

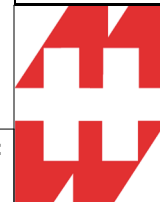

**HAMMOND  
MANUFACTURING™**

**1590BB**

[www.hammondmfg.com](http://www.hammondmfg.com)

**Dimensions:**  
mm  
[inches]