

Type 4, 4X Stainless Steel Pushbutton Enclosures *1435SS Series*



Application

- Designed to accept standard heavy duty oil tight pushbuttons, switches and pilot lights.
- Provides protection from dirt, dust, oil and large amounts of water from any angle, or where highly corrosive conditions exist.

Standards

- UL 508 Type 4 and 4X
- CSA Type 4 and 4X
- **Complies with**
 - NEMA Type 3R, 4 and 4X
 - JIC Standard EGP-1-1967
 - IEC 60529, IP66
- Appropriate components are required to maintain these standards.

Construction

- Formed 14 gauge stainless steel except A and B which are 16 gauge. 304 or 316 SS.
- Smooth continuously welded seams.
- Welded brackets provide for enclosure mounting.
- Captive stainless steel cover screws thread into sealed wells.
- Larger enclosures provide internally hinged removable covers, designed to hold the cover open during wiring.
- Oil resistant gasket and adhesive.
- A bonding stud is provided on the door and a grounding stud is provided on the enclosure.

Finish

- Natural stainless steel with a smooth brushed finish.

Accessories

- Hole Plugs

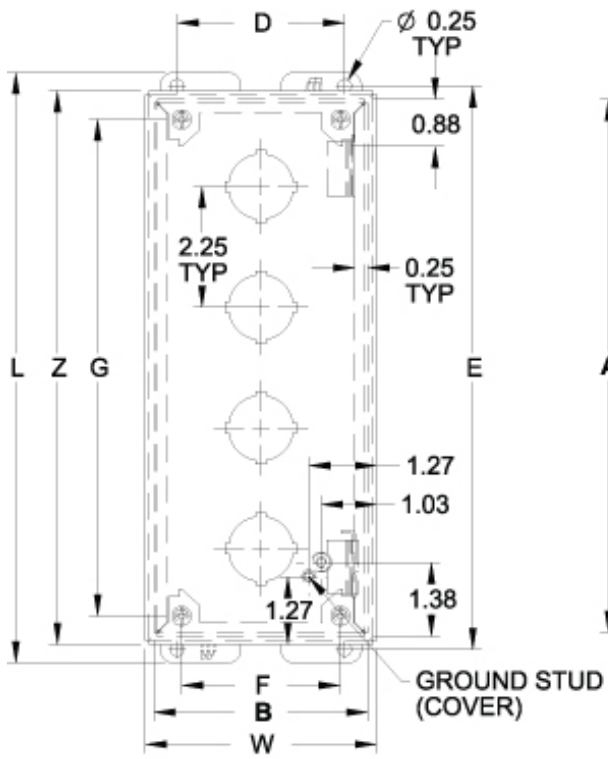

Front View
Body Type B through S
(Hinged)

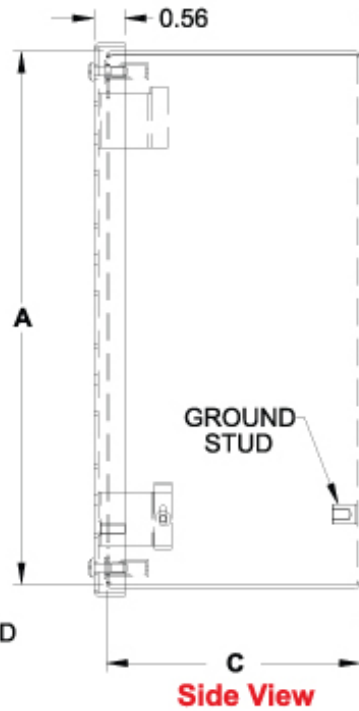

Side View

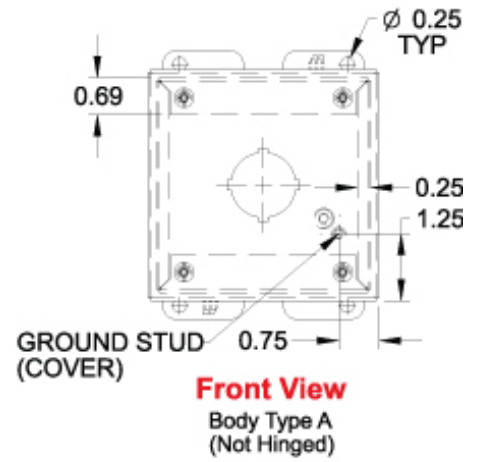

Front View
Body Type A
(Not Hinged)

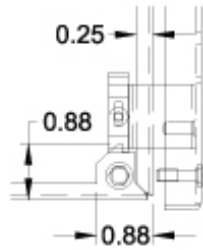

Hinge Detail
Retractable pin allows door to be
mounted on left or right side

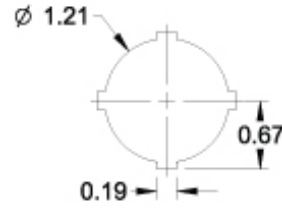

30.5mm Detail
(1435 Series)

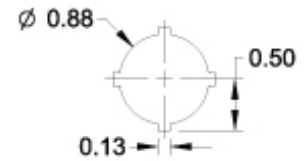

22.5mm Detail
(1435M Series)

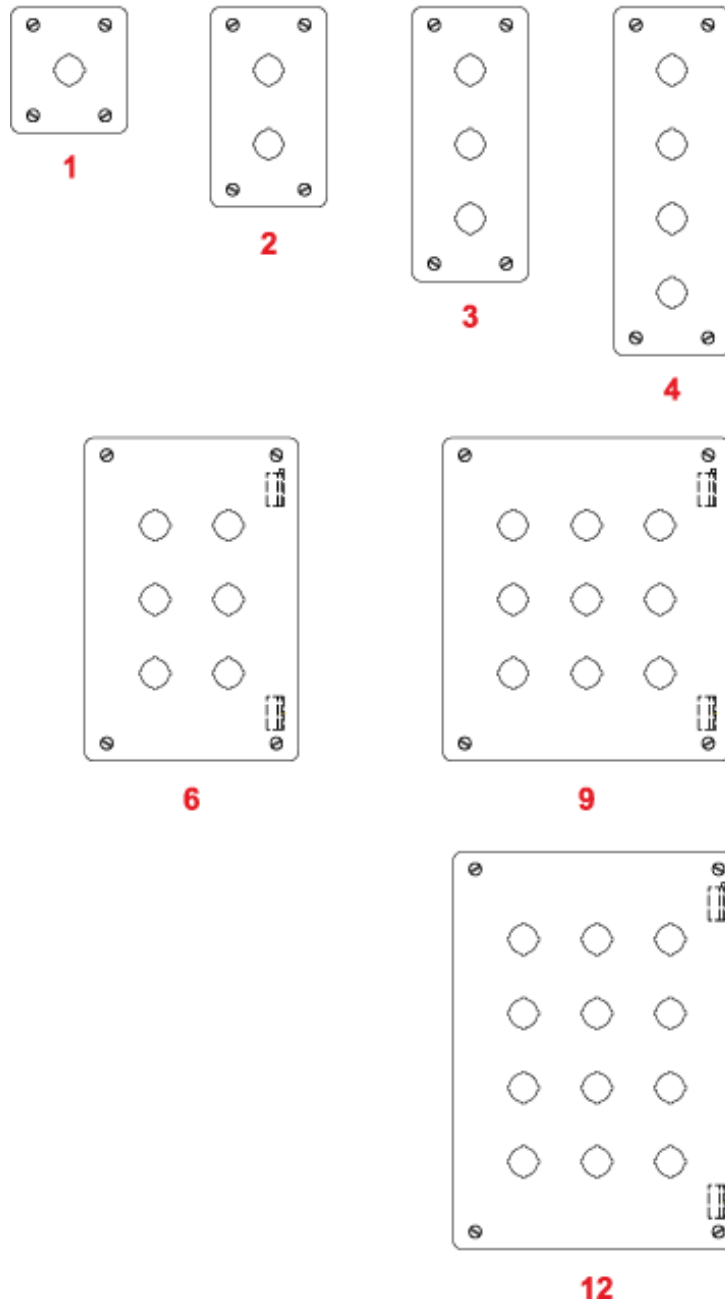

Part No.				No. Of Holes	Overall Dimensions							Ship lbs.			
304 S.S. 22.5mm	304 S.S. 30.5mm	316 S.S. 22.5mm	316 S.S. 30.5mm		A	B	C	D	E	F	G		L	W	Z
1435MSSA ¹	1435SSA ¹	1435MS16A ¹	1435S16A ¹	1	3.50	3.25	2.75	2.38	4.00	2.21	2.75	4.50	3.56	3.81	2
1435MSSB ¹	1435SSB ¹	1435MS16B ¹	1435S16B ¹	2	5.75	3.25	2.75	2.38	6.25	2.21	5.00	6.75	3.56	6.06	3
1435MSSC ¹	1435SSC ¹	1435MS16C ¹	1435S16C ¹	3	8.00	3.25	2.75	2.38	8.50	2.21	7.25	9.00	3.56	8.31	3
1435MSSD ¹	1435SSD ¹	1435MS16D ¹	1435S16D ¹	4	10.25	3.25	2.75	2.38	10.75	2.21	9.50	11.25	3.56	10.56	4
1435MSSH	1435SSH	1435MS16H	1435S16H	6	9.50	6.25	3.00	5.38	10.00	5.21	8.75	10.50	6.56	9.81	6
1435MSSK	1435SSK	1435MS16K	1435S16K	9	9.50	8.50	3.00	7.63	10.00	7.46	8.75	10.50	8.81	9.81	7
1435MSSO	1435SSO	1435MS16O	1435S16O	12	11.75	8.50	3.00	7.63	12.25	7.46	11.00	12.75	8.81	12.06	8

¹ Not hinged

Data subject to change without notice

