



Bridgelux® Décor Series™ on Vero® SE Series LED Array

Product Data Sheet DS124



BXRC-27H1000	27H2000	27H4000	30H1000	30H2000	30H4000
BXRC-17E4000	25E4000	56G4001	17E10K0	25E10K0	56G10K1

Introduction

Vero SE



The Bridgelux Décor Series™ on Vero® SE Series line of products produce unmatched quality of light with brilliant color rendering options designed specifically for high end, niche applications. The Bridgelux Décor Series line of specialty LED products is available on the Bridgelux Vero SE Series of chip on board products.

Décor Series™ Ultra products provide a high CRI of 97, befitting of the most luxurious retail shops and world renowned museums.

Décor Series™ Food products offer color points developed to address the unique requirements of the food, grocery, and restaurant industries. Highlighting the distinctive colors and nuanced patterns found in meats and breads, the Décor Food products are a must have for any butcher counter or bakery.

Décor Series™ Specialty products provide color points developed specifically for the healthcare and entertainment industries. The 5600K color point combined with a CRI of 90 provides the bright white required by these industries.

Décor Series on Vero SE is available in four different light emitting surface (LES) configurations and has been engineered to reliably operate over a broad current range, enabling new degrees of flexibility in luminaire design optimization. Décor Series on Vero SE arrays deliver increased lumen density to enable improved beam control and precision lighting with 2, 3 and 4 SDCM color control standard for clean and consistent uniform lighting.

Décor includes poke-in connectivity to enable simplified manufacturing and assembly processes. Secondary connector and holder components are not required, allowing the integration of arrays into fixtures more streamlined without the need for soldering.

Features

- Poke-in connectivity
- Typical 97 CRI with a 95 CRI minimum (Décor Series Ultra)
- Application specific color points
- Typical R9 value of 98 for brilliant rendering of red colors and skin tones (Décor Series Ultra)
- 2 and 3 SDCM color control
- Reliable operation at up to 2X nominal drive current
- Radial die pattern and improved lumen density
- Top side part number markings
- No exposed solder pads or electrical connections

Benefits

- Poke-in connectivity enables solderless and connector free installation
- Broad application coverage for interior lighting requiring state of the art color rendering
- Flexibility for application driven lighting design requirements
- High quality true color reproduction
- Uniform consistent white light
- Flexibility in design optimization
- Improved optical control
- Enhanced ease of use and manufacturability
- Ability to configure multiple arrays in series and parallel reduces customer driver cost
- Improved inventory management and quality control



Contents

Product Feature Map	2
Product Nomenclature	2
Product Selection Guide	3
Performance at Commonly Used Drive Currents	5
Electrical Characteristics	10
Eye Safety	11
Absolute Maximum Ratings	12
Performance Curves	13
Typical Radiation Pattern	20
Typical Color Spectrum	21
Mechanical Dimensions	22
Color Binning Information	26
Packaging and Labeling	27
Design Resources	30
Precautions	30
Disclaimers	30
About Bridgelux	31

Product Feature Map

In addition to delivering the performance and light quality required for many lighting applications, Décor Series on Vero SE LED arrays incorporate several features to

simplify the design integration and manufacturing process, accelerate time to market and reduce system costs.

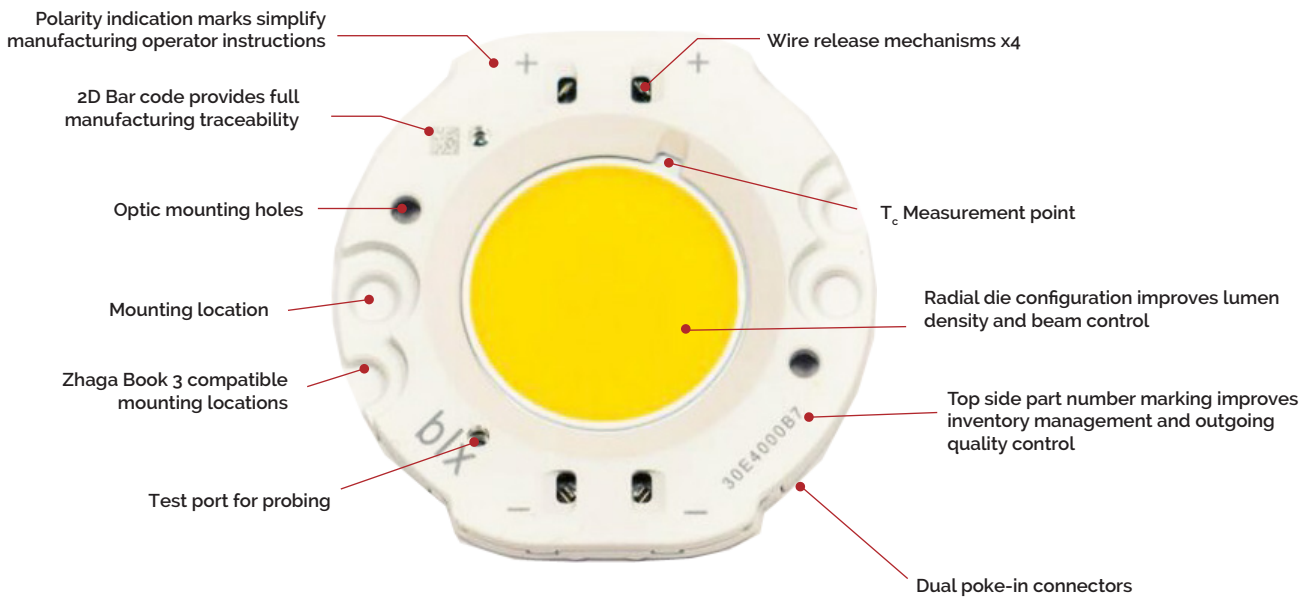

Product Nomenclature

The part number designation for Bridgelux Décor Series on Vero SE LED arrays is explained as follows:

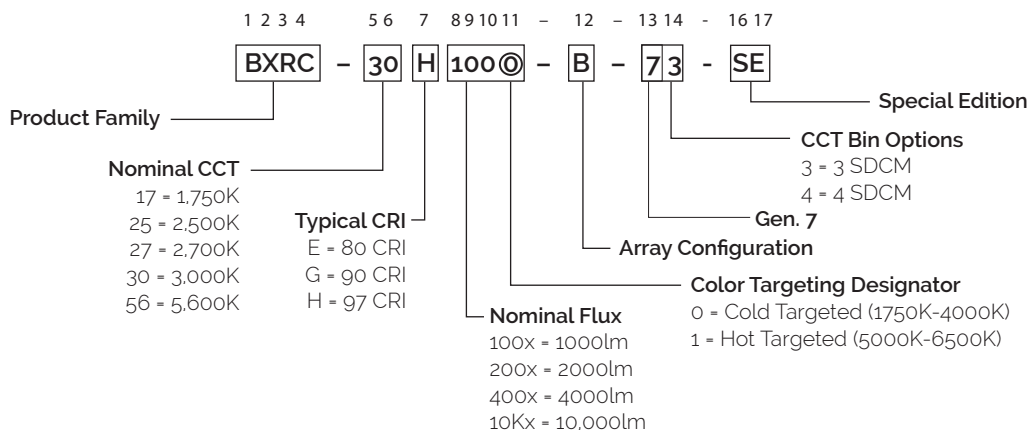

Product Selection Guide

The following product configurations are available:

Table 1: Selection Guide, Pulsed Measurement Data ($T_j = T_c = 25^\circ\text{C}$)

Product	Part Number	Nominal CCT ¹ (K)	CRI ²	Nominal Drive Current ³ (mA)	Typical Pulsed Flux ^{4,5,6} $T_c = 25^\circ\text{C}$ (lm)	Minimum Pulsed Flux ^{6,7} $T_c = 25^\circ\text{C}$ (lm)	Typical V_f (V)	Typical Power (W)	Typical Efficacy (lm/W)
Décor Ultra Vero SE 10B	BXRC-27H1000-B-7x-SE	2700	97	270	1028	905	35.0	9.5	109
Décor Ultra Vero SE 10C	BXRC-27H1000-C-7x-SE	2700	97	360	1371	1206	35.0	12.6	109
Décor Ultra Vero SE 10D	BXRC-27H1000-D-7x-SE	2700	97	350	999	880	26.0	9.1	110
Décor Ultra Vero SE 10B	BXRC-30H1000-B-7x-SE	3000	97	270	1101	969	35.0	9.5	117
Décor Ultra Vero SE 10C	BXRC-30H1000-C-7x-SE	3000	97	360	1468	1292	35.0	12.6	116
Décor Ultra Vero SE 10D	BXRC-30H1000-D-7x-SE	3000	97	350	1070	942	26.0	9.1	118
Décor Ultra Vero SE 13B	BXRC-27H2000-B-7x-SE	2700	97	450	1789	1611	35.0	15.8	114
Décor Ultra Vero SE 13C	BXRC-27H2000-C-7x-SE	2700	97	630	2505	2255	35.0	22.1	114
Décor Ultra Vero SE 13D	BXRC-27H2000-D-7x-SE	2700	97	500	1823	1641	31.8	15.9	115
Décor Ultra Vero SE 13B	BXRC-30H2000-B-7x-SE	3000	97	450	1912	1721	35.0	15.8	121
Décor Ultra Vero SE 13C	BXRC-30H2000-C-7x-SE	3000	97	630	2676	2409	35.0	22.1	121
Décor Ultra Vero SE 13D	BXRC-30H2000-D-7x-SE	3000	97	500	1947	1752	31.8	15.9	122
Décor Ultra Vero SE 18B	BXRC-27H4000-B-7x-SE	2700	97	900	3605	3243	35.0	31.5	114
Décor Ultra Vero SE 18C	BXRC-27H4000-C-7x-SE	2700	97	1170	4686	4217	35.0	41.0	114
Décor Ultra Vero SE 18D	BXRC-27H4000-D-7x-SE	2700	97	1050	3504	3153	29.0	30.5	115
Décor Ultra Vero SE 18B	BXRC-30H4000-B-7x-SE	3000	97	900	3850	3465	35.0	31.5	122
Décor Ultra Vero SE 18C	BXRC-30H4000-C-7x-SE	3000	97	1170	5007	4506	35.0	41.0	122
Décor Ultra Vero SE 18D	BXRC-30H4000-D-7x-SE	3000	97	1050	3744	3370	29.0	30.5	123
Décor Food Vero SE 18B	BXRC-17E4000-B-74-SE	1750	80	900	2649	2385	35.0	31.5	84
Décor Food Vero SE 18C	BXRC-17E4000-C-74-SE	1750	80	1170	3445	3100	35.0	41.0	84
Décor Food Vero SE 18D	BXRC-17E4000-D-74-SE	1750	80	1050	2576	2318	29.0	30.5	85
Décor Food Vero SE 18B	BXRC-25E4000-B-74-SE	2500	80	900	4282	3853	35.0	31.5	136
Décor Food Vero SE 18C	BXRC-25E4000-C-74-SE	2500	80	1170	5568	5011	35.0	41.0	136
Décor Food Vero SE 18D	BXRC-25E4000-D-74-SE	2500	80	1050	4163	3747	29.0	30.5	137
Décor Specialty Vero SE 18B	BXRC-56G4001-B-74-SE	5600	90	900	4559	4103	35.0	31.5	145
Décor Specialty Vero SE 18C	BXRC-56G4001-C-74-SE	5600	90	1170	5928	5335	35.0	41.0	145
Décor Specialty Vero SE 18D	BXRC-56G4001-D-74-SE	5600	90	1050	4433	3989	29.0	30.5	146
Décor Food Vero SE 29B	BXRC-17E10K0-B-74-SE	1750	80	1800	8033	7230	52.0	93.6	86
Décor Food Vero SE 29C	BXRC-17E10K0-C-74-SE	1750	80	1710	10175	9157	69.4	118.7	86
Décor Food Vero SE 29D	BXRC-17E10K0-D-74-SE	1750	80	2100	6768	6092	37.6	79.0	86
Décor Food Vero SE 29B	BXRC-25E10K0-B-74-SE	2500	80	1800	12983	11685	52.0	93.6	139
Décor Food Vero SE 29C	BXRC-25E10K0-C-74-SE	2500	80	1710	16446	14801	69.4	118.7	139
Décor Food Vero SE 29D	BXRC-25E10K0-D-74-SE	2500	80	2100	10940	9845	37.6	79.0	139
Décor Specialty Vero SE 29B	BXRC-56G10K1-B-74-SE	5600	90	1800	13824	12442	52.0	93.6	148
Décor Specialty Vero SE 29C	BXRC-56G10K1-C-74-SE	5600	90	1710	17510	15760	69.4	118.7	148
Décor Specialty Vero SE 29D	BXRC-56G10K1-D-74-SE	5600	90	2100	11648	10483	37.6	79.0	148

Notes for Table 1:

- Nominal CCT as defined by ANSI C78.377-2011. Products with CCTs 5000K-6500K are hot targeted to 85°C.
- CRI Values are minimums. Minimum Rg value at $T_j = T_c = 25^\circ\text{C}$ for 80 CRI products is 0, the minimum Rg values for warm white and neutral white 90 CRI products is 60, the minimum Rg values for cool white 90 CRI products is 50.
- Drive current is referred to as nominal drive current.
- Products tested under pulsed condition (10ms pulse width) at nominal test current where T_j (junction temperature) = T_c (case temperature) = 25°C.
- Typical performance values are provided as a reference only and not a guarantee of performance.
- Bridgelux maintains a $\pm 7\%$ tolerance on flux measurements.
- Minimum flux values at the nominal test current are guaranteed by 100% test.

Product Selection Guide

The following product configurations are available:

Table 2: Selection Guide, Stabilized DC Performance ($T_c = 85^\circ\text{C}$)^{4,5}

Product	Part Number	Nominal CCT ¹ (K)	CRI ²	Nominal Drive Current ³ (mA)	Typical DC Flux $T_c = 85^\circ\text{C}$ (lm)	Minimum DC Flux ⁶ $T_c = 85^\circ\text{C}$ (lm)	Typical V_f (V)	Typical Power (W)	Typical Efficacy (lm/W)
Décor Ultra Vero SE 10B	BXRC-27H1000-B-7x-SE	2700	97	270	926	814	34.0	9.2	101
Décor Ultra Vero SE 10C	BXRC-27H1000-C-7x-SE	2700	97	360	1233	1086	34.0	12.3	101
Décor Ultra Vero SE 10D	BXRC-27H1000-D-7x-SE	2700	97	350	899	792	25.3	8.9	102
Décor Ultra Vero SE 10B	BXRC-30H1000-B-7x-SE	3000	97	270	991	872	34.0	9.2	108
Décor Ultra Vero SE 10C	BXRC-30H1000-C-7x-SE	3000	97	360	1321	1163	34.0	12.3	108
Décor Ultra Vero SE 10D	BXRC-30H1000-D-7x-SE	3000	97	350	963	848	25.3	8.9	109
Décor Ultra Vero SE 13B	BXRC-27H2000-B-7x-SE	2700	97	450	1611	1450	34.1	15.3	105
Décor Ultra Vero SE 13C	BXRC-27H2000-C-7x-SE	2700	97	630	2254	3468	34.1	21.5	105
Décor Ultra Vero SE 13D	BXRC-27H2000-D-7x-SE	2700	97	500	1641	4510	30.9	15.5	106
Décor Ultra Vero SE 13B	BXRC-30H2000-B-7x-SE	3000	97	450	1721	1549	34.1	15.3	112
Décor Ultra Vero SE 13C	BXRC-30H2000-C-7x-SE	3000	97	630	2409	2168	34.1	21.5	112
Décor Ultra Vero SE 13D	BXRC-30H2000-D-7x-SE	3000	97	500	1753	1577	30.9	15.5	113
Décor Ultra Vero SE 18B	BXRC-27H4000-B-7x-SE	2700	97	900	3244	2919	34.1	30.7	106
Décor Ultra Vero SE 18C	BXRC-27H4000-C-7x-SE	2700	97	1170	4218	3796	34.3	40.1	105
Décor Ultra Vero SE 18D	BXRC-27H4000-D-7x-SE	2700	97	1050	3153	2838	28.1	29.5	107
Décor Ultra Vero SE 18B	BXRC-30H4000-B-7x-SE	3000	97	900	3465	3119	34.1	30.7	113
Décor Ultra Vero SE 18C	BXRC-30H4000-C-7x-SE	3000	97	1170	4506	4055	34.3	40.1	112
Décor Ultra Vero SE 18D	BXRC-30H4000-D-7x-SE	3000	97	1050	3369	3033	28.1	29.5	114
Décor Food Vero SE 18B	BXRC-17E4000-B-74-SE	1750	80	900	2384	2146	34.1	30.7	78
Décor Food Vero SE 18C	BXRC-17E4000-C-74-SE	1750	80	1170	3100	2790	34.3	40.1	77
Décor Food Vero SE 18D	BXRC-17E4000-D-74-SE	1750	80	1050	2318	2087	28.1	29.5	79
Décor Food Vero SE 18B	BXRC-25E4000-B-74-SE	2500	80	900	3853	3468	34.1	30.7	126
Décor Food Vero SE 18C	BXRC-25E4000-C-74-SE	2500	80	1170	5011	4510	34.3	40.1	125
Décor Food Vero SE 18D	BXRC-25E4000-D-74-SE	2500	80	1050	3747	3372	28.1	29.5	127
Décor Specialty Vero SE 18B	BXRC-56G4001-B-74-SE	5600	90	900	4103	3693	34.1	30.7	134
Décor Specialty Vero SE 18C	BXRC-56G4001-C-74-SE	5600	90	1170	5335	4801	34.3	40.1	133
Décor Specialty Vero SE 18D	BXRC-56G4001-D-74-SE	5600	90	1050	3989	3591	28.1	29.5	135
Décor Food Vero SE 29B	BXRC-17E10K0-B-74-SE	1750	80	1800	7230	6507	50.7	91.2	79
Décor Food Vero SE 29C	BXRC-17E10K0-C-74-SE	1750	80	1710	9157	8241	68.4	116.9	78
Décor Food Vero SE 29D	BXRC-17E10K0-D-74-SE	1750	80	2100	6091	5483	36.3	76.2	80
Décor Food Vero SE 29B	BXRC-25E10K0-B-74-SE	2500	80	1800	11685	10516	50.7	91.2	128
Décor Food Vero SE 29C	BXRC-25E10K0-C-74-SE	2500	80	1710	14801	13321	68.4	116.9	127
Décor Food Vero SE 29D	BXRC-25E10K0-D-74-SE	2500	80	2100	9846	8861	36.3	76.2	129
Décor Specialty Vero SE 29B	BXRC-56G10K1-B-74-SE	5600	90	1800	12442	11198	50.7	91.2	136
Décor Specialty Vero SE 29C	BXRC-56G10K1-C-74-SE	5600	90	1710	15759	14184	68.4	116.9	135
Décor Specialty Vero SE 29D	BXRC-56G10K1-D-74-SE	5600	90	2100	10483	9434	36.3	76.2	138

Notes for Tables 2:

- Nominal CCT as defined by ANSI C78.377-2011. Products with a CCT of 5000K-6500K are hot targeted to 85°C.
- CRI Values are minimums. Minimum Rg value at $T_j = T_c = 25^\circ\text{C}$ for 80 CRI products is 0, the minimum Rg values for warm white and neutral white 90 CRI products is 60, the minimum Rg values for cool white 90 CRI products is 50.
- Drive current is referred to as nominal drive current.
- Typical stabilized DC performance values are provided as reference only and not a guarantee of performance.
- Typical performance is estimated based on operation under DC (direct current) with LED array mounted onto a heat sink with thermal interface material and the case temperature maintained at 85°C. Based on Bridgelux test setup, values may vary depending on the thermal design of the luminaire and/or the exposed environment to which the product is subjected.
- Minimum flux values at elevated temperatures are provided for reference only and are not guaranteed by 100% production testing. Based on Bridgelux test setup, values may vary depending on the thermal design of the luminaire and/or the exposed environment to which the product is subjected.

Performance at Commonly Used Drive Currents

Vero SE LED arrays are tested to the specifications shown using the nominal drive currents in Table 1. Vero SE may also be driven at other drive currents dependent on specific application design requirements. The performance at any drive current can be derived from the current vs. voltage characteristics shown in Figure 1-12 and the flux vs. current characteristics shown in Figures 13-24. The performance at commonly used drive currents is summarized in Table 3.

Table 3: Product Performance at Commonly Used Drive Currents

Product	Part Number	CRI	Drive Current ¹ (mA)	Typical V _f T _c = 25°C (V)	Typical Power T _c = 25°C (W)	Typical Flux ² T _c = 25°C (lm)	Typical DC Flux ³ T _c = 85°C (lm)	Typical Efficacy T _c = 25°C (lm/W)
Décor Ultra Vero SE 10	BXRC-27H1000-B-7x-SE	97	135	33.3	4.5	548	493	122
			180	33.8	6.1	719	647	118
			270	35.0	9.5	1028	926	109
			405	36.4	14.8	1509	1358	102
			540	37.8	20.4	1933	1740	95
Décor Ultra Vero SE 10	BXRC-27H1000-C-7x-SE	97	180	33.3	6.0	729	656	122
			240	33.8	8.1	955	859	118
			360	35.0	12.6	1371	1233	109
			540	36.4	19.7	1996	1796	102
			720	37.7	27.1	2549	2294	94
Décor Ultra Vero SE 10	BXRC-27H1000-D-7x-SE	97	175	24.9	4.4	534	480	122
			233	25.4	5.9	700	630	118
			350	26.0	9.1	999	899	110
			525	27.4	14.4	1471	1324	102
			700	28.4	19.9	1884	1696	95
Décor Ultra Vero SE 10	BXRC-30H1000-B-7x-SE	97	135	33.3	4.5	587	528	131
			180	33.8	6.1	769	693	126
			270	35.0	9.5	1101	991	117
			405	36.4	14.8	1616	1454	109
			540	37.8	20.4	2070	1863	102
Décor Ultra Vero SE 10	BXRC-30H1000-C-7x-SE	97	180	33.3	6.0	780	702	130
			240	33.8	8.1	1022	920	126
			360	35.0	12.6	1468	1321	116
			540	36.4	19.7	2137	1923	109
			720	37.7	27.1	2730	2457	101
Décor Ultra Vero SE 10	BXRC-30H1000-D-7x-SE	97	175	24.9	4.4	571	514	131
			233	25.4	5.9	750	675	127
			350	26.0	9.1	1070	963	118
			525	27.4	14.4	1575	1418	110
			700	28.4	19.9	2018	1816	101

Notes for Table 3:

1. Alternate drive currents in Table 3 are provided for reference only and are not a guarantee of performance.
2. Bridgelux maintains a ± 7% tolerance on flux measurements.
3. Typical stabilized DC performance values are provided as reference only and not a guarantee of performance.

Performance at Commonly Used Drive Currents

Table 3: Product Performance at Commonly Used Drive Currents (continued)

Product	Part Number	CRI	Drive Current ¹ (mA)	Typical V _f T _c = 25°C (V)	Typical Power T _c = 25°C (W)	Typical Flux ² T _c = 25°C (lm)	Typical DC Flux ³ T _c = 85°C (lm)	Typical Efficacy T _c = 25°C (lm/W)
Décor Ultra Vero SE 13	BXRC-27H2000-B-7x-SE	97	113	32.3	3.7	487	439	133
			225	33.2	7.5	943	849	126
			450	35.0	15.8	1789	1611	114
			675	36.3	24.5	2586	2327	106
			900	37.5	33.7	3299	2969	98
Décor Ultra Vero SE 13	BXRC-27H2000-C-7x-SE	97	158	32.3	5.1	677	609	132
			315	33.2	10.5	1310	1179	125
			630	35.0	22.1	2505	2254	114
			945	36.4	34.4	3595	3236	104
			1260	37.8	47.6	4589	4130	96
Décor Ultra Vero SE 13	BXRC-27H2000-D-7x-SE	97	125	29.6	3.7	483	434	131
			250	30.3	7.6	935	842	123
			500	31.8	15.9	1823	1641	115
			750	33.2	24.9	2576	2318	103
			1000	34.4	34.4	3294	2964	96
Décor Ultra Vero SE 13	BXRC-30H2000-B-7x-SE	97	113	32.3	3.7	521	469	143
			225	33.2	7.5	1008	907	135
			450	35.0	15.8	1912	1721	121
			675	36.3	24.5	2763	2487	113
			900	37.5	33.7	3525	3172	104
Décor Ultra Vero SE 13	BXRC-30H2000-C-7x-SE	97	158	32.3	5.1	723	651	142
			315	33.2	10.5	1400	1260	134
			630	35.0	22.1	2676	2409	121
			945	36.4	34.4	3841	3457	112
			1260	37.8	47.6	4903	4413	103
Décor Ultra Vero SE 13	BXRC-30H2000-D-7x-SE	97	125	29.6	3.7	515	464	140
			250	30.3	7.6	999	899	132
			500	31.8	15.9	1947	1753	122
			750	33.2	24.9	2752	2477	111
			1000	34.4	34.4	3519	3167	102
Décor Ultra Vero SE 18	BXRC-27H4000-B-7x-SE	97	450	33.3	15.0	1935	1742	129
			600	33.9	20.4	2539	2285	125
			900	35.0	31.5	3605	3244	114
			1350	36.7	49.5	5361	4825	108
			1800	38.0	68.4	6899	6209	101
Décor Ultra Vero SE 18	BXRC-27H4000-C-7x-SE	97	585	33.4	19.5	2449	2204	125
			780	34.0	26.5	3209	2888	121
			1170	35.0	41.0	4686	4218	114
			1755	36.8	64.5	6742	6068	104
			2340	38.1	89.3	8648	7783	97
Décor Ultra Vero SE 18	BXRC-27H4000-D-7x-SE	97	525	27.7	14.6	1867	1680	128
			700	28.2	19.8	2427	2184	123
			1050	29.0	30.5	3504	3153	115
			1575	30.4	47.9	5005	4504	104
			2100	31.5	66.2	6371	5734	96

Notes for Table 3:

1. Alternate drive currents in Table 3 are provided for reference only and are not a guarantee of performance.
2. Bridgelux maintains a ± 7% tolerance on flux measurements.
3. Typical stabilized DC performance values are provided as reference only and not a guarantee of performance.

Performance at Commonly Used Drive Currents

Table 3: Product Performance at Commonly Used Drive Currents (continued)

Product	Part Number	CRI	Drive Current ¹ (mA)	Typical V _f T _c = 25°C (V)	Typical Power T _c = 25°C (W)	Typical Flux ² T _c = 25°C (lm)	Typical DC Flux ³ T _c = 85°C (lm)	Typical Efficacy T _c = 25°C (lm/W)
Décor Ultra Vero SE 18	BXRC-30H4000-B-7x-SE	97	450	33.3	15.0	2067	1860	138
			600	33.9	20.4	2712	2441	133
			900	35.0	31.5	3850	3465	122
			1350	36.7	49.5	5727	5154	116
			1800	38.0	68.4	7369	6632	108
Décor Ultra Vero SE 18	BXRC-30H4000-C-7x-SE	97	585	33.4	19.5	2616	2355	134
			780	34.0	26.5	3428	3085	129
			1170	35.0	41.0	5007	4506	122
			1755	36.8	64.5	7203	6483	112
			2340	38.1	89.3	9240	8316	104
Décor Ultra Vero SE 18	BXRC-30H4000-D-7x-SE	97	525	27.7	14.6	1994	1795	137
			700	28.2	19.8	2593	2334	131
			1050	29.0	30.5	3744	3369	123
			1575	30.4	47.9	5347	4813	112
			2100	31.5	66.2	6807	6126	103
Décor Food Vero SE 18	BXRC-17E4000-B-74-SE	80	450	33.3	15.0	1422	1280	95
			600	33.9	20.4	1866	1679	92
			900	35.0	31.5	2649	2384	84
			1350	36.7	49.5	3940	3546	80
			1800	38.0	68.4	5070	4563	74
Décor Food Vero SE 18	BXRC-17E4000-C-74-SE	80	585	33.4	19.5	1800	1620	92
			780	34.0	26.5	2358	2123	89
			1170	35.0	41.0	3445	3100	84
			1755	36.8	64.5	4955	4460	77
			2340	38.1	89.3	6356	5721	71
Décor Food Vero SE 18	BXRC-17E4000-D-74-SE	80	525	27.7	14.6	1372	1235	94
			700	28.2	19.8	1784	1606	90
			1050	29.0	30.5	2576	2318	85
			1575	30.4	47.9	3680	3312	77
			2100	31.5	66.2	4684	4216	71
Décor Food Vero SE 18	BXRC-25E4000-B-74-SE	80	450	33.3	15.0	2299	2069	153
			600	33.9	20.4	3016	2714	148
			900	35.0	31.5	4282	3853	136
			1350	36.7	49.5	6368	5731	129
			1800	38.0	68.4	8195	7375	120
Décor Food Vero SE 18	BXRC-25E4000-C-74-SE	80	585	33.4	19.5	2909	2618	149
			780	34.0	26.5	3812	3431	144
			1170	35.0	41.0	5568	5011	136
			1755	36.8	64.5	8010	7209	124
			2340	38.1	89.3	10274	9247	115
Décor Food Vero SE 18	BXRC-25E4000-D-74-SE	80	525	27.7	14.6	2218	1996	152
			700	28.2	19.8	2884	2595	146
			1050	29.0	30.5	4163	3747	137
			1575	30.4	47.9	5946	5352	124
			2100	31.5	66.2	7570	6813	114

Notes for Table 3:

1. Alternate drive currents in Table 3 are provided for reference only and are not a guarantee of performance.
2. Bridgelux maintains a ± 7% tolerance on flux measurements.
3. Typical stabilized DC performance values are provided as reference only and not a guarantee of performance.

Performance at Commonly Used Drive Currents

Table 3: Product Performance at Commonly Used Drive Currents (continued)

Product	Part Number	CRI	Drive Current ¹ (mA)	Typical V_f $T_c = 25^\circ\text{C}$ (V)	Typical Power $T_c = 25^\circ\text{C}$ (W)	Typical Flux ² $T_c = 25^\circ\text{C}$ (lm)	Typical DC Flux ³ $T_c = 85^\circ\text{C}$ (lm)	Typical Efficacy $T_c = 25^\circ\text{C}$ (lm/W)
Décor Specialty Vero SE 18	BXRC-56G4001-B-74-SE	90	450	33.3	15.0	2448	2203	163
			600	33.9	20.4	3211	2890	158
			900	35.0	31.5	4559	4103	145
			1350	36.7	49.5	6781	6102	137
			1800	38.0	68.4	8725	7853	127
Décor Specialty Vero SE 18	BXRC-56G4001-C-74-SE	90	585	33.4	19.5	3097	2788	159
			780	34.0	26.5	4059	3653	153
			1170	35.0	41.0	5928	5335	145
			1755	36.8	64.5	8528	7675	132
			2340	38.1	89.3	10939	9845	123
Décor Specialty Vero SE 18	BXRC-56G4001-D-74-SE	90	525	27.7	14.6	2361	2125	162
			700	28.2	19.8	3070	2763	155
			1050	29.0	30.5	4433	3989	146
			1575	30.4	47.9	6331	5698	132
			2100	31.5	66.2	8060	7254	122
Décor Food Vero SE 29	BXRC-17E10K0-B-74-SE	80	900	49.6	44.7	4209	3788	94
			1200	50.5	60.6	5554	4999	92
			1800	52.0	93.6	8033	7230	86
			2700	54.1	146.1	11844	10659	81
			3600	55.8	201.0	15270	13743	76
Décor Food Vero SE 29	BXRC-17E10K0-C-74-SE	80	855	66.2	56.6	5780	5202	102
			1140	67.3	76.7	7346	6611	96
			1710	69.4	118.7	10175	9157	86
			2565	72.1	185.0	14434	12990	78
			3420	74.4	254.6	18091	16282	71
Décor Food Vero SE 29	BXRC-17E10K0-D-74-SE	80	1050	35.4	37.2	3723	3350	100
			1400	36.2	50.7	4791	4312	95
			2100	37.6	78.9	6768	6091	86
			3150	39.5	124.4	6828	6145	55
			4200	41.2	173.0	9635	8672	56

Notes for Table 3:

1. Alternate drive currents in Table 3 are provided for reference only and are not a guarantee of performance.
2. Bridgelux maintains a $\pm 7\%$ tolerance on flux measurements.
3. Typical stabilized DC performance values are provided as reference only and not a guarantee of performance.

Performance at Commonly Used Drive Currents

Table 3: Product Performance at Commonly Used Drive Currents (continued)

Product	Part Number	CRI	Drive Current ¹ (mA)	Typical V _f T _c = 25°C (V)	Typical Power T _c = 25°C (W)	Typical Flux ² T _c = 25°C (lm)	Typical DC Flux ³ T _c = 85°C (lm)	Typical Efficacy T _c = 25°C (lm/W)
Décor Food Vero SE 29	BXRC-25E10K0-B-74-SE	80	900	49.6	44.7	6803	6123	152
			1200	50.5	60.6	8977	8079	148
			1800	52.0	93.6	12983	11685	139
			2700	54.1	146.1	19143	17229	131
			3600	55.8	201.0	24682	22213	123
Décor Food Vero SE 29	BXRC-25E10K0-C-74-SE	80	855	66.2	56.6	9342	8408	165
			1140	67.3	76.7	11874	10687	155
			1710	69.4	118.7	16446	14801	139
			2565	72.1	185.0	23330	20997	126
			3420	74.4	254.6	29242	26318	115
Décor Food Vero SE 29	BXRC-25E10K0-D-74-SE	80	1050	35.4	37.2	6017	5416	162
			1400	36.2	50.7	7744	6970	153
			2100	37.6	78.9	10940	9846	139
			3150	39.5	124.4	15574	14017	125
			4200	41.2	173.0	19629	17666	113
Décor Specialty Vero SE 29	BXRC-56G10K1-B-74-SE	90	900	49.6	44.7	7244	6520	162
			1200	50.5	60.6	9558	8602	158
			1800	52.0	93.6	13824	12442	148
			2700	54.1	146.1	20383	18344	140
			3600	55.8	201.0	26280	23652	131
Décor Specialty Vero SE 29	BXRC-56G10K1-C-74-SE	90	855	66.2	56.6	9947	8952	176
			1140	67.3	76.7	12643	11378	165
			1710	69.4	118.7	17510	15759	148
			2565	72.1	185.0	24840	22356	134
			3420	74.4	254.6	31135	28021	122
Décor Specialty Vero SE 29	BXRC-56G10K1-D-74-SE	90	1050	35.4	37.2	6407	5766	172
			1400	36.2	50.7	8245	7421	163
			2100	37.6	78.9	11648	10483	148
			3150	39.5	124.4	16582	14924	133
			4200	41.2	173.0	20900	18810	121

Notes for Table 3:

1. Alternate drive currents in Table 3 are provided for reference only and are not a guarantee of performance.
2. Bridgelux maintains a ± 7% tolerance on flux measurements.
3. Typical stabilized DC performance values are provided as reference only and not a guarantee of performance.

Electrical Characteristics

Table 4: Electrical Characteristics

Part Number	Nominal Drive Current ¹ (mA)	Forward Voltage Pulsed, T _c = 25°C (V) ^{1, 2, 3, 8}			Typical Coefficient of Forward Voltage ⁴ ΔV _f /ΔT _c (mV/°C)	Typical Thermal Resistance Junction to Case ^{5, 6} R _{j-c} (C/W)	Driver Selection Voltages ⁷ (V)	
		Minimum	Typical	Maximum			V _f Min. Hot T _c = 105°C (V)	V _f Max. Cold ⁴ T _c = -40°C (V)
BXRC-xxx100x-B-7x-SE	270	32.4	35.0	37.6	-16.1	0.49	31.1	38.7
	540	34.9	37.8	40.6	-16.1	0.57	33.6	41.6
BXRC-xxx100x-C-7x-SE	360	32.4	35.0	37.6	-16.1	0.37	31.1	38.7
	720	34.9	37.7	40.5	-16.1	0.43	33.6	41.6
BXRC-xxx100x-D-7x-SE	350	24.1	26.0	28.0	-11.8	0.49	23.1	28.7
	700	26.3	28.4	30.5	-11.8	0.57	25.3	31.3
BXRC-xxx200x-B-7x-SE	450	32.4	35.0	37.6	-14.3	0.28	31.2	38.6
	900	34.7	37.5	40.3	-14.3	0.35	33.5	41.2
BXRC-xxx200x-C-7x-SE	630	32.4	35.0	37.6	-14.3	0.20	31.2	38.6
	1260	34.9	37.8	40.6	-14.3	0.24	33.8	41.5
BXRC-xxx200x-D-7x-SE	500	29.4	31.8	34.2	-13.3	0.34	28.4	35.0
	1000	31.8	34.4	37.0	-13.3	0.41	30.8	37.9
BXRC-xxx400x-B-7x-SE	900	32.4	35.0	37.6	-14.9	0.15	31.2	38.6
	1800	35.2	38.0	40.9	-14.9	0.19	34.0	41.8
BXRC-xxx400x-C-7x-SE	1170	32.4	35.0	37.6	-14.9	0.11	31.2	38.6
	2340	35.3	38.1	41.0	-14.9	0.13	34.1	42.0
BXRC-xxx400x-D-7x-SE	1050	26.8	29.0	31.2	-12.2	0.16	25.8	32.0
	2100	29.2	31.5	33.9	-12.2	0.19	28.2	34.7
BXRC-xxx10Kx-B-7x-SE	1800	48.1	52.0	55.9	-24.9	0.06	46.1	57.5
	3600	51.7	55.8	60.0	-24.9	0.07	49.7	61.6
BXRC-xxx10Kx-C-7x-SE	1710	64.2	69.4	74.6	-33.2	0.04	61.5	76.8
	3420	68.8	74.4	80.0	-33.2	0.05	66.2	82.2
BXRC-xxx10Kx-D-7x-SE	2100	34.8	37.6	40.4	-17.4	0.06	33.4	41.6
	4200	38.1	41.2	44.3	-17.4	0.07	36.7	45.4

Notes for Table 4:

- Parts are tested in pulsed conditions, T_c = 25°C. Pulse width is 10ms.
- Voltage minimum and maximum are provided for reference only and are not a guarantee of performance.
- Bridgelux maintains a tester tolerance of ± 0.10V on forward voltage measurements.
- Typical coefficient of forward voltage tolerance is ± 0.1mV for nominal current.
- Thermal resistance values are based from test data of a 3000K 80 CRI product.
- Thermal resistance value was calculated using total electrical input power; optical power was not subtracted from input power. The thermal interface material used during testing is not included in the thermal resistance value.
- V_f min hot and max cold values are provided as reference only and are not guaranteed by test. These values are provided to aid in driver design and selection over the operating range of the product.
- This product has been designed and manufactured per IEC 62031:2014. This product has passed dielectric withstand voltage testing at 1160 V. The working voltage designated for the insulation is 80V d.c. The maximum allowable voltage across the array must be determined in the end product application.

Eye Safety

Table 5: Eye Safety Classification

Part Number	Drive Current (mA)	CCT ^{1,2}	
		2700K	3000K
BXRC-xxx100x-B-7x-SE	270	RG1	RG1
	405	RG1	RG1
	540	RG1	RG1
BXRC-xxx100x-C-7x-SE	360	RG1	RG1
	540	RG1	RG1
	720	RG1	RG1
BXRC-xxx100x-D-7x-SE	350	RG1	RG1
	525	RG1	RG1
	700	RG1	RG1
BXRC-xxx200x-B-7x-SE	450	RG1	RG1
	675	RG1	RG1
	900	RG1	RG1
BXRC-xxx200x-C-7x-SE	630	RG1	RG1
	945	RG1	RG1
	1260	RG1	RG1
BXRC-xxx200x-D-7x-SE	500	RG1	RG1
	750	RG1	RG1
	1000	RG1	RG1
BXRC-xxx400x-B-7x-SE	900	RG1	RG1
	1350	RG1	RG1
	1800	RG1	RG1
BXRC-xxx400x-C-7x-SE	1170	RG1	RG1
	1755	RG1	RG1
	2340	RG1	RG1
BXRC-xxx400x-D-7x-SE	1050	RG1	RG1
	1575	RG1	RG1
	2100	RG1	RG1

Notes for Table 5:

1. Eye safety classification for the use of Bridgelux Vero Series LED arrays is in accordance with specification IEC/TR 62778: Application of IEC 62471 for the assessment of blue light hazard to light sources and luminaires.
2. Please contact your Bridgelux sales representative for $E_{l,v}$ values at specific drive currents and CCTs not listed.

Absolute Maximum Ratings

Table 6: Maximum Ratings

Parameter	Maximum Rating		
LED Junction Temperature	125°C		
Storage Temperature	-40°C to +105°C		
Operating Case Temperature ¹	105°C		
	BXRC-xxx100x-B-7x-SE	BXRC-xxx100x-C-7x-SE	BXRC-xxx100x-D-7x-SE
Maximum Drive Current ²	540mA	720mA	700mA
Maximum Peak Pulsed Drive Current ³	770mA	1030mA	1000mA
Maximum Reverse Voltage ⁴	-60V	-60V	-45V

	BXRC-xxx200x-B-7x-SE	BXRC-xxx200x-C-7x-SE	BXRC-xxx200x-D-7x-SE
Maximum Drive Current ²	900mA	1260mA	1000mA
Maximum Peak Pulsed Drive Current ³	1290mA	1800mA	1430mA
Maximum Reverse Voltage ⁴	-60V	-60V	-55V

	BXRC-xxx400x-B-7x-SE	BXRC-xxx400x-C-7x-SE	BXRC-xxx400x-D-7x-SE
Maximum Drive Current ²	1800mA	2340mA	2100mA
Maximum Peak Pulsed Drive Current ³	2570mA	3340mA	3000mA
Maximum Reverse Voltage ⁴	-60V	-60V	-50V

	BXRC-xxx10Kx-B-7x-SE	BXRC-xxx10Kx-C-7x-SE	BXRC-xxx10Kx-D-7x-SE
Maximum Drive Current ²	3600mA	3420mA	4200mA
Maximum Peak Pulsed Drive Current ³	5140mA	4890mA	6000mA
Maximum Reverse Voltage ⁴	-90V	-120V	-65V

Notes for Table 6:

1. For IEC 62717 requirement, please contact Bridgelux Sales Support.
2. Arrays may be driven at higher currents however lumen maintenance may be reduced.
3. Bridgelux recommends a maximum duty cycle of 10% and pulse width of 20ms when operating LED Arrays at the maximum peak pulsed current specified. Maximum peak pulsed current indicate values where the LED array can be driven without catastrophic failures.
4. Light emitting diodes are not designed to be driven in reverse voltage and will not produce light under this condition. Maximum rating provided for reference only.

Performance Curves

Figure 1: Vero SE 10B Drive Current vs. Forward Voltage ($T_j=T_c=25^\circ\text{C}$)

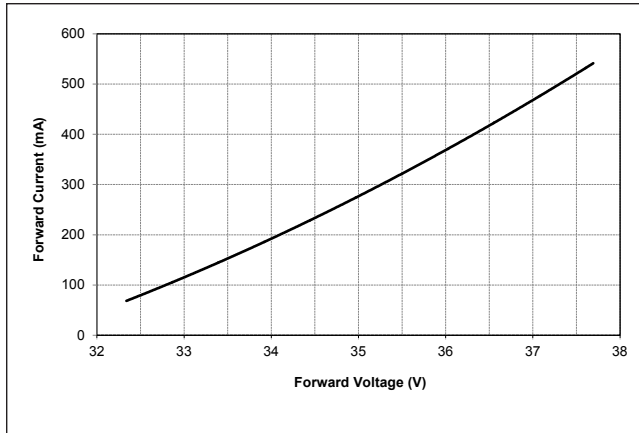

Figure 2: Vero SE 10C Drive Current vs. Forward Voltage ($T_j=T_c=25^\circ\text{C}$)

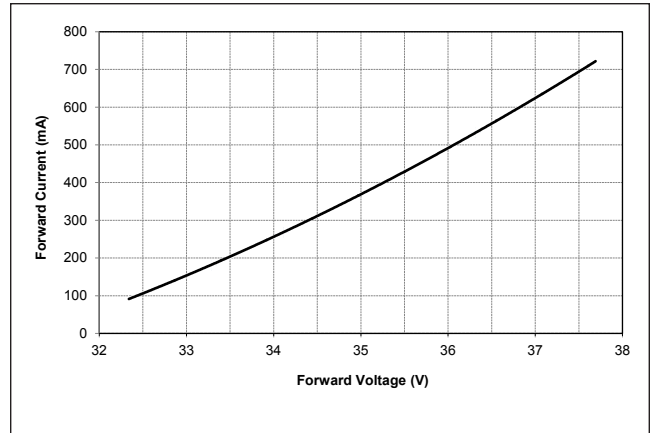

Figure 3: Vero SE 10D Drive Current vs. Forward Voltage ($T_j=T_c=25^\circ\text{C}$)

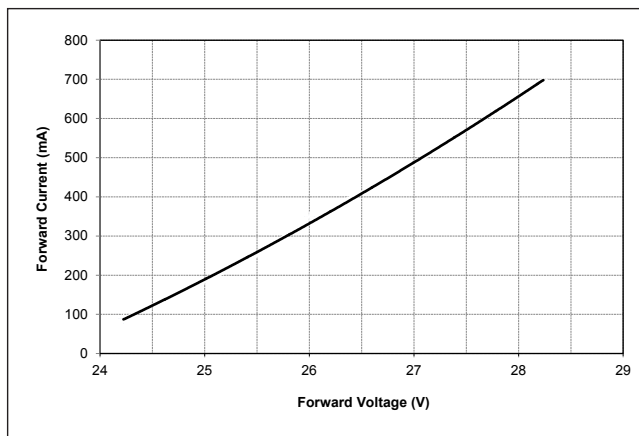

Figure 4: Vero SE 13B Drive Current vs. Forward Voltage ($T_j=T_c=25^\circ\text{C}$)

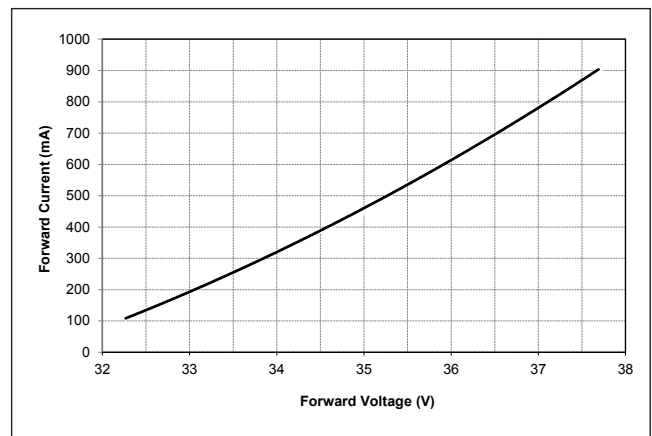

Figure 5: Vero SE 13C Drive Current vs. Forward Voltage ($T_j=T_c=25^\circ\text{C}$)

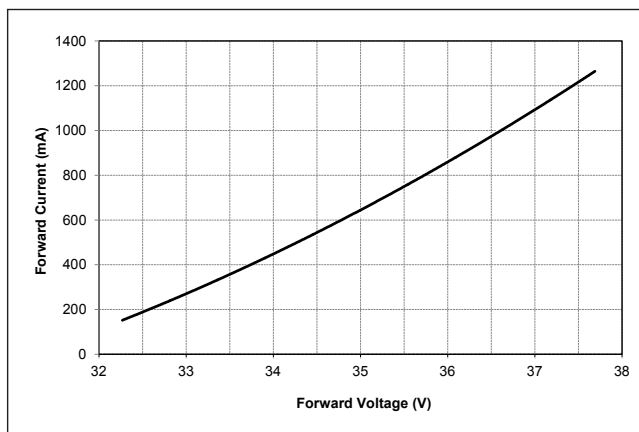
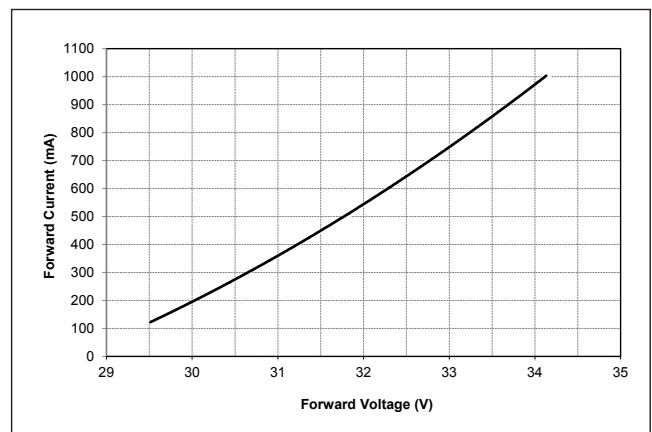

Figure 6: Vero SE 13D Drive Current vs. Forward Voltage ($T_j=T_c=25^\circ\text{C}$)



Performance Curves

Figure 7: Vero SE 18B Drive Current vs. Forward Voltage ($T_j=T_c=25^\circ\text{C}$)

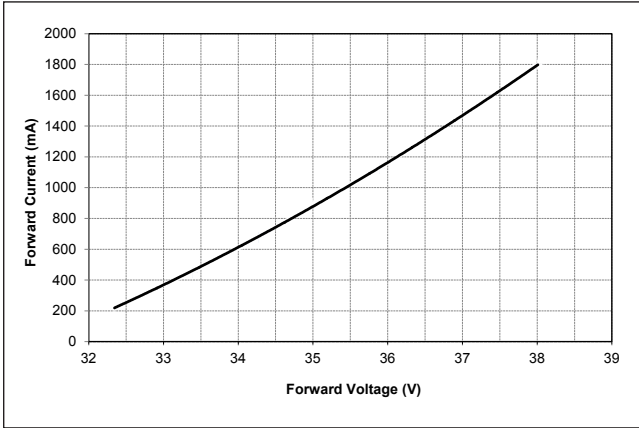

Figure 8: Vero SE 18C Drive Current vs. Forward Voltage ($T_j=T_c=25^\circ\text{C}$)

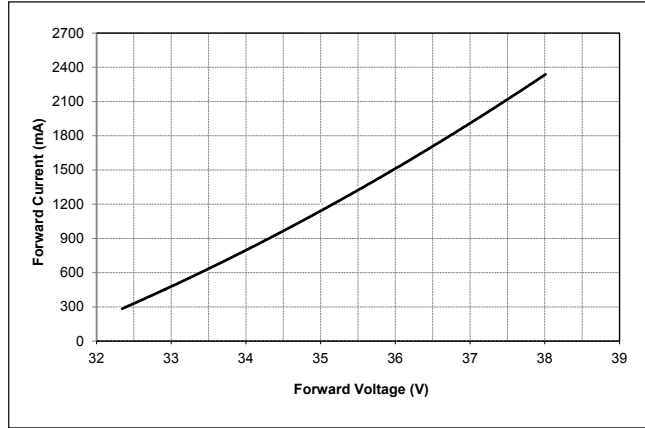

Figure 9: Vero SE 18D Drive Current vs. Forward Voltage ($T_j=T_c=25^\circ\text{C}$)

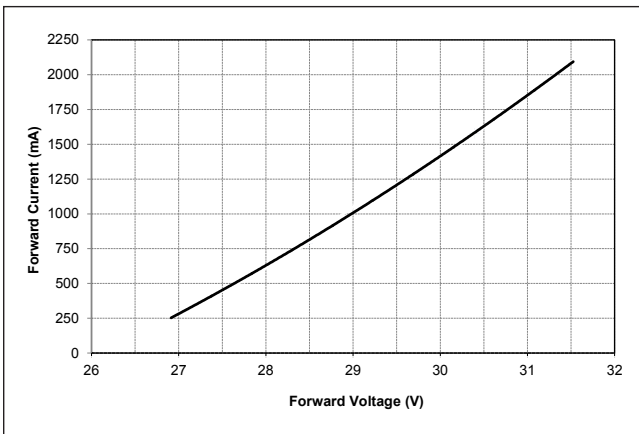

Figure 10: Vero SE 29B Drive Current vs. Forward Voltage ($T_j=T_c=25^\circ\text{C}$)

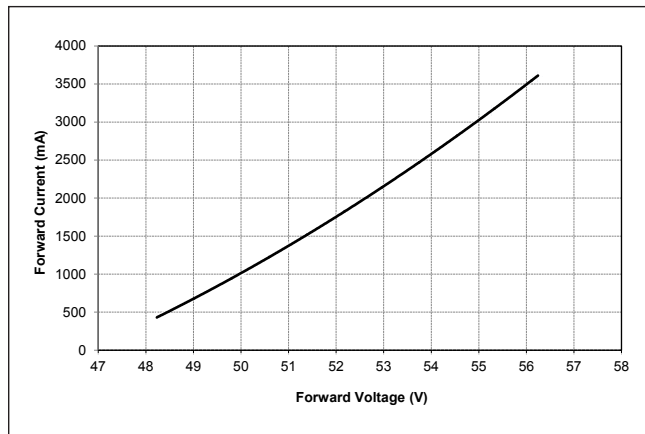

Figure 11: Vero SE 29C Drive Current vs. Forward Voltage ($T_j=T_c=25^\circ\text{C}$)

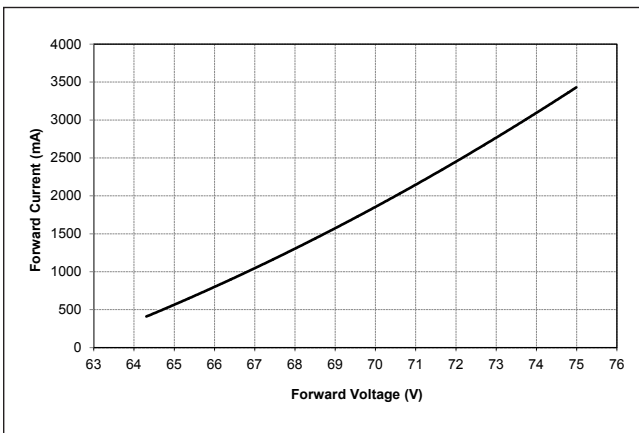
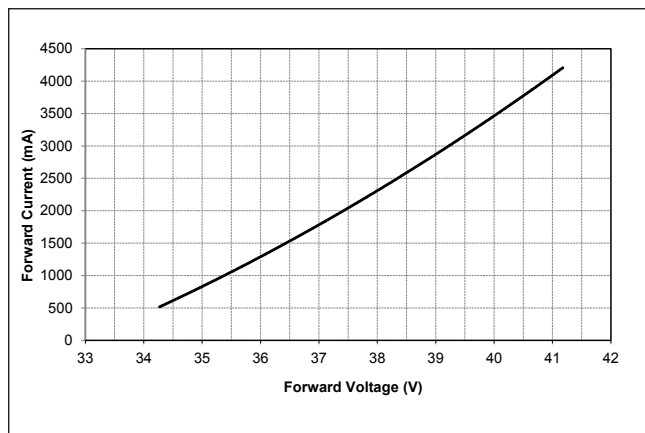

Figure 12: Vero SE 29D Drive Current vs. Forward Voltage ($T_j=T_c=25^\circ\text{C}$)



Performance Curves

Figure 13: Vero SE 10B Typical Relative Luminous Flux vs. Drive Current

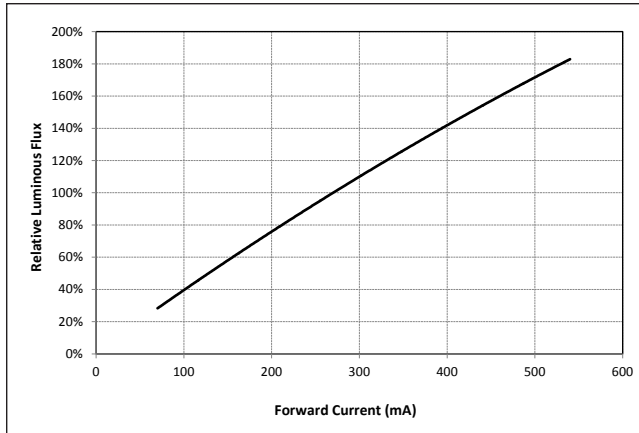

Figure 14: Vero SE 10C Typical Relative Luminous Flux vs. Drive Current

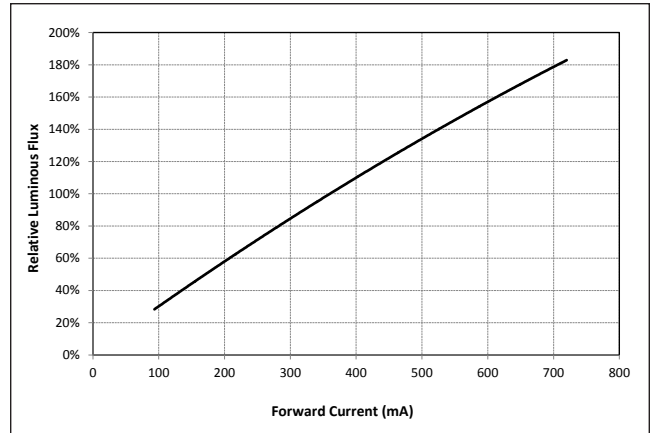

Figure 15: Vero SE 10D Typical Relative Luminous Flux vs. Drive Current

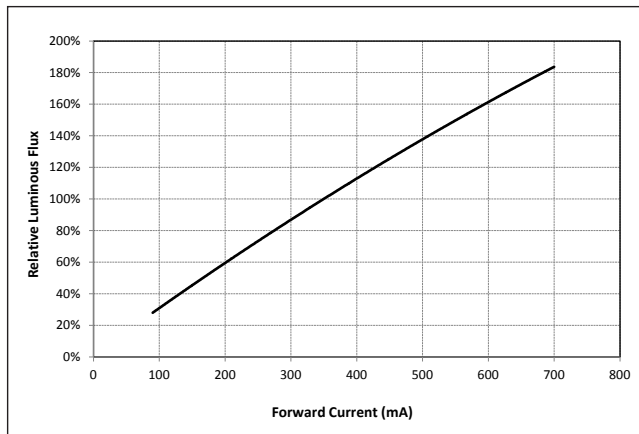

Figure 16: Vero SE 13B Typical Relative Luminous Flux vs. Drive Current

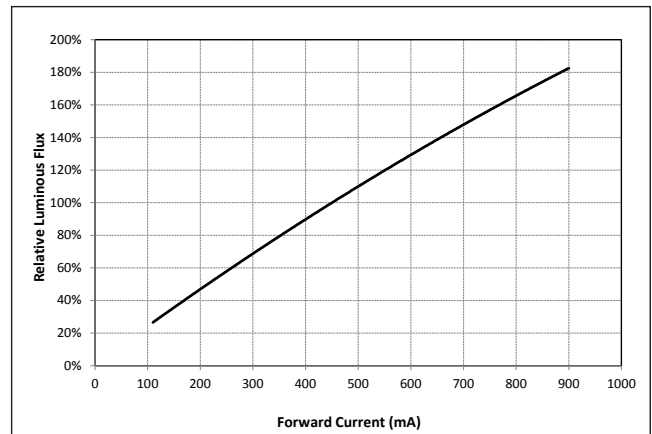

Figure 17: Vero SE 13C Typical Relative Luminous Flux vs. Drive Current

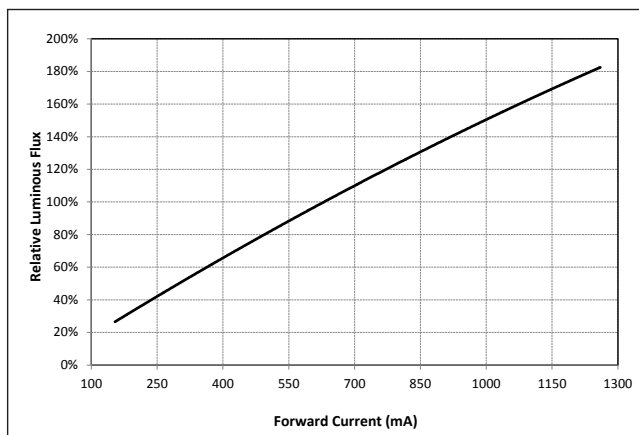
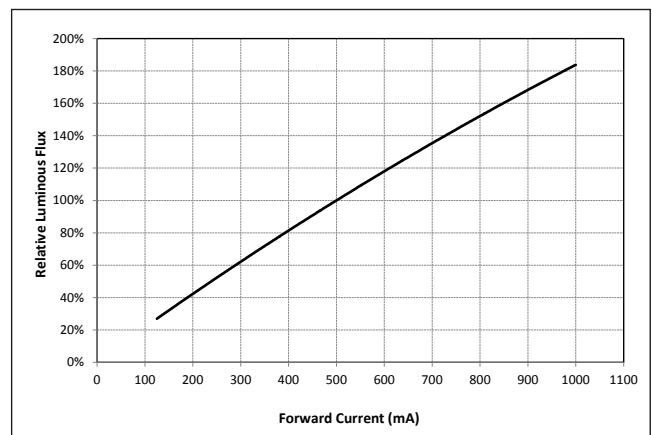

Figure 18: Vero SE 13D Typical Relative Luminous Flux vs. Drive Current



Performance Curves

Figure 19: Vero SE 18B Typical Relative Luminous Flux vs. Drive Current

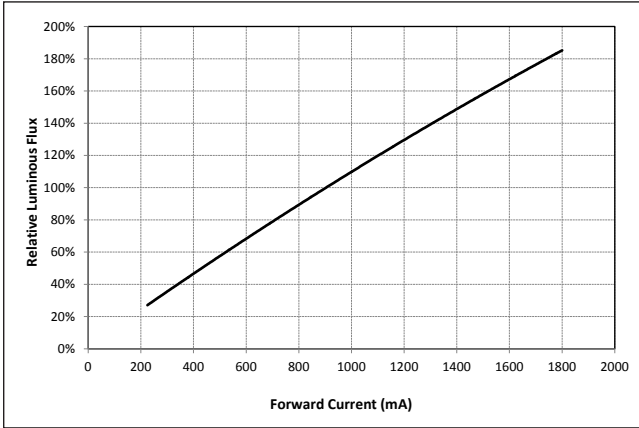

Figure 20: Vero SE 18C Typical Relative Luminous Flux vs. Drive Current

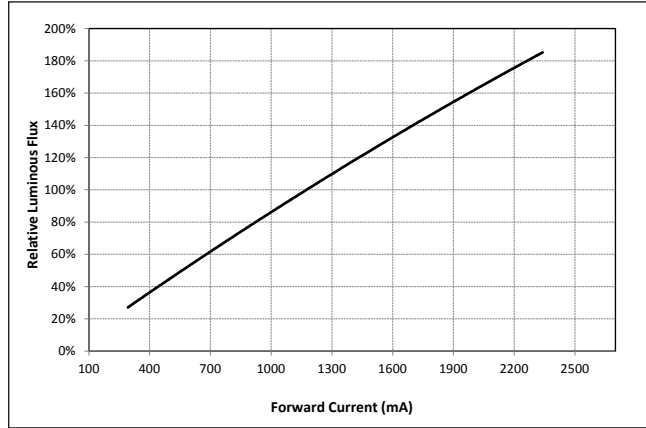

Figure 21: Vero SE 18D Typical Relative Luminous Flux vs. Drive Current

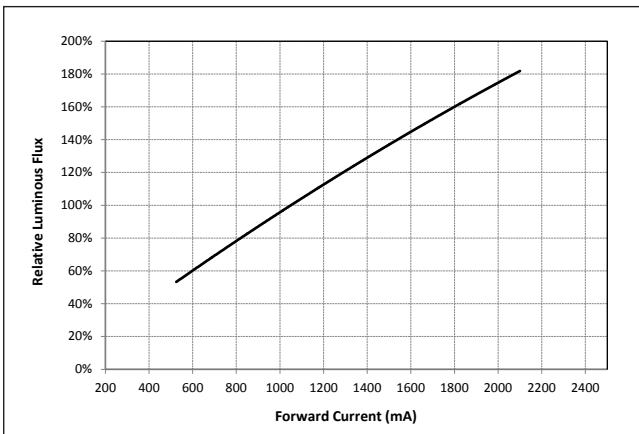

Figure 22: Vero SE 29B Typical Relative Luminous Flux vs. Drive Current

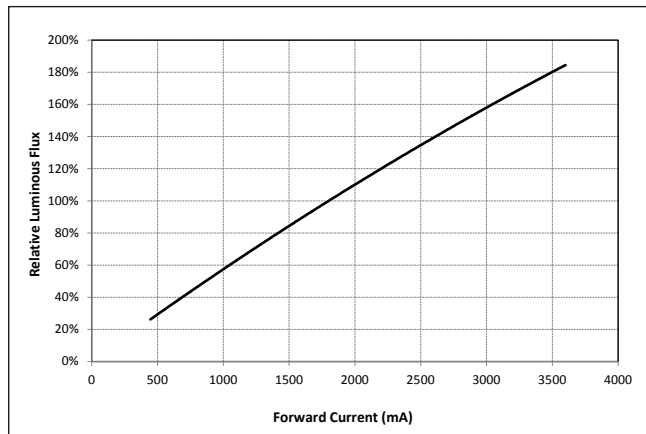

Figure 23: Vero SE 29C Typical Relative Luminous Flux vs. Drive Current

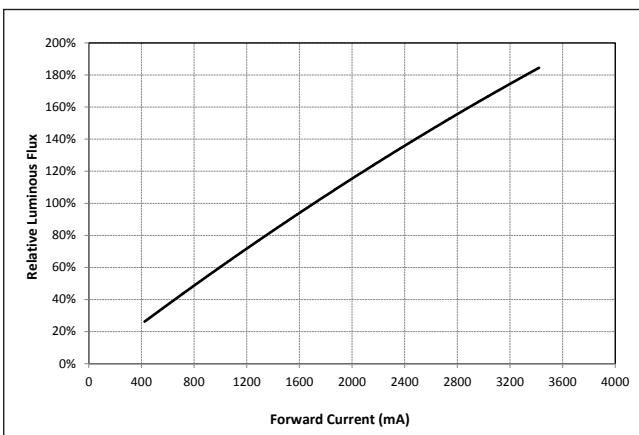
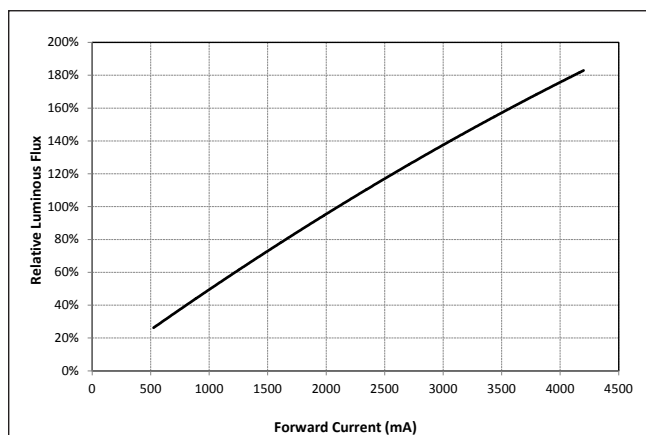

Figure 24: Vero SE 29D Typical Relative Luminous Flux vs. Drive Current



Performance Curves

Figure 25: Vero SE 10 Typical DC Flux vs. Case Temperature

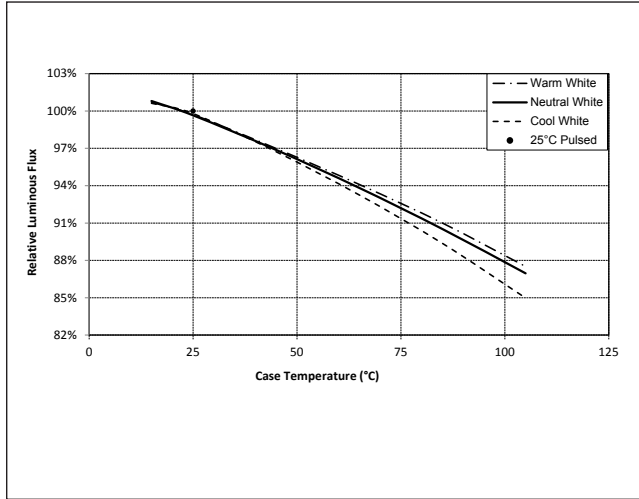

Figure 26: Vero SE 13 Typical DC Flux vs. Case Temperature

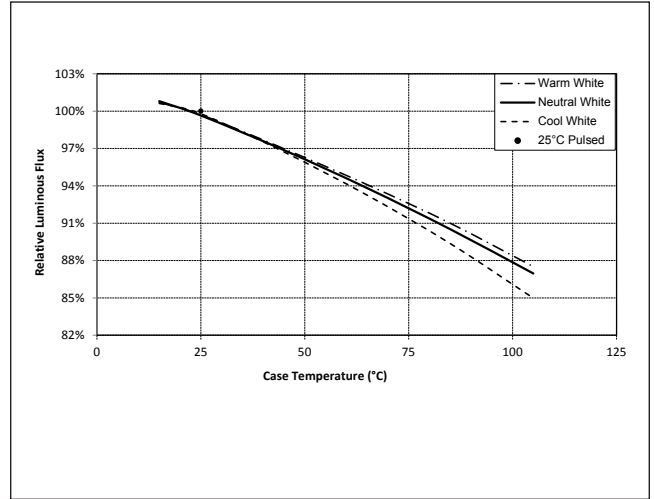

Figure 27: Vero SE 18 Typical DC Flux vs. Case Temperature

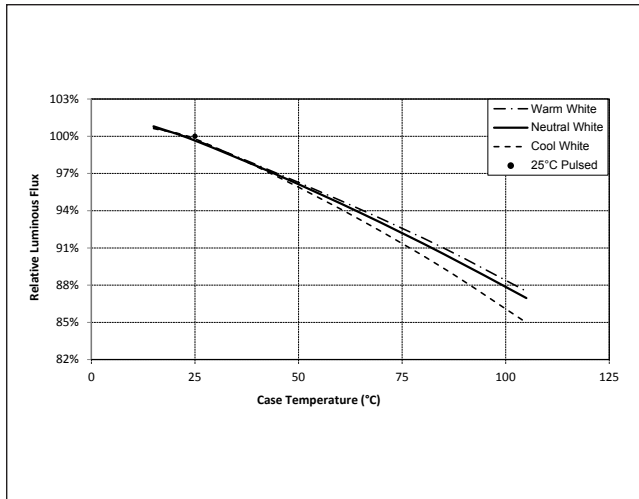
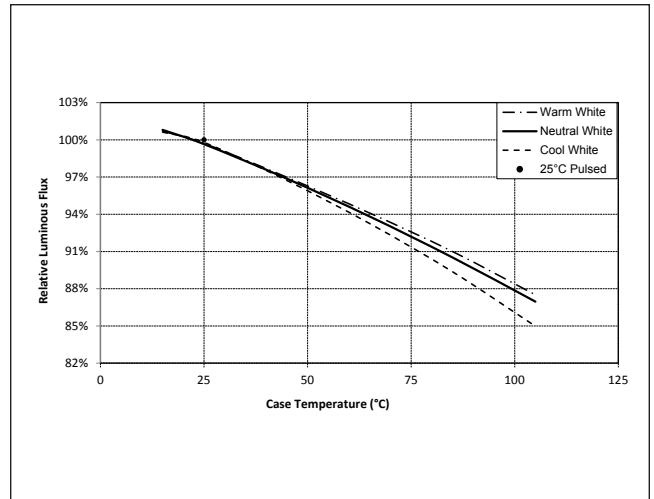

Figure 28: Vero SE 29 Typical DC Flux vs. Case Temperature



Note for Figures 25-28:

1. Flux measurements taken under DC conditions.
2. Characteristics shown for warm white based on 3000K and 80 CRI.
3. Characteristics shown for neutral white based on 4000K and 80 CRI.
4. Characteristics shown for cool white based on 5000K and 70 CRI.
5. For other color SKUs, the shift in color will vary. Please contact your Bridgelux Sales Representative for more information.

Performance Curves

Figure 29: 1750K Color Shift vs. Case Temperature¹

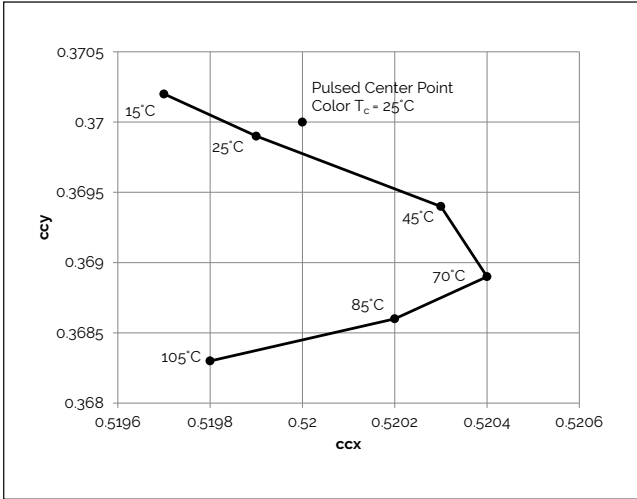

Figure 30: 2500K Color Shift vs. Case Temperature¹

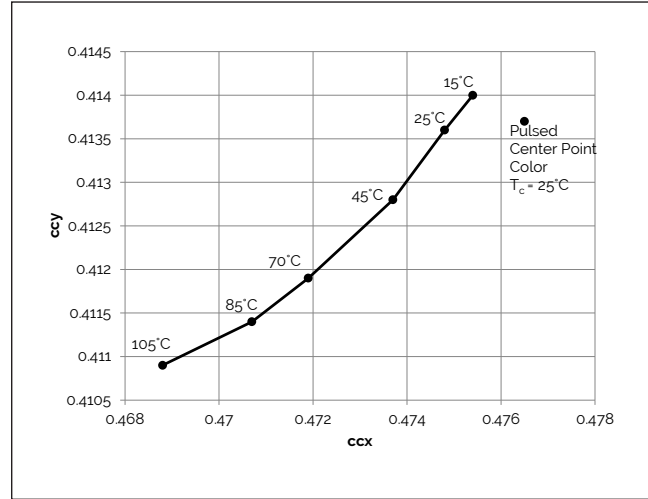

Figure 31: 2700K Color Shift vs. Case Temperature¹

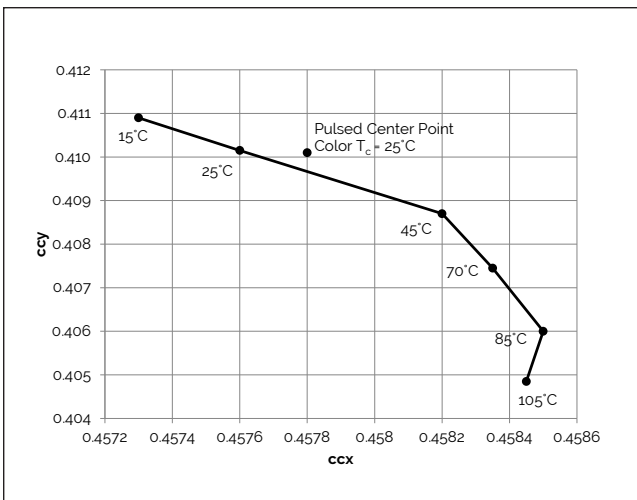
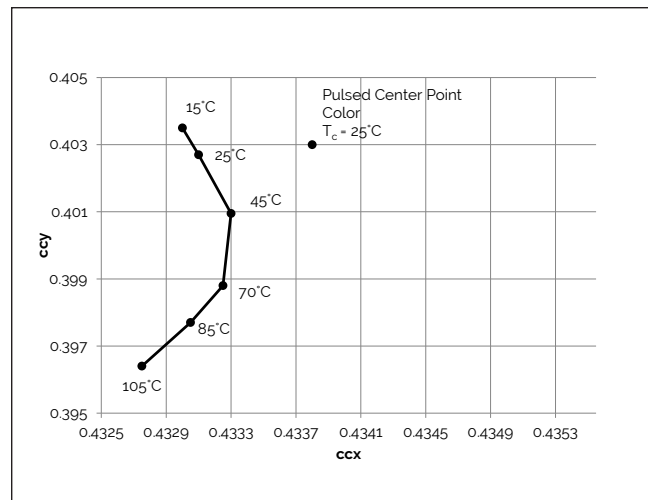

Figure 32: 3000K Color Shift vs. Case Temperature¹



Note for Figures 29-32:

1. Measurements made under DC test conditions at the nominal drive current.
2. Typical color shift is shown with a tolerance of ± 0.002 .

Performance Curves

Figure 33: 5600K Color Shift vs. Case Temperature¹

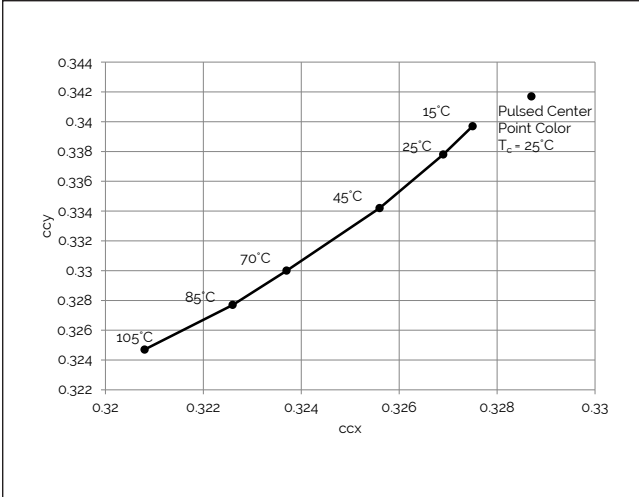

Note for Figure 33:

- 1. Measurements made under DC test conditions at the nominal drive current.
- 2. Typical color shift is shown with a tolerance of ±0.002.

Typical Radiation Pattern

Figure 34: Typical Spatial Radiation Pattern

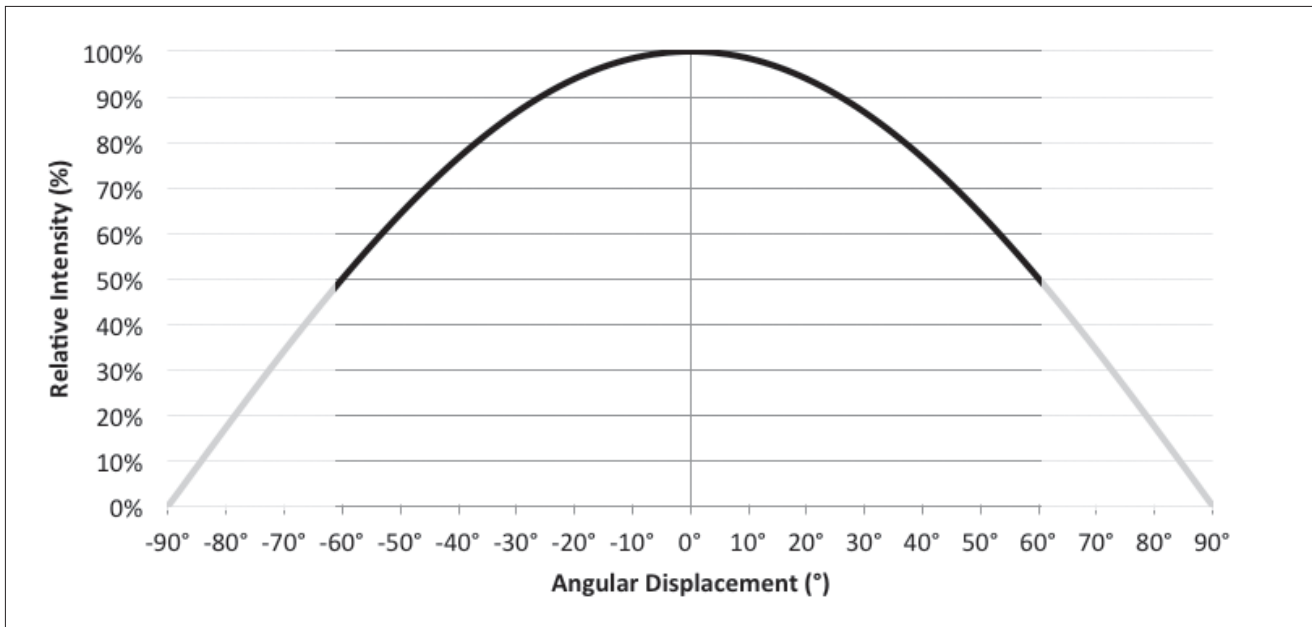

Notes for Figure 34:

1. Typical viewing angle is 120°.
2. The viewing angle is defined as the off axis angle from the centerline where I_v is $\frac{1}{2}$ of the peak value.

Figure 35: Typical Polar Radiation Pattern

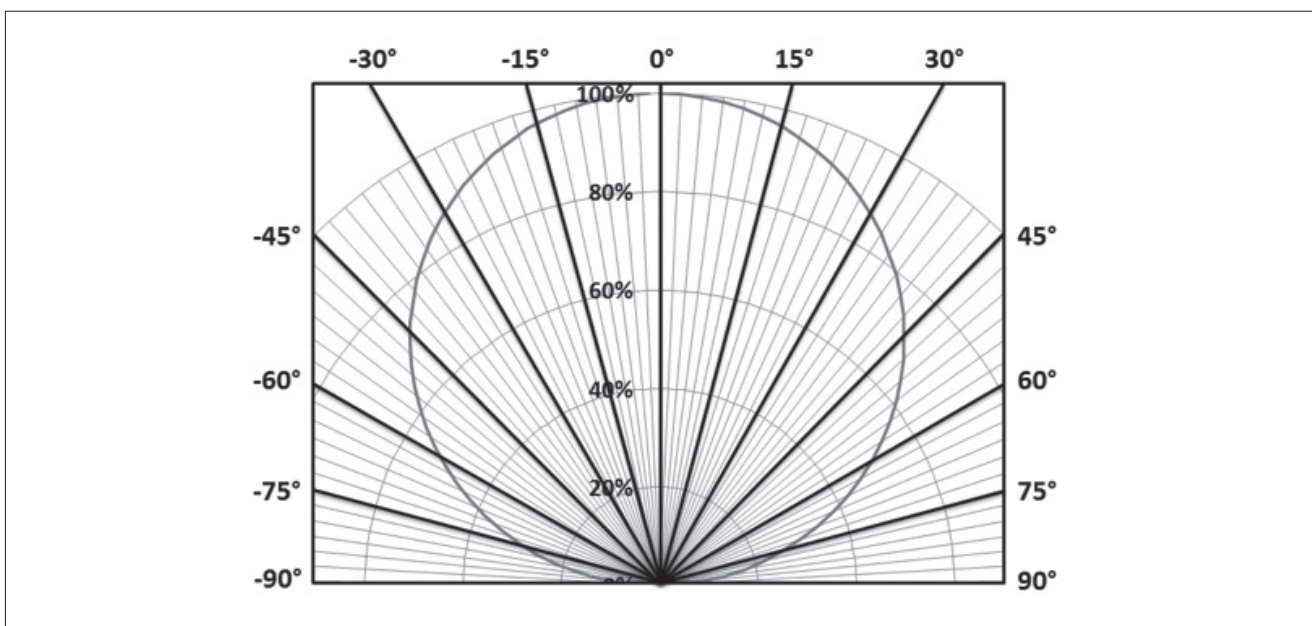

Typical Color Spectrum

97 CRI- Wavelength & CRI Characteristics at Drive Current, $T_c=25^\circ\text{C}$

The high CRI light delivered by the Bridgelux Décor products reproduces colors faithfully compared with natural light. Figure 36 displays the spectral curve of Décor.

Table 6 compares CRI R values of Décor to other light sources. The typical overall CRI (Ra) of 97 results in excellent color representation - especially for colors which the human eye is particularly sensitive.

Décor delivers high typical values of R9 (98) and R15 (98). These are important attributes for the perception of realistic colors. R9 enhances red colors and R15 enables realistic rendering of human skin tones.

Figure 36: Typical Color Spectrum

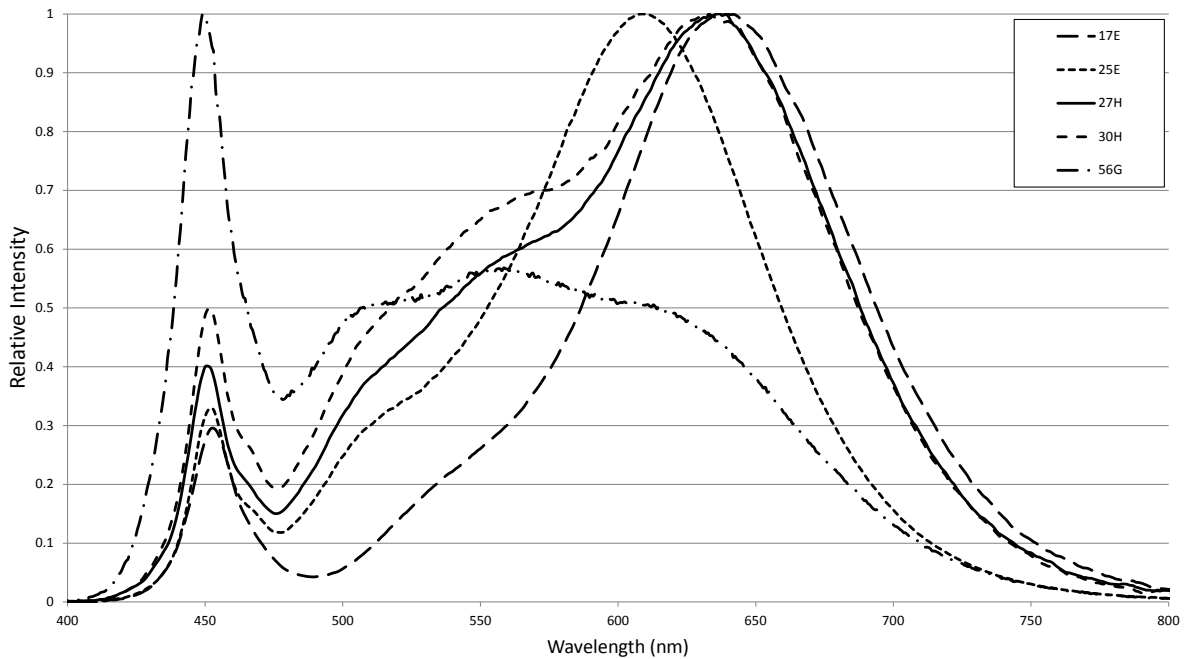
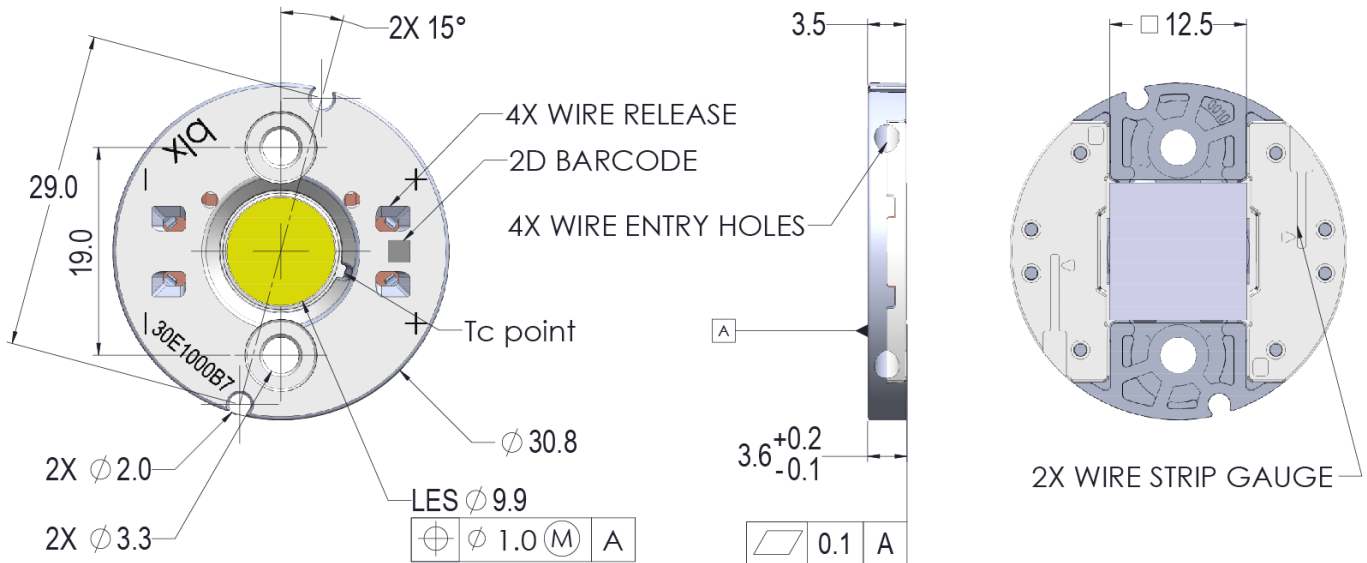

Table 6: CRI Spectra for Décor Ultra Products vs. Alternative Light Sources

Light Source	Ra	R1	R2	R3	R4	R5	R6	R7	R8	R9	R10	R11	R12	R13	R14	R15
Bridgelux Décor Ultra	97	97	100	96	96	98	98	99	98	98	99	92	87	98	97	98
Typical Halogen	98	98	99	99	99	98	98	99	97	92	97	98	97	98	99	97
Typical Metal Halide	82	90	94	69	82	81	81	87	71	27	59	62	55	93	78	88
Typical Compact Fluorescent	87	91	93	86	91	89	90	88	70	17	76	91	81	93	92	81

Mechanical Dimensions

Figure 37: Drawing for Vero SE 10 LED Array



Notes for Figure 37:

1. Drawings are not to scale.
2. Drawing dimensions are in millimeters.
3. Unless otherwise specified, tolerances are ± 0.10 mm.
4. Mounting slots (2X) are for M2.5 screws.
5. Bridgelux recommends two tapped holes for mounting screws with 19.0 ± 0.10 mm center-to-center spacing.
6. Screws with flat shoulders (pan, dome, button, round, truss, mushroom) provide optimal torque control. Do NOT use flat, countersink, or raised head screws.
7. The optical center of the LED Array is nominally defined by the mechanical center of the array to a tolerance of ± 0.2 mm.
8. Bridgelux maintains a flatness of 0.10mm across the mounting surface of the array.

Mechanical Dimensions

Figure 38: Drawing for Vero SE 13 LED Array

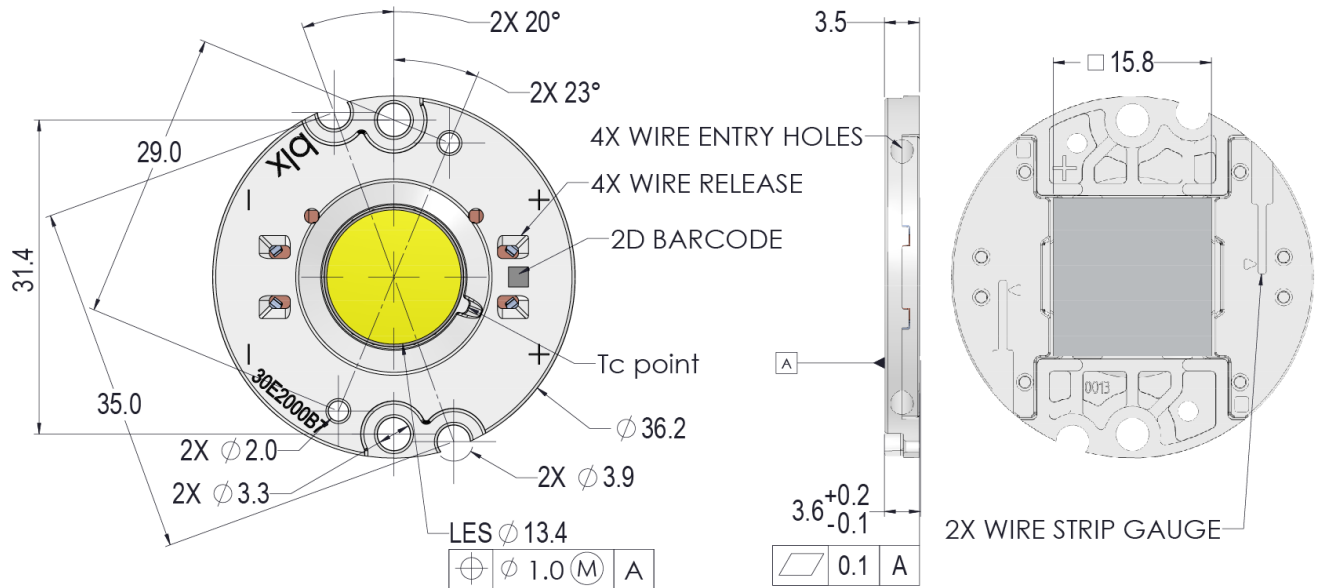

Notes for Figure 38:

1. Drawings are not to scale.
2. Drawing dimensions are in millimeters.
3. Unless otherwise specified, tolerances are $\pm 0.10\text{mm}$.
4. Mounting holes (2X) are for M2.5 screws.
5. Bridgelux recommends two tapped holes for mounting screws with $31.4 \pm 0.10\text{mm}$ center-to-center spacing.
6. Screws with flat shoulders (pan, dome, button, round, truss, mushroom) provide optimal torque control. Do NOT use flat, countersink, or raised head screws.
7. The optical center of the LED Array is nominally defined by the mechanical center of the array to a tolerance of $\pm 0.2\text{mm}$.
8. Bridgelux maintains a flatness of 0.10mm across the mounting surface of the array.

Mechanical Dimensions

Figure 39: Drawing for Vero SE 18 LED Array

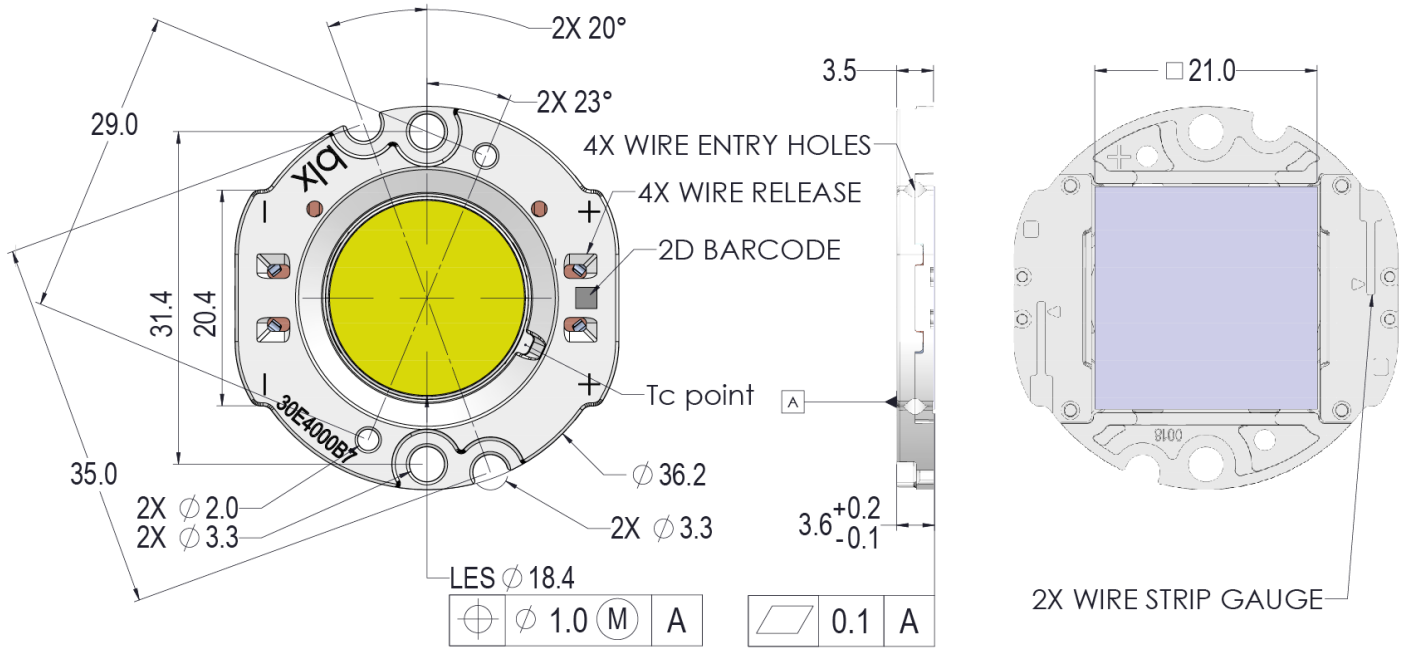

Notes for Figure 39:

1. Drawings are not to scale.
2. Drawing dimensions are in millimeters.
3. Unless otherwise specified, tolerances are $\pm 0.10\text{mm}$.
4. Mounting holes (2X) are for M2.5 screws.
5. Bridgelux recommends two tapped holes for mounting screws with $31.4 \pm 0.10\text{mm}$ center-to-center spacing.
6. Screws with flat shoulders (pan, dome, button, round, truss, mushroom) provide optimal torque control. Do NOT use flat, countersink, or raised head screws.
7. The optical center of the LED Array is nominally defined by the mechanical center of the array to a tolerance of $\pm 0.2\text{mm}$.
8. Bridgelux maintains a flatness of 0.10mm across the mounting surface of the array.

Mechanical Dimensions

Figure 40: Drawing for Vero SE 29 LED Array

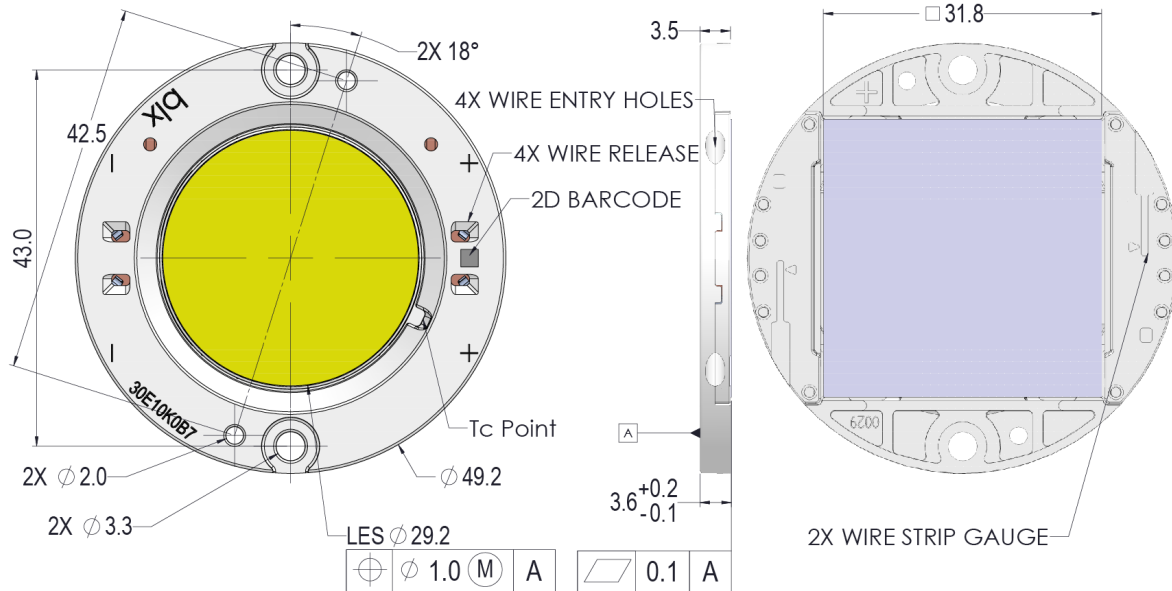

Notes for Figure 40:

1. Drawings are not to scale.
2. Drawing dimensions are in millimeters.
3. Unless otherwise specified, tolerances are ± 0.10 mm.
4. Mounting holes (4X) are for M3 screws.
5. Bridgelux recommends two tapped holes for mounting screws with 43.0 ± 0.10 mm center-to-center spacing.
6. Screws with flat shoulders (pan, dome, button, round, truss, mushroom) provide optimal torque control. Do NOT use flat, countersink, or raised head screws.
7. The optical center of the LED Array is nominally defined by the mechanical center of the array to a tolerance of ± 0.2 mm.
8. Bridgelux maintains a flatness of 0.10mm across the mounting surface of the array.

Color Binning Information

Figure 41: Graph of Warm and Neutral White Test Bins in xy Color Space

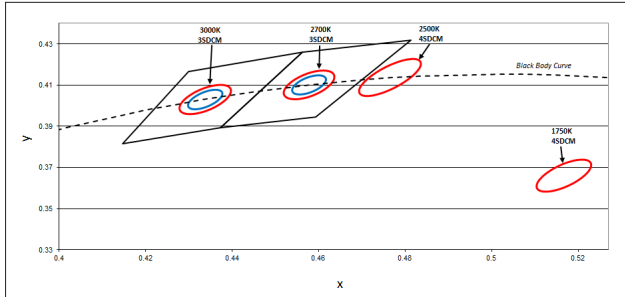

Note: Pulsed Test Conditions, $T_c = 25^\circ\text{C}$

Table 7: Warm White xy Bin Coordinates and Associated Typical CCT

Bin Code	1750K	2500K	2700K	3000K
ANSI Bin (for reference only)	-	-	(2580K - 2870K)	(2870K - 3220K)
3 (3 SDCM)	-	-	(2651K - 2794K)	(2968K - 3136K)
2 (2 SDCM)	-	-	(2674K - 2769K)	(2995K - 3107K)
Center Point (x,y)	(0.5167, 0.336)	(0.4765, 0.4137)	(0.4578, 0.4101)	(0.4338, 0.403)

Figure 42: Graph of Cool White Test Bins in xy Color Space

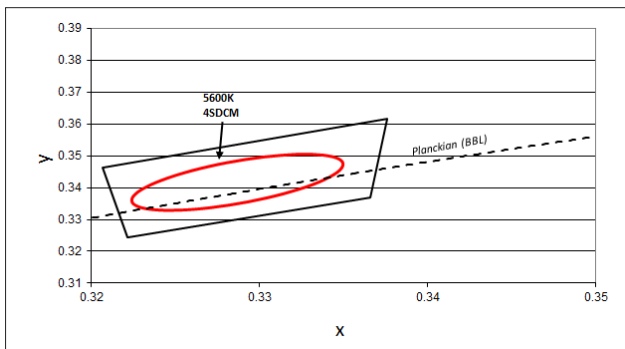

Note: Pulsed Test Conditions, $T_c = 25^\circ\text{C}$

Table 8: Cool White xy Bin Coordinates and Associated Typical CCT (product is hot targeted to $T_c = 85^\circ\text{C}$)

Bin Code	5600K
ANSI Bin (for reference only)	(5310K - 6020K)
4 (4 SDCM)	(5475K - 5830K)
Center Point (x,y)	(0.3293, 0.3423)

Packaging and Labeling

Figure 16: Drawing for Vero SE 10 Packaging Tray

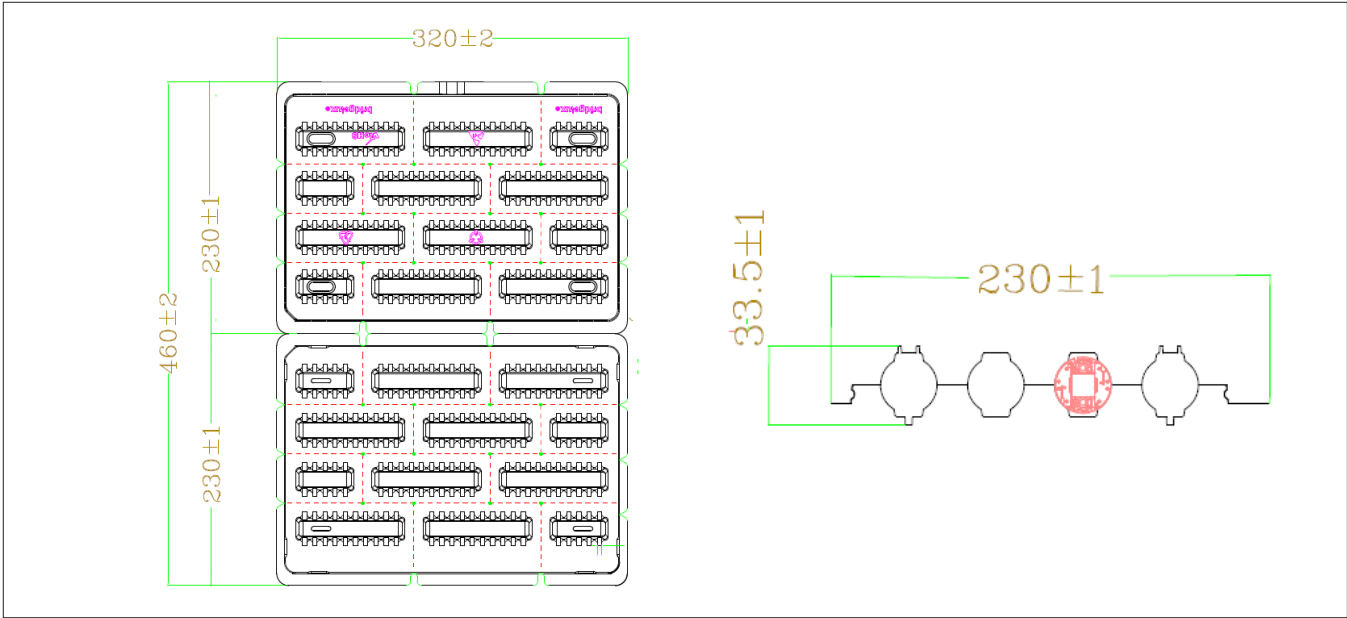

Notes for Figure 16:

1. Dimensions are in millimeters.
2. Drawings are not to scale.

Figure 17: Drawing for Vero SE 13 Packaging Tray

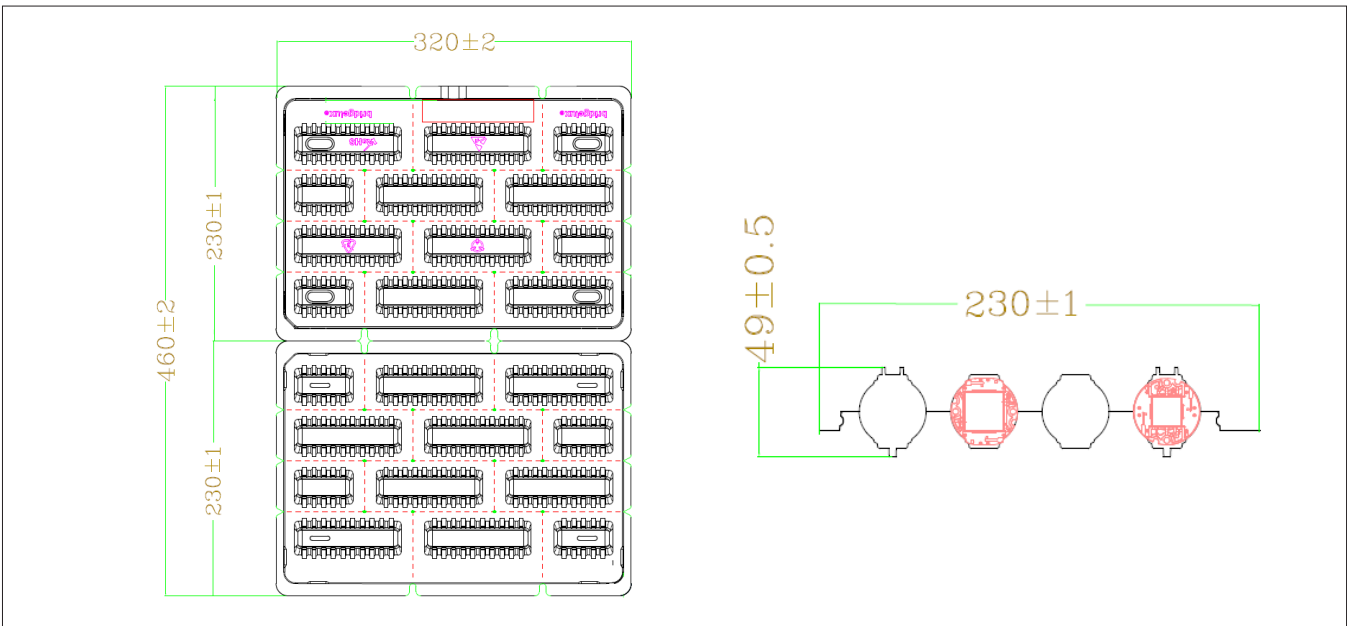

Notes for Figure 17:

1. Dimensions are in millimeters.
2. Drawings are not to scale.

Packaging and Labeling

Figure 18: Drawing for Vero SE 18 Packaging Tray

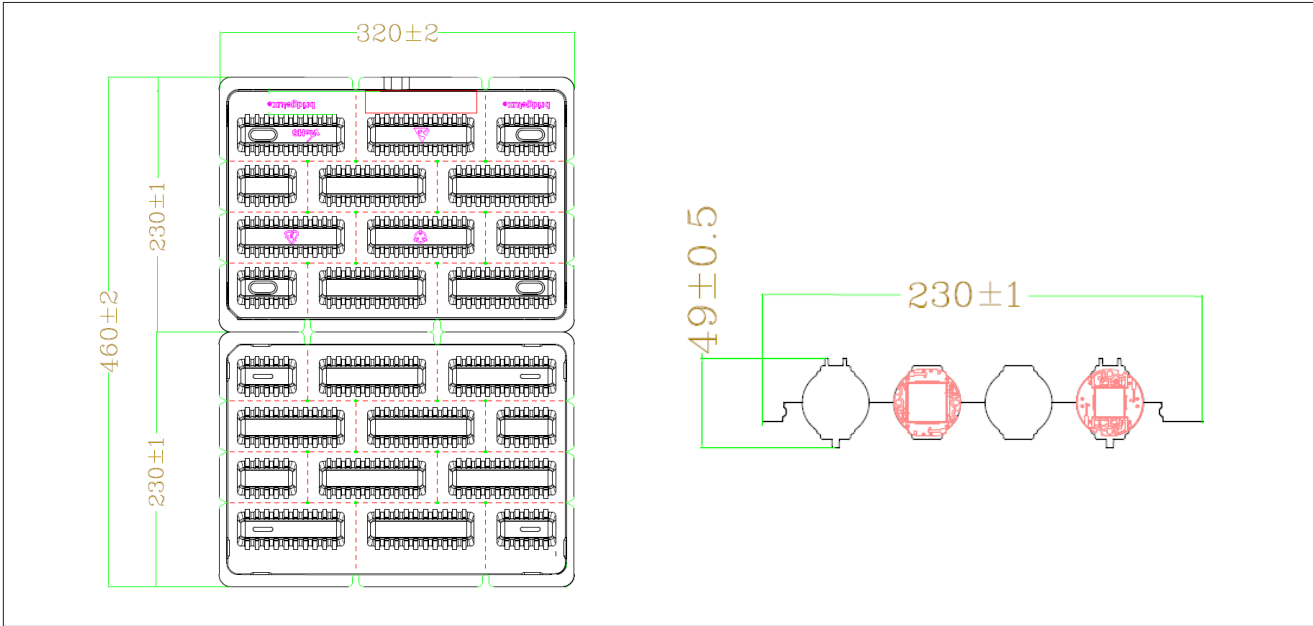

Notes for Figure 18:

1. Dimensions are in millimeters.
2. Drawings are not to scale.

Figure 19: Drawing for Vero SE 29 Packaging Tray

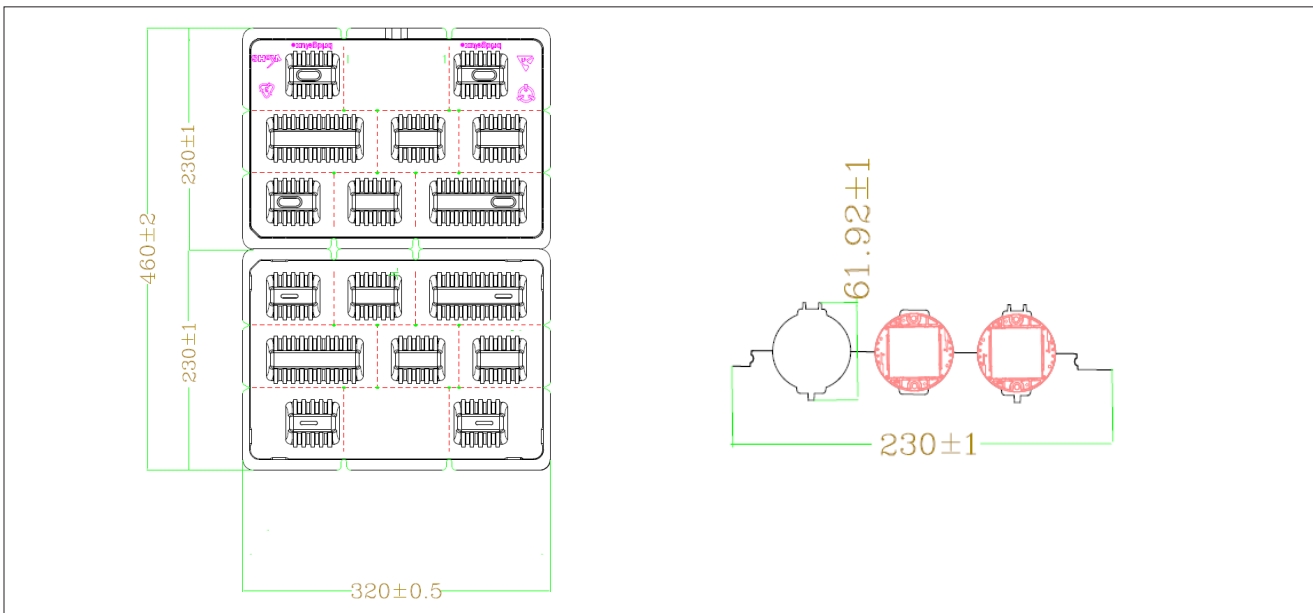

Notes for Figure 19:

1. Dimensions are in millimeters.
2. Drawings are not to scale.

Packaging and Labeling

Figure 20: Vero SE Packaging and Labeling

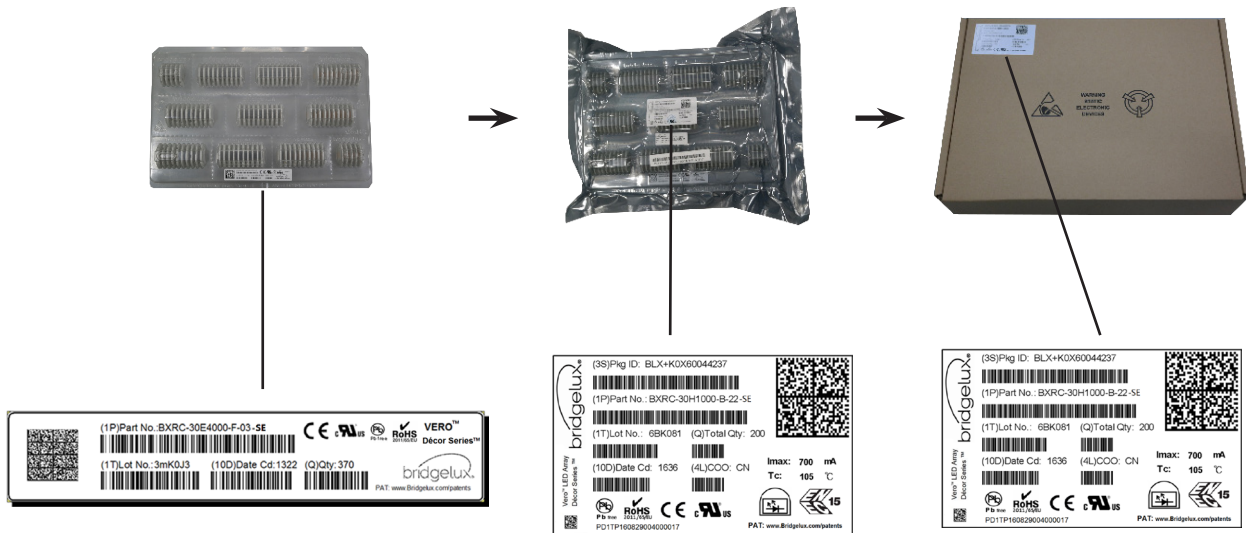

Notes for Figure 17:

1. Each tray holds 100 COBs for Vero SE 10, 100 COBs for Vero SE 13, 100 COBs for Vero SE 18, and 50 COBs for Vero SE 29.
2. Each tray is vacuum sealed in an antistatic bag and placed in its own box.
3. Each tray, bag and box is to be labeled as shown above.

Figure 21: Vero SE Product Labeling

Bridgelux COB arrays have laser markings on the back side of the substrate to help with product identification. In addition to the product identification markings, Bridgelux COB arrays also contain markings for internal Bridgelux manufacturing use only. The image below shows which markings are for customer use and which ones are for Bridgelux internal use only. The Bridgelux internal manufacturing markings are subject to change without notice, however these will not impact the form, function or performance of the COB array.



Design Resources

Optical Source Models

Optical source models and ray set files are available for all Bridgelux products. For a list of available formats, visit www.bridgelux.com.

3D CAD Models

Three dimensional CAD models depicting the product outline of all Bridgelux Vero LED arrays are available in both IGS and STEP formats. Please contact your Bridgelux sales representative for assistance.

LM80

LM80 testing is on going. Please contact your Bridgelux sales representative for more information.

Precautions

CAUTION: CHEMICAL EXPOSURE HAZARD

Exposure to some chemicals commonly used in luminaire manufacturing and assembly can cause damage to the LED array. Please consult Bridgelux Application Note AN31 for additional information.

CAUTION: RISK OF BURN

Do not touch the Vero LED array during operation. Allow the array to cool for a sufficient period of time before handling. The Vero LED array may reach elevated temperatures such that could burn skin when touched.

CAUTION

CONTACT WITH LIGHT EMITTING SURFACE (LES)

Avoid any contact with the LES. Do not touch the LES of the LED array or apply stress to the LES (yellow phosphor resin area). Contact may cause damage to the LED array.

Optics and reflectors must not be mounted in contact with the LES (yellow phosphor resin area). Optical devices may be mounted on the top surface of the plastic housing of the Vero SE LED array. Use the mechanical features of the LED array housing, edges and/or mounting holes to locate and secure optical devices as needed.

Disclaimers

MINOR PRODUCT CHANGE POLICY

The rigorous qualification testing on products offered by Bridgelux provides performance assurance. Slight cosmetic changes that do not affect form, fit, or function may occur as Bridgelux continues product optimization.

STANDARD TEST CONDITIONS

Unless otherwise stated, array testing is performed at the nominal drive current.

About Bridgelux: We Build Light That Transforms

At Bridgelux, we help companies, industries and people experience the power and possibility of light. Since 2002, we've designed LED solutions that are high performing, energy efficient, cost effective and easy to integrate. Our focus is on light's impact on human behavior, delivering products that create better environments, experiences and returns—both experiential and financial. And our patented technology drives new platforms for commercial and industrial luminaires.

For more information about the company, please visit

bridgelux.com

twitter.com/Bridgelux

facebook.com/Bridgelux

linkedin.com/company/Bridgelux-inc-_2

WeChat ID: BridgeluxInChina



101 Portola Avenue

Livermore, CA 94551

Tel (925) 583-8400

Fax (925) 583-8401

www.bridgelux.com

© 2016 Bridgelux, Inc. All rights reserved 2016. Product specifications are subject to change without notice. Bridgelux, the Bridgelux stylized logo design and Vero are registered trademarks, and Décor Series is a trademark of Bridgelux, Inc. All other trademarks are the property of their respective owners.

Bridgelux Décor Series on Vero SE Product Data Sheet DS124 Rev. A (10/2016)