



Aluminum electrolytic capacitors

Axial-lead and soldering star capacitors

Series/Type: B41689, B41789

Date: November 2012

Applications

- Automotive electronics

Features

- Very high ripple current capability
- Long useful life, 2000 h at up to 150 °C
- Low ESR also at 63 V DC
- High vibration stability
- Shelf life up to 15 years at storage temperatures up to 40 °C.
To ensure solderability, the capacitors should be built into the application within one year of delivery. After a total of two years' storage, the operating voltage must be applied for one hour to ensure the specified leakage current.
- RoHS-compatible

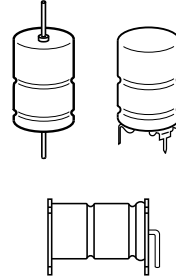

Construction

- Charge/discharge-proof, polar
- Aluminum case with insulating sleeve
- Negative pole connected to case

Terminals

- Axial leads, welded to ensure perfect electrical contact
- Soldering star for upright mounting on PCB available
- Alternative axial-lead design with double-sided plates for horizontal mounting available upon request

Taping and packing

- Axial-lead capacitors will be delivered in pallet package
Capacitors with $d \times l \leq 16 \times 30$ mm are also available taped on reel
- Soldering star capacitors are packed in cardboard

Specifications and characteristics in brief

Rated voltage V_R	25 ... 63 V DC				
Surge voltage V_S	1.15 · V_R for ≤ 40 V DC 1.10 · V_R for 63 V DC				
Rated capacitance C_R	270 ... 4500 μF				
Capacitance tolerance	–10/+30% \triangleq Q				
Leakage current I_{leak} (5 min, 20 °C)	$I_{\text{leak}} \leq 0.006 \mu\text{A} \cdot \left(\frac{C_R}{\mu\text{F}} \cdot \frac{V_R}{V} \right) + 4 \mu\text{A}$				
Self-inductance ESL ¹⁾	Diameter d (mm)	16	18	20/21	
	Terminals	Length l (mm)	Approx. ESL (nH)		
	axial	25	26	30	–
		29	–	–	38
		30	29	34	–
		35	31	–	–
		39	33	38	45
		49	–	–	50
	soldering star	25	7	8	–
		30	8	10	–
		35	9	–	–
39		9	11	13	
49		–	–	14	
Useful life ²⁾ 150 °C; V_R ; 0.5 · $I_{AC,R}$ 125 °C; V_R ; $I_{AC,R}$ 125 °C; V_R ; $I_{AC,max}$ 40 °C; V_R ; 2.1 · $I_{AC,R}$	> 2000 h	Requirements:			
	> 10000 h	$\Delta C/C$	$\leq \pm 30\%$ of initial value		
	> 4000 h	ESR	≤ 3 times initial specified limit ³⁾		
	> 500000 h	I_{leak}	\leq initial specified limit		
Voltage endurance test 125 °C; V_R	4000 h	Post test requirements:			
		$\Delta C/C$	$\leq \pm 10\%$ of initial value		
		ESR	$\leq 1.3\%$ initial specified limit ³⁾		
		I_{leak}	\leq initial specified limit		
Vibration resistance test	To IEC 60068-2-6, test Fc: Frequency range 10 Hz ... 2 kHz, displacement amplitude max. 1.5 mm, acceleration max. 20 g, duration 3 × 2 h. Capacitor mounted by its wire leads at a distance of (6 ± 1) mm from the case and additionally clamped by the case.				
IEC climatic category	To IEC 60068-1: 55/125/56 (–55 °C/+125 °C/56 days damp heat test)				
Detail specification	Similar to CECC 30301-802				
Sectional specification	IEC 60384-4				

1) If optimum circuit design is used, the values are lower by 30%.

2) Refer to chapter "General technical information, 5 Useful life" on how to interpret useful life.

3) ESR_{max} at 100 Hz, 20 °C



B41689, B41789

Very high ripple current – up to 150 °C

B41689, Axial-lead capacitors

Dimensional drawing

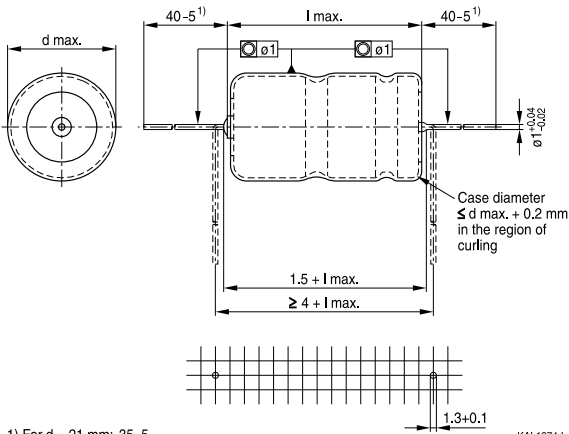

Dimensions, weights and packing units

$d \times l$ mm	$d_{max} \times l_{max}$ mm	Approx. weight g	Packing units (pcs.)	
			Pallet	Reel
16 × 25	16.5 × 25.5	7.4	180	250
16 × 30	16.5 × 30.5	8.9	180	250
16 × 35	16.5 × 35.5	10.4	180	—
16 × 39	16.5 × 40	11.7	180	—
18 × 25	18.5 × 25.5	9.3	160	—
18 × 30	18.5 × 30.5	11.1	160	—
18 × 39	18.5 × 40	14.7	160	—
20 × 29	20.5 × 29.5	13.5	140	—
21 × 39	21.5 × 40	20.0	140	—
21 × 49	21.5 × 50	25.0	110	—

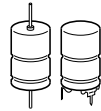

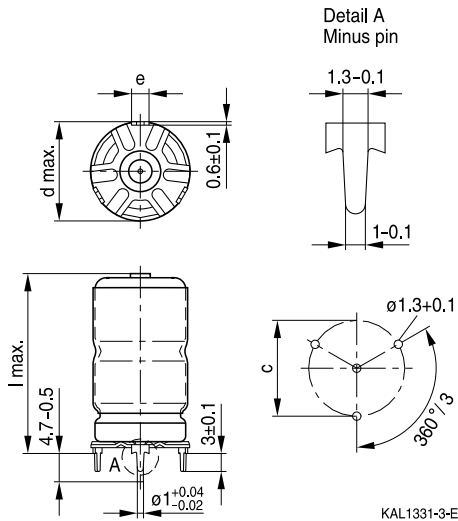
B41789, Soldering star capacitors
Dimensional drawings

 Mounting holes $d = 16 \text{ mm} \dots 21 \text{ mm}$

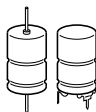
Dimensions, weights and packing units

$d \times l$ mm	$d_{\text{max}} \times l_{\text{max}}$ mm	$c \pm 0.1$ mm	$e \pm 0.1$ mm	Approx. weight g	Packing units pcs.
16 × 25	17.5 × 27	16.5	3.0	7.9	300
16 × 30	17.5 × 32	16.5	3.0	9.4	300
16 × 35	17.5 × 37	16.5	3.0	10.9	200
16 × 39	17.5 × 41.5	16.5	3.0	12.2	200
18 × 25	19.5 × 27	18.5	3.0	9.9	300
18 × 30	19.5 × 32	18.5	3.0	11.8	300
18 × 39	19.5 × 41.5	18.5	3.0	15.4	200
21 × 39	22.5 × 41.5	21.5	3.5	21.0	324
21 × 49	22.5 × 51.5	21.5	3.5	26.0	264

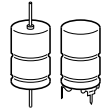
B41689, B41789
Very high ripple current – up to 150 °C
Overview of available types

V_R (V DC)	25	40	63
	Case dimensions $d \times l$ (mm)		
C_R (μF)			
270			16 × 25
330			16 × 30
390			18 × 25
470			16 × 35
560		16 × 25	18 × 30
590			16 × 39
600			20 × 29
680		18 × 25	
720		16 × 30	
820		16 × 35	18 × 39
900		18 × 30	
1000	16 × 25	16 × 39	21 × 39
1200	18 × 25	20 × 29	
1300	16 × 30		21 × 49
1400		18 × 39	
1500	16 × 35		
1700	18 × 30		
1800	16 × 39		
1900	20 × 29		
2000		21 × 39	
2200	18 × 39		
2700		21 × 49	
3300	21 × 39		
4500	21 × 49		

Case dimensions and ordering codes

V_R	C_R	Case dimensions $d \times l$ mm	Ordering code Axial pallet	Ordering code Axial reel	Ordering code Soldering star
25	1000	16 × 25	B41689A5108Q001	B41689A5108Q003	B41789A5108Q001
	1000 ▽	16 × 25	B41689K5108Q001	B41689K5108Q003	B41789K5108Q001
	1200	18 × 25	B41689A5128Q001		B41789A5128Q001
	1200 ▽	18 × 25	B41689K5128Q001		B41789K5128Q001
	1300	16 × 30	B41689A5138Q001	B41689A5138Q003	B41789A5138Q001
	1300 ▽	16 × 30	B41689K5138Q001	B41689K5138Q003	B41789K5138Q001
	1500	16 × 35	B41689A5158Q001		B41789A5158Q001
	1500 ▽	16 × 35	B41689K5158Q001		B41789K5158Q001
	1700	18 × 30	B41689A5178Q001		B41789A5178Q001
	1700 ▽	18 × 30	B41689K5178Q001		B41789K5178Q001
	1800	16 × 39	B41689A5188Q001		B41789A5188Q001
	1800 ▽	16 × 39	B41689K5188Q001		B41789K5188Q001
	1900	20 × 29	B41689A5198Q001		
	1900 ▽	20 × 29	B41689K5198Q001		
	2200	18 × 39	B41689A5228Q001		B41789A5228Q001
	2200 ▽	18 × 39	B41789K5228Q001		B41789K5228Q001
	3300	21 × 39	B41689A5338Q001		B41789A5338Q001
	3300 ▽	21 × 39	B41689K5338Q001		B41789K5338Q001
	4500	21 × 49	B41689A5458Q001		B41789A5458Q001
	4500 ▽	21 × 49	B41689K5458Q001		B41789K5458Q001
40	560	16 × 25	B41689A7567Q001	B41689A7567Q003	B41789A7567Q001
	560 ▽	16 × 25	B41689K7567Q001	B41689K7567Q003	B41789K7567Q001
	680	18 × 25	B41689A7687Q001		B41789A7687Q001
	680 ▽	18 × 25	B41689K7687Q001		B41789K7687Q001
	720	16 × 30	B41689A7727Q001	B41689A7727Q003	B41789A7727Q001
	720 ▽	16 × 30	B41689K7727Q001	B41689K7727Q003	B41789K7727Q001
	820	16 × 35	B41689A7827Q001		B41789A7827Q001
	820 ▽	16 × 35	B41689K7827Q001		B41789K7827Q001
	900	18 × 30	B41689A7907Q001		B41789A7907Q001
	900 ▽	18 × 30	B41689K7907Q001		B41789K7907Q001

▽ Increased ripple current due to optimized thermal design

B41689, B41789
Very high ripple current – up to 150 °C

V_R	C_R 120 Hz 20 °C V DC μF	Case dimensions d × l mm	Ordering code Axial pallet	Ordering code Axial reel	Ordering code Soldering star
40	1000	16 × 39	B41689A7108Q001		B41789A7108Q001
	1000 ▽	16 × 39	B41689K7108Q001		B41789K7108Q001
	1200	20 × 29	B41689A7128Q001		
	1200 ▽	20 × 29	B41689K7128Q001		
	1400	18 × 39	B41689A7148Q001		B41789A7148Q001
	1400 ▽	18 × 39	B41689K7148Q001		B41789K7148Q001
	2000	21 × 39	B41689A7208Q001		B41789A7208Q001
	2000 ▽	21 × 39	B41689K7208Q001		B41789K7208Q001
	2700	21 × 49	B41689A7278Q001		B41789A7278Q001
	2700 ▽	21 × 49	B41689K7278Q001		B41789K7278Q001
63	270	16 × 25	B41689A8277Q001	B41689A8277Q003	B41789A8277Q001
	270 ▽	16 × 25	B41689K8277Q001	B41689K8277Q003	B41789K8277Q001
	330	16 × 30	B41689A8337Q001	B41689A8337Q003	B41789A8337Q001
	330 ▽	16 × 30	B41689K8337Q001	B41689K8337Q003	B41789K8337Q001
	390	18 × 25	B41689A8397Q001		B41789A8397Q001
	390 ▽	18 × 25	B41689K8397Q001		B41789K8397Q001
	470	16 × 35	B41689A8477Q001		B41789A8477Q001
	470 ▽	16 × 35	B41689K8477Q001		B41789K8477Q001
	560	18 × 30	B41689A8567Q001		B41789A8567Q001
	560 ▽	18 × 30	B41689K8567Q001		B41789K8567Q001
	590	16 × 39	B41689A8597Q001		B41789A8597Q001
	590 ▽	16 × 39	B41689K8597Q001		B41789K8597Q001
	600	20 × 29	B41689A8607Q001		
	600 ▽	20 × 29	B41689K8607Q001		
	820	18 × 39	B41689A8827Q001		B41789A8827Q001
	820 ▽	18 × 39	B41689K8827Q001		B41789K8827Q001
	1000	21 × 39	B41689A8108Q001		B41789A8108Q001
	1000 ▽	21 × 39	B41689K8108Q001		B41789K8108Q001
	1300	21 × 49	B41689A8138Q001		B41789A8138Q001
		1300 ▽	21 × 49	B41689K8138Q001	

▽ Increased ripple current due to optimized thermal design

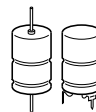
Technical data

C_R	Case dimensions	ESR_{max} 100 Hz 20 °C	ESR_{max} 100 Hz -40 °C	ESR_{max} 10 kHz 20 °C	Z_{max} 100 kHz 20 °C	$I_{AC,max}^{1)}$ 10 kHz T_C 125 °C	$I_{AC,max}$ 10 kHz 125 °C	$I_{AC,R}$ 10 kHz 125 °C	$I_{AC,max}$ 10 kHz 150 °C
μF	mm	m Ω	m Ω	m Ω	m Ω	A	A	A	A
$V_R = 25$ V DC									
1000	16 × 25	98	565	53	50	9.2	5.7	3.5	1.7
1000 ▽	16 × 25	98	565	53	50	10.1	6.0	3.6	1.8
1200	18 × 25	80	470	43	41	11.1	6.9	4.2	2.1
1200 ▽	18 × 25	80	470	43	41	12.2	7.2	4.4	2.2
1300	16 × 30	75	435	41	39	11.4	7.1	4.3	2.2
1300 ▽	16 × 30	75	435	41	39	12.5	7.4	4.5	2.2
1500	16 × 35	65	377	35	34	13.3	8.3	5.0	2.5
1500 ▽	16 × 35	65	377	35	34	14.6	8.6	5.2	2.6
1700	18 × 30	57	332	31	29	14.1	8.8	5.3	2.7
1700 ▽	18 × 30	57	332	31	29	15.5	9.1	5.5	2.8
1800	16 × 39	55	314	30	28	15.1	9.4	5.7	2.9
1800 ▽	16 × 39	55	314	30	28	16.6	9.8	5.9	3.0
1900	20 × 29	52	297	28	27	14.5	9.1	5.5	2.7
1900 ▽	20 × 29	52	297	28	27	16.0	9.5	5.7	2.9
2200	18 × 39	44	257	24	23	18.3	11.4	6.9	3.4
2200 ▽	18 × 39	44	257	24	23	20.1	11.8	7.2	3.6
3300	21 × 39	31	172	17	16	21.0	13.1	7.9	4.0
3300 ▽	21 × 39	31	172	17	16	23.2	13.6	8.3	4.1
4500	21 × 49	23	126	13	12	26.5	16.5	10.0	5.0
4500 ▽	21 × 49	23	126	13	12	29.2	17.2	10.4	5.2
$V_R = 40$ V DC									
560	16 × 25	129	587	53	50	9.2	5.7	3.5	1.7
560 ▽	16 × 25	129	587	53	50	10.1	6.0	3.6	1.8
680	18 × 25	105	483	43	41	11.1	6.9	4.2	2.1
680 ▽	18 × 25	105	483	43	41	12.3	7.2	4.4	2.2
720	16 × 30	100	457	42	39	11.4	7.1	4.3	2.1
720 ▽	16 × 30	100	457	42	39	12.5	7.4	4.5	2.2
820	16 × 35	88	401	36	34	13.2	8.2	5.0	2.5
820 ▽	16 × 35	88	401	36	34	14.5	8.6	5.2	2.6
900	18 × 30	80	365	33	31	13.9	8.6	5.2	2.6
900 ▽	18 × 30	80	365	33	31	15.2	9.0	5.4	2.7

▽ Increased ripple current due to optimized thermal design

1) Maximum ripple current at 125 °C capacitor case temperature T_C (measured at aluminum case surface), when mounted to a heat sink. Further details available upon request.

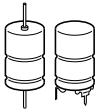
B41689, B41789
Very high ripple current – up to 150 °C

C_R	Case dimensions	ESR_{max} 100 Hz 20 °C mΩ	ESR_{max} 100 Hz -40 °C mΩ	ESR_{max} 10 kHz 20 °C mΩ	Z_{max} 100 kHz 20 °C mΩ	$I_{AC,max}^{(2)}$ 10 kHz T_C 125 °C A	$I_{AC,max}$ 10 kHz 125 °C A	$I_{AC,R}$ 10 kHz 125 °C A	$I_{AC,max}$ 10 kHz 150 °C A
120 Hz 20 °C μF	d × l mm								
$V_R = 40$ V DC									
1000	16 × 39	73	329	30	29	15.1	9.4	5.7	2.8
1000 ▽	16 × 39	73	329	30	29	16.6	9.8	5.9	3.0
1200	20 × 29	61	274	26	24	14.9	9.3	5.6	2.8
1200 ▽	20 × 29	61	274	26	24	16.5	9.7	5.9	2.9
1400	18 × 39	52	235	22	20	18.9	11.8	7.1	3.6
1400 ▽	18 × 39	52	235	22	20	20.8	12.2	7.4	3.7
2000	21 × 39	38	165	16	16	21.3	13.2	8.0	4.0
2000 ▽	21 × 39	38	165	16	16	23.4	13.8	8.4	4.2
2700	21 × 49	28	123	12	12	26.8	16.7	10.1	5.0
2700 ▽	21 × 49	28	123	12	12	29.5	17.4	10.5	5.3
$V_R = 63$ V DC									
270	16 × 25	218	777	66	63	8.4	5.2	3.2	1.6
270 ▽	16 × 25	218	777	66	63	9.2	5.4	3.3	1.6
330	16 × 30	178	636	54	51	10.3	6.4	3.9	1.9
330 ▽	16 × 30	178	636	54	51	11.2	6.6	4.0	2.0
390	18 × 25	160	602	54	51	9.5	5.9	3.6	1.8
390 ▽	18 × 25	160	602	54	51	10.4	6.1	3.7	1.9
470	16 × 35	131	498	43	41	12.3	7.7	4.6	2.3
470 ▽	16 × 35	131	498	43	41	13.4	7.9	4.8	2.4
560	18 × 30	113	420	39	37	12.0	7.5	4.5	2.3
560 ▽	18 × 30	113	420	39	37	13.1	7.7	4.7	2.3
590	16 × 39	105	397	35	33	14.2	8.8	5.3	2.7
590 ▽	16 × 39	105	397	35	33	15.5	9.1	5.5	2.8
600	20 × 29	99	350	31	29	13.9	8.7	5.3	2.6
600 ▽	20 × 29	99	350	31	29	15.2	9.0	5.4	2.7
820	18 × 39	78	287	27	26	16.1	10.0	6.1	3.0
820 ▽	18 × 39	78	287	27	26	17.6	10.4	6.3	3.1
1000	21 × 39	61	211	19	18	20.0	12.4	7.5	3.8
1000 ▽	21 × 39	61	211	19	18	21.8	12.9	7.8	3.9
1300	21 × 49	47	162	15	14	25.1	15.6	9.5	4.7
1300 ▽	21 × 49	47	162	15	14	27.4	16.2	9.8	4.9

▽ Increased ripple current due to optimized thermal design

2) Maximum ripple current at 125 °C capacitor case temperature T_C (measured at aluminum case surface), when mounted to a heat sink. Further details available upon request.

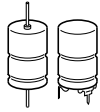

Useful life¹⁾

depending on ambient temperature T_A under ripple current operating conditions at V_R

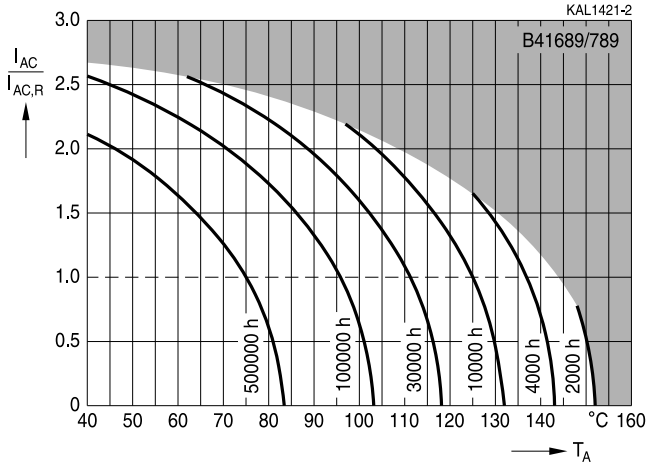

1) Refer to chapter "General technical information, 5 Useful life" on how to interpret useful life.



B41689, B41789

Very high ripple current – up to 150 °C

Frequency factor of permissible ripple current I_{AC} versus frequency f

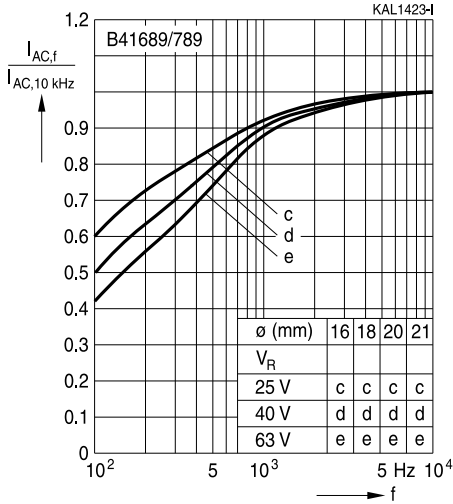

**Frequency characteristics of ESR
Typical behavior**

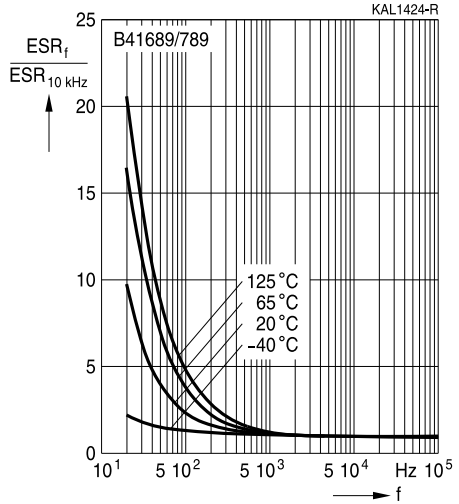

**Equivalent series resistance ESR
versus frequency f**

Typical behavior for 470 μ F/63 V

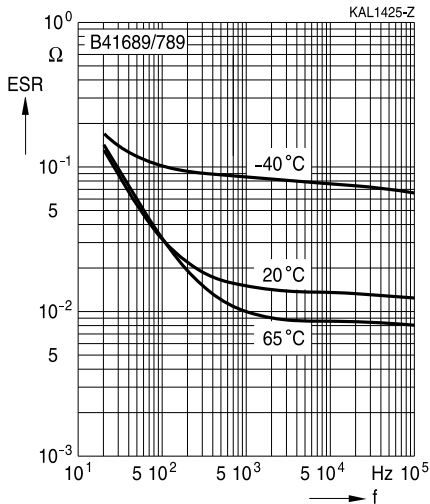

**Impedance Z
versus frequency f**

Typical behavior for 470 μ F/63 V

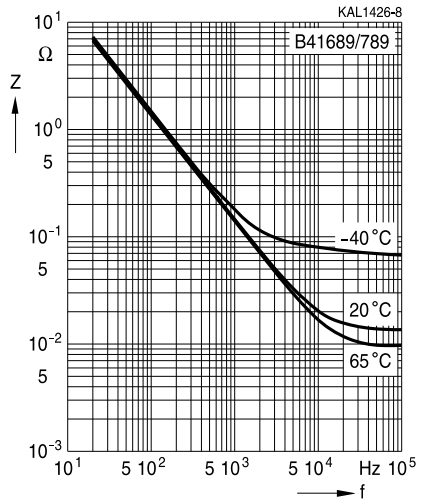

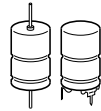

Cautions and warnings

Personal safety

The electrolytes used by EPCOS have been optimized both with a view to the intended application and with regard to health and environmental compatibility. They do not contain any solvents that are detrimental to health, e.g. dimethyl formamide (DMF) or dimethyl acetamide (DMAC).

Furthermore, some of the high-voltage electrolytes used by EPCOS are self-extinguishing.

As far as possible, EPCOS does not use any dangerous chemicals or compounds to produce operating electrolytes. However, in exceptional cases, such materials must be used in order to achieve specific physical and electrical properties because no alternative materials are currently known. However, the amount of dangerous materials used in our products is limited to an absolute minimum.

Materials and chemicals used in EPCOS aluminum electrolytic capacitors are continuously adapted in compliance with the EPCOS Corporate Environmental Policy and the latest EU regulations and guidelines such as RoHS, REACH/SVHC, GADSL, and ELV.

MDS (Material Data Sheets) are available on the EPCOS website for all types listed in the data book. MDS for customer specific capacitors are available upon request.

MSDS (Material Safety Data Sheets) are available for all of our electrolytes upon request.

Nevertheless, the following rules should be observed when handling aluminum electrolytic capacitors: No electrolyte should come into contact with eyes or skin. If electrolyte does come into contact with the skin, wash the affected areas immediately with running water. If the eyes are affected, rinse them for 10 minutes with plenty of water. If symptoms persist, seek medical treatment. Avoid inhaling electrolyte vapor or mists. Workplaces and other affected areas should be well ventilated. Clothing that has been contaminated by electrolyte must be changed and rinsed in water.



Product safety

The table below summarizes the safety instructions that must be observed without fail. A detailed description can be found in the relevant sections of chapter "General technical information".

Topic	Safety information	Reference chapter "General technical information"
Polarity	Make sure that polar capacitors are connected with the right polarity.	1 "Basic construction of aluminum electrolytic capacitors"
Reverse voltage	Voltages polarity classes should be prevented by connecting a diode.	3.1.6 "Reverse voltage"
Mounting position of screw-terminal capacitors	Do not mount the capacitor with the terminals (safety vent) upside down.	11.1. "Mounting positions of capacitors with screw terminals"
Robustness of terminals	The following maximum tightening torques must not be exceeded when connecting screw terminals: M5: 2.5 Nm M6: 4.0 Nm	11.3 "Mounting torques"
Mounting of single-ended capacitors	The internal structure of single-ended capacitors might be damaged if excessive force is applied to the lead wires. Avoid any compressive, tensile or flexural stress. Do not move the capacitor after soldering to PC board. Do not pick up the PC board by the soldered capacitor. Do not insert the capacitor on the PC board with a hole space different to the lead space specified.	11.4 "Mounting considerations for single-ended capacitors"
Soldering	Do not exceed the specified time or temperature limits during soldering.	11.5 "Soldering"
Soldering, cleaning agents	Do not allow halogenated hydrocarbons to come into contact with aluminum electrolytic capacitors.	11.6 "Cleaning agents"
Upper category temperature	Do not exceed the upper category temperature.	7.2 "Maximum permissible operating temperature"
Passive flammability	Avoid external energy, such as fire or electricity.	8.1 "Passive flammability"



Topic	Safety information	Reference chapter "General technical information"
Active flammability	Avoid overload of the capacitors.	8.2 "Active flammability"
Maintenance	Make periodic inspections of the capacitors. Before the inspection, make sure that the power supply is turned off and carefully discharge the electricity of the capacitors. Do not apply any mechanical stress to the capacitor terminals.	10 "Maintenance"
Storage	Do not store capacitors at high temperatures or high humidity. Capacitors should be stored at +5 to +35 °C and a relative humidity of $\leq 75\%$.	7.3 Storage conditions
		Reference chapter "Capacitors with screw terminals"
Breakdown strength of insulating sleeves	Do not damage the insulating sleeve, especially when ring clips are used for mounting.	"Screw terminals – accessories"

B41689, B41789
Very high ripple current – up to 150 °C
Symbols and terms

Symbol	English	German
C	Capacitance	Kapazität
C_R	Rated capacitance	Nennkapazität
C_S	Series capacitance	Serienkapazität
$C_{S,T}$	Series capacitance at temperature T	Serienkapazität bei Temperatur T
C_f	Capacitance at frequency f	Kapazität bei Frequenz f
d	Case diameter, nominal dimension	Gehäusedurchmesser, Nennmaß
d_{max}	Maximum case diameter	Maximaler Gehäusedurchmesser
ESL	Self-inductance	Eigeninduktivität
ESR	Equivalent series resistance	Ersatzserienwiderstand
ESR_f	Equivalent series resistance at frequency f	Ersatzserienwiderstand bei Frequenz f
ESR_T	Equivalent series resistance at temperature T	Ersatzserienwiderstand bei Temperatur T
f	Frequency	Frequenz
I	Current	Strom
I_{AC}	Alternating current (ripple current)	Wechselstrom
$I_{AC,rms}$	Root-mean-square value of alternating current	Wechselstrom, Effektivwert
$I_{AC,f}$	Ripple current at frequency f	Wechselstrom bei Frequenz f
$I_{AC,max}$	Maximum permissible ripple current	Maximal zulässiger Wechselstrom
$I_{AC,R}$	Rated ripple current	Nennwechselstrom
$I_{AC,R} (B)$	Rated ripple current for base cooling	Nennwechselstromstrom für Bodenkühlung
I_{leak}	Leakage current	Reststrom
$I_{leak,op}$	Operating leakage current	Betriebsreststrom
l	Case length, nominal dimension	Gehäuselänge, Nennmaß
l_{max}	Maximum case length (without terminals and mounting stud)	Maximale Gehäuselänge (ohne Anschlüsse und Gewindebolzen)
R	Resistance	Widerstand
R_{ins}	Insulation resistance	Isolationswiderstand
R_{symm}	Balancing resistance	Symmetrierwiderstand
T	Temperature	Temperatur
ΔT	Temperature difference	Temperaturdifferenz
T_A	Ambient temperature	Umgebungstemperatur
T_C	Case temperature	Gehäusetemperatur
T_B	Capacitor base temperature	Temperatur des Becherbodens
t	Time	Zeit
Δt	Period	Zeitraum
t_b	Service life (operating hours)	Brauchbarkeitsdauer (Betriebszeit)

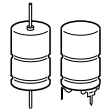

Symbol	English	German
V	Voltage	Spannung
V _F	Forming voltage	Formierspannung
V _{op}	Operating voltage	Betriebsspannung
V _R	Rated voltage, DC voltage	Nennspannung, Gleichspannung
V _S	Surge voltage	Spitzenspannung
X _C	Capacitive reactance	Kapazitiver Blindwiderstand
X _L	Inductive reactance	Induktiver Blindwiderstand
Z	Impedance	Scheinwiderstand
Z _T	Impedance at temperature T	Scheinwiderstand bei Temperatur T
tan δ	Dissipation factor	Verlustfaktor
λ	Failure rate	Ausfallrate
ε ₀	Absolute permittivity	Elektrische Feldkonstante
ε _r	Relative permittivity	Dielektrizitätszahl
ω	Angular velocity; 2 · π · f	Kreisfrequenz; 2 · π · f

Note

All dimensions are given in mm.

Important notes

The following applies to all products named in this publication:

1. Some parts of this publication contain **statements about the suitability of our products for certain areas of application**. These statements are based on our knowledge of typical requirements that are often placed on our products in the areas of application concerned. We nevertheless expressly point out **that such statements cannot be regarded as binding statements about the suitability of our products for a particular customer application**. As a rule, EPCOS is either unfamiliar with individual customer applications or less familiar with them than the customers themselves. For these reasons, it is always ultimately incumbent on the customer to check and decide whether an EPCOS product with the properties described in the product specification is suitable for use in a particular customer application.
2. We also point out that **in individual cases, a malfunction of electronic components or failure before the end of their usual service life cannot be completely ruled out in the current state of the art, even if they are operated as specified**. In customer applications requiring a very high level of operational safety and especially in customer applications in which the malfunction or failure of an electronic component could endanger human life or health (e.g. in accident prevention or lifesaving systems), it must therefore be ensured by means of suitable design of the customer application or other action taken by the customer (e.g. installation of protective circuitry or redundancy) that no injury or damage is sustained by third parties in the event of malfunction or failure of an electronic component.
3. **The warnings, cautions and product-specific notes must be observed.**
4. In order to satisfy certain technical requirements, **some of the products described in this publication may contain substances subject to restrictions in certain jurisdictions (e.g. because they are classed as hazardous)**. Useful information on this will be found in our Material Data Sheets on the Internet (www.epcos.com/material). Should you have any more detailed questions, please contact our sales offices.
5. We constantly strive to improve our products. Consequently, **the products described in this publication may change from time to time**. The same is true of the corresponding product specifications. Please check therefore to what extent product descriptions and specifications contained in this publication are still applicable before or when you place an order. We also **reserve the right to discontinue production and delivery of products**. Consequently, we cannot guarantee that all products named in this publication will always be available. The aforementioned does not apply in the case of individual agreements deviating from the foregoing for customer-specific products.
6. Unless otherwise agreed in individual contracts, **all orders are subject to the current version of the "General Terms of Delivery for Products and Services in the Electrical Industry" published by the German Electrical and Electronics Industry Association (ZVEI)**.
7. The trade names EPCOS, BAOKE, Alu-X, CeraDiode, CeraLink, CSMP, CSSP, CTVS, DeltaCap, DigiSiMic, DSSP, FilterCap, FormFit, MiniBlue, MiniCell, MKD, MKK, MLSC, MotorCap, PCC, PhaseCap, PhaseCube, PhaseMod, PhiCap, SIFERRIT, SIFI, SIKOREL, SilverCap, SIMDAD, SiMic, SIMID, SineFormer, SIOV, SIP5D, SIP5K, ThermoFuse, WindCap are **trademarks registered or pending** in Europe and in other countries. Further information will be found on the Internet at www.epcos.com/trademarks.

Mouser Electronics

Authorized Distributor

Click to View Pricing, Inventory, Delivery & Lifecycle Information:

EPCOS:

<u>B41789K5338Q001</u>	<u>B41789A8567Q001</u>	<u>B41689K5178Q001</u>	<u>B41689K7687Q001</u>	<u>B41789K5138Q001</u>
<u>B41789A8108Q001</u>	<u>B41689K8477Q001</u>	<u>B41789A7567Q001</u>	<u>B41789A5188Q001</u>	<u>B41789K5228Q001</u>
<u>B41689A5228Q001</u>	<u>B41689A7148Q001</u>	<u>B41789A7108Q001</u>	<u>B41789K5128Q001</u>	<u>B41689K8108Q001</u>
<u>B41789A7278Q001</u>	<u>B41689A5128Q001</u>	<u>B41689K7108Q001</u>	<u>B41789K7148Q001</u>	<u>B41789A5458Q001</u>
<u>B41789A7687Q001</u>	<u>B41689K5188Q001</u>	<u>B41689K7827Q001</u>	<u>B41789A5158Q001</u>	<u>B41689A8138Q001</u>
<u>B41789K8138Q001</u>	<u>B41689A7727Q001</u>	<u>B41789A7208Q001</u>	<u>B41689K5158Q001</u>	<u>B41689A8827Q001</u>
<u>B41689K7567Q001</u>	<u>B41789A7907Q001</u>	<u>B41689A5108Q001</u>	<u>B41789K7727Q001</u>	<u>B41789K8827Q001</u>
<u>B41689A8397Q001</u>	<u>B41689A5178Q001</u>	<u>B41789A5138Q001</u>	<u>B41689A5188Q001</u>	<u>B41689A7128Q001</u>
<u>B41689A7827Q001</u>	<u>B41789A5338Q001</u>	<u>B41689A8597Q001</u>	<u>B41689A8277Q001</u>	<u>B41689K8277Q001</u>
<u>B41689A8477Q001</u>	<u>B41689A7278Q001</u>	<u>B41789K8108Q001</u>	<u>B41689K7907Q001</u>	<u>B41689K8567Q001</u>
<u>B41689K5338Q001</u>	<u>B41689K5138Q001</u>	<u>B41789K5178Q001</u>	<u>B41789K8567Q001</u>	<u>B41789A5228Q001</u>
<u>B41789A5128Q001</u>	<u>B41689K8138Q001</u>	<u>B41789K8337Q001</u>	<u>B41789A8337Q001</u>	<u>B41789K5108Q001</u>
<u>B41689A7208Q001</u>	<u>B41689A7907Q001</u>	<u>B41789K8397Q001</u>	<u>B41689A7108Q001</u>	<u>B41789A7148Q001</u>
<u>B41689K8337Q001</u>	<u>B41789K8277Q001</u>	<u>B41789K8477Q001</u>	<u>B41689A7687Q001</u>	<u>B41689A8567Q001</u>
<u>B41789K8597Q001</u>	<u>B41789A8138Q001</u>	<u>B41789K5188Q001</u>	<u>B41789K7827Q001</u>	<u>B41689K5228Q001</u>
<u>B41689K5128Q001</u>	<u>B41689K7278Q001</u>	<u>B41689A5138Q001</u>	<u>B41689K8597Q001</u>	<u>B41789A5178Q001</u>
<u>B41689K7208Q001</u>	<u>B41689K8607Q001</u>	<u>B41789A7727Q001</u>	<u>B41789A8827Q001</u>	<u>B41789A5108Q001</u>
<u>B41789K5458Q001</u>	<u>B41689K8397Q001</u>	<u>B41689A5338Q001</u>	<u>B41689K5458Q001</u>	<u>B41689A8607Q001</u>
<u>B41789A7827Q001</u>	<u>B41689A5458Q001</u>	<u>B41689A8108Q001</u>	<u>B41689A5198Q001</u>	<u>B41789A8597Q001</u>
<u>B41789A8477Q001</u>	<u>B41689K7148Q001</u>	<u>B41789A8277Q001</u>	<u>B41789K7108Q001</u>	<u>B41789A8397Q001</u>