



Ty-Rap®

Premium cable ties with steel locking barb Characteristics

Special features of the Ty-Rap® programme

The single most distinguishing feature of the Ty-Rap® cable ties from Thomas & Betts is the stainless steel locking barb, firmly anchored inside the tie head (Fig. 1).

It is made from corrosion-proof, antimagnetic steel (Marine Grade Type 316).

This guarantees a strong and durable locking of the tie even under the most adverse conditions - humidity, heat, cold, etc. and is also proof against vibration and external shock.

When applying ties with Thomas & Betts tooling, the excess end of the tie is automatically cut off and the slight over cut retracts into the tie, so that there is no risk of injury from protruding sharp edges. (Fig. 3)

The low-profile design of the head allows secure tying in tight spaces.

The edges of the head are also rounded off to offer maximum protection from injury.

The transition from the strap to the head is gradual. This protects the material against breaking at this most critical point.

The rounded edges of the head and strap ensure the comfortable handling of the ties. Once the tie is installed, the rounded edges protect the cable from damage.

The steel locking barb ensures a strong, reliable and long lasting fastening.

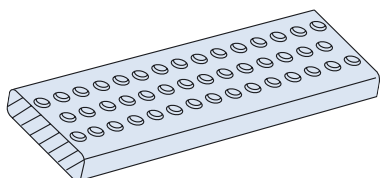

The ribbed and stippled surface prevents the tie from slipping on the bundle under vibration conditions.

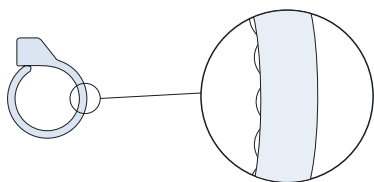

Angled tail for fast and easy insertion into the locking head. The angle and the surface of the tail are ideally suited for gripping and inserting.

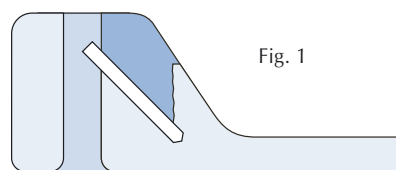
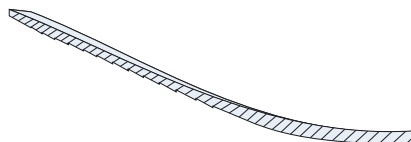

Steel locking barb anchored in tie head

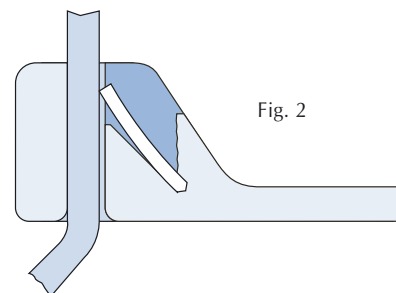

Secure lock in any position

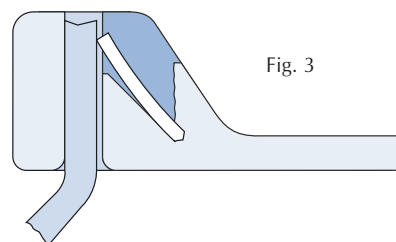

Retracted strap end after application

Ty-Rap®

Premium cable ties with steel locking barb Characteristics

Other advantages of the Ty-Rap® cable ties

- MIL-specified tie and application tools
- VG-approved types
- UL-approved (UL File No. E 49405)
- Approved by Germanischer Lloyd and Lloyd's Register of Shipping
- 6 different materials (for a total of 9 different grades) and 3 different flammability ratings: UL 94 V-2 / UL 94 V-0 / UL 94 HB
- Wide choice of colours
- Different tool systems to suit all production volumes
- 4 different packaging sizes to optimally suit your production requirements
- Recyclable packaging for a better contribution to the environment

Packaging sizes

Standard packaging

1000 pieces in recyclable polythene bags (for cable ties with sizes from 2.4 mm to 4.8 mm wide)

500 pieces in recyclable polythene bags (for cable ties with sizes of 7.0 mm and 7.6 mm wide)

Product Ref. information

No addition to the Product Ref. for standard packaging

Workbench boxes

An attractive packaging option for high volume manual assembly: 1000 pieces in a workbench box - easy to reach, hence timesaving. This user-friendly packaging allows fast working without problems or losses.

The following tie types are available:

TYB23M / TYB2315M / TYB24M /
TYB25M / TYB23MX / TYB2315MX/
TYB24MX / TYB25MX + colours.

Product Ref. information

Add "B" to the Product Ref.

Example: TYB23M

= 1000 pieces in workbench box.



Small bags

This option is attractive for small series production: 100 / 50 pieces in a polythene bag ideal for display and point-of sale promotion (Rack).

100 pieces (Sizes from 2.4 mm to 4.8 mm wide)

50 pieces (Size 7.0 mm and 7.6 mm wide)

Product Ref. information

Add "5" and "R" to the Product Ref.

Example: TY523MR

= TY23M in 100 pieces bag
with Euroslot.





To the standard Product Reference, you can add special order codes for: material, packaging size, material properties and colours.

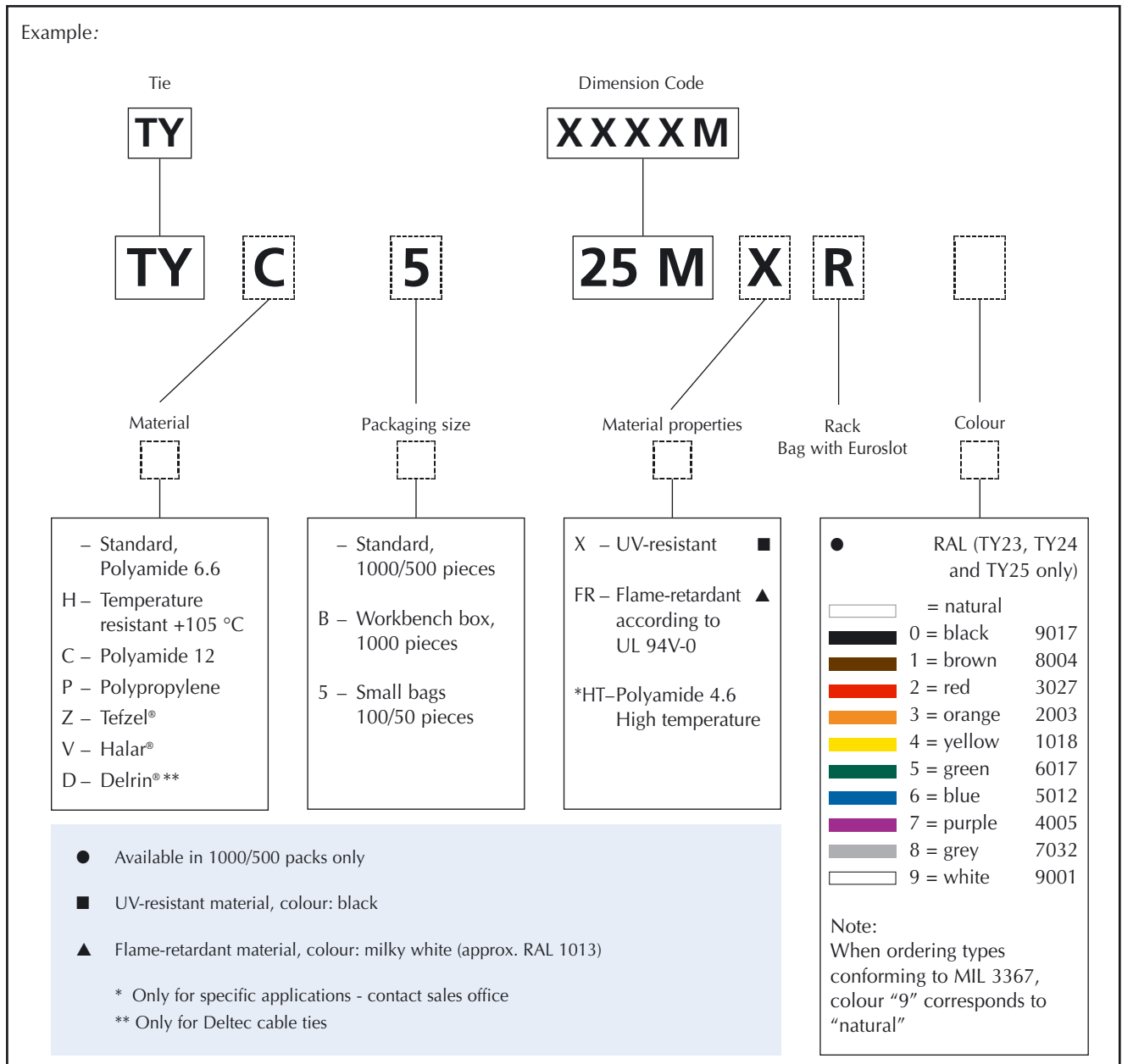

Tefzel® and Delrin® are registered trademark of DuPont de Nemours
Halar® is a registered trademark of Solvay Solexis

Ty-Rap®

Premium cable ties with steel locking barb Standard ties

Product overview

The main characteristics of the Ty-Rap® cable ties are shown on pages 8 and 9.

To cover the most demanding applications, the standard Ty-Rap® cable ties are available in:

- Several lengths
- 6 typical widths, with a tensile strength up to 780N
- 6 different materials, with a total of 9 different grades (see pages 102 to 109 for material specifications & selection)
- Several colours and packaging sizes (see page 10)



Approvals



E49405

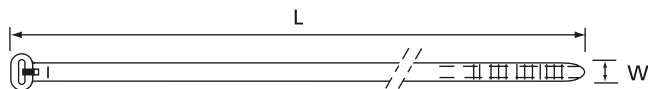

Technical Information

Material	Polyamide 6.6
Temperature range	-40°C to +85°C
Colour	Natural
Flammability rating	UL 94 V-2
Other properties	Halogen free, Silicone free

Ordering Information: Standard Polyamide 6.6 cable ties

PRODUCT REF.	MIL SPEC.	LENGTH	WIDTH	THICKNESS	BUNDLE DIAMETER	MINIMUM TENSILE STRENGTH	QUANTITY	TOOLING
		L [mm]	W [mm]					
TY23M / TYB23M	MS-3367-4	92	2.4	1.0	2 - 16	80	1000	
TYB2315M	-	178	2.4	1.0	2 - 32	80	1000	
TY232M	-	203	2.4	1.0	2 - 50	80	1000	ERG299
TY234M	-	356	2.4	1.0	2 - 102	80	1000	WT193A
TY24M / TYB24M	MS-3367-5	140	3.6	1.1	2 - 29	180	1000	TR227
TY242M	-	208	3.6	1.1	2 - 50	180	1000	
TY26M	-	284	3.6	1.1	2 - 76	130	1000	
TY244M	-	368	3.6	1.1	2 - 103	130	1000	
TY25M / TYB25M	MS-3367-1	186	4.8	1.1	3.5 - 45	220	1000	ERG299, ERG297
TY253M	MS-3367-7	290	4.8	1.1	3.5 - 78	220	1000	WT193A
TY28M	MS-3367-2	360	4.8	1.1	3.5 - 102	220	1000	TR227
TY271M	-	150	7.6	1.5	6 - 31	540	500	
TY272M	-	222	7.6	1.6	6 - 50	540	500	
TY27M	MS-3367-3	340	7.0	1.6	6 - 90	540	500	L-500-EU
TY275M	-	457	7.0	1.6	6 - 127	540	500	ERG297
TY277M	-	617	7.0	1.6	6 - 177	540	500	
TY29M	MS-3367-6	771	7.6	1.6	6 - 229	540	500	
TY53510M	-	889	8.1	1.7	to 254	780	50	WT3D
TY54513M	-	1143	8.1	1.7	to 330	780	50	L-500-EU

Available in other colours: see page 10 for description of colours and packaging sizes

Description of materials and properties: see pages 102 to 109

For tooling specifications, see pages 92 to 99



Ty-Rap[®]

Premium cable ties with steel locking barb Standard ties



Approvals



E49405

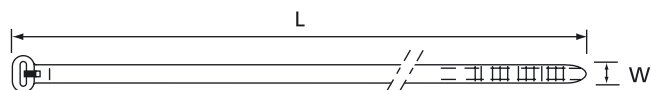

Technical Information

Material	Polyamide 6.6
Temperature range	-40°C to +85°C
Colour	Black
Flammability rating	UL 94 V-2
Other properties	UV-resistant, Halogen free, Silicone free

Ordering Information: Polyamide 6.6 UV-stabilised cable ties

PRODUCT REF.	MIL SPEC.	LENGTH	WIDTH	THICKNESS	BUNDLE DIAMETER	MINIMUM TENSILE STRENGTH	QUANTITY	TOOLING
		L [mm]	W [mm]					
TY23MX / TYB23MX	MS-3367-4	92	2.4	1.0	2 - 16	80	1000	
TYB2315MX	-	178	2.4	1.0	2 - 32	80	1000	
TY232MX	-	203	2.4	1.0	2 - 50	80	1000	
TY234MX	-	356	2.4	1.0	2 - 102	80	1000	ERG299
TY24MX / TYB24MX	MS-3367-5	140	3.6	1.1	2 - 29	130	1000	WT193A
TY242MX	-	208	3.6	1.1	2 - 50	130	1000	TR227
TY26MX	-	284	3.6	1.1	2 - 76	130	1000	
TY244MX	-	368	3.6	1.1	2 - 103	130	1000	
TY25MX / TYB25MX	MS-3367-1	186	4.8	1.1	3.5 - 45	220	1000	ERG297
TY253MX	MS-3367-7	290	4.8	1.1	3.5 - 78	220	1000	ERG299
TY28MX	MS-3367-2	360	4.8	1.1	3.5 - 102	220	1000	WT193A, TR227
TY271MX	-	150	7.6	1.5	6 - 31	540	500	
TY272MX	-	222	7.6	1.6	6 - 50	540	500	
TY27MX	MS-3367-3	340	7.0	1.6	6 - 90	540	500	L-500-EU
TY275MX	-	457	7.0	1.6	6 - 127	540	500	ERG297
TY277MX	-	617	7.0	1.6	6 - 177	540	500	
TY29MX	MS-3367-6	771	7.6	1.6	6 - 229	540	500	
TY53510MX	-	889	8.1	1.7	to 254	780	50	WT3D
TY54513MX	-	1143	8.1	1.7	to 330	780	50	L-500-EU

Description of packing sizes: see page 10

Description of materials and properties: see pages 102 to 109

For tooling specifications, see pages 92 to 99

Approvals



E49405

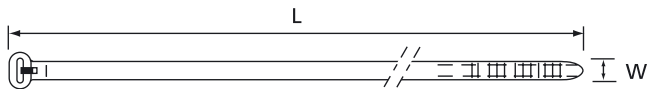

Technical Information

Material	Polyamide 6.6
Temperature range	-40°C to +85°C
Colour	White
Flammability rating	UL 94 V-0
Other properties	Halogen free, Silicone free

Ordering Information: Polyamide 6.6 flame retardant cable ties

PRODUCT REF.	LENGTH L [mm]	WIDTH W [mm]	THICKNESS [mm]	BUNDLE DIAMETER FROM ... TO [mm]	MINIMUM TENSILE STRENGTH [N]	QUANTITY [pieces]	TOOLING
TY23MFR	92	2.4	1.0	2 - 16	80	1000	ERG299
TY232MFR	203	2.4	1.0	2 - 50	80	1000	WT193A
TY24MFR	140	3.6	1.1	2 - 29	180	1000	TR227
TY25MFR	186	4.8	1.1	3.5 - 45	220	1000	ERG299, ERG297
TY28MFR	360	4.8	1.1	3.5 - 102	220	1000	WT193A, TR227
TY27MFR	340	7.0	1.6	6 - 90	540	500	L-500-EU, ERG297

Approvals



E49405

Technical Information

Material	Polyamide 6.6
Temperature range	-40°C to +105°C
Colour	Natural (may have a greenish tint)
Flammability rating	UL 94 V-2
Other properties	Halogen free, Silicone free

Ordering Information: Polyamide 6.6 heat stabilised cable ties

PRODUCT REF.	LENGTH L [mm]	WIDTH W [mm]	THICKNESS [mm]	BUNDLE DIAMETER FROM ... TO [mm]	MINIMUM TENSILE STRENGTH [N]	QUANTITY [pieces]	TOOLING
TYH23M / TYHB23M	92	2.4	1.0	2 - 16	80	1000	
TYH232M	203	2.4	1.0	2 - 50	80	1000	ERG299
TYH24M	140	3.6	1.1	2 - 29	130	1000	WT193A
TYH242M	208	3.6	1.1	2 - 50	130	1000	TR227
TYH26M	284	3.6	1.1	2 - 76	130	1000	
TYH25M	186	4.8	1.1	3.5 - 45	220	1000	ERG297
TYH253M	290	4.8	1.1	3.5 - 78	220	1000	ERG299
TYH28M	360	4.8	1.1	3.5 - 102	220	1000	WT193A, TR227
TYH272M	222	7.6	1.6	6 - 50	540	500	L-500-EU
TYH27M	340	7.0	1.6	6 - 90	540	500	ERG297
TYH29M	771	7.6	1.6	6 - 229	540	500	

Description of packing sizes: see page 10

Description of materials and properties: see pages 102 to 109

For tooling specifications, see pages 92 to 99

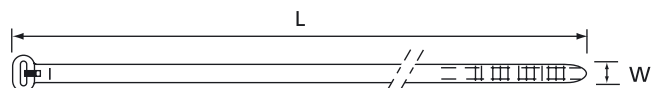

Technical Information

Material	Polyamide 12
Temperature range	-40°C to +80°C
Colour	Black
Flammability rating	UL 94 V-2
Other properties	UV-resistant, Halogen free, Silicone free

Ordering Information: Polyamide 12 UV-resistant cable ties

PRODUCT REF.	LENGTH L [mm]	WIDTH W [mm]	THICKNESS [mm]	BUNDLE DIAMETER FROM ... TO [mm]	MINIMUM TENSILE STRENGTH [N]	QUANTITY [pieces]	TOOLING
TYC25MX	186	4.8	1.1	3.5 - 45	150	1000	ERG297
TYC28MX	360	4.8	1.1	3.5 - 102	150	1000	ERG299
TYC525MX	186	4.8	1.1	3.5 - 45	150	100	WT193A, TR227
TYC272MX	222	7.6	1.6	6 - 50	380	500	L-500-EU
TYC27MX	340	7.0	1.6	6 - 90	380	500	ERG297
TYC29MX	771	7.6	1.6	6 - 229	380	500	

Technical Information

Material	Polypropylene
Temperature range	-40°C to +85°C
Colour	Black
Flammability rating	UL 94 HB
Other properties	UV-resistant, Halogen free, Silicone free

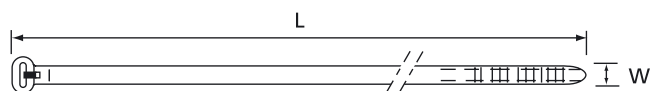

Ordering Information: Polypropylene weatherable cable ties

PRODUCT REF.	LENGTH L [mm]	WIDTH W [mm]	THICKNESS [mm]	BUNDLE DIAMETER FROM ... TO [mm]	MINIMUM TENSILE STRENGTH [N]	QUANTITY [pieces]	TOOLING
TYP25MX	186	4.8	1.1	3.5 - 45	130	1000	ERG297, ERG299
TYP28MX	360	4.8	1.1	3.5 - 102	130	1000	WT193A, TR227
TYP27MX	340	7.0	1.6	6 - 90	270	500	L-500-EU, ERG297

Approvals



E49405

Technical Information

Material	Halar®
Temperature range	-46°C to +140°C
Colour	Maroon
Flammability rating	UL 94 V-0
Other properties	UV-resistant, low smoke

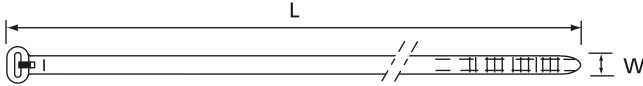

Ordering Information: Halar® cable ties

PRODUCT REF.	LENGTH L [mm]	WIDTH W [mm]	THICKNESS [mm]	BUNDLE DIAMETER FROM ... TO [mm]	MINIMUM TENSILE STRENGTH [N]	QUANTITY [pieces]	TOOLING
TYV23M	92	2.4	1.0	2 - 16	80	1000	ERG299
TYV523M	92	2.4	1.0	2 - 16	80	100	WT193A, TR227
TYV25M	186	4.8	1.1	3.5 - 45	220	1000	ERG299, ERG297
TYV525M	186	4.8	1.1	3.5 - 45	220	100	WT193A, TR227

Halar® is a registered trademark of Solvay Solexis

Description of packing sizes: see page 10

Description of materials and properties: see pages 102 to 109

For tooling specifications, see pages 92 to 99

Approvals



E49405

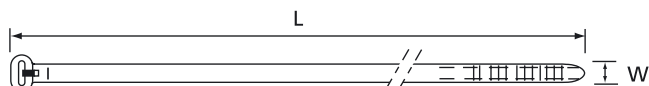

Technical Information

Material	Tefzel [®] **
Temperature range	-46°C to +150°C
Colour	Aquamarine
Flammability rating	UL 94 V-0
Other properties	UV-resistant, Halogen free, Silicone free, inert to most solvents and chemicals, hydrolytically stable, radiation resistant. Non-outgassing properties for zero gravity applications.

Ordering Information: Tefzel[®]** cable ties

PRODUCT REF.	LENGTH L [mm]	WIDTH W [mm]	THICKNESS [mm]	BUNDLE DIAMETER FROM ... TO [mm]	MINIMUM TENSILE STRENGTH [N]	QUANTITY [pieces]	TOOLING
TYZ23M*	92	2.4	1.0	2 - 16	80	1000	WT193A, TR227
TYZ25M	186	4.8	1.1	3.5 - 45	220	1000	ERG299
TYZ28M	360	4.8	1.1	3.5 - 102	220	1000	ERG297***
TYZ27M	340	7.0	1.6	6 - 90	540	500	L-500-EU, ERG297

* Product Ref. TYZ23M is UL listed (E49405)

** Tefzel is a registered trademark of DuPont de Nemours

*** ERG297 not to be used on TYZ23M

Description of packing sizes: see page 10

Description of materials and properties: see pages 102 to 109

For tooling specifications, see pages 92 to 99

Thomas & Betts has developed a range of special Ty-Rap® cable ties, having the same main characteristics as the standard ties like the stainless steel locking barb (see pages 8 and 9), plus some additional features to provide an appropriate and elegant solution to some specific applications.

Special ties with mounting hole

- Can be directly mounted onto a support with screws, bolts or rivets
- Mounting and bundling in one maintenance-friendly assembly.
- Available in different versions with different positioning of mounting hole

Typical applications

Cable harness manufacture and pre- and end- mounting of bundles and parts. Maintenance friendly mounting of cables, tubes and parts in all types and sizes of machines and installations - indoor and outdoor.

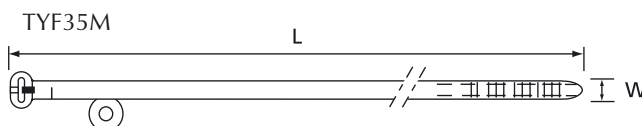
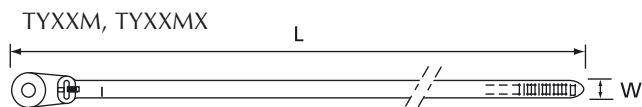

Ordering Information

PRODUCT REF.	COLOUR	DIAMETER OF MOUNTING HOLE [mm]	LENGTH L [mm]	WIDTH W [mm]	THICKNESS [mm]	BUNDLE DIAMETER FROM ... TO [mm]	MINIMUM TENSILE STRENGTH [N]	QUANTITY [pieces]	TOOLING
TY33M	natural	3.0	102	2.3	0.9	2 - 16	80	1000	
TY33MX	UV-resistant black	3.0	102	2.3	0.9	2 - 16	80	1000	ERG299 TR227
TY34M	natural	4.4	151	3.5	1.0	2 - 29	180	1000	WT193A
TY34MX	UV-resistant black	4.4	151	3.5	1.0	2 - 29	180	1000	
TY635M	natural	4.0	198	4.7	1.1	3.5 - 45	220	1000	
TY635MX	UV-resistant black	4.0	198	4.7	1.1	3.5 - 45	220	1000	ERG297
TY35M	natural	5.1	199	4.7	1.1	3.5 - 45	220	1000	ERG299
TY35MX	UV-resistant black	5.1	199	4.7	1.1	3.5 - 45	220	1000	TR227
TY1435M	natural	6.7	198	4.7	1.1	3.5 - 45	220	1000	WT193A
TY37M	natural	6.7	356	7.7	2.0	6 - 90	540	500	ERG297, L-500-EU
TYF35M	natural	4.0	186	4.7	1.2	3.5 - 45	220	1000	ERG297, ERG299 TR227, WT193A

* UL recognition not applicable for UV-resistant black version
For tooling specifications, see pages 92 to 99



Technical Information

Material - Moulding	Polyamide 6.6
Material - Locking barb	316 grade stainless steel
Temperature range	-40°C to +85°C
Colour	Natural or UV-resistant black (see table)
Flammability rating	UL 94 V-2
Other properties	UV-resistant (black), Halogen free Silicone free

Approvals



E49405*

VG
approved

VG95387
part 4, type B



Ty-Rap[®]

Premium cable ties with steel locking barb
Special ties with integrated
panel-mounting, anchor type

- Fastening and clip-mounting in one
- Fast pre- or on-site-assembly for a range of panel thickness up to 4.0 mm
- Fast and secure clip-mounting



Approvals



E49405*

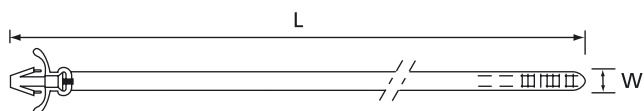

Technical Information

Material - Moulding	Polyamide 6.6
Material - Locking barb	316 grade stainless steel
Temperature range	-40°C to +85°C
Colour	Natural or UV-resistant black (see table)
Flammability rating	UL 94 V-2
Other properties	UV-resistant (black), Halogen free Silicone free

Ordering Information

PRODUCT REF.	COLOUR	DIAMETER OF MOUNTING HOLE [mm]	LENGTH L [mm]	WIDTH W [mm]	THICKNESS [mm]	BUNDLE DIAMETER FROM ... TO [mm]	MINIMUM TENSILE STRENGTH [N]	SUITABLE FOR BOARD/WALL THICKNESS FROM TO [mm]	QUANTITY [pieces]	TOOLING
TY54SM	natural	4.5 - 5.2	150	3.5	1.0	2 - 32	130	0.1 - 2.5	1000	ERG299
TY54SMX	UV-resistant black	4.5 - 5.2	150	3.5	1.0	2 - 32	130	0.1 - 2.5	1000	WT193A
TY38M	natural	6.4 - 6.7	200	4.7	1.3	3.5 - 44	220	1.0 - 4.0	1000	TR227
TY38MX	UV-resistant black	6.4 - 6.7	200	4.7	1.3	3.5 - 44	220	1.0 - 4.0	1000	ERG297**

* UL recognised for TY38M only

** ERG297: only for reference TY38M and TY38MX

For tooling specifications see pages 92 to 99

Ty-Rap®

Premium cable ties with steel locking barb
Special ties with integrated
panel-mounting

- Fastening and clip-mounting in one
- Fast pre- or on-site-assembly for different panel thickness up to 3.7 mm
- Fast and secure clip-mounting



Technical Information

Material - Moulding	Polyamide 6.6
Material - Locking barb	316 grade stainless steel
Temperature range	-40°C to +85°C
Colour	Natural or UV-resistant black (see table)
Flammability rating	UL 94 V-2
Other properties	UV-resistant (black), Halogen free Silicone free

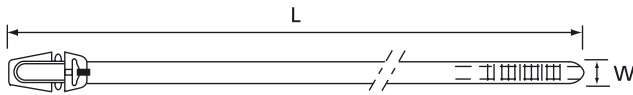

Ordering Information

PRODUCT REF.	COLOUR	DIAMETER OF MOUNTING HOLE [mm]	LENGTH L [mm]	WIDTH W [mm]	THICKNESS [mm]	BUNDLE DIAMETER FROM ... TO [mm]	MINIMUM TENSILE STRENGTH [N]	SUITABLE FOR BOARD/WALL THICKNESS FROM TO [mm]	QUANTITY [pieces]	TOOLING
696-41836X	UV-resistant black	5.8 - 7.5	197	4.8	1.1	3.5 - 45	220	2.2 - 3.7	1000	WT193A, TR227

For tooling specifications see pages 92 to 99



Ty-Rap[®]

Premium cable ties with steel locking barb Special ties for blind mounting

- Suitable for hard-to-reach areas
- Fast hidden mounting on walls and vehicle chassis
- Twist off the locking head
- Pull the tie end through the fastening hole
- Place locking head on tie end
- Pull tight and cut off excess
- In the locked state, the locking head neatly covers the mounting hole

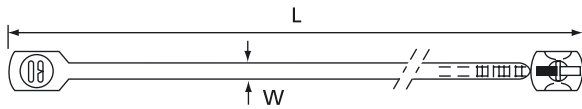
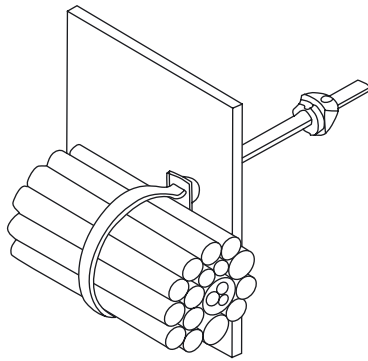

Technical Information

Material - Moulding	Polyamide 6.6
Material - Locking barb	316 grade stainless steel
Temperature range	-40°C to +85°C
Colour	Natural or UV-resistant black (see table)
Flammability rating	UL 94 V-2
Other properties	UV-resistant (black), Halogen free Silicone free

Approvals



E49405

Ordering Information

PRODUCT REF.	COLOUR	DIAMETER OF MOUNTING HOLE [mm]	LENGTH L [mm]	WIDTH W [mm]	THICKNESS [mm]	BUNDLE DIAMETER FROM ... TO [mm]	MINIMUM TENSILE STRENGTH [N]	QUANTITY [pieces]	TOOLING
TYG34M	natural	6.4 - 7.0	160	3.6	1.1	2 - 32	180	1000	ERG299 WT193A
TYG534M	natural	6.4 - 7.0	160	3.6	1.1	2 - 32	180	100	
TYG34MX	UV-resistant black	6.4 - 7.0	160	3.6	1.1	2 - 32	180	1000	TR227
TYG534MX	UV-resistant black	6.4 - 7.0	160	3.6	1.1	2 - 32	180	100	

For tooling specifications see pages 92 to 99

Ty-Rap[®]

Premium cable ties

Special ties for blind mounting

- Suitable for hard-to-reach areas
- Fast hidden mounting on walls and vehicle chassis
- Ideal for mounting on vehicle chassis. Can still be released before final tensioning
- In the locked state, the locking head neatly covers the mounting hole

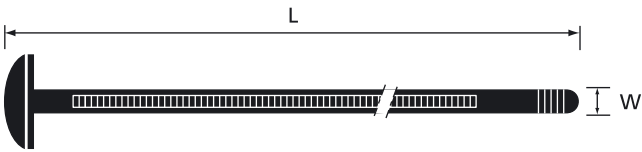
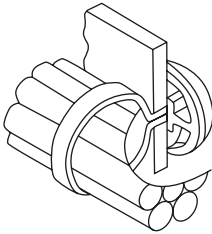
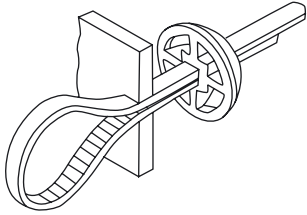

Technical Information

Material - Moulding	Polyamide 6.6
Temperature range	-40°C to +85°C
Colour	UV-resistant black
Flammability rating	UL 94 V-2
Other properties	UV-resistant, Halogen free, Silicone free

Ordering Information

PRODUCT REF.	DIAMETER OF MOUNTING HOLE [mm]	LENGTH L [mm]	WIDTH W [mm]	THICKNESS [mm]	BUNDLE DIAMETER FROM ... TO [mm]	MINIMUM TENSILE STRENGTH [N]	QUANTITY [pieces]	TOOLING
TY41M	8.1 - 17.3	244	5.7	1.7	5 - 60	300	500	ERG297

For tooling specifications, see pages 92 to 99



Ty-Rap®

Premium cable ties with steel locking barb
Special ties with integrated peg / nail

- TY545MX, with integrated nail for mounting onto wood or similar materials
- TY844MX, with integrated peg for mounting onto porous concrete or similar materials (masonry)
- Very simple application

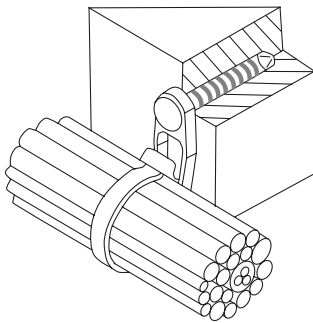

Technical Information

Material - Moulding	Polyamide 6.6
Material - Locking barb	316 grade stainless steel
Temperature range	-40°C to +85°C
Colour	UV-resistant black
Flammability rating	UL 94 V-2
Other properties	UV-resistant, Halogen free, Silicone free

TY844MX



TY545MX



Ordering Information

PRODUCT REF.	DIAMETER OF MOUNTING HOLE [mm]	LENGTH L [mm]	WIDTH W [mm]	THICKNESS [mm]	BUNDLE DIAMETER FROM ... TO [mm]	MINIMUM TENSILE STRENGTH [N]	MOUNTING HOLE DEPTH [mm]	QUANTITY [pieces]	TOOLING
TY844MX	6.4	200	4.6	1.0	3.5 - 45	220	25 min.	50	ERG297, ERG299
TY545MX	-	200	4.7	1.0	4.7 - 38.1	220	-	50	WT193A, TR227

For tooling specifications see page 92 to 99

Ty-Rap®

Premium cable ties

Special releasable ties

- For temporary but strong bundling, especially during control box wiring
- Very simple application
- Available in 2 lengths for different applications
- May be re-used many times
- No tooling necessary

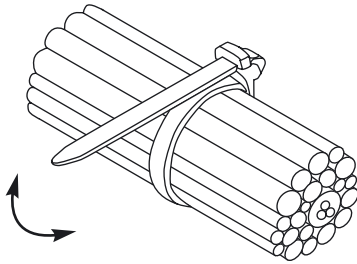

Pull end of tie through head. Turn tie end back on itself and insert into side of clip.
To open, release tie end from clip and open tie.

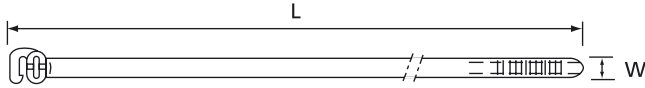

Technical Information

Material	Polyamide 6.6
Temperature range	-40°C to +85°C
Colour	Natural
Flammability rating	UL 94 V-2
Other properties	Halogen free, Silicone free

Ordering Information

PRODUCT REF.	LENGTH L [mm]	WIDTH W [mm]	THICKNESS [mm]	BUNDLE DIAMETER FROM ... TO [mm]	MINIMUM TENSILE STRENGTH [N]	QUANTITY [pieces]
TYR505	190	4.7	1.19	10 - 44	220	100
TYR508	364	4.7	1.19	10 - 102	220	100



Ty-Rap[®]

Premium cable ties

Special lashing ties with incorporated fastener

- Rugged one-piece construction, for heavy-duty applications
- Releasable and re-usable, ideal for temporary installations
- Fast and durable
- Easy handling
- No tooling necessary
- Specially developed accessories, like the wall plug TC5359 and the mounting bases TC5355 to TC5357 (see page 71 for details)

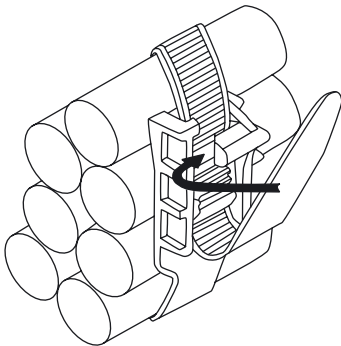

Introduce the cable tie tail into the lower slot in the head. Tighten the tie and pull it back. Slide in the tie under the catch from the side until it snaps into position.

Technical Information

Material	Polyamide 6.6
Temperature range	-40°C to +85°C
Colour	UV-resistant black
Flammability rating	UL 94 V-2
Other properties	UV-resistant, Halogen free, Silicone free

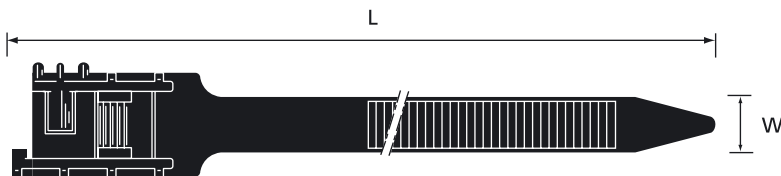

Ordering Information

PRODUCT REF.	LENGTH L [mm]	WIDTH W [mm]	THICKNESS [mm]	BUNDLE DIAMETER FROM ... TO [mm]	MINIMUM TENSILE STRENGTH [N]	QUANTITY [pieces]
TY409	483	12.7	2.0	45 - 121	890	100
TY5409	483	12.7	2.0	45 - 121	890	25

Ty-Rap®

Premium cable ties

Special 2-piece lashing ties,
pre-assembled version

- Heavy-duty lashing ties, in cut lengths with pre-assembled heads
- Also available on reel with separate heads (see page 26)
- UV-resistant Polypropylene, ideal for applications where chemical resistance is important (heads in weatherable rigid Polyamide 6.6)
- Extremely robust (670N)
- Easily releasable & reusable
- 2 types of head: type A: no mounting hole
type B: with mounting hole

Typical applications

- Indoor and outdoor fastening of cables, pipes and other parts in industry, shipbuilding, chemical industry etc.

TY54XXPX

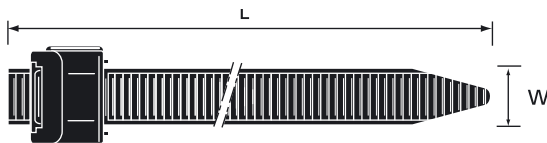
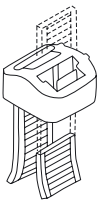

TY53418PX

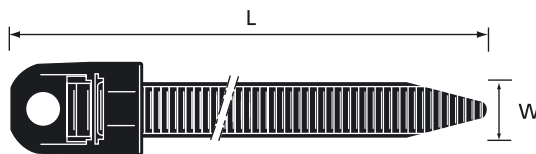
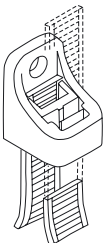

Technical Information

Material - Tie	Weatherable Polypropylene
Material - Head	Polyamide 6.6
Temperature range	Head: -40°C to +85°C Tie: -55°C to +110°C
Colour	UV-resistant black
Flammability rating	UL 94 V-2
Other properties	UV-resistant, Halogen free

Ordering Information

PRODUCT REF.	DIAMETER OF MOUNTING HOLE [mm]	LENGTH L [mm]	WIDTH W [mm]	THICKNESS [mm]	BUNDLE DIAMETER FROM ... TO [mm]	MINIMUM TENSILE STRENGTH [N]	QUANTITY [pieces]
TY53418PX	6.9	457	13.2	1.9	45 - 127	670	25
TY5418PX	-	457	13.2	1.8	45 - 127	670	25
TY5424PX	-	610	13.2	1.8	10 - 178	670	25
TY5442PX	-	1067	13.2	1.8	10 - 305	670	10
TY5460PX	-	1524	13.2	1.8	10 - 457	670	10

- Heavy-duty lashing ties on reel with separate heads
- Also available in cut lengths with pre-assembled heads (see page 25)
- UV-resistant Polypropylene, ideal for applications where chemical resistance is important (heads in weatherable rigid Polyamide 6.6)
- Extremely robust (670N)
- Easily releasable & reusable
- 2 types of head:
 - type A: no mounting hole
 - type B: with mounting hole

Typical applications

- Indoor and outdoor fastening of cables, pipes and other parts in industry, shipbuilding, chemical industry etc.
- **Product Ref. 696-41563:** lashing tie on reel (300 m), in weatherable Polypropylene
- **Product Ref. 696-41562:** separate head, type A (no mounting hole), weatherable Polyamide 6.6 (200 pieces)
- **Product Ref. 696-41614:** separate head, type B (with mounting hole), weatherable Polyamide 6.6 (200 pieces)
Mounting hole: Ø 6.9 mm
- **Product Ref. TY4100PX:** kit containing 30 m of lashing tie on reel + 50 separate heads, type A



Technical Information

Material - Tie	Weatherable Polypropylene
Material - Head	Polyamide 6.6
Temperature range	Head: -40°C to +85°C Tie: -55°C to +110°C
Colour	UV-resistant black
Flammability rating	UL 94 V-2
Other properties	UV-resistant, Halogen free



696-41563

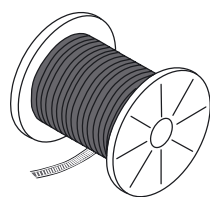

696-41563

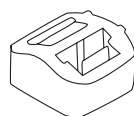

696-41562

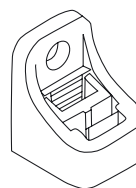

696-41614

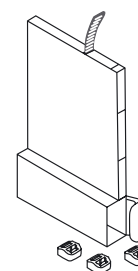

TY4100PX

Ordering Information

PRODUCT REF.	LASHING TIE, DIMENSIONS			SEPARATE LOCKING HEADS		MIN. TENSILE STRENGTH OF ASSEMBLY [N]
	LENGTH [m]	WIDTH [mm]	THICKNESS [mm]	QUANTITY [pieces]	TYPE	
696-41563	300	13.2	1.8	–	–	670
696-41562	–	–	–	200	Type A, no mounting hole	670
696-41614	–	–	–	200	Type B, with mounting hole	670
TY4100PX	30	13.2	1.8	50	Type A, no mounting hole	670

- Identification ties with incorporated label for durable marking and tying
- Label forms onto the bundle for types TY512M, TY51M and protrudes for ties TY532M and TY53M
- Type 51M is MIL (MS-3368-5) approved
- Trouble-free installation
- Simple marking on the roughened writing surface using the special marking pen WT163M-1 (black ink) or WT163M-3 (red ink) - See page 29
- All edges are rounded to make installation easier



TY532M & TY53M

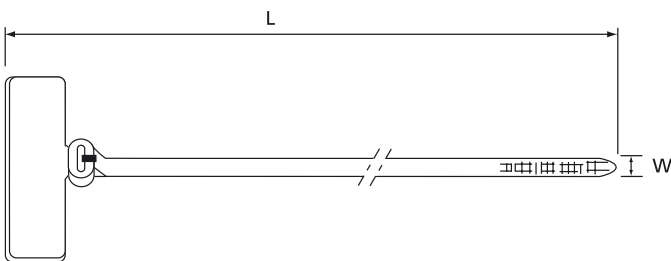

TY512M & TY51M

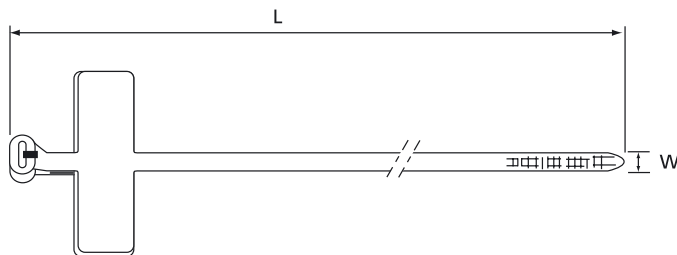

Technical Information

Material - Moulding	Polyamide 6.6
Material - Locking barb	316 grade stainless steel
Temperature range	-40°C to +85°C
Colour	Natural
Flammability rating	UL 94 V-2
Other properties	Halogen free, Silicone free

Approvals



E49405

Ordering Information

PRODUCT REF.	MIL SPEC.	LENGTH	WIDTH	THICKNESS	BUNDLE DIAMETER	MINIMUM TENSILE	LABEL	QUANTITY	TOOLING
		L	W						
		[mm]	[mm]	[mm]	FROM ... TO	STRENGTH	DIMENSIONS	[pieces]	
					[mm]	[N]	[mm]		
TY51M	MS-3368-5	92	2.4	1.0	10 - 16	80	25.4 x 7.9	500	
TY512M	-	210	2.4	1.0	10 - 51	80	25.4 x 7.9	1000	WT193A
TY53M	-	102	2.4	1.0	2 - 16	80	20.6 x 9.3	500	ERG299
TY532M	-	212	2.4	1.0	2 - 51	80	20.6 x 9.3	1000	TR227

For other materials and colours contact your Sales Office
For tooling specifications see pages 92 to 99



- Identification ties with incorporated label for durable marking and tying
- Label forms onto the bundle
- Mil-specified types with up to 3 straps
- Trouble free installation
- Labelling of bundles up to 102 mm diameter
- Simple marking on the roughened writing surface using the special marking pen WT163M-1 / WT163M-3 (black or red)
- All edges are rounded and surfaces smoothed to make installation easier



Technical Information

Material - Moulding	Polyamide 6.6
Material - Locking barb	316 grade stainless steel
Temperature range	-40°C to +85°C
Colour	Natural
Approvals	MIL: MS-3368 -1, -2, -3, -4
Flammability rating	UL 94 V-2
Other properties	Halogen free, Silicone free

Approvals



E49405

TY48M

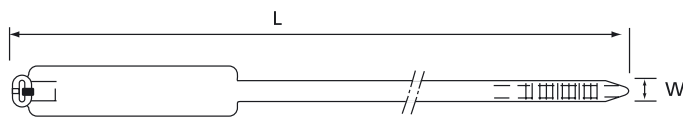

TY46M

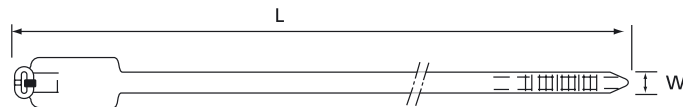

TY46MD

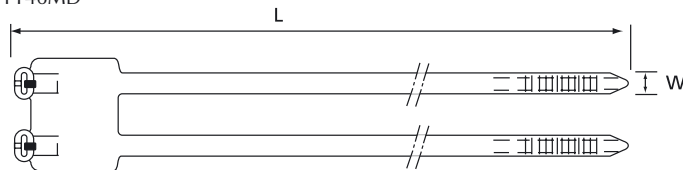

TY46MT

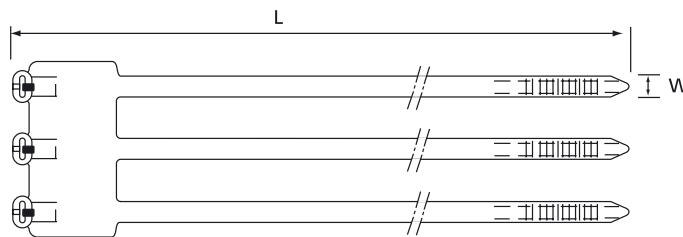

TY46MF

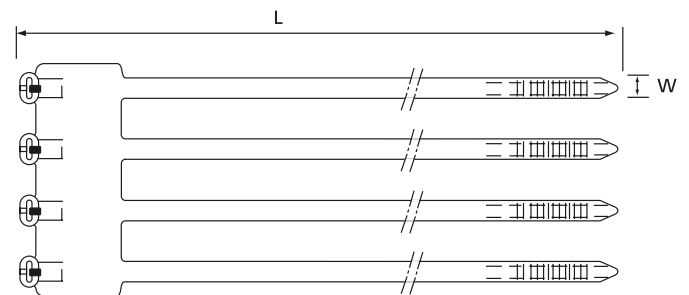

Ordering Information

PRODUCT REF.	MIL SPEC.	LENGTH L [mm]	WIDTH W [mm]	THICKNESS [mm]	BUNDLE DIAMETER FROM ... TO [mm]	MINIMUM TENSILE STRENGTH [N]	LABEL DIMENSIONS [mm]	QUANTITY [pieces]	TOOLING
TY48M	MS-3368-2	360	4.8	1.1	19 - 102	220	13.1 x 57.2	1000	
TY46M	MS-3368-1	184	4.8	1.1	9.5 - 45	220	13.1 x 27.0	1000	WT193A
TY46MD	MS-3368-3	184	4.8	1.1	9.5 - 45	220 x 2	29.7 x 27.0	500	ERC299
TY46MT	MS-3368-4	184	4.8	1.1	9.5 - 45	220 x 3	46.0 x 27.0	500	ERC297
TY46MF	-	184	4.8	1.1	9.5 - 45	220 x 4	63.1 x 27.0	250	TR227

For other materials and colours contact your Sales Office
For tooling specifications see pages 92 to 99

Ty-Rap[®]

Premium cable ties

Special marking pen

- Optimally suited for fast and long-lasting writing on Polyamide surfaces
- Fast-drying ink
- The ink is resistant to humidity, oil and light solvents
- Non toxic
- Available in 2 colours of ink

Ordering Information

PRODUCT REF.	COLOUR
WT163M-1	black ink
WT163M-3	red ink



Premium cable ties with steel locking barb Printed cable ties

Thomas & Betts extends its highly respected existing capabilities in cable tie manufacture with its in-house printing equipment in order to respond flexibly to customer requirements and to allow rapid delivery. This service is offered for ties having a width of minimum 4.6 mm (batches of minimum 10,000 ties approximately)

Technical Information

- The cable tie is printed using a Hot foil transfer process
- The print is highly durable
- The basic character set is in accordance with DIN1451- (3 mm character height)
- Text colours: Red, Orange, Yellow, Bright-Yellow, Green, Blue, Brown, Dark-Brown, Black, White

Please contact your Sales Office for other character sets and special stamping designs.



Premium cable ties Identification tags

- Tie fastening labels
- For use in combination with the special marking pen WT163M-1 & WT163M-3 from Thomas & Betts (see page 29), or with a hot foil marking
- For secure labelling of bundles, parts etc
- Available in 3 shapes to suit all design requirements

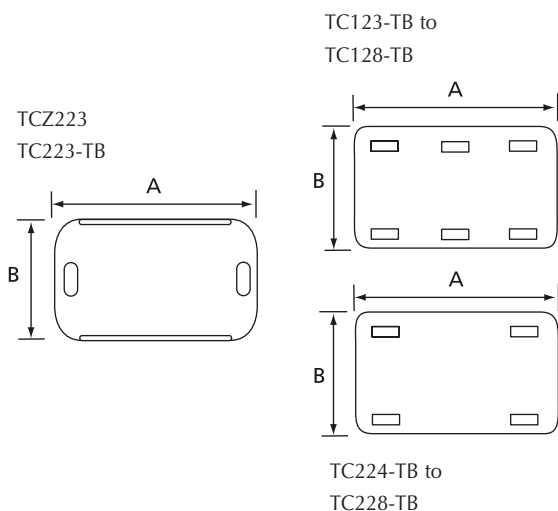

Technical Information: Prod. Ref TCZ223

Material	Tefzel®*
Temperature range	-46°C to +150°C
Colour	Aquamarine
Flammability rating	UL 94 V-0
Other properties	UV-resistant, Halogen free, Silicone free Inert to most solvents and chemicals hydrolytically stable, radiation resistant

*Tefzel® is a registered trademark of DuPont de Nemours

Technical Information: Other Prod. Ref

Material	Polyamide 6.6
Temperature range	-40°C to +85°C
Colour	Natural
Flammability rating	UL 94 V-2
Other properties	Halogen free, Silicone free

Ordering Information

PRODUCT REF.	HEIGHT	WIDTH	LABEL THICKNESS	AREA FOR LABEL		FOR TIE WIDTH	WEIGHT	QUANTITY
	A	B		HEIGHT	WIDTH	UP TO		
	[mm]	[mm]	[mm]	[mm]	[mm]	[mm]	[g/100]	[pieces]
TC123-TB	19.6	32.0	0.3	9.5	32.0	4.8	17	1000
TC124-TB	19.6	38.0	0.3	9.5	38.0	4.8	18	1000
TC125-TB	19.6	44.7	0.3	9.5	44.7	4.8	19	1000
TC126-TB	19.6	51.0	0.3	9.5	51.0	4.8	31	1000
TC128-TB	19.6	63.5	0.3	9.5	63.5	4.8	35	1000
TC223-TB	19.6	32.3	1.0	18.0	24.0	4.8	37	1000
TCZ223	19.6	32.3	1.0	18.0	24.0	4.8	50	1000
TC224-TB	19.6	38.0	0.5	9.5	38.0	4.8	34	1000
TC225-TB	19.6	44.7	0.5	9.5	44.7	4.8	40	1000
TC226-TB	19.6	51.0	0.5	9.5	51.0	4.8	39	1000
TC228-TB	19.6	63.5	0.5	9.5	63.5	4.8	51	1000