

Analog Devices Welcomes Hittite Microwave Corporation

NO CONTENT ON THE ATTACHED DOCUMENT HAS CHANGED



THIS PAGE INTENTIONALLY LEFT BLANK

Typical Applications

The HMC580ST89 / HMC580ST89E is ideal for:

- Cellular / PCS / 3G
- Fixed Wireless & WLAN
- CATV, Cable Modem & DBS
- Microwave Radio & Test Equipment
- IF & RF Applications

Features

- P1dB Output Power: +22 dBm
- Gain: 22 dB
- Output IP3: +37 dBm
- Cascadable 50 Ohm I/Os
- Single Supply: +5V
- Industry Standard SOT89 Package

Functional Diagram

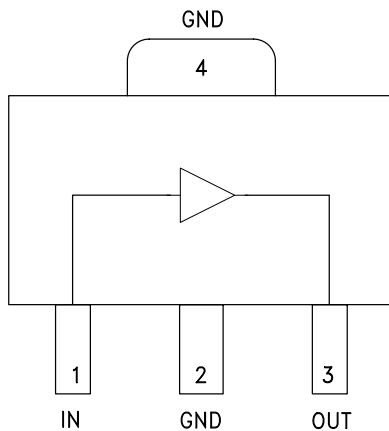

General Description

The HMC580ST89 & HMC580ST89E are InGaP Heterojunction Bipolar Transistor (HBT) Gain Block MMIC SMT amplifiers covering DC to 1 GHz. Packaged in an industry standard SOT89, the amplifier can be used as a cascadable 50 Ohm RF or IF gain stage as well as a PA or LO driver with up to +26 dBm output power. The HMC580ST89(E) offers 22 dB of gain with a +37 dBm output IP3 at 250 MHz, and can operate directly from a +5V supply. The HMC580ST89(E) exhibits excellent gain and output power stability over temperature, while requiring a minimal number of external bias components.

Electrical Specifications, $V_s = 5V$, $R_{bias} = 1.8 \text{ Ohm}$, $T_A = +25^\circ \text{ C}$

Parameter	Min.	Typ.	Max.	Units
Gain	DC - 0.25 GHz	19	22	dB
	0.25 - 0.50 GHz	18.5	21	dB
	0.50 - 1.00 GHz	15	17	dB
Gain Variation Over Temperature		0.005		dB/ °C
Input Return Loss	DC - 0.25 GHz		35	dB
	0.25 - 0.50 GHz		28	dB
	0.50 - 1.00 GHz		19	dB
Output Return Loss	DC - 0.50 GHz		12	dB
	0.50 - 1.00 GHz		11	dB
Reverse Isolation		23		dB
Output Power for 1 dB Compression (P1dB)	DC - 0.25 GHz	19	22	dBm
	0.25 - 0.50 GHz	17.5	20.5	dBm
	0.50 - 1.00 GHz	16	19	dBm
Output Third Order Intercept (IP3) (Pout= 0 dBm per tone, 1 MHz spacing)	DC - 0.25 GHz		37	dBm
	0.25 - 0.50 GHz		35	dBm
	0.50 - 1.00 GHz		33	dBm
Noise Figure		2.8		dB
Supply Current (Icc)		88	110	mA

Note: Data taken with broadband bias tee on device output.

For price, delivery and to place orders: Hittite Microwave Corporation, 20 Alpha Road, Chelmsford, MA 01824

Phone: 978-250-3343 Fax: 978-250-3373 Order On-line at www.hittite.com

Application Support: Phone: 978-250-3343 or apps@hittite.com

Broadband Gain & Return Loss

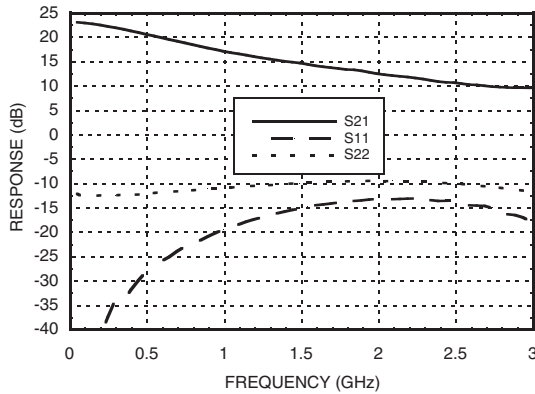

Gain vs. Temperature

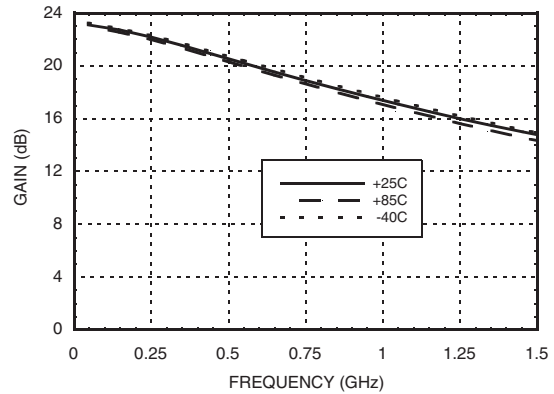

Input Return Loss vs. Temperature

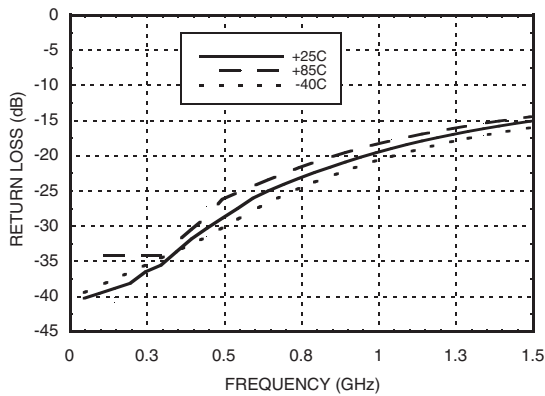

Output Return Loss vs. Temperature

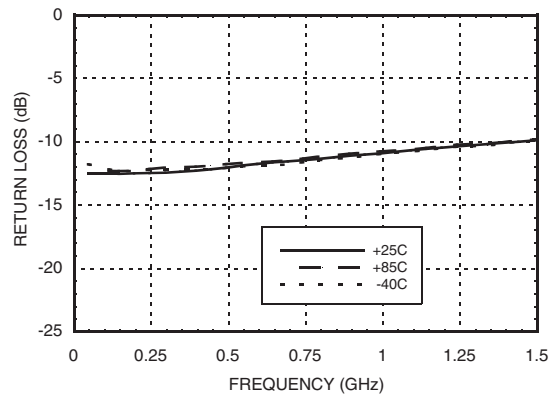

Reverse Isolation vs. Temperature

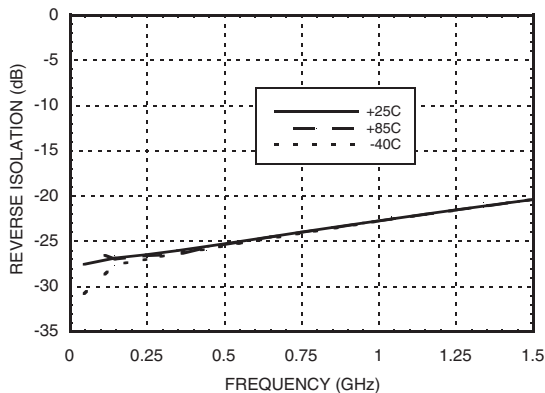

Noise Figure vs. Temperature

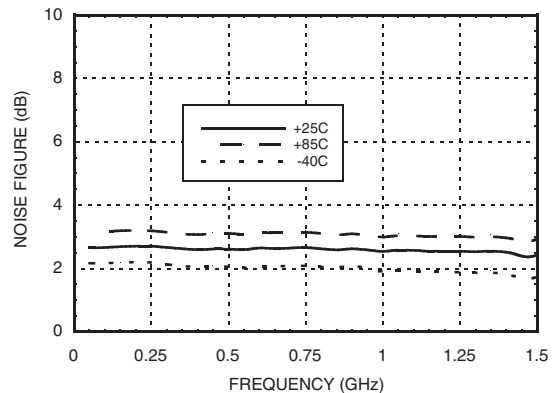



InGaP HBT GAIN BLOCK MMIC AMPLIFIER, DC - 1 GHz

8

AMPLIFIERS - DRIVER & GAIN BLOCK - SMT

P1dB vs. Temperature

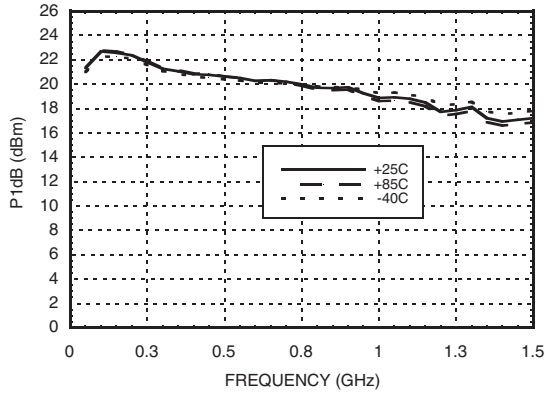

Psat vs. Temperature

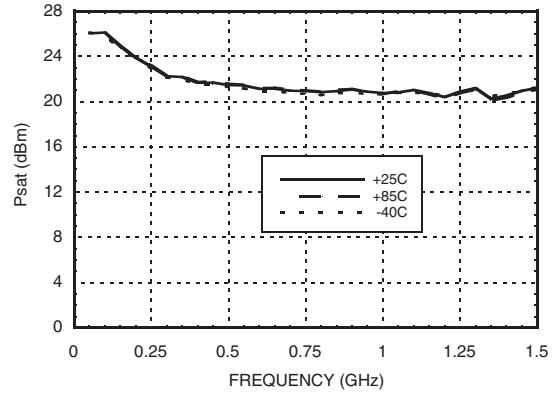

Output IP3 vs. Temperature

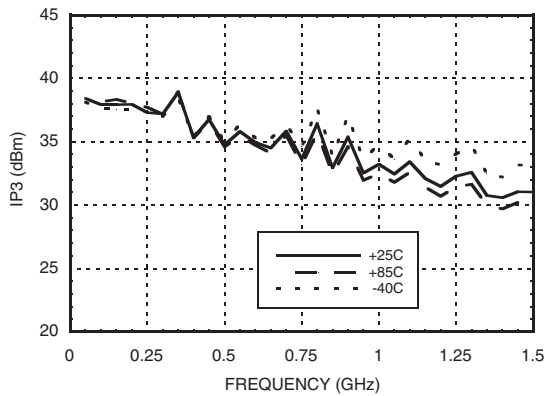

Gain, Power & OIP3 vs. Supply Voltage for Constant Icc = 88 mA @ 850 MHz

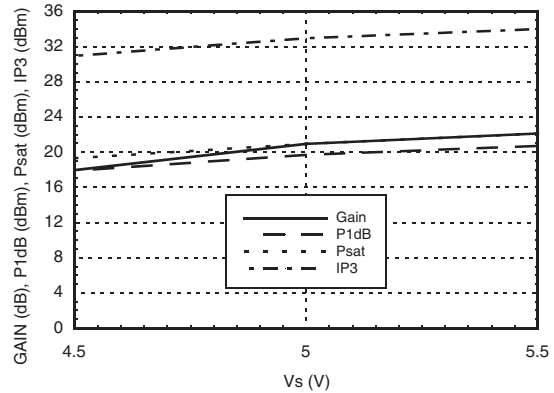

Vcc vs. Icc Over Temperature for Fixed Vs= 5V, RBIAS= 1.8 Ohms

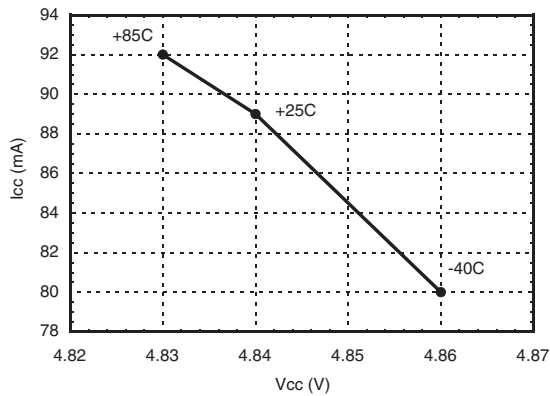

ACPR vs. Channel Output Power

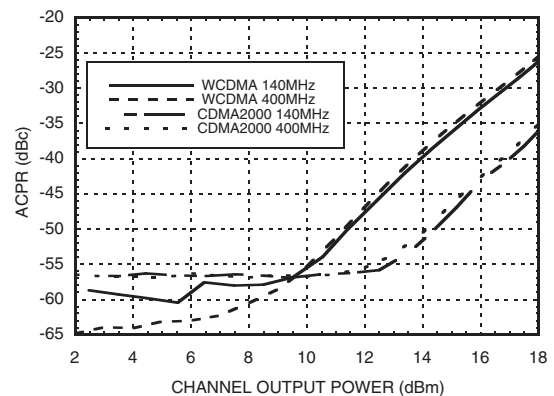

Absolute Maximum Ratings

Collector Bias Voltage (Vcc)	+5.5 Vdc
RF Input Power (RFIN)(Vcc = +4.2 Vdc)	+10 dBm
Junction Temperature	150 °C
Continuous P _{diss} (T = 85 °C) (derate 9 mW/°C above 85 °C)	0.59 W
Thermal Resistance (junction to lead)	110 °C/W
Storage Temperature	-65 to +150 °C
Operating Temperature	-40 to +85 °C
ESD Sensitivity (HMB)	Class 1C



ELECTROSTATIC SENSITIVE DEVICE
OBSERVE HANDLING PRECAUTIONS

8

Outline Drawing

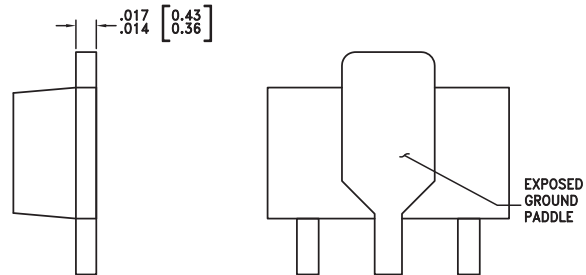
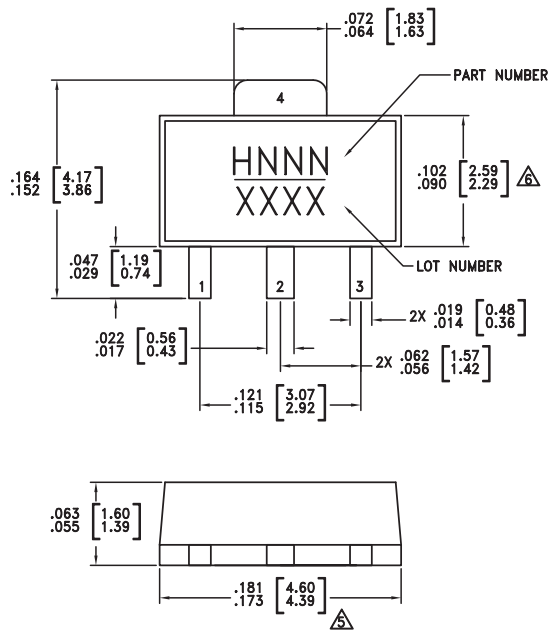

NOTES:

- PACKAGE BODY MATERIAL:
MOLDING COMPOUND MP-180S OR EQUIVALENT.
- LEAD MATERIAL: Cu w/ Ag SPOT PLATING.
- LEAD PLATING: 100% MATTE TIN.
- DIMENSIONS ARE IN INCHES [MILLIMETERS]
- Δ DIMENSION DOES NOT INCLUDE MOLDFLASH OF 0.15mm PER SIDE.
- Δ DIMENSION DOES NOT INCLUDE MOLDFLASH OF 0.25mm PER SIDE.
- ALL GROUND LEADS MUST BE SOLDERED TO PCB RF GROUND.

Package Information

Part Number	Package Body Material	Lead Finish	MSL Rating	Package Marking ^[3]
HMC580ST89	Low Stress Injection Molded Plastic	Sn/Pb Solder	MSL1 ^[1]	H580 XXXX
HMC580ST89E	RoHS-compliant Low Stress Injection Molded Plastic	100% matte Sn	MSL1 ^[2]	H580 XXXX

[1] Max peak reflow temperature of 235 °C

[2] Max peak reflow temperature of 260 °C

[3] 4-Digit lot number XXXX

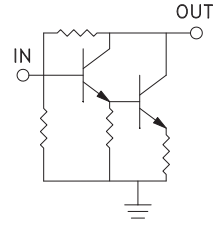

Pin Descriptions

Pin Number	Function	Description	Interface Schematic
1	IN	This pin is DC coupled. An off chip DC blocking capacitor is required.	
3	OUT	RF output and DC Bias (Vcc) for the output stage.	
2, 4	GND	These pins and package bottom must be connected to RF/DC ground.	

Application Circuit

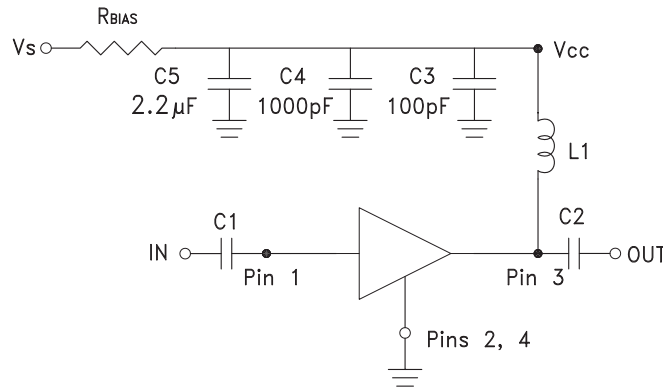

Recommended Bias Resistor Values for $I_{cc} = 88 \text{ mA}$, $R_{bias} = (V_s - V_{cc}) / I_{cc}$, $V_s > +5V$

Supply Voltage (Vs)	6V	8V
RBIAS VALUE	13 Ω	36 Ω
RBIAS POWER RATING	¼ W	½ W

Note:

- External blocking capacitors are required on RFIN and RFOUT.
- RBIAS provides DC bias stability over temperature.

Recommended Component Values for Key Application Frequencies with Vs = +5V

Component	Frequency (MHz)			
	50	250	400	900
L1	270 nH	110 nH	110 nH	56 nH
C1, C2	0.01 μF	820 pF	820 pF	100 pF
Rbias	0 Ohms	1.5 Ohms	1.5 Ohms	1.8 Ohms

Evaluation PCB

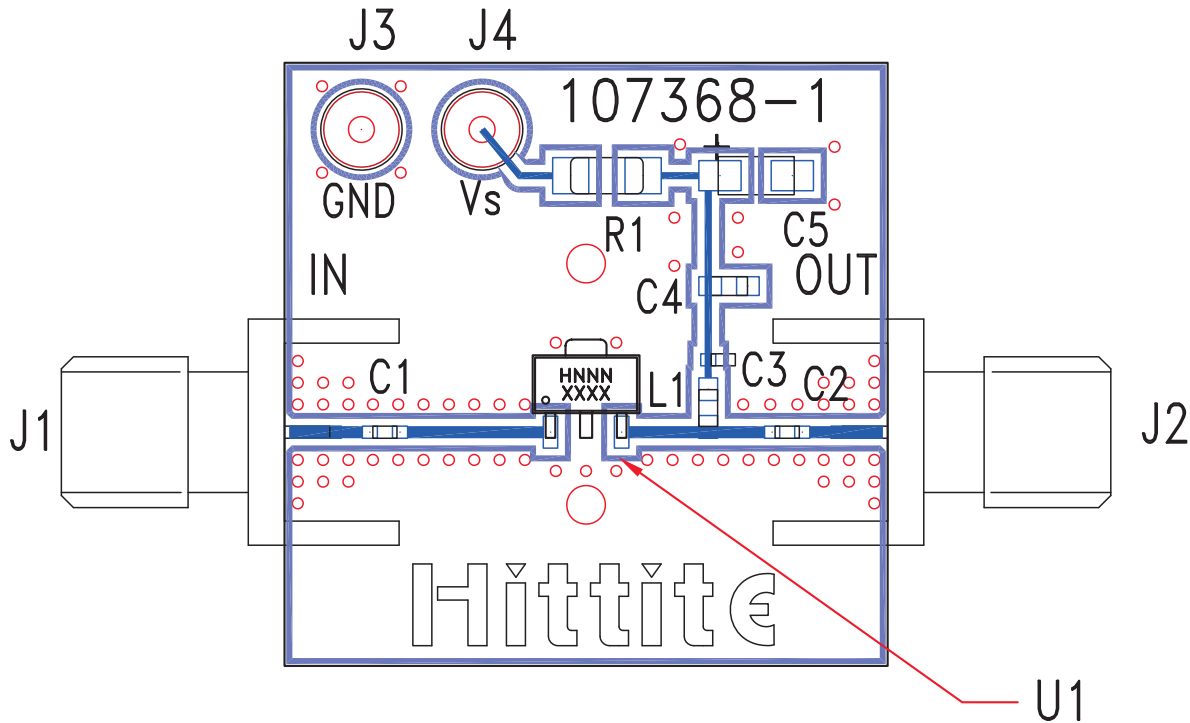

List of Materials for Evaluation PCB 116402 [1]

Item	Description
J1 - J2	PCB Mount SMA Connector
J3 - J4	DC Pin
C1, C2	Capacitor, 0402 Pkg.
C3	100 pF Capacitor, 0402 Pkg.
C4	1000 pF Capacitor, 0603 Pkg.
C5	2.2 μ F Capacitor, Tantalum
R1	Resistor, 1206 Pkg.
L1	Inductor, 0603 Pkg.
U1	HMC580ST89 / HMC580ST89E
PCB [2]	107368 Evaluation PCB

[1] Reference this number when ordering complete evaluation PCB

[2] Circuit Board Material: Rogers 4350

[3] Evaluation board tuned for 900 MHz operation

The circuit board used in the final application should use RF circuit design techniques. Signal lines should have 50 Ohm impedance while the package ground leads and package bottom should be connected directly to the ground plane similar to that shown. A sufficient number of via holes should be used to connect the top and bottom ground planes. The evaluation board should be mounted to an appropriate heat sink. The evaluation circuit board shown is available from Hittite upon request.