

R600 Relay modules DIN 3

Relay : 1NO or 1NC level contact 10 mA upto 6 A - 6 mm .236" or 12 mm .472" spacing

Characteristics

Relay characteristics	RB...111A					RB...111AI	RB...111AR	RB...101AR
	24 VAC/DC 50 / 60 Hz 0,24 W 10 mA 4,5 V	48 VAC/DC 50 / 60 Hz 0,34 W 7 mA 8 V	60 VAC/DC 50 / 60 Hz 0,54 W 9 mA 8 V	115 VAC/DC 50 / 60 Hz 0,46 W 4 mA 17 V	±10% on AC +10% -15% on DC 230 VAC/DC 50 / 60 Hz 0,8 W 3,5 mA 27 V	24 VAC/DC 50 / 60 Hz 0,24 W 10 mA 4,5 V	24 VAC/DC 50 / 60 Hz 0,24 W 10 mA 4,5 V	24 VAC/DC 50 / 60 Hz 0,24 W 10 mA 4,5 V
COIL	green LED							
Rated voltage +20%, -15% on DC ; +10%, -10% on AC								
Frequency								
Power								
Rated current								
Drop-out voltage at 20°C								
Status device								
CONTACT	1 NO							
Type	12 V / 250 V AC							
Voltage switching range min./max.	10 mA / 6 A							
Current switching range min./max.								
Load switching range	0,6 VA / 1500 VA (ohmic load)							
AC1 min. / max.	0,6 W / 140 W							
DC1 min. / max.	10 ⁵ on AC15							
Number of on-load operations	10 ⁷							
Number of off-load operations								
Operating speed	F	5 ms	5 ms	5 ms	6 ms	7 ms	5 ms	5 ms
	O	8 ms	8 ms	8 ms	15 ms	15 ms	8 ms	8 ms
Bounce	1,2 ms							
Insulation coil / contact	4000 V RMS							
Resistance to shock coil / contact	4000 V RMS							
Insulation contact / contact	1000 V RMS							
Ambient temperature storage	-40°C to +80°C							
operating	-20°C to +70°C (1)							

Other characteristics

	Screw clamp	Spring clamp
Body material	grey ■	UL 94 V0
Wire	Solid wire	UL 94 V0
size	0,2 - 4 mm ² / 24 - 12 AWG	0,2 - 2,5 mm ² / 24 - 12 AWG
Stranded wire	0,22 - 2,5 mm ² / 24 - 12 AWG	0,22 - 2,5 mm ² / 24 - 12 AWG
Rated wire size	2,5 mm ² / 12 AWG	2,5 mm ² / 12 AWG
Wire stripping length	9 mm .354"	9 mm .354"
Recommended screwdriver	3,5 mm .137"	3,5 mm .137"
Protection	IP20 NEMA1	IP20 NEMA1
Recommended torque	0,4 - 0,6 Nm 3.5 - 5.3 lb.in	0,4 - 0,6 Nm 3.5 - 5.3 lb.in

Approvals

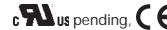

Reference standards

CEI 947-7-1 / CEI 947-1 / CEI 1131-2 (in relevant parts) / CEI 60664-1 / CEM : IRC 1000-4-2, 3, 4, 5, 6.

(1) Over 55°C, blocks have to be mounted on horizontal rail with 10 mm spacing between each block. For vertical rail mounting use temperature is 15°C less decreased.

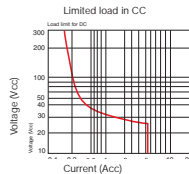

	DC12	AC12	DC13	AC15
24 V	6 A	6 A	1 A	3 A
110/120 V	0,3 A	6 A	0,2 A	3 A
220/230 V	0,2 A	6 A	0,1 A	3 A

Order codes

Description	Type	Order P/N	Packaging	Weight
			kg	kg
Screw clamp relay module 6 mm spacing	RB 111 A-24VAC/DC	1SNA 645 014 R2700	10	0,02
Screw clamp relay module 6 mm spacing	RB 111 A-48-60VAC/DC	1SNA 645 015 R2000	10	0,02
Screw clamp relay module 6 mm spacing	RB 111 A-115VAC/DC	1SNA 645 016 R2100	10	0,02
Screw clamp relay module 6 mm spacing	RB 111 A-230VAC/DC	1SNA 645 017 R2200	10	0,02
Screw cl. relay mod. with safety switch 6 mm sp.	RB 111 AI-24VAC/DC	1SNA 645 063 R0000	10	0,02
Screw cl. relay mod. w/contact protection 12 mm sp.	RB 111 AR-24VAC/DC	1SNA 645 018 R0300	5	0,03
Screw cl. relay mod. w/contact protection 12 mm sp.	RB 101 AR-24VAC/DC	1SNA 645 019 R0400	5	0,03
Spring clamp relay module 6 mm spacing	RBR 111 A-24VAC/DC	1SNA 645 514 R2100	10	0,02
Spring clamp relay module 6 mm spacing	RBR 111 A-48-60VAC/DC	1SNA 645 515 R2200	10	0,02
Spring clamp relay module 6 mm spacing	RBR 111 A-115VAC/DC	1SNA 645 516 R2300	10	0,02
Spring clamp relay module 6 mm spacing	RBR 111 A-230VAC/DC	1SNA 645 517 R2400	10	0,02
Spring cl. relay mod. with safety switch 6 mm sp.	RBR 111 AI-24VAC/DC	1SNA 645 563 R0200	10	0,02
Spring cl. relay mod. w/contact protection 12 mm sp.	RBR 111 AR-24VAC/DC	1SNA 645 518 R0500	5	0,03
Spring cl. relay mod. w/contact protection 12 mm sp.	RBR 101 AR-24VAC/DC	1SNA 645 519 R0600	5	0,03

Accessories

End section	BADH V0	1SNA 116 900 R2700	50
	BADL V0	1SNA 399 903 R0200	50
	BAM2 V0	1SNA 399 967 R0100	50
Separator end section	SC 612	1SNA 290 474 R0200	10
Divisible shunt 10 poles	BJ 612-10	1SNA 290 488 R0100	10
Divisible shunt 70 poles	BJ 612-70	1SNA 290 489 R0200	10
Screw clamp distribution block sp. 12 mm	D4/12-3A-3A	1SNA 645 031 R2000	5
Spring clamp distribution block sp. 12 mm	D4/12-3L-3L	1SNA 645 531 R2200	5
Test plug DIA. 2 mm	FC2	1SNA 007 865 R2600	10
Marking method	RC65 RC610	see marking	

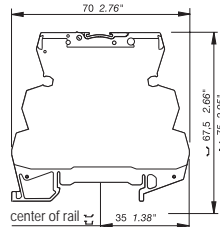

Screw clamp module

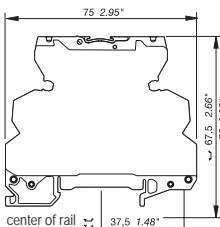

Spring clamp module

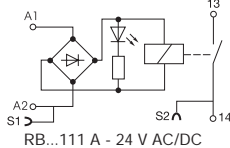

RB...111 A - 24 V AC/DC

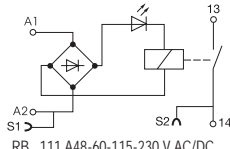

RB...111 AI

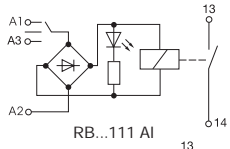

RB...111 AI

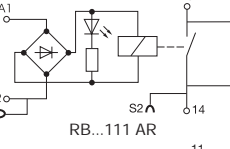

RB...111 AR

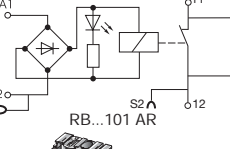

RB...101 AR

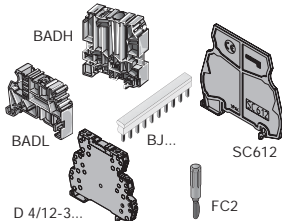

R600 Relay modules DIN 3

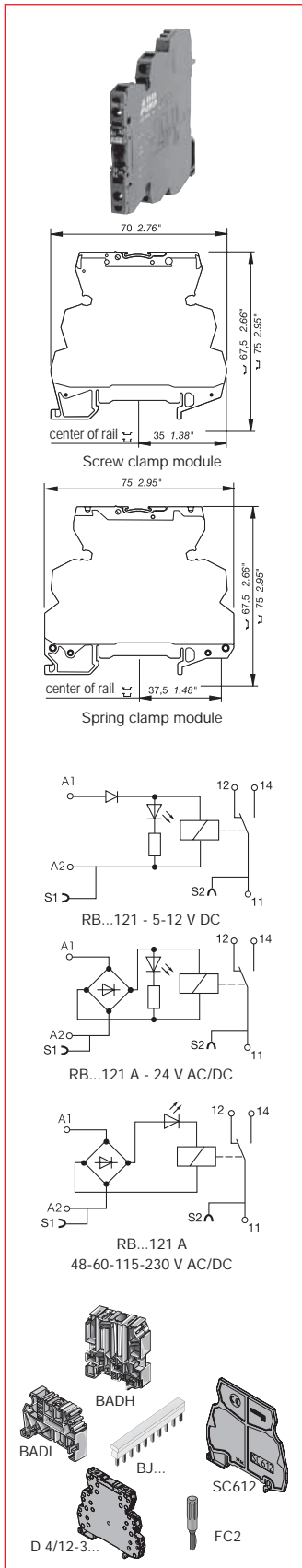

Relay : 1 SPDT level contact 10 mA upto 6 A - 6 mm .236" spacing

Characteristics

Relay characteristics	RB...121				RB...121A			
	COIL	green LED						
Rated voltage +20%, -15% on DC ; +10%, -10% on AC	5 V DC	12 V DC	24 VAC/DC	48 V AC/DC	60 V AC/DC	115 V AC/DC	±10% on AC +10% -15% on DC	
Frequency			50 / 60 Hz	50 / 60 Hz	50 / 60 Hz	50 / 60 Hz	50 / 60 Hz	
Power	0,2 W	0,2 W	0,24 W	0,33 W	0,54 W	0,46 W	0,8 W	
Rated current	40 mA	16 mA	10 mA	7 mA	9 mA	4 mA	3,5 mA	
Drop-out voltage at 20°C	1,2 V	2,2 V	4,5 V	8 V	8 V	17 V	27 V	
Status device								
CONTACT	1 SPDT							
Type	12 V / 250 V AC							
Voltage switching range min./max.	10 mA / 6 A							
Current switching range min./max.	0,6 VA / 1500 VA (ohmic load)							
Load switching range	0,6 W / 140 W							
AC1 min. / max.	10 ⁵ on AC15							
DC1 min. / max.	10 ⁷							
Number of on-load operations								
Number of off-load operations								
Operating speed	F 5 ms	5 ms	5 ms	5 ms	5 ms	6 ms	7 ms	
	O 8 ms	8 ms	8 ms	8 ms	8 ms	15 ms	16 ms	
Bounce	1,2 ms							
Insulation coil / contact	4000 V RMS							
Resistance to shock coil / contact	4000 V RMS							
Insulation contact / contact	1000 V RMS							
Ambient temperature storage	-40°C to +80°C							
operating	-20°C to +70°C (1)							
Other characteristics	Screw clamp UL 94 V0				Spring clamp UL 94 V0			
Body material	grey ■				grey ■			
Wire size	0,2 - 4 mm ² / 24 - 12 AWG				0,2 - 2,5 mm ² / 24 - 12 AWG			
Stranded wire	0,22 - 2,5 mm ² / 24 - 12 AWG				0,22 - 2,5 mm ² / 24 - 12 AWG			
Rated wire size	2,5 mm ² / 12 AWG				2,5 mm ² / 12 AWG			
Wire stripping length	9 mm .354"				9 mm .354"			
Recommended screwdriver	3,5 mm .137"				3,5 mm .137"			
Protection	IP20 NEMA1				IP20 NEMA1			
Recommended torque	0,4 - 0,6 Nm 3,5 - 5,3 lb.in				0,4 - 0,6 Nm 3,5 - 5,3 lb.in			
Approvals	pending. CE							
Reference standards	CEI 947-7-1 / CEI 947-1 / CEI 1131-2 (in relevant parts) / CEI 60664-1 / CEM : IRC 1000-4-2, 3, 4, 5, 6.							

(1) Over 55°C, blocks have to be mounted on horizontal rail with 10 mm spacing between each block. For vertical rail mounting use temperature is 15°C less decreased.

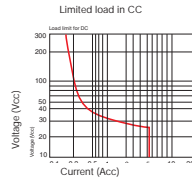

	DC12	AC12	DC13	AC15
24 V	6 A	6 A	1 A	3 A
110/120 V	0,3 A	6 A	0,2 A	3 A
220/230 V	0,2 A	6 A	0,1 A	3 A

Order codes

Description	Type	Order P/N	Packaging	Weight kg
Screw clamp relay module	RB 121-5VDC	1SNA 645 034 R2300	10	0,02
Screw clamp relay module	RB 121-12VDC	1SNA 645 035 R2400	10	0,02
Screw clamp relay module	RB 121 A-24VAC/DC	1SNA 645 001 R0300	10	0,02
Screw clamp relay module	RB 121 A-48-60VAC/DC	1SNA 645 002 R0400	10	0,02
Screw clamp relay module	RB 121 A-115VAC/DC	1SNA 645 003 R0500	10	0,02
Screw clamp relay module	RB 121 A-230VAC/DC	1SNA 645 004 R0400	10	0,02
Spring clamp relay module	RBR 121-5VDC	1SNA 645 534 R2500	10	0,02
Spring clamp relay module	RBR 121-12VDC	1SNA 645 535 R2600	10	0,02
Spring clamp relay module	RBR 121 A-24VAC/DC	1SNA 645 501 R0500	10	0,02
Spring clamp relay module	RBR 121 A-48-60VAC/DC	1SNA 645 502 R0600	10	0,02
Spring clamp relay module	RBR 121 A-115VAC/DC	1SNA 645 503 R0700	10	0,02
Spring clamp relay module	RBR 121 A-230VAC/DC	1SNA 645 504 R0000	10	0,02

Accessories

End section	BADH V0	1SNA 116 900 R2700	50
	BADL V0	1SNA 399 903 R0200	50
	BAM2 V0	1SNA 399 967 R0100	50
Separator end section	SC 612	1SNA 290 474 R0200	10
Divisible shunt 10 poles	BJ 612-10	1SNA 290 488 R0100	10
Divisible shunt 70 poles	BJ 612-70	1SNA 290 489 R0200	10
Screw clamp distribution block sp. 12 mm	D4/12-3A-3A	1SNA 645 031 R2000	5
Spring clamp distribution block sp. 12 mm	D4/12-3L-3L	1SNA 645 531 R2200	5
Test plug DIA. 2 mm	FC2	1SNA 007 865 R2600	10
Marking method	RC65 RC610	see marking	

R600 Relay modules DIN 3

Relay : 1SPDT Low level contact 1 mA upto 6 A - 6 mm .236" spacing

Characteristics

Relay characteristics	RB...121				RB...121A			
	5 V DC	12 V DC	24 VAC/DC	48 V AC/DC	60 V AC/DC	115 V AC/DC	230 V AC/DC	±10% on AC +10% -15% on DC
COIL								
Rated voltage +20%, -15% on DC ; +10%, -10% on AC								
Frequency			50 / 60 Hz	50 / 60 Hz	50 / 60 Hz	50 / 60 Hz	50 / 60 Hz	
Power	0,2 W	0,2 W	0,24 W	0,33 W	0,54 W	0,46 W	0,8 W	
Rated current	40 mA	16 mA	10 mA	7 mA	9 mA	4 mA	3,5 mA	
Drop-out voltage at 20°C	1,2 V	2,2 V	4,5 V	8 V	8 V	17 V	27 V	
Status device	green LED							
CONTACT								
Type	1 SPDT							
Voltage switching range min./max.	5 V / 250 V AC							
Current switching range min./max.	1 mA / 6 A							
Load switching range	0,05 VA / 1500 VA (ohmic load)							
AC1 min. / max.	0,05 W / 140 W							
DC1 min. / max.	10 ⁵ on AC15							
Number of on-load operations	10 ⁷							
Number of off-load operations								
Operating speed	F 5 ms	5 ms	5 ms	5 ms	5 ms	6 ms	7 ms	
	O 8 ms	8 ms	8 ms	8 ms	8 ms	15 ms	16 ms	
Bounce	1,2 ms							
Insulation coil / contact	4000 V RMS							
Resistance to shock coil / contact	4000 V RMS							
Insulation contact / contact	1000 V RMS							
Ambient temperature storage	-40°C to +80°C							
operating	-20°C to +70°C (1)							
Other characteristics	Screw clamp				Spring clamp			
Body material	grey				UL 94 V0			
Wire	Solid wire				UL 94 V0			
size	0,2 - 4 mm ² / 24 - 12 AWG				0,2 - 2,5 mm ² / 24 - 12 AWG			
Stranded wire	0,22 - 2,5 mm ² / 24 - 12 AWG				0,22 - 2,5 mm ² / 24 - 12 AWG			
Rated wire size	2,5 mm ² / 12 AWG				2,5 mm ² / 12 AWG			
Wire stripping length	9 mm .354"				9 mm .354"			
Recommended screwdriver	3,5 mm .137"				3,5 mm .137"			
Protection	IP20 NEMA1				IP20 NEMA1			
Recommended torque	0,4 - 0,6 Nm 3,5 - 5,3 lb.in				0,4 - 0,6 Nm 3,5 - 5,3 lb.in			
Approvals	cULus pending, CE							
Reference standards	CEI 947-7-1 / CEI 947-1 / CEI 1131-2 (in relevant parts) / CEI 60664-1 / CEM : IRC 1000-4-2, 3, 4, 5, 6.							

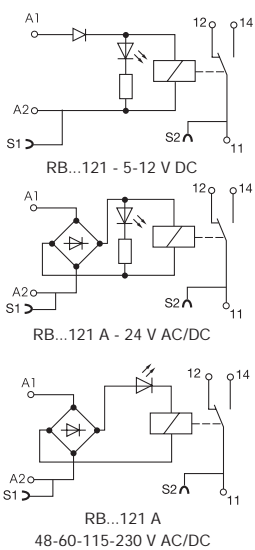
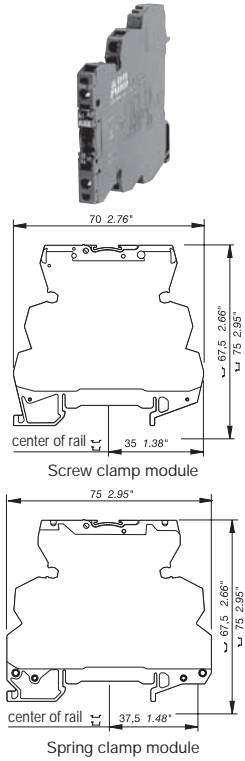

(1) Over 55°C, blocks have to be mounted on horizontal rail with 10 mm spacing between each block. For vertical rail mounting use temperature is 15°C less decreased.

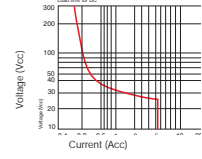

Order codes

Description	Type	Order P/N	Packaging Weight kg
Screw clamp relay module low level contact	RB 121-5VDC	1SNA 645 036 R2500	10 0,02
Screw clamp relay module low level contact	RB 121-12VDC	1SNA 645 037 R2600	10 0,02
Screw clamp relay module low level contact	RB 121 A-24VAC/DC	1SNA 645 005 R0700	10 0,02
Screw clamp relay module low level contact	RB 121 A-48-60VAC/DC	1SNA 645 006 R0000	10 0,02
Screw clamp relay module low level contact	RB 121 A-115VAC/DC	1SNA 645 007 R0100	10 0,02
Screw clamp relay module low level contact	RB 121 A-230VAC/DC	1SNA 645 008 R1200	10 0,02
Spring clamp relay module low level contact	RBR 121-5VDC	1SNA 645 536 R2700	10 0,02
Spring clamp relay module low level contact	RBR 121-12VDC	1SNA 645 537 R2000	10 0,02
Spring clamp relay module low level contact	RBR 121 A-24VAC/DC	1SNA 645 505 R0100	10 0,02
Spring clamp relay module low level contact	RBR 121 A-48-60VAC/DC	1SNA 645 506 R0200	10 0,02
Spring clamp relay module low level contact	RBR 121 A-115VAC/DC	1SNA 645 507 R0300	10 0,02
Spring clamp relay module low level contact	RBR 121 A-230VAC/DC	1SNA 645 508 R1400	10 0,02

Accessories

End section	BADH V0	1SNA 116 900 R2700	50
	BADL V0	1SNA 399 903 R0200	50
	BAM2 V0	1SNA 399 967 R0100	50
Separator end section	SC 612	1SNA 290 474 R0200	10
Divisible shunt 10 poles	BJ 612-10	1SNA 290 488 R0100	10
Divisible shunt 70 poles	BJ 612-70	1SNA 290 489 R0200	10
Screw clamp distribution block sp. 12 mm	D4/12-3A-3A	1SNA 645 031 R2000	5
Spring clamp distribution block sp. 12 mm	D4/12-3L-3L	1SNA 645 531 R2200	5
Test plug DIA. 2 mm	FC2	1SNA 007 865 R2600	10
Marking method	RC65 RC610	see marking	

R600 Relay modules DIN 3

Relay : 1 SPDT with switch or with Leakage current protection - 12 mm .472" spacing

Characteristics

Relay characteristics	RB...121 AR			RB...121 AI		
	COIL	COIL	COIL	COIL	COIL	COIL
Rated voltage +20%, -15% on DC ; +10%, -10% on AC	115 V AC/DC	±10% on AC +10% -15% on DC 230 V AC/DC	24 VAC/DC	24 VAC/DC	24 VAC/DC	24 VAC/DC
Frequency	50 / 60 Hz	50 / 60 Hz	50 / 60 Hz	50 / 60 Hz	50 / 60 Hz	50 / 60 Hz
Power	2 W	2,8 W	0,24 W	0,24 W	0,24 W	0,24 W
Rated current	18 mA	12 mA	10 mA	10 mA	10 mA	10 mA
Drop-out voltage at 20°C	17 V	27 V	4,5 V	4,5 V	4,5 V	4,5 V
Status device	green LED			green LED		
CONTACT						
Type	1 SPDT			1 SPDT		
Voltage switching range min./max.	12 V / 250 V			5 V / 250 V		
Current switching range min./max.	10 mA / 6 A			1 mA / 6 A		
Load switching range	AC1 min. / max. DC1 min. / max.			0,05 VA/1500 VA (ohmic load) 0,05 W / 140 W		
Number of on-load operations	10 ⁵ on AC15			10 ⁵ on AC15		
Number of off-load operations	10 ⁷			10 ⁷		
Operating speed	F 6 ms	7 ms	5 ms	5 ms	5 ms	5 ms
	O 15 ms	16 ms	8 ms	8 ms	8 ms	8 ms
Bounce				4000 V RMS		
Insulation coil / contact				4000 V RMS		
Resistance to shock coil / contact				1000 V RMS		
Insulation contact / contact				-40°C to +80°C		
Ambient temperature storage				-20°C to +70°C (1)		
Ambient temperature operating						
Other characteristics	Screw clamp UL 94 V0			Spring clamp UL 94 V0		
Body material	grey ■			grey ■		
Wire size	0,2 - 4 mm ² / 24 - 12 AWG			0,2 - 2,5 mm ² / 24 - 12 AWG		
Wire size	Stranded wire			Stranded wire		
Rated wire size	2,5 mm ² / 12 AWG			2,5 mm ² / 12 AWG		
Wire stripping length	9 mm .354"			9 mm .354"		
Recommended screwdriver	3,5 mm .137"			3,5 mm .137"		
Protection	IP20 NEMA1			IP20 NEMA1		
Recommended torque	0,4 - 0,6 Nm 3.5 - 5.3 lb.in			0,4 - 0,6 Nm 3.5 - 5.3 lb.in		
Approvals	UL pending, CE			UL pending, CE		
Reference standards	CEI 947-1-1 / CEI 947-1 / CEI 1131-2 (in relevant parts) / CEI 60664-1 / CEM : IRC 1000-4-2, 3, 4, 5, 6.					

(1) Over 55°C, blocks have to be mounted on horizontal rail with 10 mm spacing between each block. For vertical rail mounting use temperature is 15°C less decreased.

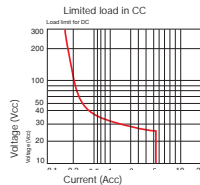

	DC12	AC12	DC13	AC15
24 V	6 A	6 A	1 A	3 A
110/120 V	0,3 A	6 A	0,2 A	3 A
220/230 V	0,2 A	6 A	0,1 A	3 A

Order codes

Description	Type	Order P/N	Packaging	Weight kg
Screw cl. relay module w/leakage current protection	RB 121 AR-115VAC/DC	1SNA 645 046 R0700	5	0,03
Screw cl. relay module w/leakage current protection	RB 121 AR-230VAC/DC	1SNA 645 011 R2400	5	0,03
Screw clamp relay module with switch	RB 121 AI-24VAC/DC	1SNA 645 032 R2100	5	0,03
Screw clamp relay module with safety switch	RB 121 AI-24VAC/DC	1SNA 645 009 R1300	5	0,03
Screw clamp relay module low level w/switch	RB 121 AI-24VAC/DC	1SNA 645 033 R2200	5	0,03
Screw clamp relay module low level w/safety switch	RB 121 AI-24VAC/DC	1SNA 645 010 R0700	5	0,03
Spring cl. relay module w/leakage current protection	RBR 121 AR-115VAC/DC	1SNA 645 546 R0100	5	0,03
Spring cl. relay module w/leakage current protection	RBR 121 AR-230VAC/DC	1SNA 645 511 R2600	5	0,03
Spring clamp relay module with switch	RBR 121 AI-24VAC/DC	1SNA 645 532 R2300	5	0,03
Spring clamp relay module with safety switch	RBR 121 AI-24VAC/DC	1SNA 645 509 R1500	5	0,03
Spring clamp relay module low level w/switch	RBR 121 AI-24VAC/DC	1SNA 645 533 R2400	5	0,03
Spring clamp relay module low level w/safety switch	RBR 121 AI-24VAC/DC	1SNA 645 510 R0100	5	0,03

Accessories

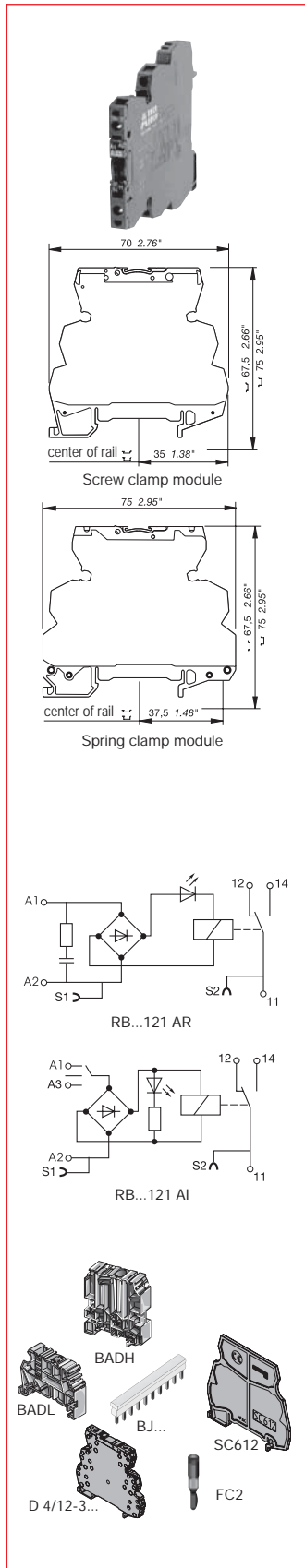

End section	BADH V0	1SNA 116 900 R2700	50
	BADL V0	1SNA 399 903 R0200	50
	BAM2 V0	1SNA 399 967 R0100	50
Separator end section	SC 612	1SNA 290 474 R0200	10
Divisible shunt 10 poles	BJ 612-10	1SNA 290 488 R0100	10
Divisible shunt 70 poles	BJ 612-70	1SNA 290 489 R0200	10
Screw clamp distribution block sp. 12 mm	D4/12-3A-3A	1SNA 645 031 R2000	5
Spring clamp distribution block sp. 12 mm	D4/12-3L-3L	1SNA 645 531 R2200	5
Test plug DIA. 2 mm	FC2	1SNA 007 865 R2600	10
Marking method	RC65 RC610	see marking	



R600 Relay modules DIN 3

Relay : 1DPDT Low level contact 1 mA upto 8 A - 12 mm .472" spacing

Characteristics

Relay characteristics	RB...122A				
	24 VAC/DC 50 / 60 Hz	48 V AC/DC 50 / 60 Hz	60 V AC/DC 50 / 60 Hz	115 V AC/DC 50 / 60 Hz	+10% on AC +10% -15% on DC 230 V AC/DC 50 / 60 Hz
COIL Rated voltage +20%, -15% on DC ; +10%, -10% on AC Frequency					
Power	0,48 W	0,62 W	0,96 W	0,58 W	1,15 W
Rated current	20 mA	13 mA	16 mA	5 mA	5 mA
Drop-out voltage at 20°C	5,4 V	8,8 V	8,8 V	20 V	10 V
Status device	green LED				
CONTACT Type	1 DPDT				
Voltage switching range min./max.	5 V / 250 V DC - 250 V AC				
Current switching range min./max.	1 mA / 8 A				
Load switching range	5 mVA / 1500 VA				
AC1 min. / max. DC1 min. / max.	5 mW / 192 W				
Number of on-load operations	10 ⁵				
Number of off-load operations	2 x 10 ⁷				
Operating speed	F 6 ms	10 ms	10 ms	6 ms	6 ms
	O 10 ms	14 ms	14 ms	15 ms	15 ms
Bounce	1 ms				
Insulation coil / contact	4000 V RMS				
Resistance to shock coil / contact	4000 V RMS				
Insulation contact / contact	3500 V RMS				
Ambient temperature storage	-40°C to +80°C				
operating	-20°C to +70°C (1)				
Other characteristics	Screw clamp UL 94 V0		Spring clamp UL 94 V0		
Body material	grey				
Wire size	Solid wire 0,2 - 4 mm ² / 24 - 12 AWG		0,2 - 2,5 mm ² / 24 - 12 AWG		
Stranded wire	0,22 - 2,5 mm ² / 24 - 12 AWG		0,22 - 2,5 mm ² / 24 - 12 AWG		
Rated wire size	2,5 mm ² / 12 AWG		2,5 mm ² / 12 AWG		
Wire stripping length	9 mm .354"		9 mm .354"		
Recommended screwdriver	3,5 mm .137"		3,5 mm .137"		
Protection	IP20 NEMA1		IP20 NEMA1		
Recommended torque	0,4 - 0,6 Nm 3.5 - 5.3 lb.in		0,4 - 0,6 Nm 3.5 - 5.3 lb.in		
Approvals	 				
Reference standards	CEI 947-7-1 / CEI 947-1 / CEI 1131-2 (in relevant parts) / CEI 60664-1 / CEM : IRC 1000-4-2, 3, 4, 5, 6.				

(1) Over 55°C, blocks have to be mounted on horizontal rail with 10 mm spacing between each block. For vertical rail mounting use temperature is 15°C less decreased.

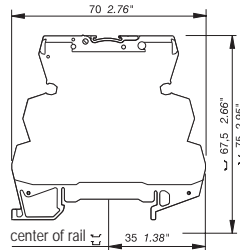

Screw clamp module

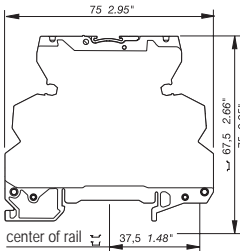

Spring clamp module

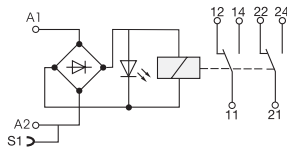

RB...122 A
24-48-60 V AC/DC

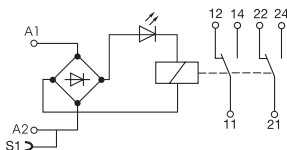

RB...122 A
115-230 V AC/DC

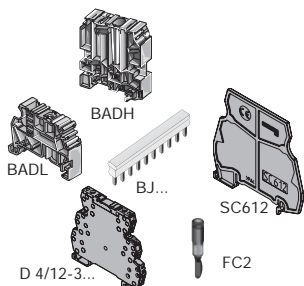

Order codes

Description	Type	Order P/N	Packaging	Weight kg
Screw clamp relay module	RB 122 A-24VAC/DC	1SNA 645 012 R2500	5	0,03
Screw clamp relay module	RB 122 A-48-60VAC/DC	1SNA 645 040 R1500	5	0,03
Screw clamp relay module	RB 122 A-115VAC/DC	1SNA 645 041 R0200	5	0,03
Screw clamp relay module	RB 122 A-230VAC/DC	1SNA 645 013 R2600	5	0,03
Spring clamp relay module	RBR 122 A-24VAC/DC	1SNA 645 512 R2700	5	0,03
Spring clamp relay module	RBR 122 A-48-60VAC/DC	1SNA 645 540 R1700	5	0,03
Spring clamp relay module	RBR 122 A-115VAC/DC	1SNA 645 541 R0400	5	0,03
Spring clamp relay module	RBR 122 A-230VAC/DC	1SNA 645 513 R2000	5	0,03

Accessories

End section	BADH V0	1SNA 116 900 R2700	50
	BADL V0	1SNA 399 903 R0200	50
	BAM2 V0	1SNA 399 967 R0100	50
Separator end section	SC 612	1SNA 290 474 R0200	10
Divisible shunt 10 poles	BJ 612-10	1SNA 290 488 R0100	10
Divisible shunt 70 poles	BJ 612-70	1SNA 290 489 R0200	10
Screw clamp distribution block sp. 12 mm	D4/12-3A-3A	1SNA 645 031 R2000	5
Spring clamp distribution block sp. 12 mm	D4/12-3L-3L	1SNA 645 531 R2200	5
Test plug DIA. 2 mm	FC2	1SNA 007 865 R2600	10
Marking method	RC65 RC610	see marking	