

1SMB5.0A
THRU
1SMB170A



**SURFACE MOUNT SILICON
UNI-DIRECTIONAL
GLASS PASSIVATED JUNCTION
TRANSIENT VOLTAGE SUPPRESSORS
600 WATT, 5.0 THRU 170 VOLT**



www.centrasemi.com

DESCRIPTION:

The CENTRAL SEMICONDUCTOR 1SMB5.0A Series types are Surface Mount Uni-Directional Glass Passivated Junction Transient Voltage Suppressors designed to protect voltage sensitive components from high voltage transients.

THIS DEVICE IS MANUFACTURED WITH A GLASS PASSIVATED CHIP FOR OPTIMUM RELIABILITY.

Note: For Bi-directional devices, please refer to the 1SMB5.0CA Series data sheet.

MARKING CODE: SEE ELECTRICAL CHARACTERISTICS TABLE

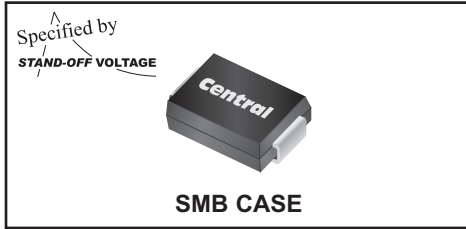

SMB CASE

MAXIMUM RATINGS: ($T_A=25^\circ\text{C}$ unless otherwise noted)

Peak Power Dissipation (Note 1)
Peak Forward Surge Current (JEDEC Method)
Operating and Storage Junction Temperature

SYMBOL

P_{DM} 600
 I_{FSM} 100
 T_J, T_{stg} -65 to +150

UNITS

W
A
 $^\circ\text{C}$

ELECTRICAL CHARACTERISTICS: ($T_A=25^\circ\text{C}$ unless otherwise noted)

TYPE	REVERSE STAND-OFF VOLTAGE	BREAKDOWN VOLTAGE		TEST CURRENT	MAXIMUM REVERSE LEAKAGE CURRENT @ V_{RWM}	MAXIMUM CLAMPING VOLTAGE @ I_{pp}	PEAK PULSE CURRENT (Note 1)	MARKING CODE
		V_{BR} @ I_T						
	V_{RWM} (V)	MIN (V)	MAX (V)	I_T (mA)	I_R (μA)	V_C (V)	I_{pp} (A)	
1SMB5.0A	5.0	6.40	7.25	10	800	9.2	65.2	CKE
1SMB6.0A	6.0	6.67	7.67	10	800	10.3	58.3	CKG
1SMB6.5A	6.5	7.22	8.30	10	500	11.2	53.6	CKK
1SMB7.0A	7.0	7.78	8.95	10	200	12	50	CKM
1SMB7.5A	7.5	8.33	9.58	1.0	100	12.9	46.5	CKP
1SMB8.0A	8.0	8.89	10.23	1.0	50	13.6	44.1	CKR
1SMB8.5A	8.5	9.44	10.82	1.0	10	14.4	41.7	CKT
1SMB9.0A	9.0	10	11.5	1.0	5.0	15.4	39	CKV
1SMB10A	10	11.1	12.8	1.0	5.0	17	35.3	CKX
1SMB11A	11	12.2	14	1.0	5.0	18.2	33	CKZ
1SMB12A	12	13.3	15.3	1.0	5.0	19.9	30.2	CLE
1SMB13A	13	14.4	16.5	1.0	5.0	21.5	27.9	CLG
1SMB14A	14	15.6	17.9	1.0	5.0	23.2	25.8	CLK
1SMB15A	15	16.7	19.2	1.0	5.0	24.4	24	CLM
1SMB16A	16	17.8	20.5	1.0	5.0	26	23.1	CLP
1SMB17A	17	18.9	21.7	1.0	5.0	27.6	21.7	CLR
1SMB18A	18	20	23.3	1.0	5.0	29.2	20.5	CLT
1SMB20A	20	22.2	25.5	1.0	5.0	32.4	18.5	CLV
1SMB22A	22	24.4	28	1.0	5.0	35.5	16.9	CLX
1SMB24A	24	26.7	30.7	1.0	5.0	38.9	15.4	CLZ
1SMB26A	26	28.9	33.2	1.0	5.0	42.1	14.2	CME
1SMB28A	28	31.1	35.8	1.0	5.0	45.4	13.2	CMG
1SMB30A	30	33.3	38.3	1.0	5.0	48.4	12.4	CMK

Notes: (1) Non-repetitive 10x1,000 μs pulse.

R5 (22-August 2016)

**1SMB5.0A
THRU
1SMB170A**

**SURFACE MOUNT SILICON
UNI-DIRECTIONAL
GLASS PASSIVATED JUNCTION
TRANSIENT VOLTAGE SUPPRESSORS
600 WATT, 5.0 THRU 170 VOLT**



ELECTRICAL CHARACTERISTICS - Continued:

TYPE	REVERSE STAND-OFF VOLTAGE	BREAKDOWN VOLTAGE		TEST CURRENT	MAXIMUM REVERSE LEAKAGE CURRENT @ V_{RWM}	MAXIMUM CLAMPING VOLTAGE @ I_{PP}	PEAK PULSE CURRENT (Note 1)	MARKING CODE
		V_{BR} @ I_T						
	V_{RWM} (V)	MIN (V)	MAX (V)	I_T (mA)	I_R (μ A)	V_C (V)	I_{PP} (A)	
1SMB33A	33	36.7	42.2	1.0	5.0	53.3	11.3	CMM
1SMB36A	36	40	46	1.0	5.0	58.1	10.3	CMP
1SMB40A	40	44.4	51.1	1.0	5.0	64.5	9.3	CMR
1SMB43A	43	47.8	54.9	1.0	5.0	69.4	8.6	CMT
1SMB45A	45	50	57.5	1.0	5.0	72.7	8.3	CMV
1SMB48A	48	53.3	61.3	1.0	5.0	77.4	7.7	CMX
1SMB51A	51	56.7	65.2	1.0	5.0	82.4	7.3	CMZ
1SMB54A	54	60	69	1.0	5.0	87.1	6.9	CNE
1SMB58A	58	64.4	74.1	1.0	5.0	93.6	6.4	CNG
1SMB60A	60	66.7	76.7	1.0	5.0	96.8	6.2	CNK
1SMB64A	64	71.1	81.8	1.0	5.0	103	5.8	CNM
1SMB70A	70	77.8	89.5	1.0	5.0	113	5.3	CNP
1SMB75A	75	83.3	95.8	1.0	5.0	121	4.9	CNR
1SMB78A	78	86.7	99.7	1.0	5.0	126	4.7	CNT
1SMB85A	85	94.4	108.2	1.0	5.0	137	4.4	CNV
1SMB90A	90	100	115.5	1.0	5.0	146	4.1	CNX
1SMB100A	100	111	128	1.0	5.0	162	3.7	CNZ
1SMB110A	110	122	140.5	1.0	5.0	177	3.4	CPE
1SMB120A	120	133	153	1.0	5.0	193	3.1	CPG
1SMB130A	130	144	165.5	1.0	5.0	209	2.9	CPK
1SMB150A	150	167	192.5	1.0	5.0	243	2.5	CPM
1SMB160A	160	178	205	1.0	5.0	259	2.3	CPP
1SMB170A	170	189	217.5	1.0	5.0	275	2.2	CPR

SMB CASE - MECHANICAL OUTLINE

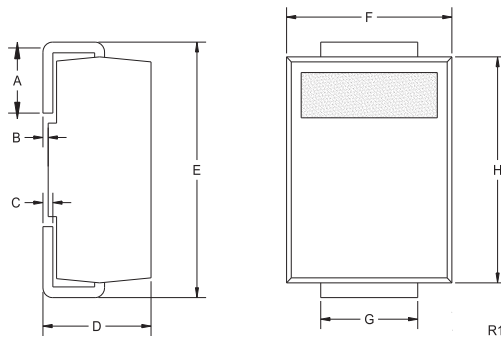

DIMENSIONS				
SYMBOL	INCHES		MILLIMETERS	
	MIN	MAX	MIN	MAX
A	0.030	0.060	0.76	1.52
B	0.004	0.008	0.10	0.20
C	0.006	0.012	0.15	0.30
D	0.086	0.096	2.18	2.44
E	0.200	0.220	5.08	5.59
F	0.130	0.150	3.30	3.81
G	0.077	0.083	1.96	2.11
H	0.160	0.180	4.06	4.57

SMB (REV: R1)

R5 (22-August 2016)

1SMB5.0A
THRU
1SMB170A



SURFACE MOUNT SILICON
UNI-DIRECTIONAL
GLASS PASSIVATED JUNCTION
TRANSIENT VOLTAGE SUPPRESSORS
600 WATT, 5.0 THRU 170 VOLT



TYPICAL ELECTRICAL CHARACTERISTICS

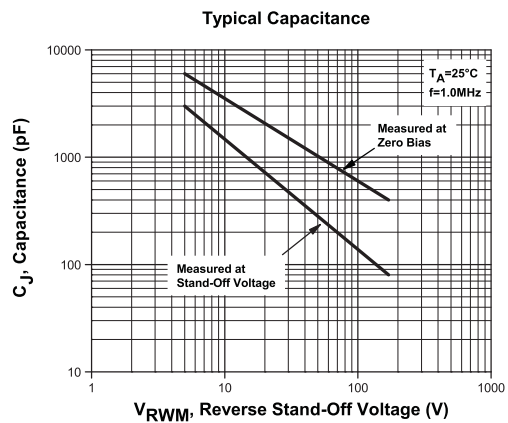
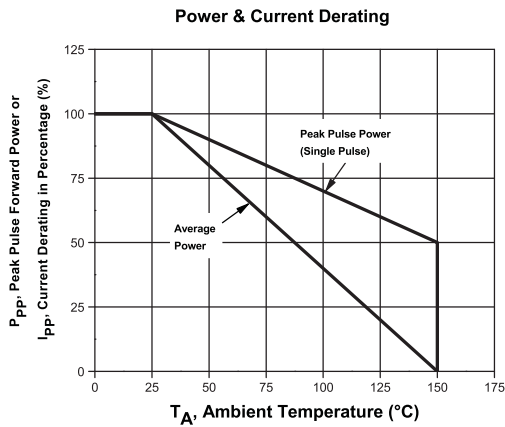
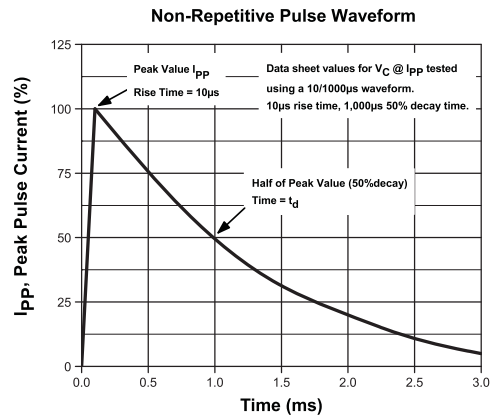
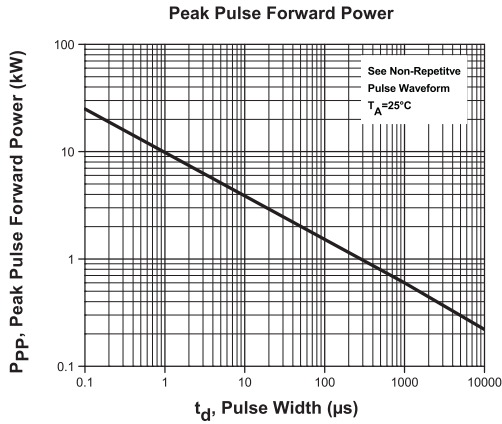

R5 (22-August 2016)

OUTSTANDING SUPPORT AND SUPERIOR SERVICES



PRODUCT SUPPORT

Central's operations team provides the highest level of support to insure product is delivered on-time.

- Supply management (Customer portals)
- Inventory bonding
- Consolidated shipping options
- Custom bar coding for shipments
- Custom product packing

DESIGNER SUPPORT/SERVICES

Central's applications engineering team is ready to discuss your design challenges. Just ask.

- Free quick ship samples (2nd day air)
- Online technical data and parametric search
- SPICE models
- Custom electrical curves
- Environmental regulation compliance
- Customer specific screening
- Up-screening capabilities
- Special wafer diffusions
- PbSn plating options
- Package details
- Application notes
- Application and design sample kits
- Custom product and package development

CONTACT US

Corporate Headquarters & Customer Support Team

Central Semiconductor Corp.
145 Adams Avenue
Hauppauge, NY 11788 USA
Main Tel: (631) 435-1110
Main Fax: (631) 435-1824
Support Team Fax: (631) 435-3388
www.centalsemi.com

Worldwide Field Representatives:
www.centalsemi.com/wwreps

Worldwide Distributors:
www.centalsemi.com/wwdistributors

For the latest version of Central Semiconductor's **LIMITATIONS AND DAMAGES DISCLAIMER**, which is part of Central's Standard Terms and Conditions of sale, visit: www.centalsemi.com/terms

Mouser Electronics

Authorized Distributor

Click to View Pricing, Inventory, Delivery & Lifecycle Information:

Central Semiconductor:

[1SMB10A TR13](#) [1SMB12A TR13](#) [1SMB13A TR13](#) [1SMB130A TR13](#) [1SMB14A TR13](#) [1SMB15A TR13](#) [1SMB150A TR13](#) [1SMB16A TR13](#) [1SMB160A TR13](#) [1SMB170A TR13](#) [1SMB18A TR13](#) [1SMB20A TR13](#) [1SMB22A TR13](#) [1SMB24A TR13](#) [1SMB26A TR13](#) [1SMB28A TR13](#) [1SMB33A TR13](#) [1SMB36A TR13](#) [1SMB45A TR13](#) [1SMB48A TR13](#) [1SMB5.0A TR13](#) [1SMB51A TR13](#) [1SMB58A TR13](#) [1SMB6.0A TR13](#) [1SMB6.5A TR13](#) [1SMB60A TR13](#) [1SMB64A TR13](#) [1SMB7.0A TR13](#) [1SMB7.5A TR13](#) [1SMB70A TR13](#) [1SMB78A TR13](#) [1SMB8.0A TR13](#) [1SMB8.5A TR13](#) [1SMB85A TR13](#) [1SMB9.0A TR13](#) [1SMB90A TR13](#) [1SMB20CA TR13](#) [1SMB15CA TR13](#) [1SMB10CA TR13](#) [1SMB5.0CA TR13](#) [1SMB170CA TR13](#) [1SMB15CA BK](#) [1SMB5.0A BK](#) [1SMB7.5A BK](#) [1SMB12A BK](#) [1SMB160A BK](#)