

# DFK-PC 16/ 3-STF-SH-10,16

Order No.: 1703629

The figure shows a 5-pos. version of the product

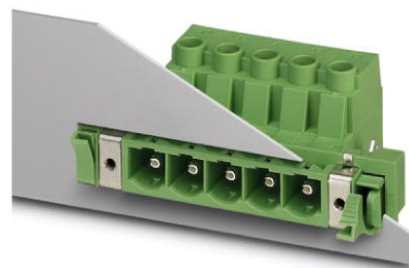

<http://eshop.phoenixcontact.de/phoenix/treeViewClick.do?UID=1703629>

Plug component, Nominal current: 76 A, Rated voltage (III/2): 1000 V, Number of positions: 3, Pitch: 10.16 mm, Connection method: Screw connection, Color: Green

Commercial data	
GTIN (EAN)	 4 017918 994464
Note	Made-to-order
sales group	E543
Pack	10 pcs.
Customs tariff	85366990
Catalog page information	Page 489 (CC-2011)

#### Product notes

WEEE/RoHS-compliant since:  
11/27/2004



<http://www.download.phoenixcontact.com>  
Please note that the data given here has been taken from the online catalog. For comprehensive information and data, please refer to the user documentation. The General Terms and Conditions of Use apply to Internet downloads.

Technical data	
<b>Dimensions / positions</b>	
Pitch	10.16 mm
Dimension a	20.32 mm
Number of positions	3
Screw thread	M4

Tightening torque, min	1.7 Nm
Tightening torque max	1.8 Nm

**Technical data**

Range of articles	DFK-PC 16/...STF-SH
Insulating material group	I
Rated surge voltage (III/3)	8 kV
Rated surge voltage (III/2)	8 kV
Rated surge voltage (II/2)	6 kV
Rated voltage (III/2)	1000 V
Rated voltage (II/2)	1000 V
Connection in acc. with standard	EN-VDE
Nominal current $I_N$	76 A
Nominal voltage $U_N$	1000 V
Nominal cross section	1.6 mm <sup>2</sup>
Maximum load current	76 A
Insulating material	PA
Inflammability class acc. to UL 94	V0
Internal cylindrical gage	A6
Stripping length	14 mm
Nominal voltage, UL/CUL Use Group B	600 V
Nominal current, UL/CUL Use Group B	55 A
Nominal voltage, UL/CUL Use Group C	600 V
Nominal current, UL/CUL Use Group C	55 A

**Connection data**

Conductor cross section solid min.	0.75 mm <sup>2</sup>
Conductor cross section solid max.	16 mm <sup>2</sup>
Conductor cross section stranded min.	0.75 mm <sup>2</sup>
Conductor cross section stranded max.	16 mm <sup>2</sup>
Conductor cross section stranded, with ferrule without plastic sleeve min.	0.5 mm <sup>2</sup>
Conductor cross section stranded, with ferrule without plastic sleeve max.	16 mm <sup>2</sup> Only in connection with CRIMPFOX 16 S
Conductor cross section stranded, with ferrule with plastic sleeve min.	0.5 mm <sup>2</sup>
Conductor cross section stranded, with ferrule with plastic sleeve max.	16 mm <sup>2</sup> Only in connection with CRIMPFOX 16 S

Conductor cross section AWG/kcmil min.	18
Conductor cross section AWG/kcmil max	6
2 conductors with same cross section, solid min.	0.75 mm <sup>2</sup>
2 conductors with same cross section, solid max.	6 mm <sup>2</sup>
2 conductors with same cross section, stranded min.	0.75 mm <sup>2</sup>
2 conductors with same cross section, stranded max.	6 mm <sup>2</sup>
2 conductors with same cross section, stranded, ferrules without plastic sleeve, min.	0.5 mm <sup>2</sup>
2 conductors with same cross section, stranded, ferrules without plastic sleeve, max.	4 mm <sup>2</sup>
2 conductors with same cross section, stranded, TWIN ferrules with plastic sleeve, min.	0.5 mm <sup>2</sup>
2 conductors with same cross section, stranded, TWIN ferrules with plastic sleeve, max.	6 mm <sup>2</sup>
Minimum AWG according to UL/CUL	20
Maximum AWG according to UL/CUL	6

**Certificates / Approvals**



Certification

CB, CCA, CUL, SEV, UL

**Diagrams/Drawings**

Drilling plan/solder pad geometry

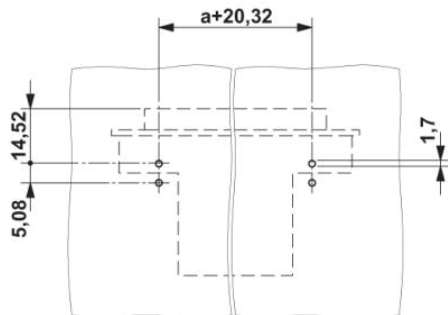

Diagram

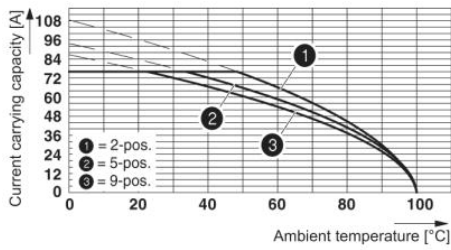

Derating curve for: PC 16/...-ST-10.16 with DFK-PC 16/...-ST-10.16

Dimensioned drawing

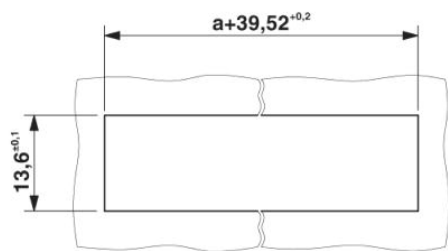

Sheet metal cutout for snap-on.

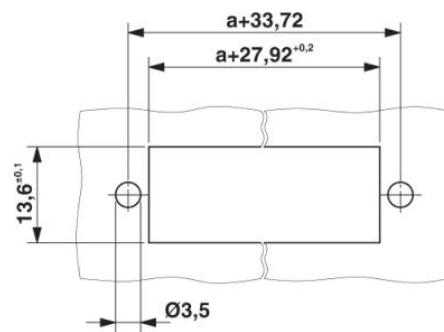

Sheet metal cutout for screw connection.

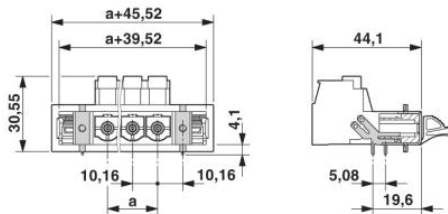

**Address**

PHOENIX CONTACT Inc., USA  
586 Fulling Mill Road  
Middletown, PA 17057, USA  
Phone (800) 888-7388  
Fax (717) 944-1625  
<http://www.phoenixcon.com>



© 2011 Phoenix Contact  
Technical modifications reserved;