

THIS DRAWING IS UNPUBLISHED. RELEASED FOR PUBLICATION 20
 © COPYRIGHT 20 ALL RIGHTS RESERVED.

LOC		DIST		REVISIONS			
P	LTR	DESCRIPTION	DATE	DWN	APVD		
FT	0	AI	REVISED PER ECO-11-007905	15APR2011	HMR	CR	

TEST FACILITY

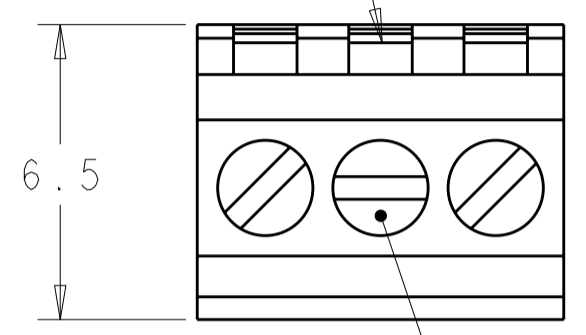

CLAMPING SCREW

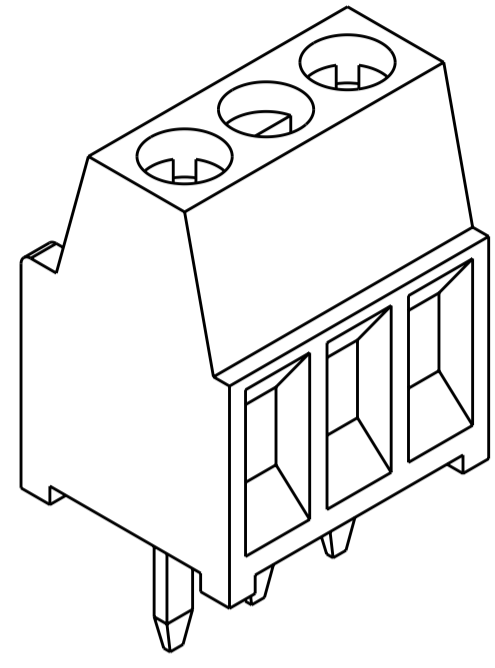

1546215-3 AS SHOWN

- ⚠ MATERIAL AND FINISH:
 HOUSING: PA 6-6, UL 94-V0, COLOR: GRAY.
 CLAMP: BRASS, NICKEL PLATED.
 TERMINAL: BRASS, TIN PLATED.
 CLAMPING SCREW: M1.6, STAINLESS STEEL.
- SUITABLE FOR 1,6-2,4mm PCB BOARD THICKNESS.
 - WIRE RANGE: 16-30 AWG.
 - RECOGNIZED UNDER THE COMPONENT PROGRAM OF UNDERWRITERS LABORATORIES INC. FILE N° E60677.
 - POSSIBILITY TO PUT TWO OR THREE TERMINAL BLOCKS SIDE BY SIDE BY INCREASING THE DIAMETER OF THE PCB HOLES TO MINIMUM 1,3mm.
 - TORQUE: 1.73 in-lbs MAX

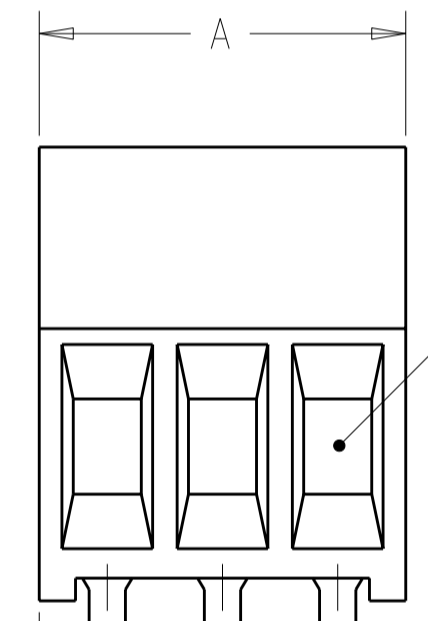

WIRE ENTRY

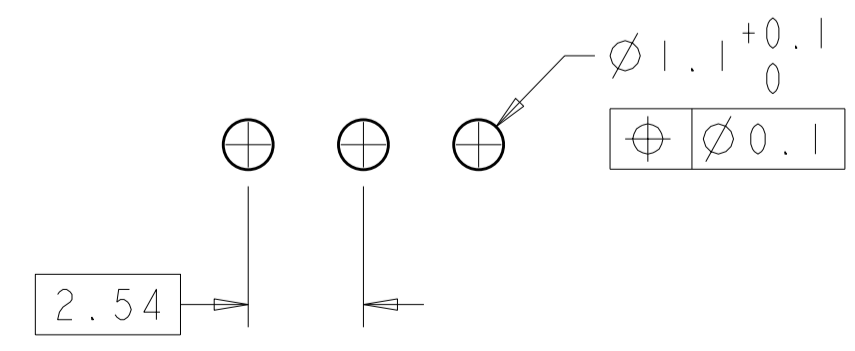
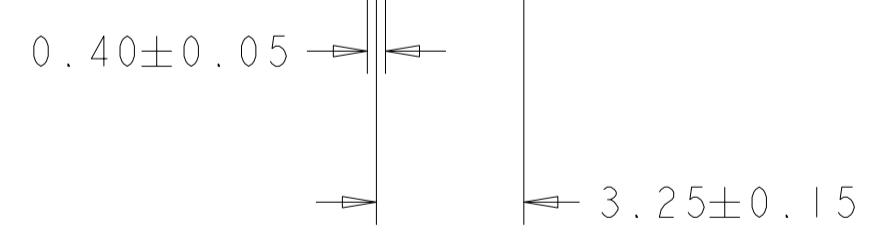
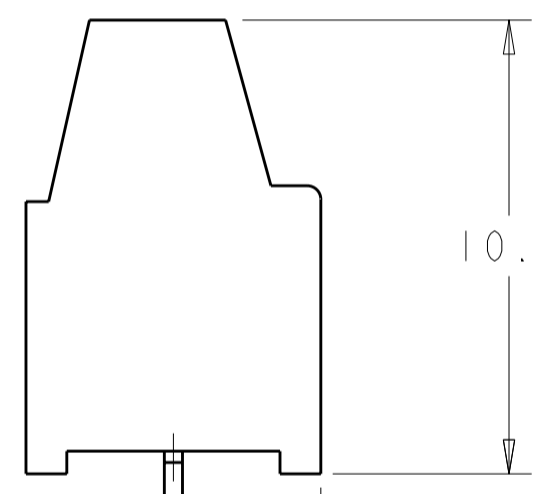
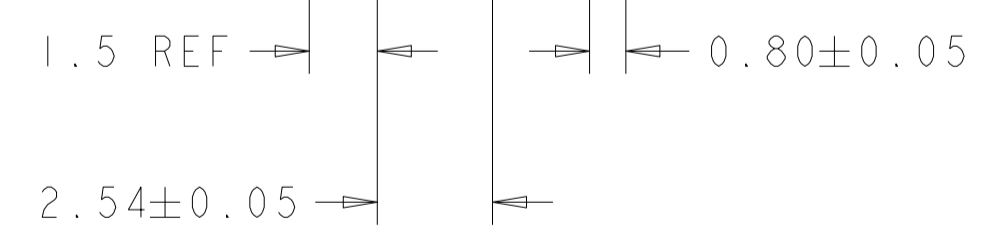

RECOMMENDED PC BOARD LAYOUT

30.94	12	1-1546215-2
28.40	11	1-1546215-1
25.86	10	1-1546215-0
23.32	9	1546215-9
20.78	8	1546215-8
18.24	7	1546215-7
15.70	6	1546215-6
13.16	5	1546215-5
10.62	4	1546215-4
8.08	3	1546215-3
5.54	2	1546215-2
A	NO OF POSN	PART NUMBER

THIS DRAWING IS A CONTROLLED DOCUMENT.

DWN: S. WELDON 09MAR2004
 CHK: C. RICHARD 09MAR2004
 APVD: C. RICHARD 09MAR2004

STE TE Connectivity

NAME: TERMINAL BLOCK ASSEMBLY, PCB MOUNT, SIDE WIRE ENTRY, STACKING, 2.54mm PITCH

PRODUCT SPEC: 108-20166
 APPLICATION SPEC: 114-20079

SIZE: A2 CAGE CODE: 00779 DRAWING NO: 1546215 RESTRICTED TO: -

MATERIAL: - FINISH: - WEIGHT: -

CUSTOMER DRAWING SCALE: 5:1 SHEET: 1 OF 1 REV: AI

Mouser Electronics

Authorized Distributor

Click to View Pricing, Inventory, Delivery & Lifecycle Information:

[TE Connectivity:](#)

[1-1546215-0](#)