

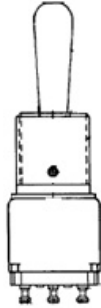

11TW1-1



Actual product appearance may vary.

TW Series Toggle Switch, 1 pole, 3 position, Solder terminal, Standard Lever, Military Part Number MS27718-21-1

Features



- Qualified to MIL-S-83731
- Save space and weight
- SPDT and DPDT circuitry
- Temperature range: -85°F to +160°F (-65°C to +71°C)
- Sealed bushing versions
- Choice of 1/8 in. or 15/32 in. bushing
- Color tab available on 15/32 in. bushing
- UL recognized

Potential Applications

- Industrial machinery and equipment
- Military and commercial aviation
- Construction equipment
- Test instruments
- Agricultural machinery
- Process control
- Medical instrumentation

Description

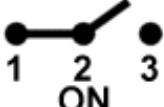
MICRO SWITCH™ miniature toggle switches in two bushing sizes. Molded-in terminals are plated for soldering. Momentary and maintained circuitry closures available. Special on-on-on circuitries are also available. Pull-to-unlock levers prevent accidental operation.

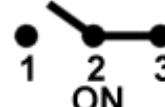
Product Specifications			
Circuitry/ Operating action	Keyway Position 	Center Position 	Opposite Keyway Position 
Product Type	MICRO SWITCH™ Toggle Switch		

Ampere/ Voltage Range (Resistive Load)	0.1 A to 5.0 A at 0.5 Vdc to 28 Vdc,0.1 A to 5.0 A at 0.5 Vac to 115 Vac
Circuitry	SPDT
Action	3 position
Mounting	Bushing 15/32 in
Termination	Solder
Military Part Number	MS27718-21-1
Lever Type	Standard
UL/CSA Rating Code	L117: 5 A at 125 Vac
Comment	Fine silver contacts
Availability	Global
UNSPSC Code	30211908
UNSPSC Commodity	30211908 Toggle switches
Series Name	TW

11TW1 SERIES
 CHART 1
 M
 DRAWING NUMBER
 11921
 ISSUE

REVISIONS
 A 00 45 47
 B 00 00 00
 C 00 00 00
 D 00 00 00
 E 00 00 00
 F 00 00 00
 G 00 00 00
 H 00 00 00
 I 00 00 00
 J 00 00 00
 K 00 00 00
 L 00 00 00
 M 00 00 00
 N 00 00 00
 O 00 00 00
 P 00 00 00
 Q 00 00 00
 R 00 00 00
 S 00 00 00
 T 00 00 00
 U 00 00 00
 V 00 00 00
 W 00 00 00
 X 00 00 00
 Y 00 00 00
 Z 00 00 00

SCALE 2:1
 DO NOT SCALE PRINT
 UNLESS OTHERWISE NOTED
 DIMENSIONS ARE IN INCHES
 TOLERANCES ARE
 ONE PLACE (.05)
 TWO PLACE (.005)
 THREE PLACE (.0005)
 ANGLES
 WEIGHT .025 LB MAX

MICRO SWITCH
 THE HONEYWELL DIVISION OF HONEYWELL
 FED. WFG. CODE 91929

SWITCH-TOGGLE

CATALOG LISTING
11TW1 SERIES
CHART 1

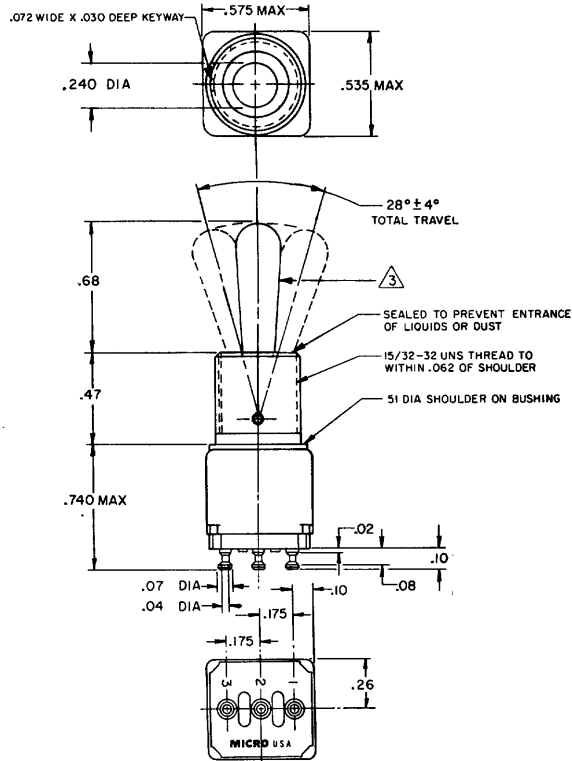

MILITARY PART NUMBER	CATALOG LISTING	CIRCUIT MADE WITH TOGGLE LEVER IN		
		KEYWAY SIDE (1-2)	CENTER (1-2)	OPPOSITE KEYWAY (2-3)
MS 27718-21-1	11TW1-1	ON	OFF	ON
MS 27718-22-1	11TW1-2	OFF	NONE	ON
MS 27718-23-1	11TW1-3	ON	NONE	ON
	11TW1-21	NONE	OFF	ON
	11TW1-31	NONE	ON	ON
	11TW1-4	MOM OFF	NONE	ON
MS 27718-31-1	11TW1-5	MOM ON	OFF	ON
	11TW1-6	MOM ON	NONE	OFF
MS 27718-27-1	11TW1-7	MOM ON	OFF	MOM ON
MS 27718-26-1	11TW1-8	MOM ON	NONE	ON
	11TW1-41	NONE	MOM OFF	ON
	11TW1-51	NONE	ON	MOM ON
	11TW1-61	MOM ON	OFF	NONE

ELECTRICAL DATA

CODE L117 5A-125 VAC

CODE L117 5A-125 VAC

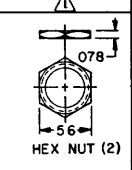
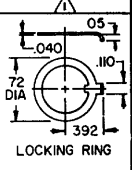
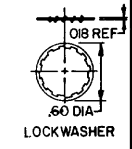

NOTES
 1 - FURNISHED UNASSEMBLED
 2 - TERMINALS ARE PLATED FOR SOLDERING
 3 - MATTE FINISH