

THIS DRAWING IS UNPUBLISHED. RELEASED FOR PUBLICATION 30/09/2005.
 EQUIPMENT 2003 BY TYCO ELECTRONICS CORPORATION. ALL RIGHTS RESERVED.

LOC	DIST	REVISIONS				
		P	LNK	DATE	BY	APP
E	B	D		08/03/05	AM	FWK
		DESCRIPTION				
		EBD0-0108-05				

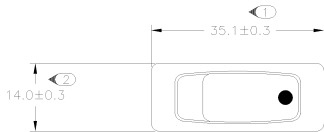

PANEL CUT OUT

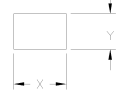

2.00-3.00	30.20	11.20
1.25-2.00	30.20	11.20
0.75-1.25	30.20	11.20
PANEL THICKNESS	X	Y

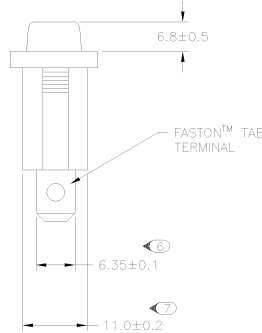
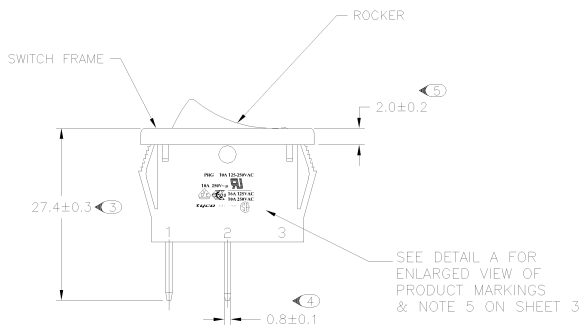

CIRCUIT DIAGRAM



PRODUCT MARKING
DETAIL A

PRG 10A 125VAC

10A 250V~μ **16A 125VAC**
10A 250VAC



1634202-2 SHOWN ON-OFF

DIMENSIONS:		TOLERANCES UNLESS OTHERWISE SPECIFIED:		MATERIAL:		FINISH:		REVISIONS:	
MM		0.150	0.250	1.0	2.0	3.0	4.0	5.0	6.0
APPROVALS:		DESIGNER:		DRAWN:		CHECKED:		DATE:	
S. SHACKLSON 04FEB2003		S. SHACKLSON 04FEB2003		H. KAVITZ 04FEB2003		H. KAVITZ 04FEB2003		08/03/05	
NAME:		PRODUCT SPEC:		APPLICATION SPEC:		PROJECT:		SCALE:	
POWER ROCKER SWITCH, 30.2mm X 11.2mm		NOT APPLICABLE		NOT APPLICABLE		-		3:1	
PANEL CUT-OUT SIZE, SINGLE POLE, SINGLE THROW, NON-ILLUMINATED		-		-		-		SHEET 1 OF 3	
CUSTOMER DRAWING		-		-		-		REV D	
DRAWN BY:		DRAWN DATE:		DRAWN BY:		DRAWN DATE:		DRAWN BY:	
-		-		-		-		-	
-		-		-		-		-	
-		-		-		-		-	

THIS DRAWING IS UNPUBLISHED. RELEASED FOR PUBLICATION 30/04/2003.
 © 2003 BY TYCO ELECTRONICS CORPORATION. ALL RIGHTS RESERVED.

LOC	DIST	REVISIONS					
E	B	P	LTR	DESCRIPTION	DATE	BY	APP'D
		-		SEE SHEET 1			

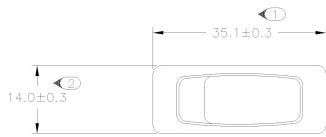

PANEL CUT OUT

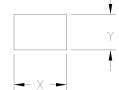

2.00-3.00	30.20	11.20
1.25-2.00	30.20	11.20
0.75-1.25	30.20	11.20
PANEL THICKNESS	X	Y

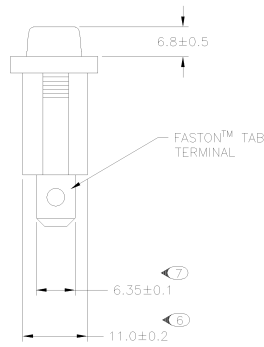
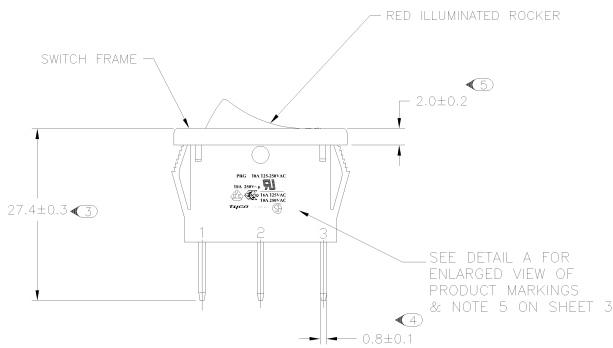

CIRCUIT DIAGRAM

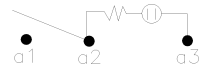

PRODUCT MARKING
DETAIL A

PRG 10A 125-250VAC

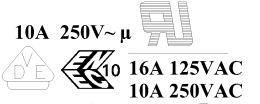

tyco Electronics



1634202-5 SHOWN ON-OFF
(ILLUMINATED)

THIS DRAWING IS A CONTROLLED DOCUMENT		DWG: S. SHACKLSON 04FEB2003		tyco Electronics		Tyco Electronics Corporation Harrisburg, PA 17057	
DIMENSIONS: MW		DR: H. KAUTZ 04FEB2003		NAME: H. KAUTZ		POWER ROCKER SWITCH, 30.2mm X 11.2mm	
TOLERANCES UNLESS OTHERWISE SPECIFIED:		PRODUCT SPEC: NOT APPLICABLE		APPLICATION SPEC: NOT APPLICABLE		PANEL CUT-OUT SIZE, SINGLE POLE, SINGLE THROW, ILLUMINATED	
MATERIAL:		FINISH:		RECKIT: -		RESTRICTED TO: -	
CUSTOMER DRAWING		SCALE: 3:1		SHEET: 2 OF 3		REV: D	

4

3

2

1

THIS DRAWING IS UNPUBLISHED. RELEASED FOR PUBLICATION 30/09/2003.
 © COPYRIGHT 2003 BY TYCO ELECTRONICS CORPORATION. ALL RIGHTS RESERVED.

LOC	DIST	REVISIONS					
E	B	P	CHK	DESCRIPTION	DATE	BY	APP'D
-	-	-	-	SEE SHEET 1	-	-	-

ALCOSWITCH PART NUMBER



SWITCH TYPE: X1X2 = PR - POWER ROCKER
 NOMINAL PANEL CUT OUT SIZE: X3 = G - 30.2X11.2 [1.189x.441]
 NUMBER OF POLES: X4 = S - SINGLE
 SWITCH FUNCTION: X5X6 = A1 - BI -

SECONDARY ROCKER COLOR: X12 = Ø - NOT APPLICABLE
B - BLACK
G - GREEN
R - RED
W - WHITE

LEGEND TEXT PATTERN: X13 =

CURRENT RATING: X7X8 = 16 -

TERMINAL TYPE: X9 = F - FASTON™ TAB

FRAME COLOR: X10 = B - BLACK
W - WHITE

ROCKER COLOR: X11 = B - BLACK
G - GREEN
R - RED
Y - YELLOW

LEGEND TEXT COLOR: X14 = Ø - NOT APPLICABLE
G - GREEN
R - RED
B - BLACK
W - WHITE

MATERIALS:
 HOUSING FRAME: NYLON 66.
 ACTUATOR: NYLON 66/ PC(ILLUMINATED)
 TERMINALS C1100R-1/2H WITH SILVER PLATED CONTACTS
 AgALLOY

FINISH:
 TERMINAL, ACTIVE CONTACTOR: 1.0µm [.000039] SILVER
 PLUNGER: 3.0µm [.000118] NICKEL

3. ELECTRICAL SPECIFICATIONS:
 CONTACT RESISTANCE : 50m ohm Max
 DIELECTRIC STRENGTH : AC 1500V, 1 MINUTE
 OPERATION TEMPERATURE: -20°C~85°C
 INSULATION R: DC 500V 100M ohm MIN

CURRENT AND VOLTAGE 10A@125VAC/10A@250VAC

5. ELECTRICAL RATINGS, APPROVED AGENCY LOGOS, TYCO ELECTRONICS LOGO AND PART NUMBER CAN APPEAR ON EITHER SIDE. (FOR FULL DETAIL SEE INDIVIDUAL DRAWING)

ON-OFF, WITH OPAQUE, SINGLE-COLOR ROCKER BUTTON.

ON-OFF, WITH TRANSPARENT, LAMP-ILLUMINATED ROCKER BUTTON.

8. REFER TO QIP DIMENSIONAL REPORT

2	PRGSB1-16F-BG000	1634202-6
2	PRGSB1-16F-BR000	1634202-5
1	PRGSA 1-16F-BR000	1634202-4
1	PRGSA 1-16F-BB0BW	1634202-3
1	PRGSA 1-16F-BB0AW	1634202-2
1	PRGSA 1-16F-BB000	1634202-1
SHEET REF	ALCOSWITCH PART NUM BER.	TYCO PART NUMBER.

THIS DRAWING IS A CONTROLLED DOCUMENT		DRW: S SHACKSON 28JAN2003	Tyco Electronics Corporation Harrisburg, PA 17057
DIMENSIONS: MM		DR: H KAUTZ 28JAN2003	
TO DIMENSIONS UNLESS OTHERWISE SPECIFIED: 0 P.L.C. # - # - # 1 P.L.C. # 0.35(012) 2 P.L.C. # 0.50(002) 3 P.L.C. # - # - # 4 P.L.C. # - # - # ANGLES # - # - # FINISH # - # - #		APP: E KAUTZ 28JAN2003	NAME: POWER ROCKER SWITCH, 30.2mm X 22.2mm
MATERIAL: FINISH:		PRODUCT SPEC: NOT APPLICABLE	SIZE: CASE CODE: DRAWING NO: RESTRICTED TO: -
		APPLICATION SPEC: NOT APPLICABLE	SCALE: 3:1 SHEET 3 OF 3 REV D
		REWORK: -	CUSTOMER DRAWING