



Bridgelux® Gen. 7 Décor Series™

Product Data Sheet DS94



BXRC-27H1000	27H2000	27H4000	30H1000	30H2000	30H4000
BXRC-17E4000	25E4000	56G4000	17E10K0	25E10K0	56G10K0

Introduction

Vero

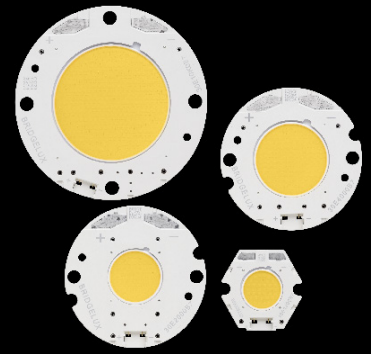

The Bridgelux Décor Series™ line of products produce unmatched quality of light with brilliant color rendering options designed specifically for high end, niche applications. The Bridgelux Décor line of specialty LED products is available on the Bridgelux Vero Series of chip on board products.

Décor Series™ Ultra products provide a high CRI of 97, befitting of the most luxurious retail shops and world renowned museums.

Décor Series™ Food products offer color points developed to address the unique requirements of the food, grocery, and restaurant industries. Highlighting the distinctive colors and nuanced patterns found in meats and breads, the Décor Food products are a must have for any butcher counter or bakery.

Décor Series™ Specialty products provide color points developed specifically for the healthcare and entertainment industries. The 5600K color point combined with a CRI of 90 provides the bright white required by these industries.

The Vero platform represents a revolutionary advancement in chip on board (COB) light source technology and innovation. Vero simplifies luminaire design and manufacturing processes, improves light quality, and defines a platform for future functionality integration.

The Vero Series products are available in four different LES (light emitting surface) configurations and have been engineered to reliably operate over a broad current range, enabling new degrees of flexibility in luminaire design optimization. These industry leading arrays deliver increased lumen density to enable improved beam control and precision lighting with 2 and 3 SDCM color control standard for clean and consistent uniform lighting. Vero also includes an on board connector port to enable solder free electrical interconnect and simple easy to use mounting features to enable plug-and-play installation.

Features

- Typical 97 CRI with a 95 CRI minimum (Décor Series Ultra)
- Application specific color points
- Typical R9 value of 98 for brilliant rendering of red colors and skin tones (Décor Series Ultra)
- 2 and 3 SDCM color control
- Reliable operation at up to 2X nominal drive current
- Radial die pattern and improved lumen density
- Thermally isolated solder pads
- Onboard connector port
- Top side part number markings

Benefits

- Broad application coverage for interior lighting requiring state of the art color rendering
- Flexibility for application driven lighting design requirements
- High quality true color reproduction
- Uniform consistent white light
- Flexibility in design optimization
- Improved optical control
- Enhanced ease of use and manufacturability
- Solder-less connectivity enables plug & play installation and field upgradability
- Improved inventory management and quality control



Contents

Product Feature Map	2
Product Nomenclature	2
Product Selection Guide	3
Performance at Commonly Used Drive Currents	5
Electrical Characteristics	10
Absolute Maximum Ratings	11
Performance Curves	12
Typical Radiation Pattern	19
Typical Color Spectrum	20
Mechanical Dimensions	21
Color Binning Information	25
Packaging and Labeling	26
Design Resources	29
Precautions	29
Disclaimers	29
About Bridgelux	30

Product Feature Map

In addition to delivering the performance and light quality required for many lighting applications, Décor Series LED arrays incorporate several features to

simplify the design integration and manufacturing process, accelerate time to market and reduce system costs.

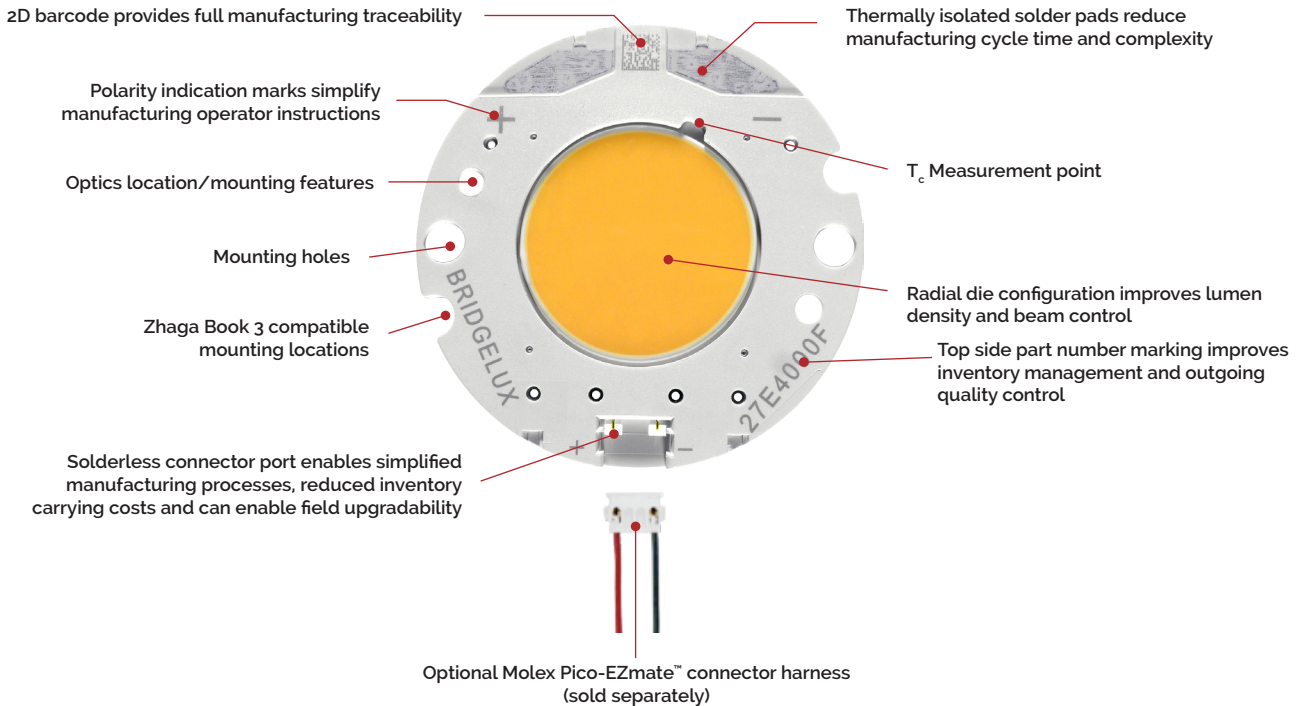

Product Nomenclature

The part number designation for Bridgelux Vero Décor Series LED arrays is explained as follows:

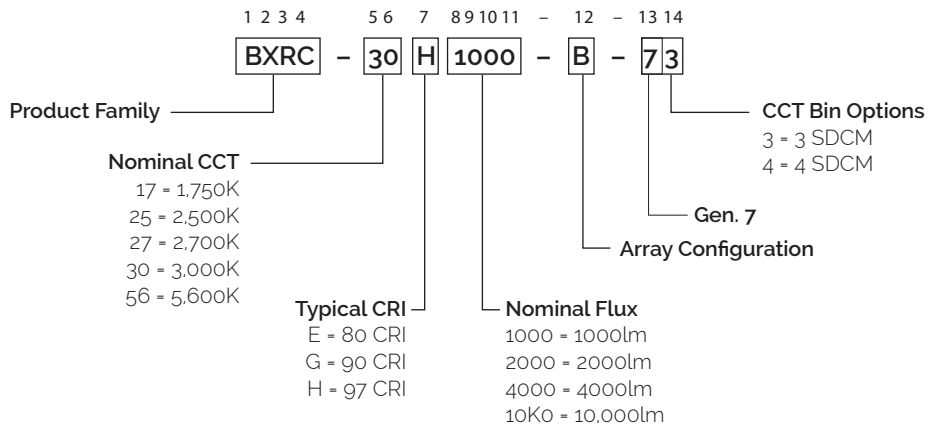

Product Selection Guide

The following product configurations are available:

Table 1: Selection Guide, Pulsed Measurement Data ($T_j = T_c = 25^\circ\text{C}$)

Product	Part Number	Nominal CCT ¹ (K)	CRI ²	Nominal Drive Current ³ (mA)	Typical Pulsed Flux ^{4,5,6} $T_c = 25^\circ\text{C}$ (lm)	Minimum Pulsed Flux ^{6,7} $T_c = 25^\circ\text{C}$ (lm)	Typical V_f (V)	Typical Power (W)	Typical Efficacy (lm/W)
Décor Ultra Vero 10B	BXRC-27H1000-B-73	2700	97	270	1058	934	35.0	9.5	112
Décor Ultra Vero 10C	BXRC-27H1000-C-73	2700	97	360	1410	1241	35.0	12.6	112
Décor Ultra Vero 10D	BXRC-27H1000-D-73	2700	97	350	1028	957	26.0	9.1	113
Décor Ultra Vero 10B	BXRC-30H1000-B-73	3000	97	270	1133	1000	35.0	9.5	120
Décor Ultra Vero 10C	BXRC-30H1000-C-73	3000	97	360	1510	1329	35.0	12.6	120
Décor Ultra Vero 10D	BXRC-30H1000-D-73	3000	97	350	1101	1024	26.0	9.1	121
Décor Ultra Vero 13B	BXRC-27H2000-B-73	2700	97	450	1826	1721	35.0	15.8	116
Décor Ultra Vero 13C	BXRC-27H2000-C-73	2700	97	630	2556	2352	35.0	22.1	116
Décor Ultra Vero 13D	BXRC-27H2000-D-73	2700	97	500	1860	1729	31.8	15.9	117
Décor Ultra Vero 13B	BXRC-30H2000-B-73	3000	97	450	1951	1839	35.0	15.8	124
Décor Ultra Vero 13C	BXRC-30H2000-C-73	3000	97	630	2731	2513	35.0	22.1	124
Décor Ultra Vero 13D	BXRC-30H2000-D-73	3000	97	500	1987	1847	31.8	15.9	125
Décor Ultra Vero 18B	BXRC-27H4000-B-73	2700	97	900	3652	3427	35.0	31.5	116
Décor Ultra Vero 18C	BXRC-27H4000-C-73	2700	97	1170	4748	4368	35.0	41.0	116
Décor Ultra Vero 18D	BXRC-27H4000-D-73	2700	97	1050	3550	3355	29.0	30.5	117
Décor Ultra Vero 18B	BXRC-30H4000-B-73	3000	97	900	3901	3661	35.0	31.5	124
Décor Ultra Vero 18C	BXRC-30H4000-C-73	3000	97	1170	5073	4667	35.0	41.0	124
Décor Ultra Vero 18D	BXRC-30H4000-D-73	3000	97	1050	3793	3585	29.0	30.5	125
Décor Food Vero 18B	BXRC-17E4000-B-74	1750	80	900	2684	2519	35.0	31.5	85
Décor Food Vero 18C	BXRC-17E4000-C-74	1750	80	1170	3490	3211	35.0	41.0	85
Décor Food Vero 18D	BXRC-17E4000-D-74	1750	80	1050	2610	2466	29.0	30.5	86
Décor Food Vero 18B	BXRC-25E4000-B-74	2500	80	900	4338	4071	35.0	31.5	138
Décor Food Vero 18C	BXRC-25E4000-C-74	2500	80	1170	5641	5189	35.0	41.0	138
Décor Food Vero 18D	BXRC-25E4000-D-74	2500	80	1050	4218	3986	29.0	30.5	139
Décor Specialty Vero 18B	BXRC-56G4001-B-74	5600	90	900	4619	4335	35.0	31.5	147
Décor Specialty Vero 18C	BXRC-56G4001-C-74	5600	90	1170	6006	5525	35.0	41.0	147
Décor Specialty Vero 18D	BXRC-56G4001-D-74	5600	90	1050	4491	4244	29.0	30.5	147
Décor Food Vero 29B	BXRC-17E10K0-B-74	1750	80	1800	8053	7409	52.0	93.6	86
Décor Food Vero 29C	BXRC-17E10K0-C-74	1750	80	1710	10200	9384	69.4	118.7	86
Décor Food Vero 29D	BXRC-17E10K0-D-74	1750	80	2100	6785	6242	37.6	79.0	86
Décor Food Vero 29B	BXRC-25E10K0-B-74	2500	80	1800	13016	11975	52.0	93.6	139
Décor Food Vero 29C	BXRC-25E10K0-C-74	2500	80	1710	16487	15168	69.4	118.7	139
Décor Food Vero 29D	BXRC-25E10K0-D-74	2500	80	2100	10967	10089	37.6	79.0	139
Décor Specialty Vero 29B	BXRC-56G10K1-B-74	5600	90	1800	13859	12750	52.0	93.6	148
Décor Specialty Vero 29C	BXRC-56G10K1-C-74	5600	90	1710	17554	16150	69.4	118.7	148
Décor Specialty Vero 29D	BXRC-56G10K1-D-74	5600	90	2100	11677	10742	37.6	79.0	148

Notes for Table 1:

- Nominal CCT as defined by ANSI C78.377-2011. Products with CCTs 5000K-6500K are hot targeted to 85°C.
- Minimum CRI for 97 CRI products is 95 CRI, all other CRI values are minimums. Minimum R_g value for 80 CRI products is 0, the minimum R_g values for 90 CRI products is 50.
- Drive current is referred to as nominal drive current.
- Products tested under pulsed condition (10ms pulse width) at nominal test current where T_j (junction temperature) = T_c (case temperature) = 25°C.
- Typical performance values are provided as a reference only and are not a guarantee of performance.
- Bridgelux maintains a ± 7% tolerance on flux measurements.
- Minimum flux values at the nominal test current are guaranteed by 100% test.

Product Selection Guide

The following product configurations are available:

Table 2: Selection Guide, Stabilized DC Performance ($T_c = 85^\circ\text{C}$)^{4,5}

Product	Part Number	Nominal CCT ¹ (K)	CRI ²	Nominal Drive Current ³ (mA)	Typical DC Flux $T_c = 85^\circ\text{C}$ (lm)	Minimum DC Flux ⁶ $T_c = 85^\circ\text{C}$ (lm)	Typical V_f (V)	Typical Power (W)	Typical Efficacy (lm/W)
Décor Ultra Vero 10B	BXRC-27H1000-B-73	2700	97	270	952	841	34.0	9.2	104
Décor Ultra Vero 10C	BXRC-27H1000-C-73	2700	97	360	1269	1117	34.0	12.3	104
Décor Ultra Vero 10D	BXRC-27H1000-D-73	2700	97	350	925	861	25.3	8.9	105
Décor Ultra Vero 10B	BXRC-30H1000-B-73	3000	97	270	1020	900	34.0	9.2	111
Décor Ultra Vero 10C	BXRC-30H1000-C-73	3000	97	360	1359	1196	34.0	12.3	111
Décor Ultra Vero 10D	BXRC-30H1000-D-73	3000	97	350	991	922	25.3	8.9	112
Décor Ultra Vero 13B	BXRC-27H2000-B-73	2700	97	450	1643	1549	34.1	15.3	107
Décor Ultra Vero 13C	BXRC-27H2000-C-73	2700	97	630	2300	3664	34.1	21.5	107
Décor Ultra Vero 13D	BXRC-27H2000-D-73	2700	97	500	1674	4670	30.9	15.5	108
Décor Ultra Vero 13B	BXRC-30H2000-B-73	3000	97	450	1756	1655	34.1	15.3	114
Décor Ultra Vero 13C	BXRC-30H2000-C-73	3000	97	630	2458	2262	34.1	21.5	114
Décor Ultra Vero 13D	BXRC-30H2000-D-73	3000	97	500	1788	1662	30.9	15.5	116
Décor Ultra Vero 18B	BXRC-27H4000-B-73	2700	97	900	3287	3084	34.1	30.7	107
Décor Ultra Vero 18C	BXRC-27H4000-C-73	2700	97	1170	4273	3931	34.3	40.1	107
Décor Ultra Vero 18D	BXRC-27H4000-D-73	2700	97	1050	3195	3020	28.1	29.5	108
Décor Ultra Vero 18B	BXRC-30H4000-B-73	3000	97	900	3511	3295	34.1	30.7	114
Décor Ultra Vero 18C	BXRC-30H4000-C-73	3000	97	1170	4566	4200	34.3	40.1	114
Décor Ultra Vero 18D	BXRC-30H4000-D-73	3000	97	1050	3414	3227	28.1	29.5	116
Décor Food Vero 18B	BXRC-17E4000-B-74	1750	80	900	2416	2267	34.1	30.7	79
Décor Food Vero 18C	BXRC-17E4000-C-74	1750	80	1170	3141	2890	34.3	40.1	78
Décor Food Vero 18D	BXRC-17E4000-D-74	1750	80	1050	2349	2219	28.1	29.5	80
Décor Food Vero 18B	BXRC-25E4000-B-74	2500	80	900	3904	3664	34.1	30.7	127
Décor Food Vero 18C	BXRC-25E4000-C-74	2500	80	1170	5077	4670	34.3	40.1	127
Décor Food Vero 18D	BXRC-25E4000-D-74	2500	80	1050	3796	3587	28.1	29.5	129
Décor Specialty Vero 18B	BXRC-56G4001-B-74	5600	90	900	4157	3902	34.1	30.7	135
Décor Specialty Vero 18C	BXRC-56G4001-C-74	5600	90	1170	5405	4973	34.3	40.1	135
Décor Specialty Vero 18D	BXRC-56G4001-D-74	5600	90	1050	4042	3820	28.1	29.5	137
Décor Food Vero 29B	BXRC-17E10K0-B-74	1750	80	1800	7248	6668	50.7	91.2	79
Décor Food Vero 29C	BXRC-17E10K0-C-74	1750	80	1710	9180	8446	68.4	116.9	79
Décor Food Vero 29D	BXRC-17E10K0-D-74	1750	80	2100	6107	5618	36.3	76.2	80
Décor Food Vero 29B	BXRC-25E10K0-B-74	2500	80	1800	11714	10778	50.7	91.2	128
Décor Food Vero 29C	BXRC-25E10K0-C-74	2500	80	1710	14838	13651	68.4	116.9	127
Décor Food Vero 29D	BXRC-25E10K0-D-74	2500	80	2100	9870	9080	36.3	76.2	130
Décor Specialty Vero 29B	BXRC-56G10K1-B-74	5600	90	1800	12473	11475	50.7	91.2	137
Décor Specialty Vero 29C	BXRC-56G10K1-C-74	5600	90	1710	15799	14535	68.4	116.9	135
Décor Specialty Vero 29D	BXRC-56G10K1-D-74	5600	90	2100	10509	9668	36.3	76.2	138

Notes for Table 2:

- Nominal CCT as defined by ANSI C78.377-2011. Products with CCTs 5000K-6500K are hot targeted to 85°C.
- Minimum CRI for 97 CRI products is 95 CRI, all other CRI values are minimums. Minimum Rg value for 80 CRI products is 0, the minimum Rg values for 90 CRI products is 50.
- Drive current is referred to as nominal drive current.
- Typical stabilized DC performance values are provided as reference only and are not a guarantee of performance.
- Typical performance is estimated based on operation under DC (direct current) with LED array mounted onto a heat sink with thermal interface material and the case temperature maintained at 85°C. Based on Bridgelux test setup, values may vary depending on the thermal design of the luminaire and/or the exposed environment to which the product is subjected.
- Minimum flux values at elevated temperatures are provided for reference only and are not guaranteed by 100% production testing. Based on Bridgelux test setup, values may vary depending on the thermal design of the luminaire and/or the exposed environment to which the product is subjected.

Performance at Commonly Used Drive Currents

Vero LED arrays are tested to the specifications shown using the nominal drive currents in Table 1. Vero may also be driven at other drive currents dependent on specific application design requirements. The performance at any drive current can be derived from the current vs. voltage characteristics shown in Figure 1-12 and the flux vs. current characteristics shown in Figures 13-24. The performance at commonly used drive currents is summarized in Table 3.

Table 3: Product Performance at Commonly Used Drive Currents

Product	Part Number	CRI	Drive Current ¹ (mA)	Typical V_f $T_c = 25^\circ\text{C}$ (V)	Typical Power $T_c = 25^\circ\text{C}$ (W)	Typical Flux ² $T_c = 25^\circ\text{C}$ (lm)	Typical DC Flux ³ $T_c = 85^\circ\text{C}$ (lm)	Typical Efficacy $T_c = 25^\circ\text{C}$ (lm/W)
Décor Ultra Vero 10	BXRC-27H1000-B-73	97	135	33.3	4.5	564	507	126
			180	33.8	6.1	739	665	121
			270	35.0	9.5	1058	952	112
			405	36.4	14.8	1552	1397	105
			540	37.8	20.4	1989	1790	98
Décor Ultra Vero 10	BXRC-27H1000-C-73	97	180	33.3	6.0	750	675	125
			240	33.8	8.1	982	884	121
			360	35.0	12.6	1410	1269	112
			540	36.4	19.7	2053	1848	104
			720	37.7	27.1	2623	2360	97
Décor Ultra Vero 10	BXRC-27H1000-D-73	97	175	24.9	4.4	549	494	126
			233	25.4	5.9	720	648	122
			350	26.0	9.1	1028	925	113
			525	27.4	14.4	1513	1362	105
			700	28.4	19.9	1939	1745	97
Décor Ultra Vero 10	BXRC-30H1000-B-73	97	135	33.3	4.5	604	543	134
			180	33.8	6.1	792	712	130
			270	35.0	9.5	1133	1020	120
			405	36.4	14.8	1662	1496	113
			540	37.8	20.4	2129	1917	104
Décor Ultra Vero 10	BXRC-30H1000-C-73	97	180	33.3	6.0	803	723	134
			240	33.8	8.1	1052	947	130
			360	35.0	12.6	1510	1359	120
			540	36.4	19.7	2199	1979	112
			720	37.7	27.1	2809	2528	104
Décor Ultra Vero 10	BXRC-30H1000-D-73	97	175	24.9	4.4	588	529	135
			233	25.4	5.9	771	694	130
			350	26.0	9.1	1101	991	121
			525	27.4	14.4	1621	1459	113
			700	28.4	19.9	2076	1869	104

Notes for Table 3:

1. Alternate drive currents in Table 3 are provided for reference only and are not a guarantee of performance.
2. Bridgelux maintains a $\pm 7\%$ tolerance on flux measurements.
3. Typical stabilized DC performance values are provided as reference only and are not a guarantee of performance.

Performance at Commonly Used Drive Currents

Table 3: Product Performance at Commonly Used Drive Currents (continued)

Product	Part Number	CRI	Drive Current ¹ (mA)	Typical V _f T _c = 25°C (V)	Typical Power T _c = 25°C (W)	Typical Flux ² T _c = 25°C (lm)	Typical DC Flux ³ T _c = 85°C (lm)	Typical Efficacy T _c = 25°C (lm/W)
Décor Ultra Vero 13	BXRC-27H2000-B-73	97	113	32.3	3.7	497	448	136
			225	33.2	7.5	963	866	129
			450	35.0	15.8	1826	1643	116
			675	36.3	24.5	2639	2375	108
			900	37.5	33.7	3366	3029	100
Décor Ultra Vero 13	BXRC-27H2000-C-73	97	158	32.3	5.1	691	622	135
			315	33.2	10.5	1337	1203	128
			630	35.0	22.1	2556	2300	116
			945	36.4	34.4	3669	3302	107
			1260	37.8	47.6	4682	4214	98
Décor Ultra Vero 13	BXRC-27H2000-D-73	97	125	29.6	3.7	492	443	133
			250	30.3	7.6	954	859	126
			500	31.8	15.9	1860	1674	117
			750	33.2	24.9	2628	2366	106
			1000	34.4	34.4	3361	3025	98
Décor Ultra Vero 13	BXRC-30H2000-B-73	97	113	32.3	3.7	531	478	145
			225	33.2	7.5	1028	926	138
			450	35.0	15.8	1951	1756	124
			675	36.3	24.5	2819	2538	115
			900	37.5	33.7	3596	3237	107
Décor Ultra Vero 13	BXRC-30H2000-C-73	97	158	32.3	5.1	738	664	144
			315	33.2	10.5	1428	1286	136
			630	35.0	22.1	2731	2458	124
			945	36.4	34.4	3920	3528	114
			1260	37.8	47.6	5003	4503	105
Décor Ultra Vero 13	BXRC-30H2000-D-73	97	125	29.6	3.7	526	473	142
			250	30.3	7.6	1020	918	134
			500	31.8	15.9	1987	1788	125
			750	33.2	24.9	2808	2527	113
			1000	34.4	34.4	3590	3231	104
Décor Ultra Vero 18	BXRC-27H4000-B-73	97	450	33.3	15.0	1961	1765	131
			600	33.9	20.4	2572	2315	126
			900	35.0	31.5	3652	3287	116
			1350	36.7	49.5	5432	4888	110
			1800	38.0	68.4	6990	6291	102
Décor Ultra Vero 18	BXRC-27H4000-C-73	97	585	33.4	19.5	2481	2233	127
			780	34.0	26.5	3251	2926	123
			1170	35.0	41.0	4748	4273	116
			1755	36.8	64.5	6830	6147	106
			2340	38.1	89.3	8762	7885	98
Décor Ultra Vero 18	BXRC-27H4000-D-73	97	525	27.7	14.6	1891	1702	130
			700	28.2	19.8	2459	2213	124
			1050	29.0	30.5	3550	3195	117
			1575	30.4	47.9	5071	4564	106
			2100	31.5	66.2	6455	5809	97

Notes for Table 3:

1. Alternate drive currents in Table 3 are provided for reference only and are not a guarantee of performance.
2. Bridgelux maintains a ± 7% tolerance on flux measurements.
3. Typical stabilized DC performance values are provided as reference only and are not a guarantee of performance.

Performance at Commonly Used Drive Currents

Table 3: Product Performance at Commonly Used Drive Currents (continued)

Product	Part Number	CRI	Drive Current ¹ (mA)	Typical V_f $T_c = 25^\circ\text{C}$ (V)	Typical Power $T_c = 25^\circ\text{C}$ (W)	Typical Flux ² $T_c = 25^\circ\text{C}$ (lm)	Typical DC Flux ³ $T_c = 85^\circ\text{C}$ (lm)	Typical Efficacy $T_c = 25^\circ\text{C}$ (lm/W)
Décor Ultra Vero 18	BXRC-30H4000-B-73	97	450	33.3	15.0	2094	1885	140
			600	33.9	20.4	2747	2473	135
			900	35.0	31.5	3901	3511	124
			1350	36.7	49.5	5802	5222	117
			1800	38.0	68.4	7466	6720	109
Décor Ultra Vero 18	BXRC-30H4000-C-73	97	585	33.4	19.5	2651	2386	136
			780	34.0	26.5	3473	3126	131
			1170	35.0	41.0	5073	4566	124
			1755	36.8	64.5	7298	6568	113
			2340	38.1	89.3	9361	8425	105
Décor Ultra Vero 18	BXRC-30H4000-D-73	97	525	27.7	14.6	2021	1818	139
			700	28.2	19.8	2627	2365	133
			1050	29.0	30.5	3793	3414	125
			1575	30.4	47.9	5418	4876	113
			2100	31.5	66.2	6897	6207	104
Décor Food Vero 18	BXRC-17E4000-B-73	80	450	33.3	15.0	1441	1297	96
			600	33.9	20.4	1890	1701	93
			900	35.0	31.5	2684	2416	85
			1350	36.7	49.5	3992	3593	81
			1800	38.0	68.4	5137	4623	75
Décor Food Vero 18	BXRC-17E4000-C-73	80	585	33.4	19.5	1823	1641	93
			780	34.0	26.5	2390	2151	90
			1170	35.0	41.0	3490	3141	85
			1755	36.8	64.5	5021	4519	78
			2340	38.1	89.3	6440	5796	72
Décor Food Vero 18	BXRC-17E4000-D-73	80	525	27.7	14.6	1390	1251	95
			700	28.2	19.8	1808	1627	92
			1050	29.0	30.5	2610	2349	86
			1575	30.4	47.9	3728	3355	78
			2100	31.5	66.2	4746	4271	72
Décor Food Vero 18	BXRC-25E4000-B-73	80	450	33.3	15.0	2329	2096	155
			600	33.9	20.4	3055	2750	150
			900	35.0	31.5	4338	3904	138
			1350	36.7	49.5	6452	5807	130
			1800	38.0	68.4	8302	7472	121
Décor Food Vero 18	BXRC-25E4000-C-73	80	585	33.4	19.5	2947	2653	151
			780	34.0	26.5	3862	3476	146
			1170	35.0	41.0	5641	5077	138
			1755	36.8	64.5	8115	7304	126
			2340	38.1	89.3	10409	9369	117
Décor Food Vero 18	BXRC-25E4000-D-73	80	525	27.7	14.6	2247	2022	154
			700	28.2	19.8	2922	2630	148
			1050	29.0	30.5	4218	3796	139
			1575	30.4	47.9	6025	5422	126
			2100	31.5	66.2	7670	6903	116

Notes for Table 3:

1. Alternate drive currents in Table 3 are provided for reference only and are not a guarantee of performance.
2. Bridgelux maintains a $\pm 7\%$ tolerance on flux measurements.
3. Typical stabilized DC performance values are provided as reference only and are not a guarantee of performance.

Performance at Commonly Used Drive Currents

Table 3: Product Performance at Commonly Used Drive Currents (continued)

Product	Part Number	CRI	Drive Current ¹ (mA)	Typical V _f T _c = 25°C (V)	Typical Power T _c = 25°C (W)	Typical Flux ² T _c = 25°C (lm)	Typical DC Flux ³ T _c = 85°C (lm)	Typical Efficacy T _c = 25°C (lm/W)
Décor Specialty Vero 18	BXRC-56G4001-B-74	90	450	33.3	15.0	2480	2232	165
			600	33.9	20.4	3253	2928	160
			900	35.0	31.5	4619	4157	147
			1350	36.7	49.5	6870	6183	139
			1800	38.0	68.4	8840	7956	129
Décor Specialty Vero 18	BXRC-56G4001-C-74	90	585	33.4	19.5	3138	2824	161
			780	34.0	26.5	4112	3701	155
			1170	35.0	41.0	6006	5405	147
			1755	36.8	64.5	8640	7776	134
			2340	38.1	89.3	11083	9975	124
Décor Specialty Vero 18	BXRC-56G4001-D-74	90	525	27.7	14.6	2392	2153	164
			700	28.2	19.8	3111	2800	157
			1050	29.0	30.5	4491	4042	147
			1575	30.4	47.9	6415	5773	134
			2100	31.5	66.2	8166	7349	123
Décor Food Vero 29	BXRC-17E10K0-B-74	80	900	49.6	44.7	4220	3798	94
			1200	50.5	60.6	5568	5011	92
			1800	52.0	93.6	8053	7248	86
			2700	54.1	146.1	11873	10686	81
			3600	55.8	201.0	15309	13778	76
Décor Food Vero 29	BXRC-17E10K0-C-74	80	855	66.2	56.6	5794	5215	102
			1140	67.3	76.7	7365	6628	96
			1710	69.4	118.7	10200	9180	86
			2565	72.1	185.0	14470	13023	78
			3420	74.4	254.6	18137	16323	71
Décor Food Vero 29	BXRC-17E10K0-D-74	80	1050	35.4	37.2	3732	3359	100
			1400	36.2	50.7	4803	4323	95
			2100	37.6	78.9	6785	6107	86
			3150	39.5	124.4	6845	6161	55
			4200	41.2	173.0	9659	8694	56

Notes for Table 3:

1. Alternate drive currents in Table 3 are provided for reference only and are not a guarantee of performance.
2. Bridgelux maintains a ± 7% tolerance on flux measurements.
3. Typical stabilized DC performance values are provided as reference only and are not a guarantee of performance.

Performance at Commonly Used Drive Currents

Table 3: Product Performance at Commonly Used Drive Currents (continued)

Product	Part Number	CRI	Drive Current ¹ (mA)	Typical V _f T _c = 25°C (V)	Typical Power T _c = 25°C (W)	Typical Flux ² T _c = 25°C (lm)	Typical DC Flux ³ T _c = 85°C (lm)	Typical Efficacy T _c = 25°C (lm/W)
Décor Food Vero 29	BXRC-25E10K0-B-74	80	900	49.6	44.7	6820	6138	153
			1200	50.5	60.6	8999	8099	149
			1800	52.0	93.6	13016	11714	139
			2700	54.1	146.1	19191	17272	131
			3600	55.8	201.0	24743	22269	123
Décor Food Vero 29	BXRC-25E10K0-C-74	80	855	66.2	56.6	9366	8429	166
			1140	67.3	76.7	11904	10713	155
			1710	69.4	118.7	16487	14838	139
			2565	72.1	185.0	23389	21050	126
			3420	74.4	254.6	29316	26384	115
Décor Food Vero 29	BXRC-25E10K0-D-74	80	1050	35.4	37.2	6032	5429	162
			1400	36.2	50.7	7764	6987	153
			2100	37.6	78.9	10967	9870	139
			3150	39.5	124.4	15613	14052	125
			4200	41.2	173.0	19678	17710	114
Décor Specialty Vero 29	BXRC-56G10K1-B-74	90	900	49.6	44.7	7262	6536	163
			1200	50.5	60.6	9582	8624	158
			1800	52.0	93.6	13859	12473	148
			2700	54.1	146.1	20434	18390	140
			3600	55.8	201.0	26346	23711	131
Décor Specialty Vero 29	BXRC-56G10K1-C-74	90	855	66.2	56.6	9972	8975	176
			1140	67.3	76.7	12674	11407	165
			1710	69.4	118.7	17554	15799	148
			2565	72.1	185.0	24903	22412	135
			3420	74.4	254.6	31213	28092	123
Décor Specialty Vero 29	BXRC-56G10K1-D-74	90	1050	35.4	37.2	6423	5781	173
			1400	36.2	50.7	8266	7440	163
			2100	37.6	78.9	11677	10509	148
			3150	39.5	124.4	16624	14962	134
			4200	41.2	173.0	20952	18857	121

Notes for Table 3:

1. Alternate drive currents in Table 3 are provided for reference only and are not a guarantee of performance.
2. Bridgelux maintains a ± 7% tolerance on flux measurements.
3. Typical stabilized DC performance values are provided as reference only and are not a guarantee of performance.

Electrical Characteristics

Table 4: Electrical Characteristics

Part Number	Nominal Drive Current ¹ (mA)	Forward Voltage Pulsed, T _c = 25°C (V) ^{1,2,3,8}			Typical Coefficient of Forward Voltage ⁴ ΔV _f /ΔT _c (mV/°C)	Typical Thermal Resistance Junction to Case ^{5,6} R _{j-c} (C/W)	Driver Selection Voltages ⁷ (V)	
		Minimum	Typical	Maximum			V _f Min. Hot T _c = 105°C (V)	V _f Max. Cold ⁴ T _c = -40°C (V)
BXRC-xxx100x-B-7x	270	32.4	35.0	37.6	-16.1	0.49	31.1	38.7
	540	34.9	37.8	40.6	-16.1	0.57	33.6	41.6
BXRC-xxx100x-C-7x	360	32.4	35.0	37.6	-16.1	0.37	31.1	38.7
	720	34.9	37.7	40.5	-16.1	0.43	33.6	41.6
BXRC-xxx100x-D-7x	350	24.1	26.0	28.0	-11.8	0.49	23.1	28.7
	700	26.3	28.4	30.5	-11.8	0.57	25.3	31.3
BXRC-xxx200x-B-7x	450	32.4	35.0	37.6	-14.9	0.28	31.2	38.6
	900	34.7	37.5	40.3	-14.9	0.35	33.5	41.3
BXRC-xxx200x-C-7x	630	32.4	35.0	37.6	-14.5	0.20	31.2	38.6
	1260	34.9	37.8	40.6	-14.9	0.24	33.7	41.6
BXRC-xxx200x-D-7x	500	29.4	31.8	34.2	-14.9	0.34	28.2	35.2
	1000	31.8	34.4	37.0	-14.5	0.41	30.7	38.0
BXRC-xxx400x-B-7x	900	32.4	35.0	37.6	-14.9	0.15	31.2	38.6
	1800	35.2	38.0	40.9	-14.9	0.19	34.0	41.8
BXRC-xxx400x-C-7x	1170	32.4	35.0	37.6	-12.2	0.11	31.4	38.4
	2340	35.3	38.1	41.0	-14.9	0.13	34.1	42.0
BXRC-xxx400x-D-7x	1050	26.8	29.0	31.2	-14.9	0.16	25.6	32.1
	2100	29.2	31.5	33.9	-12.2	0.19	28.2	34.7
BXRC-xxx10Kx-B-7x	1800	48.1	52.0	55.9	-22.1	0.06	46.3	57.3
	3600	51.7	55.8	60.0	-22.1	0.07	49.9	61.5
BXRC-xxx10Kx-C-7x	1710	64.2	69.4	74.6	-17.4	0.04	62.8	75.7
	3420	68.8	74.4	80.0	-22.1	0.05	67.1	81.4
BXRC-xxx10Kx-D-7x	2100	34.8	37.6	40.4	-22.1	0.06	33.0	41.9
	4200	38.1	41.2	44.3	-17.4	0.07	36.7	45.4

Notes for Table 4:

- Parts are tested in pulsed conditions, T_c = 25°C. Pulse width is 10ms.
- Voltage minimum and maximum are provided for reference only and are not a guarantee of performance.
- Bridgelux maintains a tester tolerance of ± 0.10V on forward voltage measurements.
- Typical coefficient of forward voltage tolerance is ± 0.1mV for nominal current.
- Thermal resistance values are based from test data of a 3000K 80 CRI product.
- Thermal resistance value was calculated using total electrical input power; optical power was not subtracted from input power. The thermal interface material used during testing is not included in the thermal resistance value.
- V_f min hot and max cold values are provided as reference only and are not guaranteed by test. These values are provided to aid in driver design and selection over the operating range of the product.
- This product has been designed and manufactured per IEC 62031:2014. This product has passed dielectric withstand voltage testing at 1120 V. The working voltage designated for the insulation is 60V d.c. The maximum allowable voltage across the array must be determined in the end product application.

Absolute Maximum Ratings

Table 5: Maximum Ratings

Parameter	Maximum Rating		
LED Junction Temperature	125°C		
Storage Temperature	-40°C to +105°C		
Operating Case Temperature ¹	105°C		
Soldering Temperature ²	350°C or lower for a maximum of 10 seconds		
	BXRC-xxx100x-B-7x	BXRC-xxx100x-C-7x	BXRC-xxx100x-D-7x
Maximum Drive Current ³	540mA	720mA	700mA
Maximum Peak Pulsed Drive Current ⁴	771mA	1029mA	1000mA
Maximum Reverse Voltage ⁵	-60V	-60V	-45V

	BXRC-xxx200x-B-7x	BXRC-xxx200x-C-7x	BXRC-xxx200x-D-7x
Maximum Drive Current ³	900mA	1260mA	1000mA
Maximum Peak Pulsed Drive Current ⁴	1286mA	1800mA	1429mA
Maximum Reverse Voltage ⁵	-60V	-60V	-55V

	BXRC-xxx400x-B-7x	BXRC-xxx400x-C-7x	BXRC-xxx400x-D-7x
Maximum Drive Current ³	1800mA	2340mA	2100mA
Maximum Peak Pulsed Drive Current ⁴	2571mA	3343mA	3000mA
Maximum Reverse Voltage ⁵	-60V	-60V	-50V

	BXRC-xxx10Kx-B-7x	BXRC-xxx10Kx-C-7x	BXRC-xxx10Kx-D-7x
Maximum Drive Current ³	3600mA	3420mA	4200mA
Maximum Peak Pulsed Drive Current ⁴	5143mA	4886mA	6000mA
Maximum Reverse Voltage ⁵	-90V	-120V	-65V

Notes for Table 5:

- For IEC 62717 requirement, please contact Bridgelux Sales Support.
- Refer to Bridgelux Application Note AN31, Handling and Assembly of Bridgelux Vero LED arrays, for more information.
- Arrays may be driven at higher currents however lumen maintenance may be reduced.
- Bridgelux recommends a maximum duty cycle of 10% and pulse width of 20ms when operating LED Arrays at the maximum peak pulsed current specified. Maximum peak pulsed current indicate values where the LED array can be driven without catastrophic failures.
- Light emitting diodes are not designed to be driven in reverse voltage and will not produce light under this condition. Maximum rating provided for reference only.

Performance Curves

Figure 1: Vero 10B Drive Current vs. Forward Voltage
($T_j=T_c=25^\circ\text{C}$)

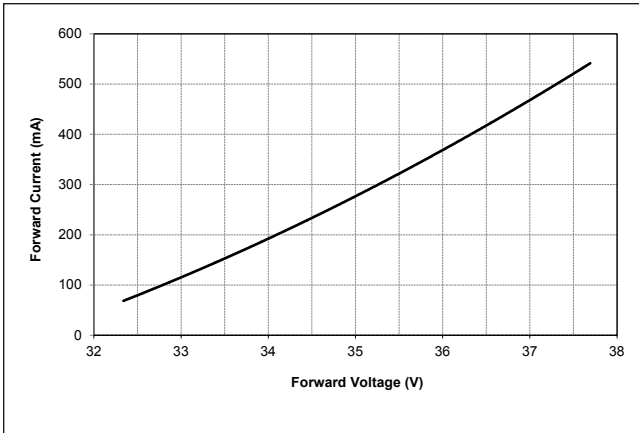

Figure 2: Vero 10C Drive Current vs. Forward Voltage
($T_j=T_c=25^\circ\text{C}$)

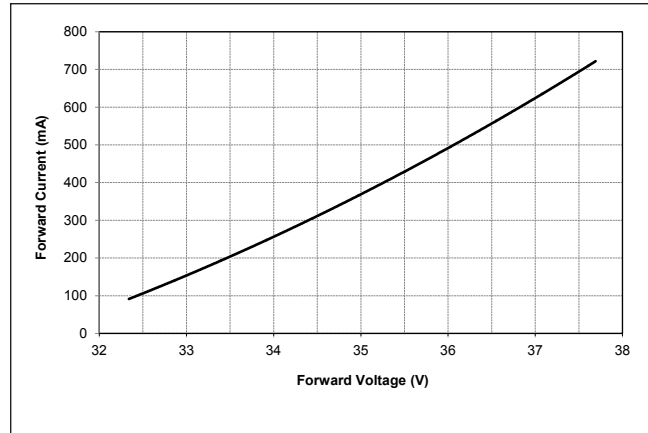

Figure 3: Vero 10D Drive Current vs. Forward Voltage
($T_j=T_c=25^\circ\text{C}$)

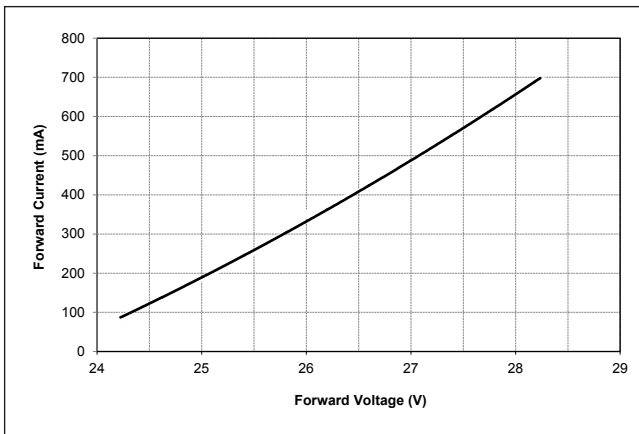

Figure 4: Vero 13B Drive Current vs. Forward Voltage
($T_j=T_c=25^\circ\text{C}$)

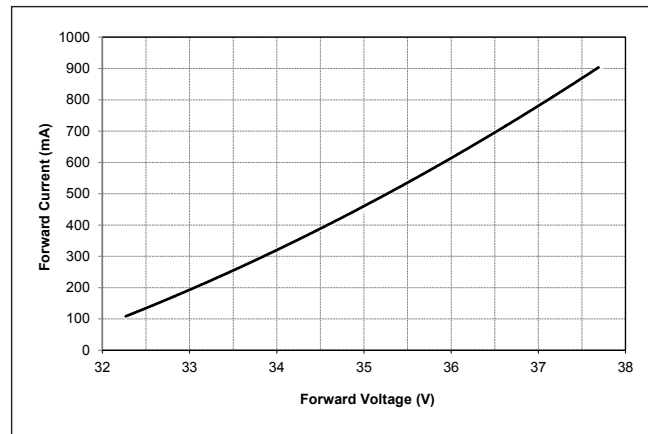

Figure 5: Vero 13C Drive Current vs. Forward Voltage
($T_j=T_c=25^\circ\text{C}$)

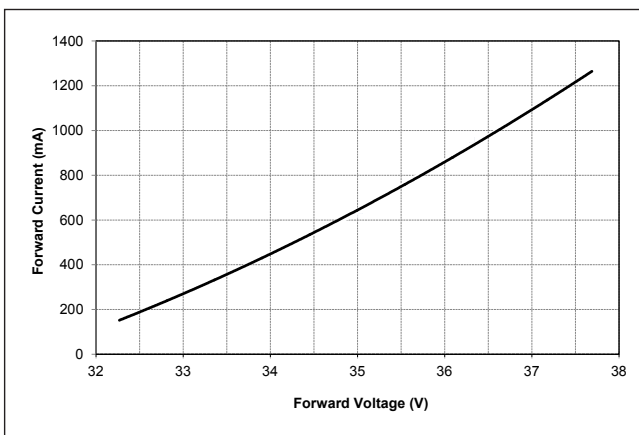
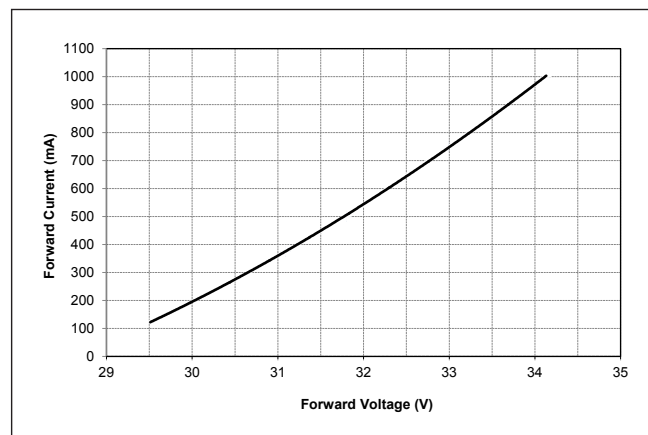

Figure 6: Vero 13D Drive Current vs. Forward Voltage
($T_j=T_c=25^\circ\text{C}$)



Performance Curves

Figure 7: Vero 18B Drive Current vs. Forward Voltage
($T_j=T_c=25^\circ\text{C}$)

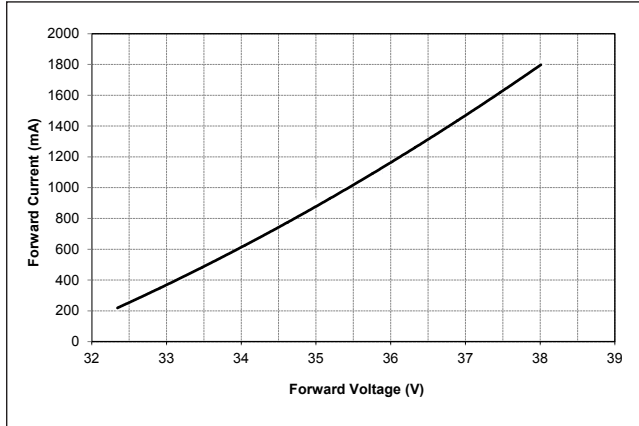

Figure 8: Vero 18C Drive Current vs. Forward Voltage
($T_j=T_c=25^\circ\text{C}$)

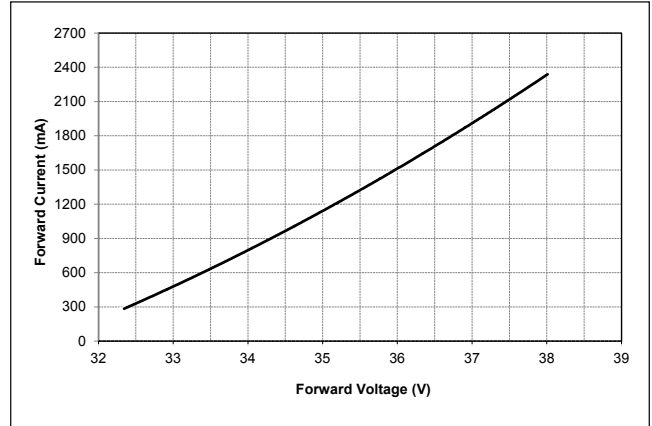

Figure 9: Vero 18D Drive Current vs. Forward Voltage
($T_j=T_c=25^\circ\text{C}$)

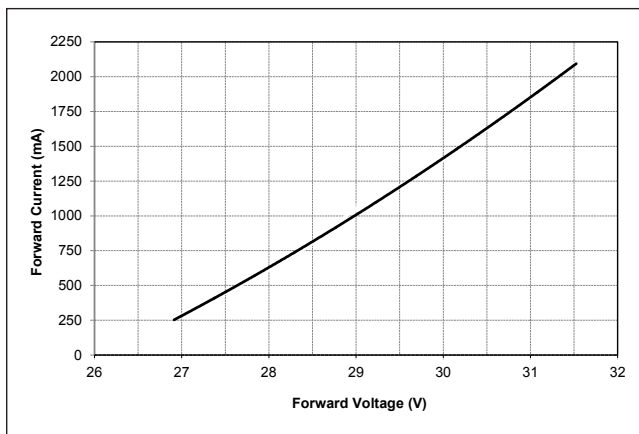

Figure 10: Vero 29B Drive Current vs. Forward Voltage
($T_j=T_c=25^\circ\text{C}$)

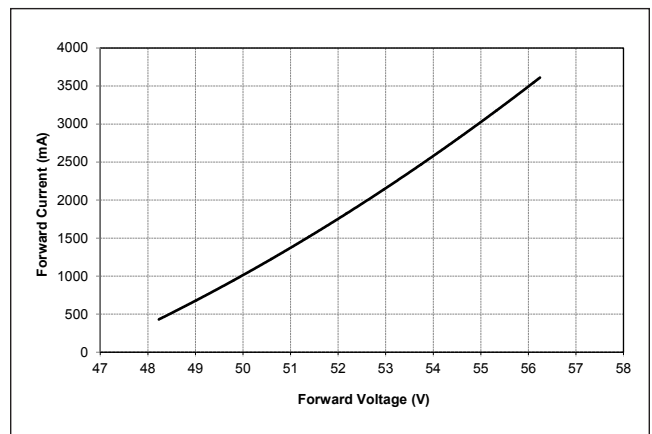

Figure 11: Vero 29C Drive Current vs. Forward Voltage
($T_j=T_c=25^\circ\text{C}$)

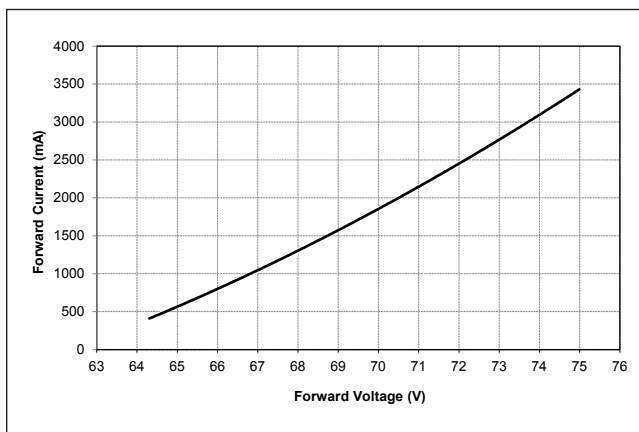
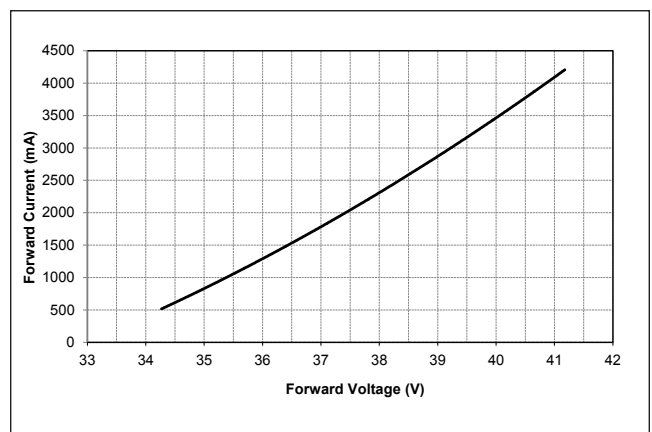

Figure 12: Vero 29D Drive Current vs. Forward Voltage
($T_j=T_c=25^\circ\text{C}$)



Performance Curves

Figure 13: Vero 10B Typical Relative Luminous Flux vs. Drive Current

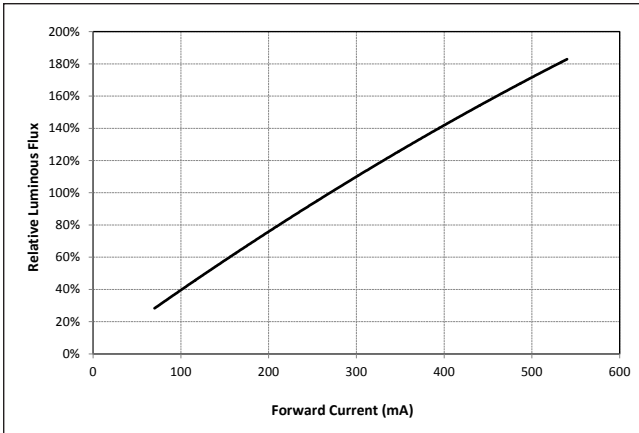

Figure 14: Vero 10C Typical Relative Luminous Flux vs. Drive Current

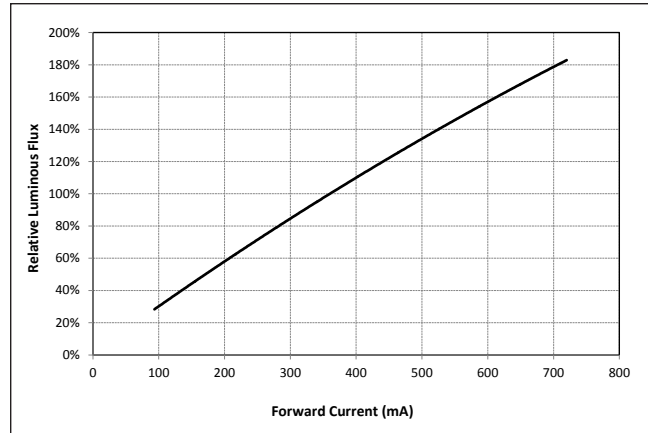

Figure 15: Vero 10D Typical Relative Luminous Flux vs. Drive Current

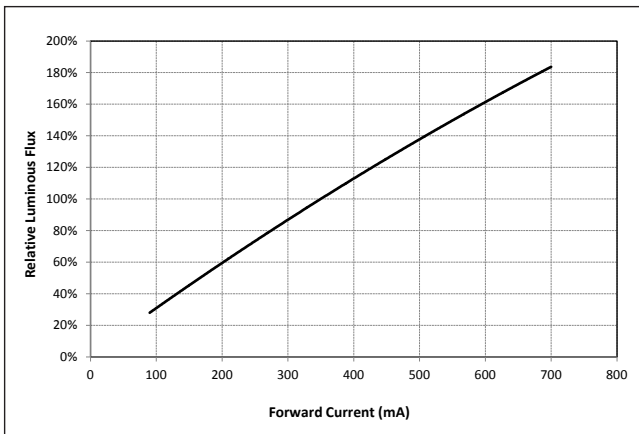

Figure 16: Vero 13B Typical Relative Luminous Flux vs. Drive Current

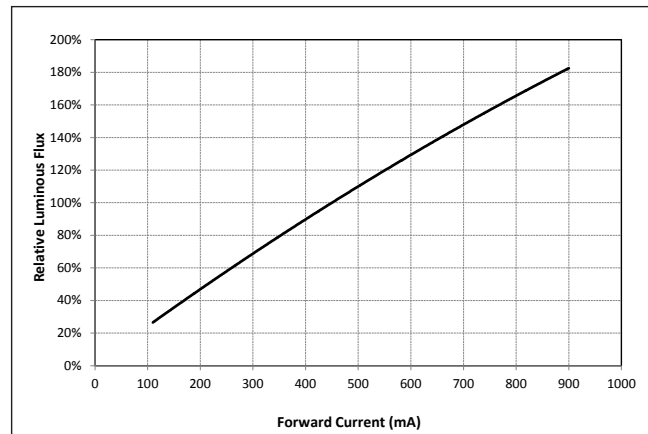

Figure 17: Vero 13C Typical Relative Luminous Flux vs. Drive Current

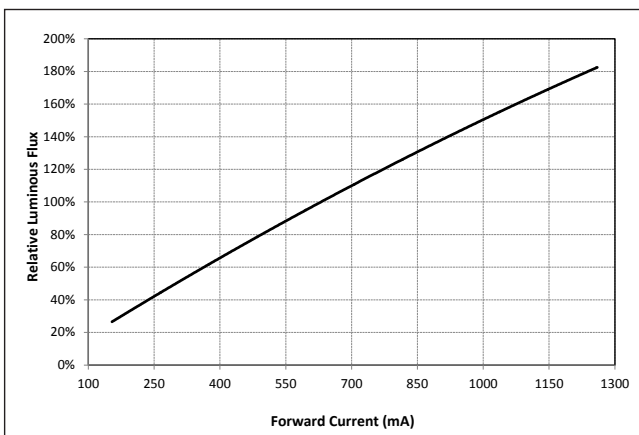
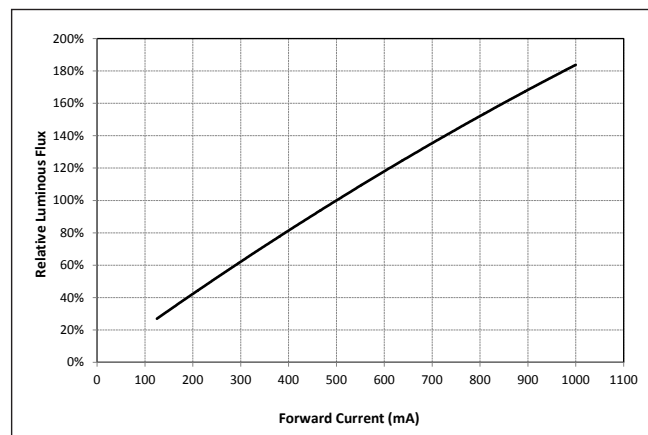

Figure 18: Vero 13D Typical Relative Luminous Flux vs. Drive Current



Performance Curves

Figure 19: Vero 18B Typical Relative Luminous Flux vs. Drive Current

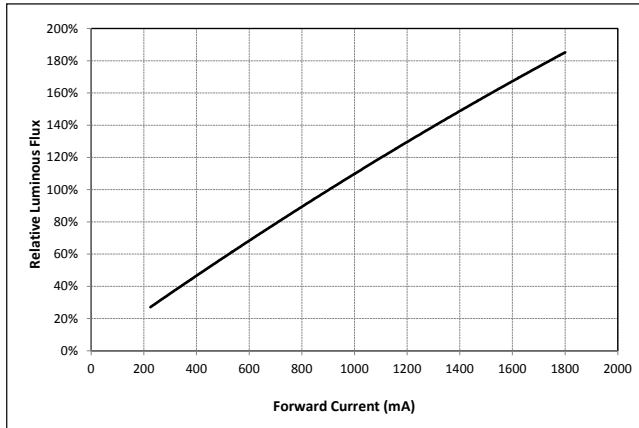

Figure 20: Vero 18C Typical Relative Luminous Flux vs. Drive Current

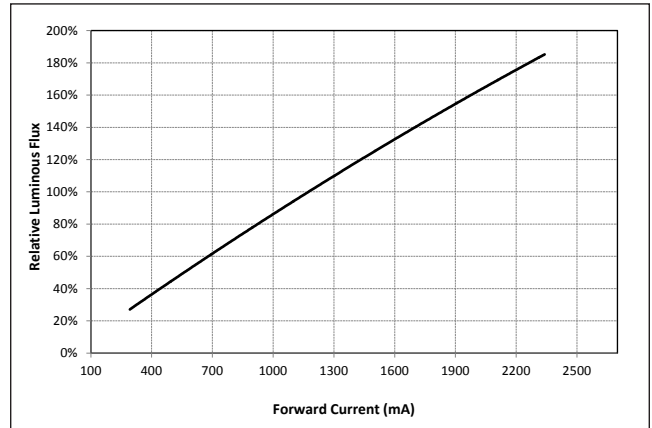

Figure 21: Vero 18D Typical Relative Luminous Flux vs. Drive Current

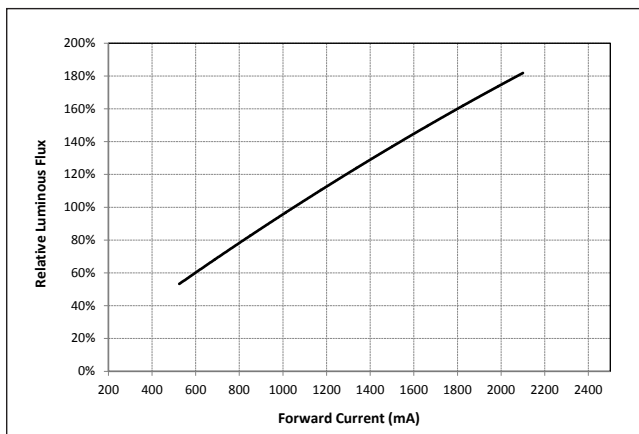

Figure 22: Vero 29B Typical Relative Luminous Flux vs. Drive Current

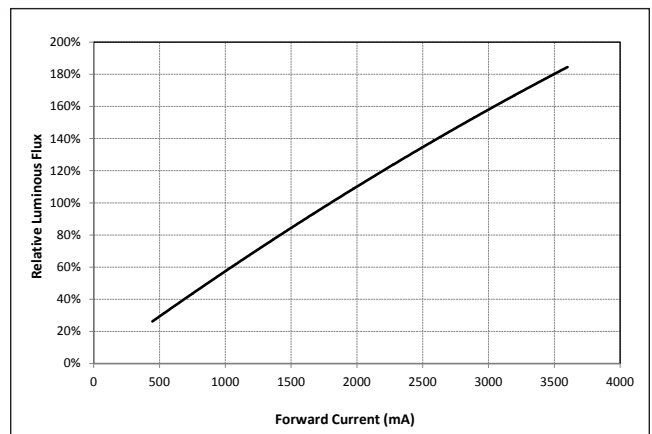

Figure 23: Vero 29C Typical Relative Luminous Flux vs. Drive Current

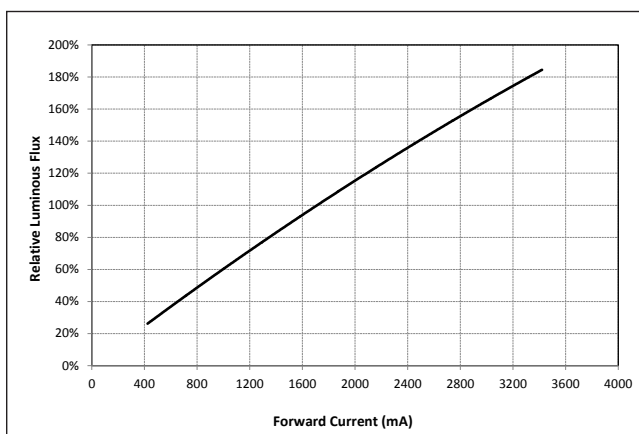
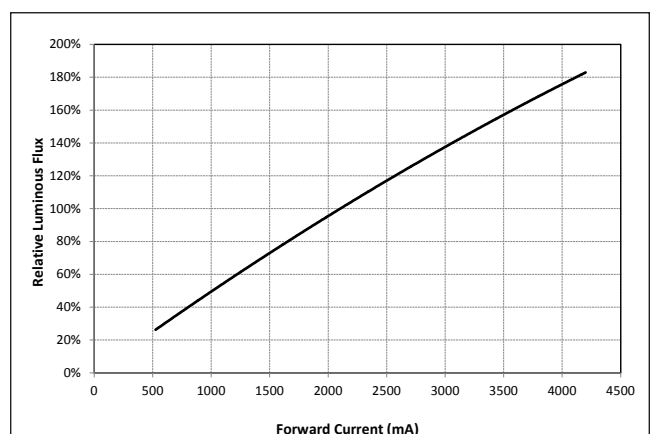

Figure 24: Vero 29D Typical Relative Luminous Flux vs. Drive Current



Performance Curves

Figure 25: Vero 10 Typical DC Flux vs. Case Temperature

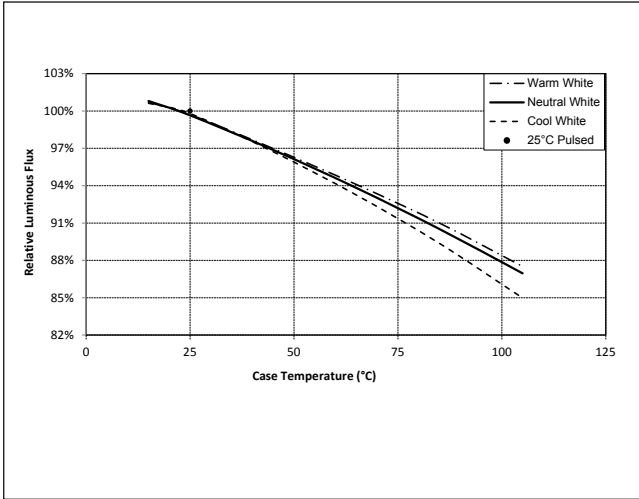

Figure 26: Vero 13 Typical DC Flux vs. Case Temperature

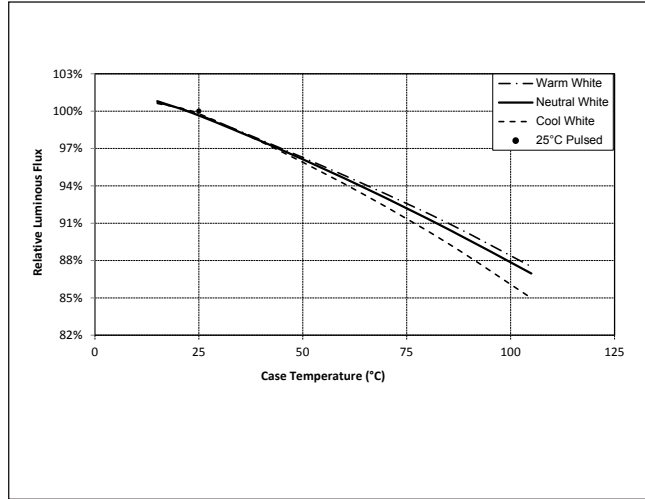

Figure 27: Vero 18 Typical DC Flux vs. Case Temperature

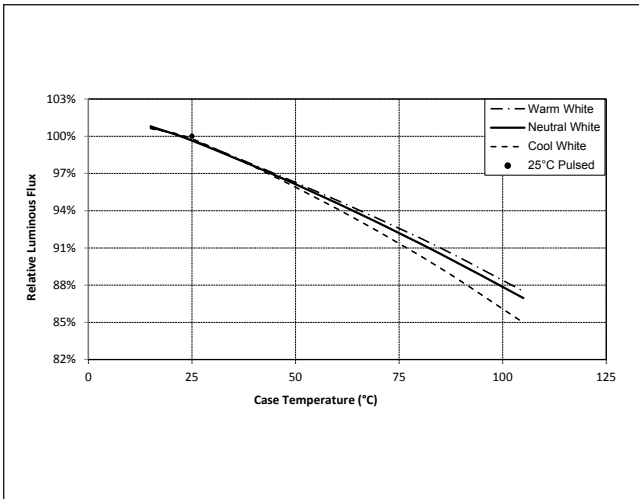
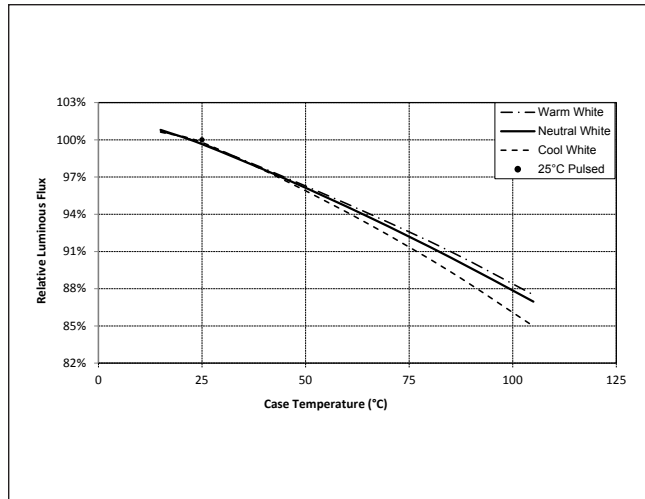

Figure 28: Vero 29 Typical DC Flux vs. Case Temperature



Note for Figures 25-28:

1. Flux measurements taken under DC conditions.
2. Characteristics shown for warm white based on 3000K and 80 CRI.
3. Characteristics shown for neutral white based on 4000K and 80 CRI.
4. Characteristics shown for cool white based on 5000K and 70 CRI.
5. For other color SKUs, the shift in color will vary. Please contact your Bridgelux Sales Representative for more information.

Performance Curves

Figure 29: 1750K Color Shift vs. Case Temperature¹

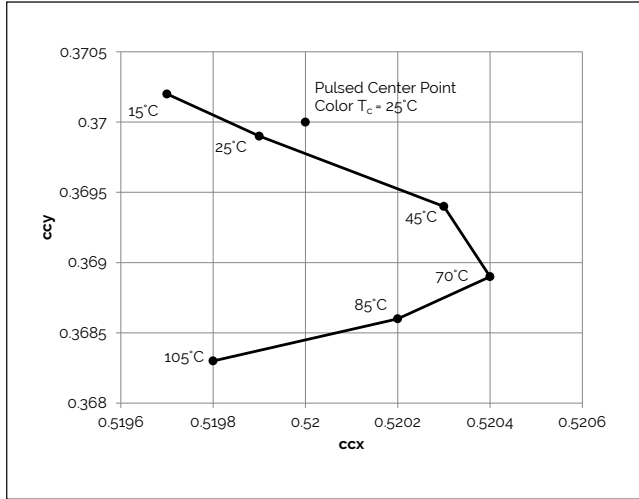

Figure 30: 2500K Color Shift vs. Case Temperature¹

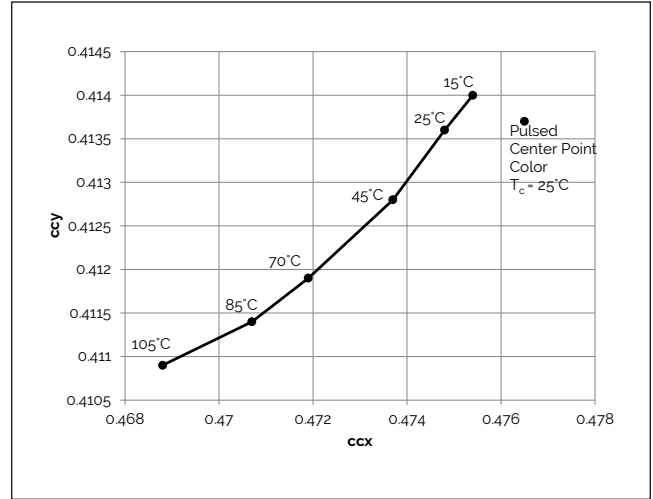

Figure 31: 2700K Color Shift vs. Case Temperature¹

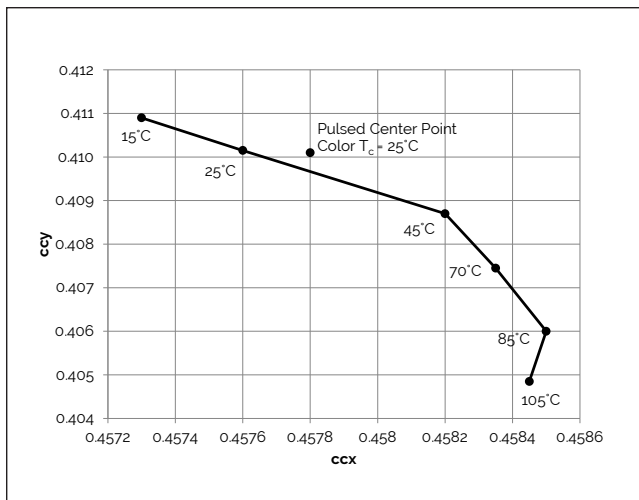
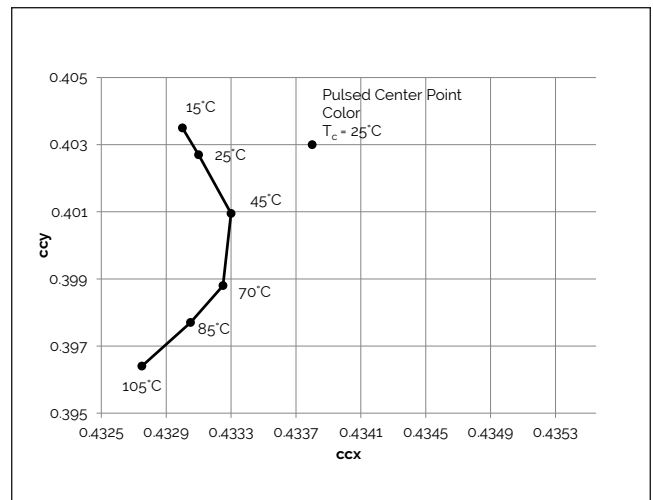

Figure 32: 3000K Color Shift vs. Case Temperature¹



Note for Figures 29-32:

1. Measurements made under DC test conditions at the nominal drive current.
2. Typical color shift is shown with a tolerance of ± 0.002 .

Performance Curves

Figure 33: 5600K Color Shift vs. Case Temperature¹

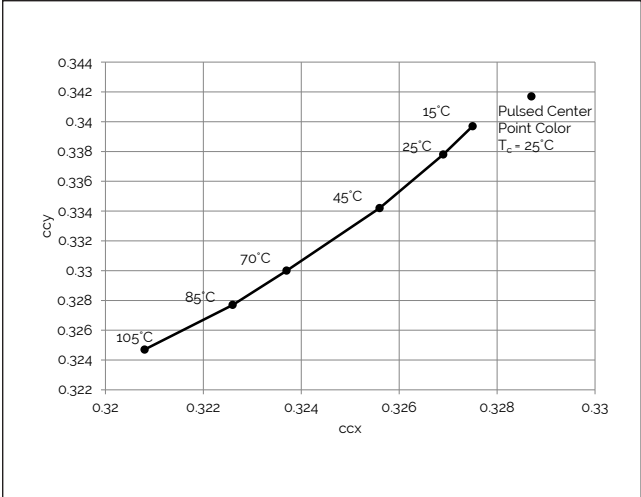

Note for Figure 33:

- 1. Measurements made under DC test conditions at the nominal drive current.
- 2. Typical color shift is shown with a tolerance of ±0.002.

Typical Radiation Pattern

Figure 34: Typical Spatial Radiation Pattern

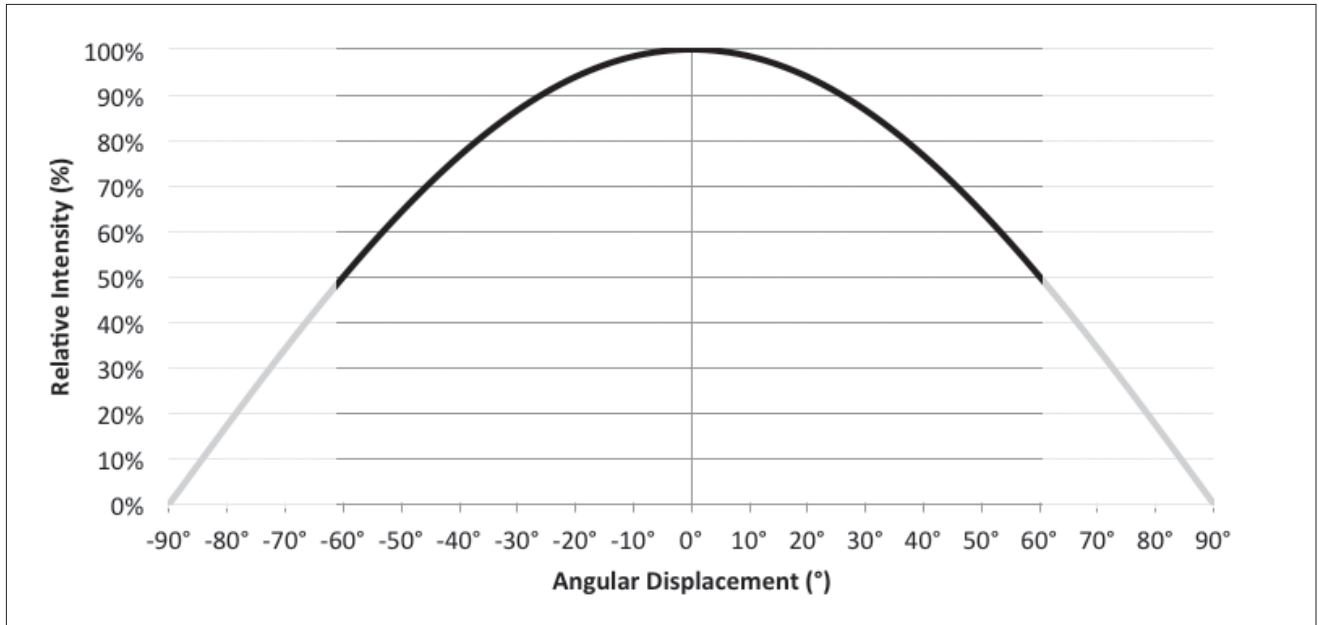

Notes for Figure 34:

1. Typical viewing angle is 120°.
2. The viewing angle is defined as the off axis angle from the centerline where I_v is $\frac{1}{2}$ of the peak value.

Figure 35: Typical Polar Radiation Pattern

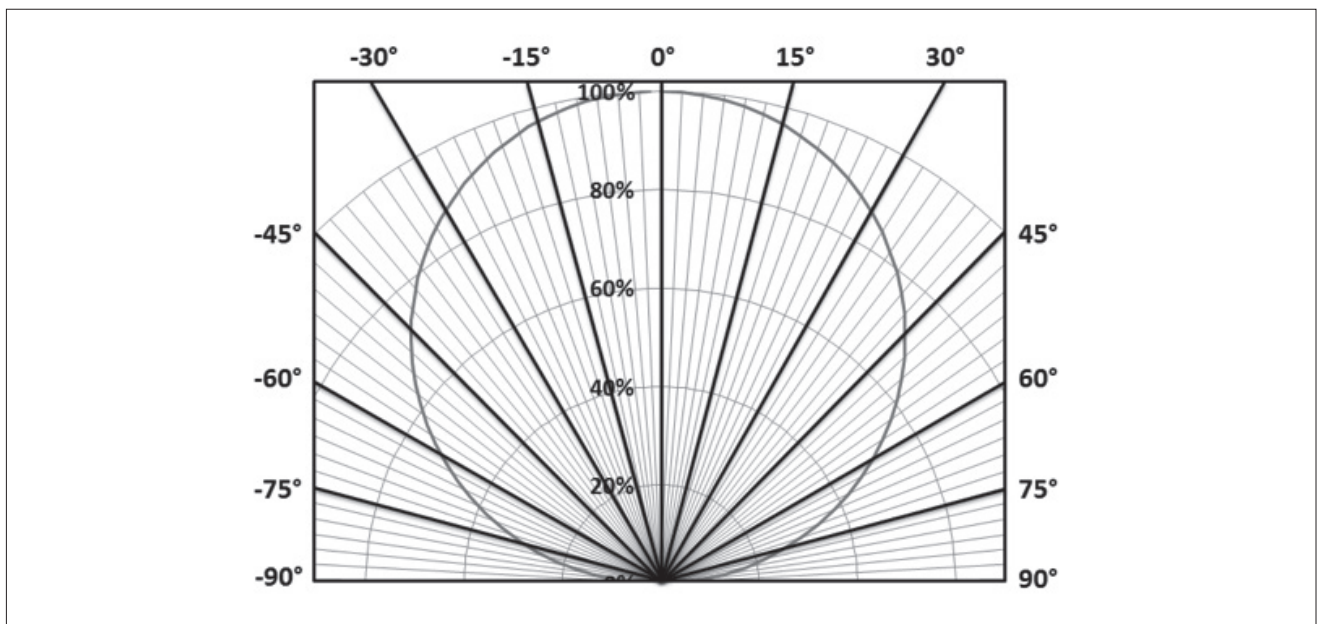

Typical Color Spectrum

97 CRI- Wavelength & CRI Characteristics at Drive Current, $T_c=25^\circ\text{C}$

The high CRI light delivered by the Bridgelux Vero Décor products reproduces colors faithfully compared with natural light. Figure 36 displays the spectral curve of Décor.

Table 6 compares CRI R values of Décor to other light sources. The typical overall CRI (Ra) of 97 results in excellent color representation - especially for colors which the human eye is particularly sensitive.

Décor delivers high typical values of R9 (98) and R15 (98). These are important attributes for the perception of realistic colors. R9 enhances red colors and R15 enables realistic rendering of human skin tones.

Figure 36: Typical Color Spectrum

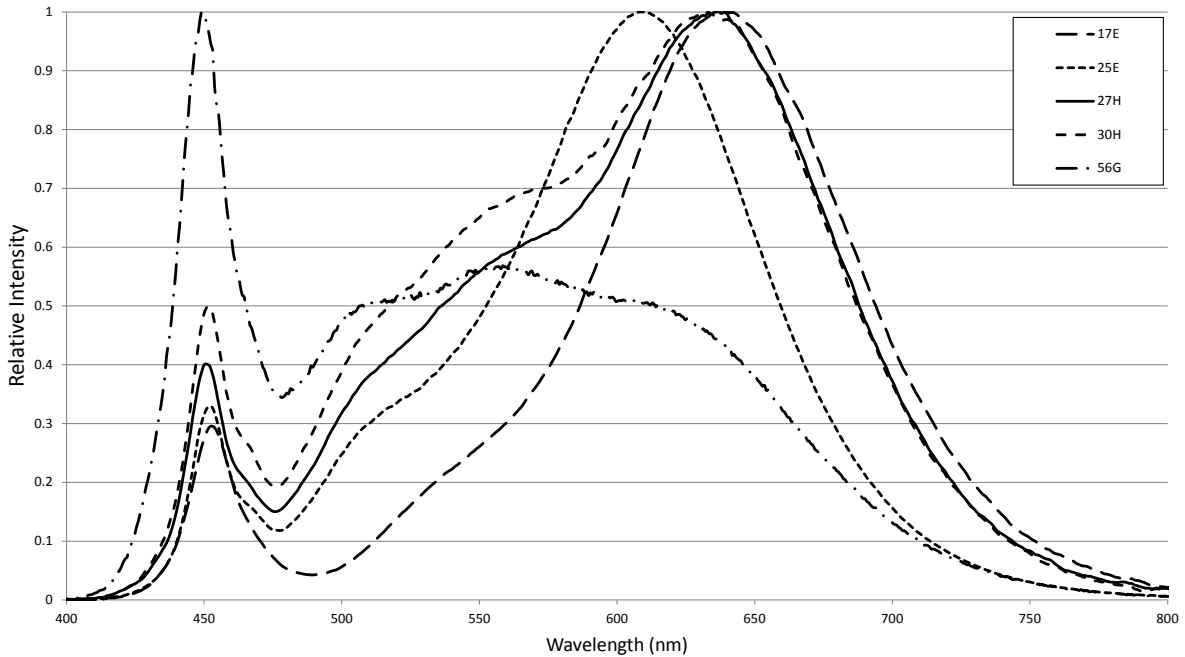
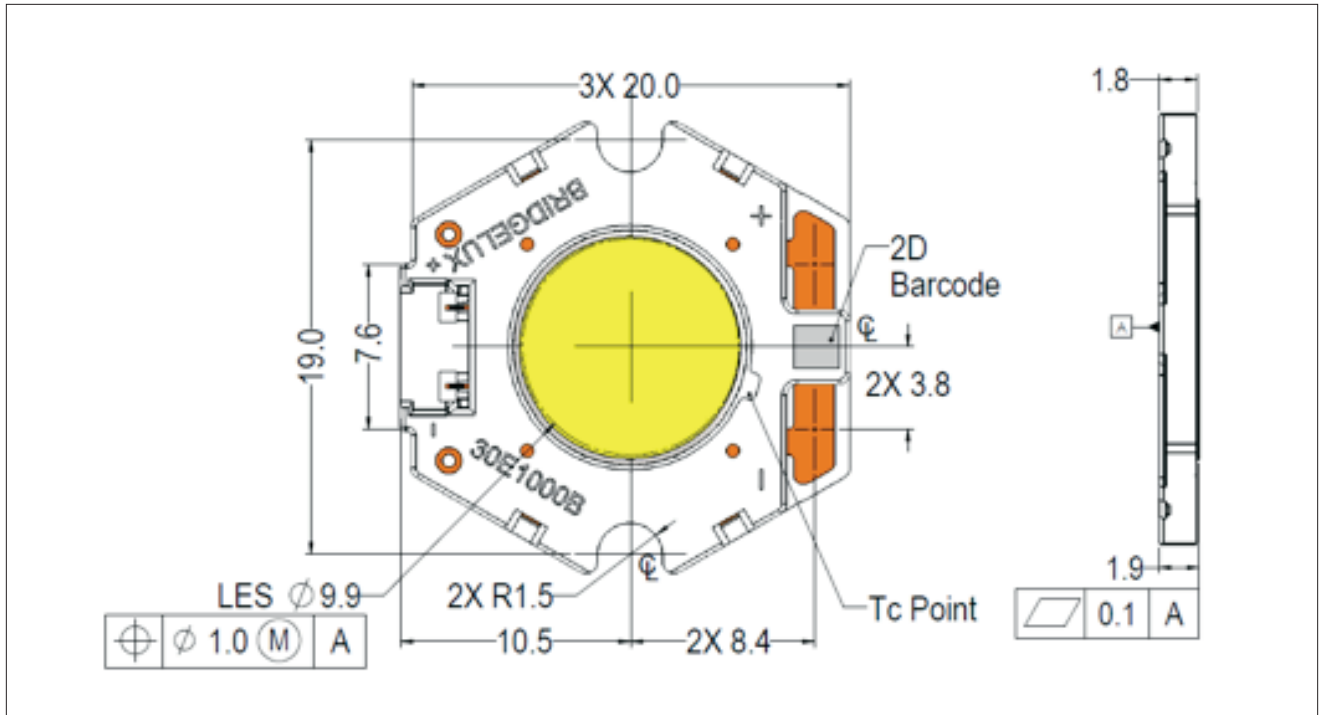

Table 6: CRI Spectra for Décor Ultra Products vs. Alternative Light Sources

Light Source	Ra	R1	R2	R3	R4	R5	R6	R7	R8	R9	R10	R11	R12	R13	R14	R15
Bridgelux Décor Ultra	97	97	100	96	96	98	98	99	98	98	99	92	87	98	97	98
Typical Halogen	98	98	99	99	99	98	98	99	97	92	97	98	97	98	99	97
Typical Metal Halide	82	90	94	69	82	81	81	87	71	27	59	62	55	93	78	88
Typical Compact Fluorescent	87	91	93	86	91	89	90	88	70	17	76	91	81	93	92	81

Mechanical Dimensions

Figure 37: Drawing for Vero 10 LED Array



Notes for Figure 37:

1. Drawings are not to scale.
2. Drawing dimensions are in millimeters.
3. Unless otherwise specified, tolerances are ± 0.10 mm.
4. Mounting slots (2X) are for M2.5 screws.
5. Bridgelux recommends two tapped holes for mounting screws with 19.0 ± 0.10 mm center-to-center spacing.
6. Screws with flat shoulders (pan, dome, button, round, truss, mushroom) provide optimal torque control. Do NOT use flat, countersink, or raised head screws.
7. Solder pads and connector port are labeled "+" and "-" to denote positive and negative, respectively.
8. It is not necessary to provide electrical connections to both the solder pads and the connector port. Either set may be used depending on application specific design requirements.
9. Refer to Application Notes AN30 and AN31 for product handling, mounting and heat sink recommendations.
10. The optical center of the LED Array is nominally defined by the mechanical center of the array to a tolerance of ± 0.2 mm.
11. Bridgelux maintains a flatness of 0.10mm across the mounting surface of the array.

Mechanical Dimensions

Figure 38: Drawing for Vero 13 LED Array

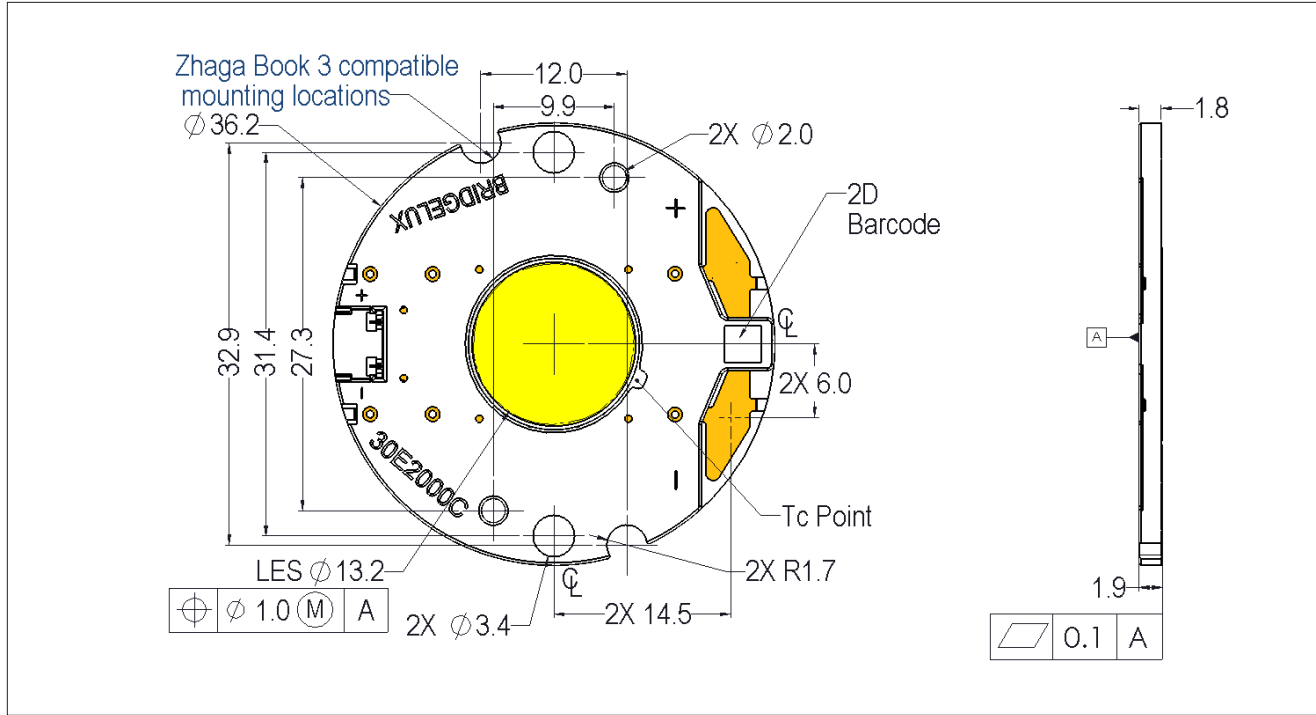

Notes for Figure 38:

1. Drawings are not to scale.
2. Drawing dimensions are in millimeters.
3. Unless otherwise specified, tolerances are $\pm 0.10\text{mm}$.
4. Mounting holes (2X) are for M2.5 screws.
5. Bridgelux recommends two tapped holes for mounting screws with $31.4 \pm 0.10\text{mm}$ center-to-center spacing.
6. Screws with flat shoulders (pan, dome, button, round, truss, mushroom) provide optimal torque control. Do NOT use flat, countersink, or raised head screws.
7. Solder pads and connector port are labeled "+" and "-" to denote positive and negative, respectively.
8. It is not necessary to provide electrical connections to both the solder pads and the connector port. Either set may be used depending on application specific design requirements.
9. Refer to Application Notes AN30 and AN31 for product handling, mounting and heat sink recommendations.
10. The optical center of the LED Array is nominally defined by the mechanical center of the array to a tolerance of $\pm 0.2\text{mm}$.
11. Bridgelux maintains a flatness of 0.10mm across the mounting surface of the array.

Mechanical Dimensions

Figure 39: Drawing for Vero 18 LED Array

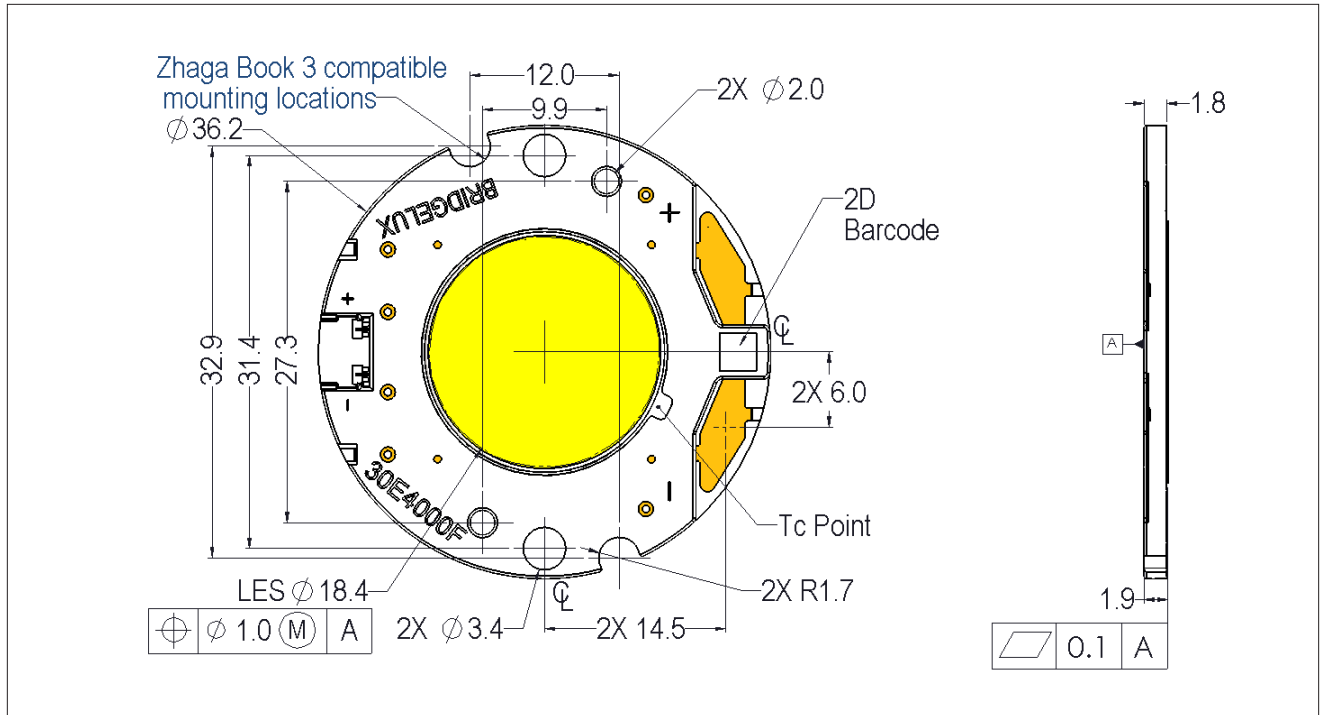

Notes for Figure 39:

1. Drawings are not to scale.
2. Drawing dimensions are in millimeters.
3. Unless otherwise specified, tolerances are $\pm 0.10\text{mm}$.
4. Mounting holes (2X) are for M2.5 screws.
5. Bridgelux recommends two tapped holes for mounting screws with $31.4 \pm 0.10\text{mm}$ center-to-center spacing.
6. Screws with flat shoulders (pan, dome, button, round, truss, mushroom) provide optimal torque control. Do NOT use flat, countersink, or raised head screws.
7. Solder pads and connector port are labeled "+" and "-" to denote positive and negative, respectively.
8. It is not necessary to provide electrical connections to both the solder pads and the connector port. Either set may be used depending on application specific design requirements.
9. Refer to Application Notes AN30 and AN31 for product handling, mounting and heat sink recommendations.
10. The optical center of the LED Array is nominally defined by the mechanical center of the array to a tolerance of $\pm 0.2\text{mm}$.
11. Bridgelux maintains a flatness of 0.10mm across the mounting surface of the array.

Mechanical Dimensions

Figure 40: Drawing for Vero 29 LED Array

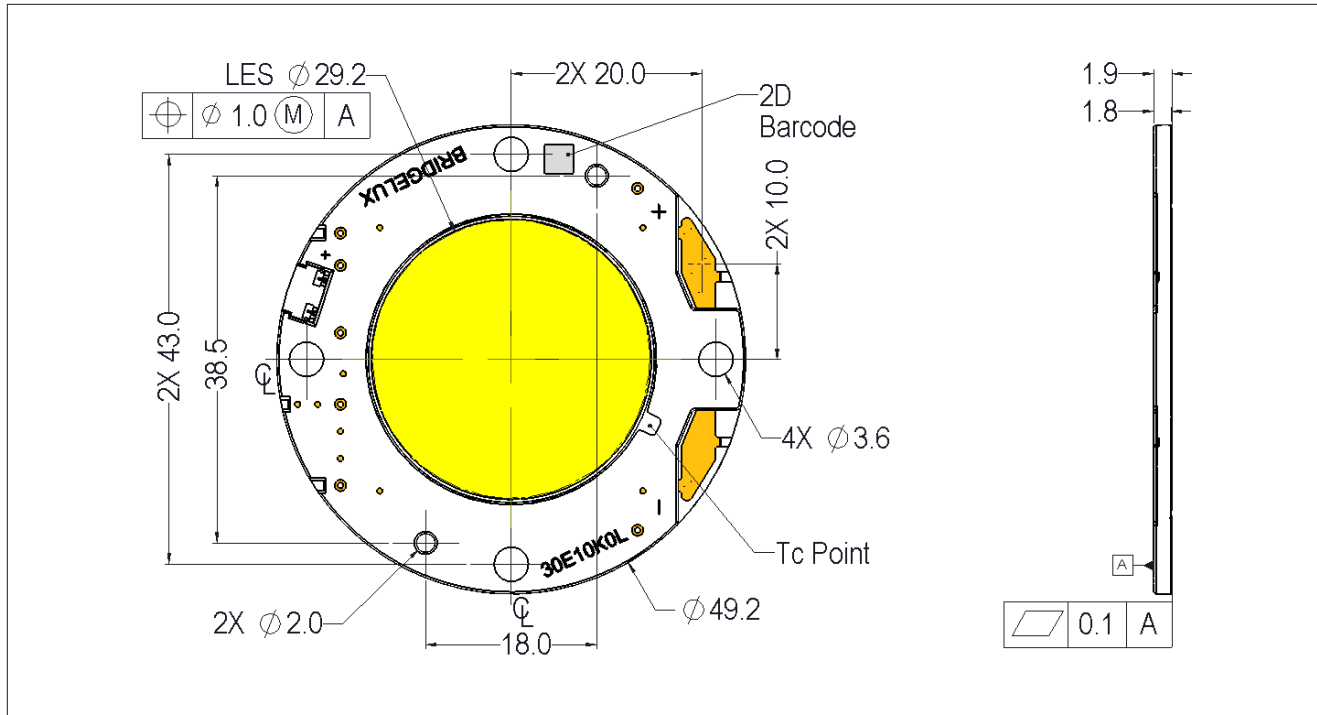

Notes for Figure 40:

1. Drawings are not to scale.
2. Drawing dimensions are in millimeters.
3. Unless otherwise specified, tolerances are ± 0.10 mm.
4. Mounting holes (4X) are for M3 screws.
5. Bridgelux recommends two tapped holes for mounting screws with 43.0 ± 0.10 mm center-to-center spacing.
6. Screws with flat shoulders (pan, dome, button, round, truss, mushroom) provide optimal torque control. Do NOT use flat, countersink, or raised head screws.
7. Solder pads and connector port are labeled "+" and "-" to denote positive and negative, respectively.
8. It is not necessary to provide electrical connections to both the solder pads and the connector port. Either set may be used depending on application specific design requirements.
9. Refer to Application Notes AN30 and AN31 for product handling, mounting and heat sink recommendations.
10. The optical center of the LED Array is nominally defined by the mechanical center of the array to a tolerance of ± 0.2 mm.
11. Bridgelux maintains a flatness of 0.10mm across the mounting surface of the array.

Color Binning Information

Figure 41: Graph of Warm and Neutral White Test Bins in xy Color Space

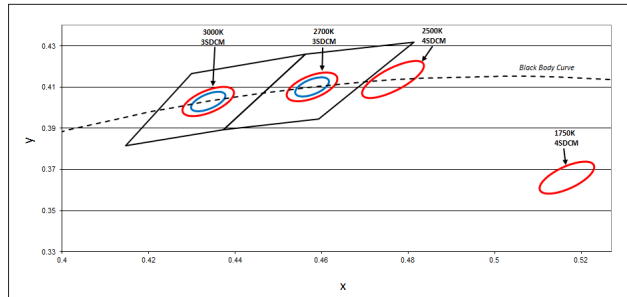

Note: Pulsed Test Conditions, $T_c = 25^\circ\text{C}$

Table 7: Warm White xy Bin Coordinates and Associated Typical CCT

Bin Code	1750K	2500K	2700K	3000K
ANSI Bin (for reference only)	-	-	(2580K - 2870K)	(2870K - 3220K)
23 (3 SDCM)	-	-	(2651K - 2794K)	(2968K - 3136K)
22 (2 SDCM)	-	-	(2674K - 2769K)	(2995K - 3107K)
Center Point (x,y)	(0.5167, 0.336)	(0.4765, 0.4137)	(0.4578, 0.4101)	(0.4338, 0.403)

Figure 42: Graph of Cool White Test Bins in xy Color Space

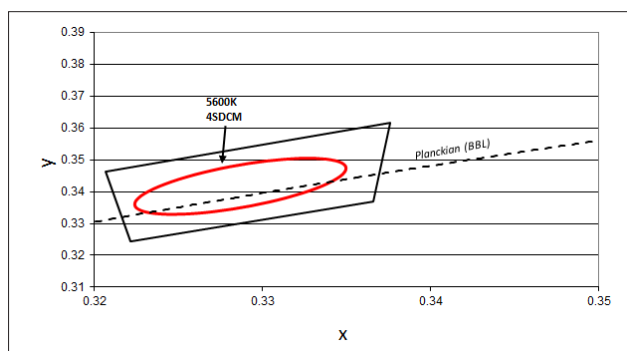

Note: Pulsed Test Conditions, $T_c = 25^\circ\text{C}$

Table 8: Cool White xy Bin Coordinates and Associated Typical CCT (product is hot targeted to $T_c = 85^\circ\text{C}$)

Bin Code	5600K
ANSI Bin (for reference only)	(5310K - 6020K)
24 (4 SDCM)	(5475K - 5830K)
Center Point (x,y)	(0.3293, 0.3423)

Packaging and Labeling

Figure 43: Drawing for Vero 10 Packaging Tray

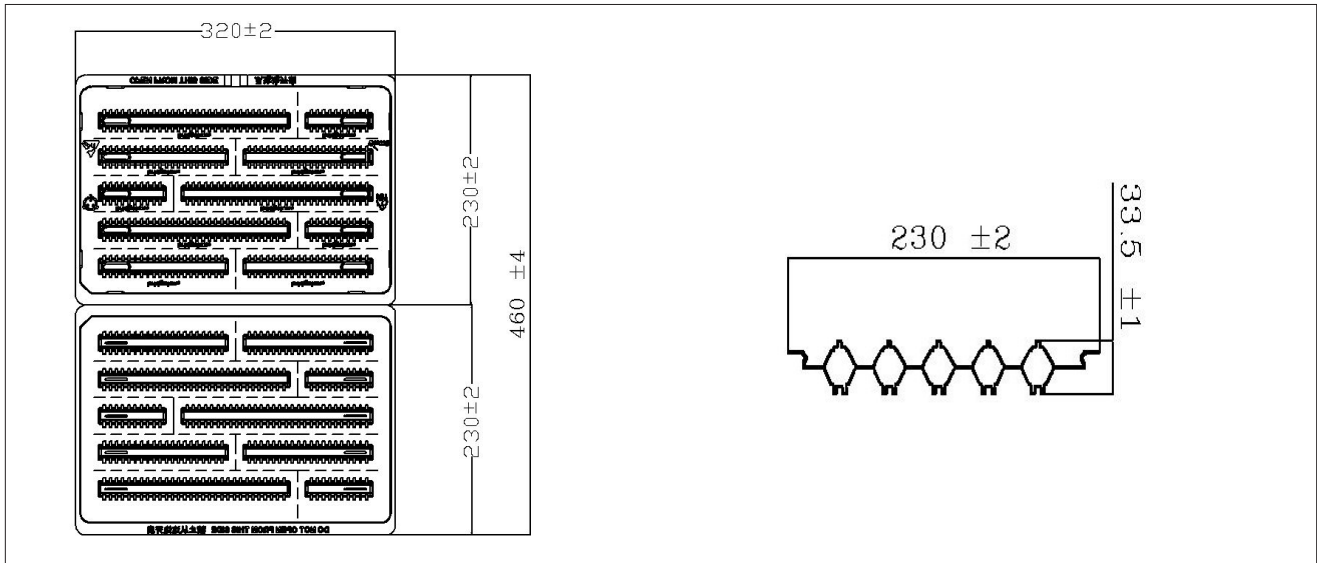

Notes for Figure 43:

1. Dimensions are in millimeters.
2. Drawing is not to scale.

Figure 44: Drawing for Vero 13 Packaging Tray

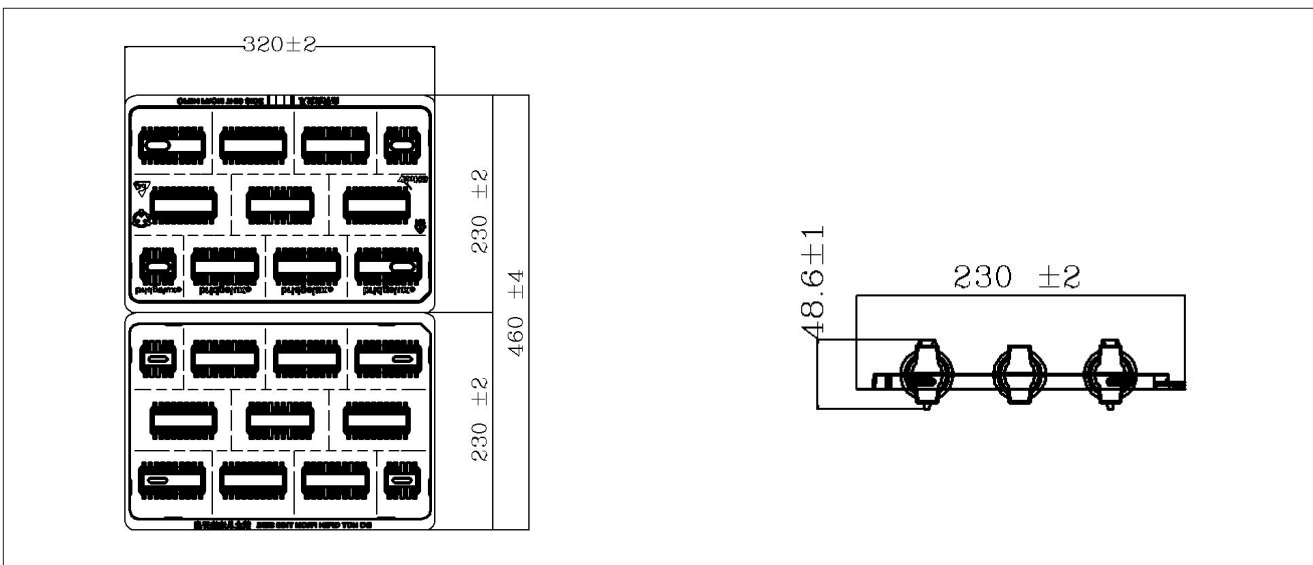

Notes for Figure 44:

1. Dimensions are in millimeters.
2. Drawing is not to scale.

Packaging and Labeling

Figure 45: Drawing for Vero 18 Packaging Tray

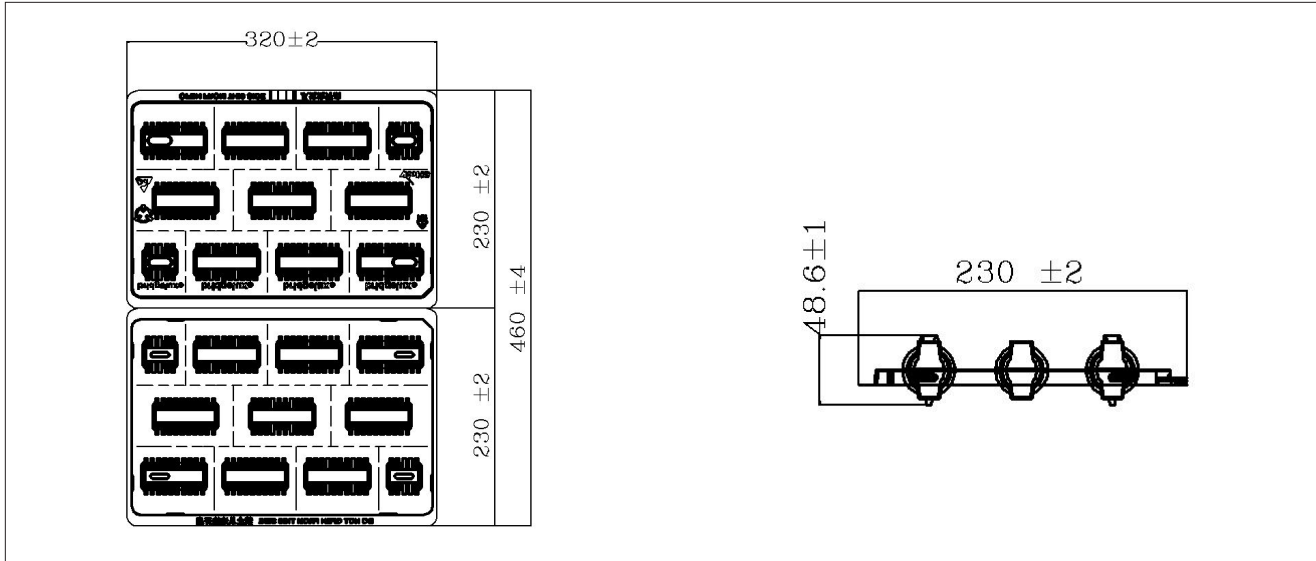

Notes for Figure 45:

1. Dimensions are in millimeters.
2. Drawings are not to scale.

Figure 46: Drawing for Vero 29 Packaging Tray

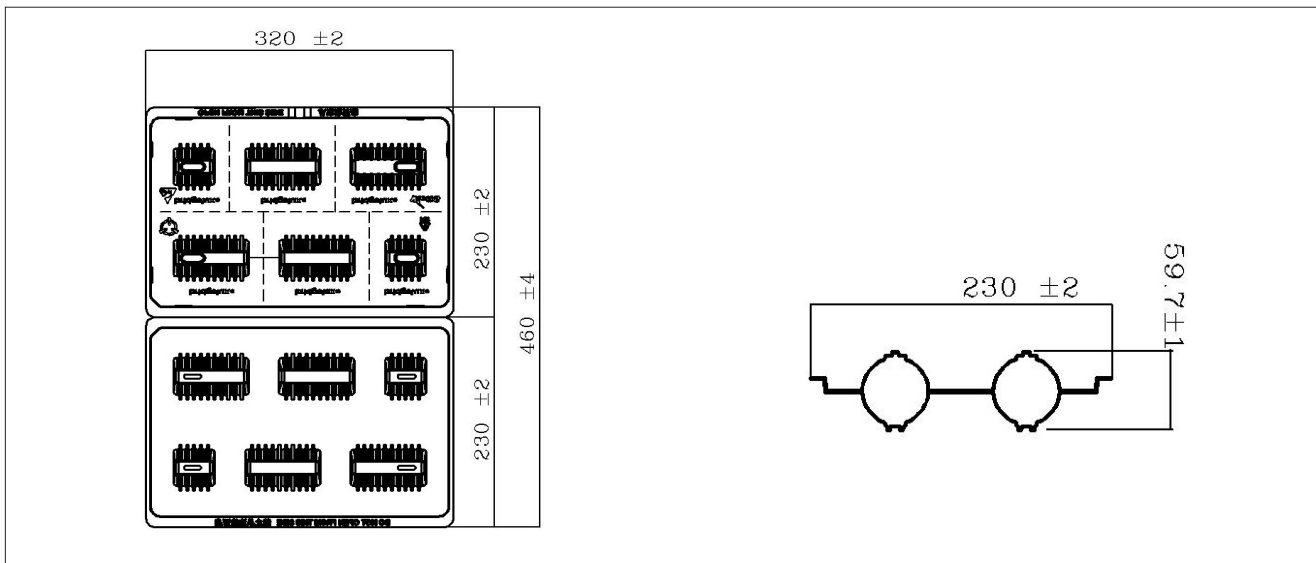

Notes for Figure 46:

1. Dimensions are in millimeters.
2. Drawings are not to scale.

Packaging and Labeling

Figure 47: Vero Series Packaging and Labeling

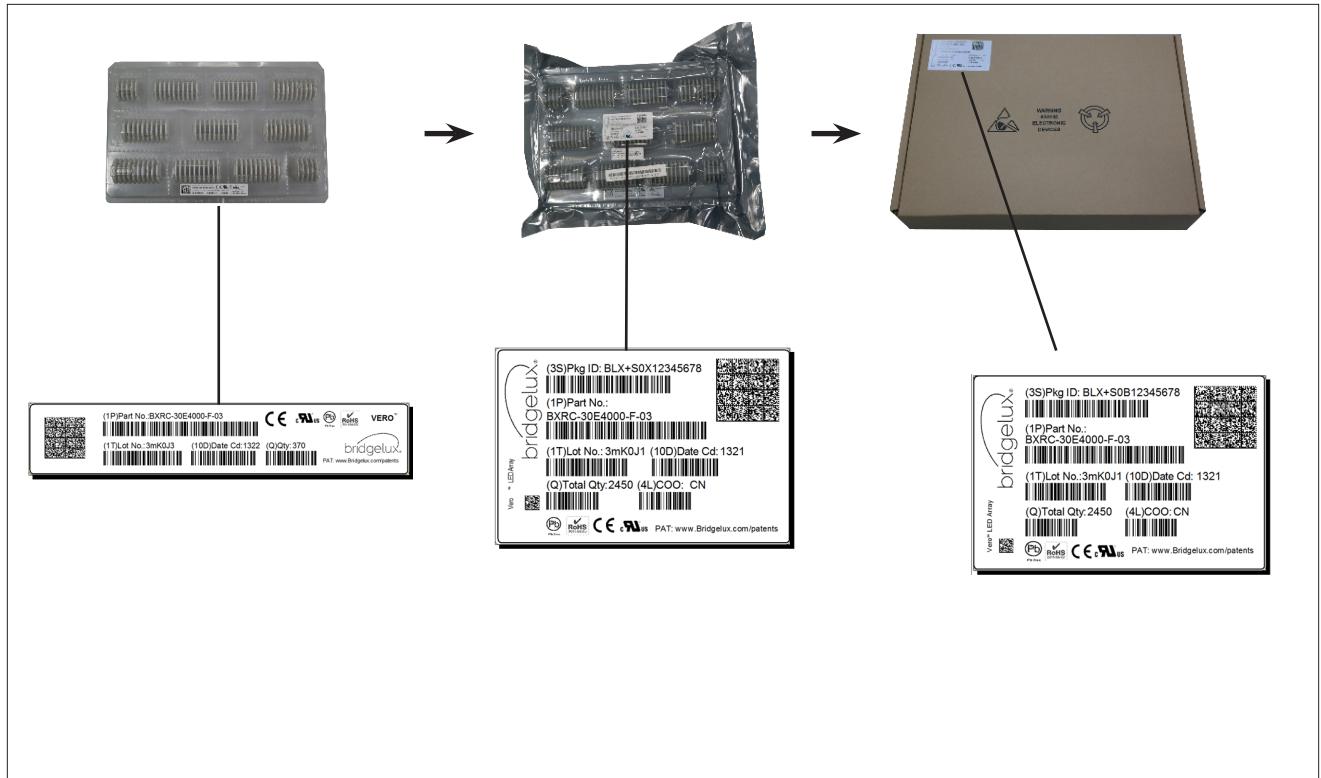

Notes for Figure 47:

1. Each tray holds for Vero 10: 200 COBs, Vero 13: 100 COBs, Vero 18: 100 COBs, Vero 29: 50 COBs.
2. Each tray is vacuum sealed in an anti-static bag and placed in its own box.
3. Each tray, bag and box is to be labeled as shown above.

Figure 48: Product Labeling

Bridgelux COB arrays have laser markings on the back side of the substrate to help with product identification. In addition to the product identification markings, Bridgelux COB arrays also contain markings for internal Bridgelux manufacturing use only. The image below shows which markings are for customer use and which ones are for Bridgelux internal use only. The Bridgelux internal manufacturing markings are subject to change without notice, however these will not impact the form, function or performance of the COB array.



Design Resources

Application Notes

Bridgelux has developed a comprehensive set of application notes and design resources to assist customers in successfully designing with the Vero product family of LED array products. For all available application notes visit www.bridgelux.com.

Optical Source Models

Optical source models and ray set files are available for all Bridgelux products. For a list of available formats, visit www.bridgelux.com.

3D CAD Models

Three dimensional CAD models depicting the product outline of all Bridgelux Vero LED arrays are available in both IGS and STEP formats. Please contact your Bridgelux sales representative for assistance.

LM80

LM80 testing is on going. Please contact your Bridgelux sales representative for more information.

Precautions

CAUTION: CHEMICAL EXPOSURE HAZARD

Exposure to some chemicals commonly used in luminaire manufacturing and assembly can cause damage to the LED array. Please consult Bridgelux Application Note AN31 for additional information.

CAUTION: EYE SAFETY

Eye safety classification for the use of Bridgelux Vero Series LED arrays is in accordance with specification IEC/TR 62778: Application of IEC 62471 for the assessment of blue light hazard to light sources and luminaires. Vero Series LED arrays are classified as Risk Group 2 (Moderate Risk) when operated at or below 2.5 times the nominal drive current. The Ethr value is 889.79 lux per IEC/TR 62778. Please use appropriate precautions. **Under many operating conditions the Vero Series LED arrays are classified as Risk Group 1, for more information please contact your Bridgelux sales representative.** It is important that employees working with LEDs are trained to use them safely.

CAUTION: RISK OF BURN

Do not touch the Vero LED array during operation. Allow the array to cool for a sufficient period of time before handling. The Vero LED array may reach elevated temperatures such that could burn skin when touched.

CAUTION

CONTACT WITH LIGHT EMITTING SURFACE (LES)

Avoid any contact with the LES. Do not touch the LES of the LED array or apply stress to the LES (yellow phosphor resin area). Contact may cause damage to the LED array.

Optics and reflectors must not be mounted in contact with the LES (yellow phosphor resin area). Optical devices may be mounted on the top surface of the plastic housing of the Vero LED array. Use the mechanical features of the LED array housing, edges and/or mounting holes to locate and secure optical devices as needed.

Disclaimers

MINOR PRODUCT CHANGE POLICY

The rigorous qualification testing on products offered by Bridgelux provides performance assurance. Slight cosmetic changes that do not affect form, fit, or function may occur as Bridgelux continues product optimization.

STANDARD TEST CONDITIONS

Unless otherwise stated, array testing is performed at the nominal drive current.

About Bridgelux: We Build Light That Transforms

At Bridgelux, we help companies, industries and people experience the power and possibility of light. Since 2002, we've designed LED solutions that are high performing, energy efficient, cost effective and easy to integrate. Our focus is on light's impact on human behavior, delivering products that create better environments, experiences and returns—both experiential and financial. And our patented technology drives new platforms for commercial and industrial luminaires.

For more information about the company, please visit
bridgelux.com
twitter.com/Bridgelux
facebook.com/Bridgelux
linkedin.com/company/Bridgelux-inc-_2
WeChat ID: BridgeluxInChina



101 Portola Avenue
Livermore, CA 94551
Tel (925) 583-8400
Fax (925) 583-8401
www.bridgelux.com

© 2016 Bridgelux, Inc. All rights reserved 2016. Product specifications are subject to change without notice. Bridgelux, the Bridgelux stylized logo design and Vero are registered trademarks, and Decor Series is a trademark of Bridgelux, Inc. All other trademarks are the property of their respective owners.

Bridgelux Gen. 7 Vero Decor Series Product Data Sheet DS94 Rev. A (07/2016)