

OMNIMATE Signal - series BL/SL 3.50 BL 3.50/02/90 SN BK BX

Weidmüller Interface GmbH & Co. KG
Klingenbergstraße 16
D-32758 Detmold
Germany
Fon: +49 5231 14-0
Fax: +49 5231 14-292083
www.weidmueller.com

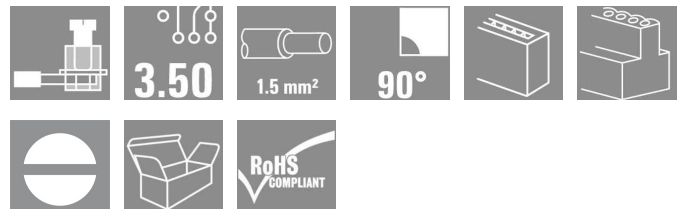

Female connectors with clamping yoke screw system for connecting conductors at 3.50 mm pitch. They include space for labelling and can be coded.

- 0.20 - 1.5 mm² (IEC) / 28 - 14 AWG (UL)
- 250 V (IEC) / 300 V (UL)
- 17 A (IEC) / 10 A (UL)

General ordering data

Type	BL 3.50/02/90 SN BK BX
Order No.	1638780000
Version	PCB plug-in connector, female plug, 3.50 mm, No. of poles: 2, 90°, Clamping yoke connection, Clamping range, rated connection, max.: 1.5 mm ² , Box
GTIN (EAN)	4008190276324
Qty.	100 pc(s).
Product data	IEC: 320 V / 12 A / 0.2 - 1.5 mm ² UL: 300 V / 8 A / AWG 28 - AWG 14
Packaging	Box

Creation date August 29, 2013 10:32:26 AM CEST

OMNIMATE Signal - series BL/SL 3.50
BL 3.50/02/90 SN BK BX

Weidmüller Interface GmbH & Co. KG
 Klingenbergstraße 16
 D-32758 Detmold
 Germany
 Fon: +49 5231 14-0
 Fax: +49 5231 14-292083
 www.weidmueller.com

Technical data
Dimensions and weights

Net weight 2.12 g

System parameters

Product family	OMNIMATE Signal - series BL/SL 3.50	Wire connection method	Clamping yoke connection
Conductor outlet direction	90°	Pitch in mm (P)	3.5 mm
Pitch in inches (P)	0.138 inch	No. of poles	2
Screwdriver blade	0.4 x 2.5	Screwdriver blade standard	DIN 5264
Tightening torque, min.	0.2 Nm	Tightening torque, max.	0.25 Nm
Clamping screw	M 2	Stripping length	6 mm
L1 in mm	3.5 mm	L1 in inches	0.138 inch
Touch-safe protection acc. to DIN VDE 0470	IP 20	Touch-safe protection acc. to DIN VDE 57 106	Safe from finger touch

Material data

Insulating material	PBT	Colour	Black
Colour chart (similar)	RAL 9011	UL 94 flammability rating	V-0
CTI	≥ 200	Contact material	Cu-Leg
Contact surface	tinned		

Connectable conductors

Clamping range, rated connection, min.	0.08 mm ²	Clamping range, rated connection, max.	1.5 mm ²
Wire connection cross section AWG, min.	AWG 14	Wire connection cross section AWG, max.	AWG 28
Solid, min. H05(07) V-U	0.2 mm ²	Solid, max. H05(07) V-U	1.5 mm ²
Flexible, min. H05(07) V-K	0.2 mm ²	Flexible, max. H05(07) V-K	1.5 mm ²
w. wire end ferrule, DIN 46228 pt 1, min.	0.2 mm ²	w. wire end ferrule, DIN 46228 pt 1, max.	1.5 mm ²
w. plastic collar ferrule, DIN 46228 pt 4, min.	0.2 mm ²	w. plastic collar ferrule, DIN 46228 pt 4, max.	1.5 mm ²
Plug gauge acc. to EN 60999 a x b; Ø	2.4 mm x 1.5 mm		

DIN IEC rating data

Rated current, min. no. of poles (Tu=20°C)	12 A	Rated current, max. no. of poles (Tu=20°C)	10 A
Rated current, number of poles (Tu=40°C), min	10 A	Rated current, number of poles (Tu=40°C), max.	8 A
Rated voltage for surge voltage class pollution degree II/2	320 V	Rated voltage for surge voltage class pollution degree III/2	160 V
Rated voltage for surge voltage class pollution degree III/3	160 V	Rated impulse voltage for surge voltage class pollution degree II/2	2.5 kV
Rated impulse voltage for surge voltage class pollution degree III/2	2.5 kV	Rated impulse voltage for surge voltage class contamination degree III/3	2.5 kV
Short-time withstand current resistance	3 x 1s with 100 A		

**OMNIMATE Signal - series BL/SL 3.50
BL 3.50/02/90 SN BK BX**

Weidmüller Interface GmbH & Co. KG
Klingenbergstraße 16
D-32758 Detmold
Germany
Fon: +49 5231 14-0
Fax: +49 5231 14-292083
www.weidmueller.com

Technical data

CSA rating data

Institute (CSA)



Rated voltage (Use group B)

300 V

Rated current (use group B)	10 A
Rated current (use group D)	10 A
Wire cross-section, AWG, max.	AWG 14

Rated voltage (use group D)	300 V
Wire cross-section, AWG, min.	AWG 28

UL 1059 rating data

Institute (UR)



Rated voltage (use group B)

300 V

Rated current (use group B)	8 A
Rated current (use group D)	8 A
Wire cross-section, AWG, max.	AWG 14

Rated voltage (use group D)	300 V
Wire cross-section, AWG, min.	AWG 28

Classifications

ETIM 3.0	EC001284	UNSPSC	30-21-18-10
eClass 5.1	27-26-07-04	eClass 6.2	27-26-07-04
eClass 7.1	27-44-04-02		

Notes

Notes

- Additional colours on request
- Gold-plated contact surfaces on request
- Rated current related to rated cross-section & min. No. of poles.
- Max. outer diameter of the conductor: 2.9 mm
- Wire end ferrule without plastic collar to DIN 46228/1
- Wire end ferrule with plastic collar to DIN 46228/4
- P on drawing = pitch
- Rated data refer only to the component itself. Clearance and creepage distances to other components are to be designed in accordance with the relevant application standards.

Approvals

Approvals



ROHS

Conform

**OMNIMATE Signal - series BL/SL 3.50
BL 3.50/02/90 SN BK BX**

Weidmüller Interface GmbH & Co. KG
Klingenbergstraße 16
D-32758 Detmold
Germany
Fon: +49 5231 14-0
Fax: +49 5231 14-292083
www.weidmueller.com

Drawings

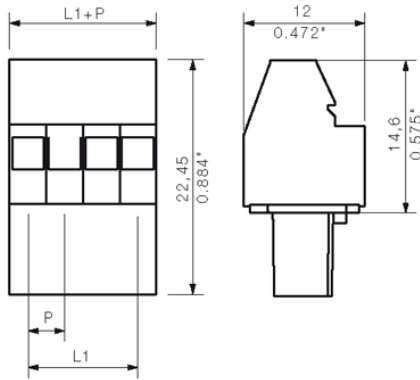

BL 3.50/./90 & /270 - SL 3.50/./90

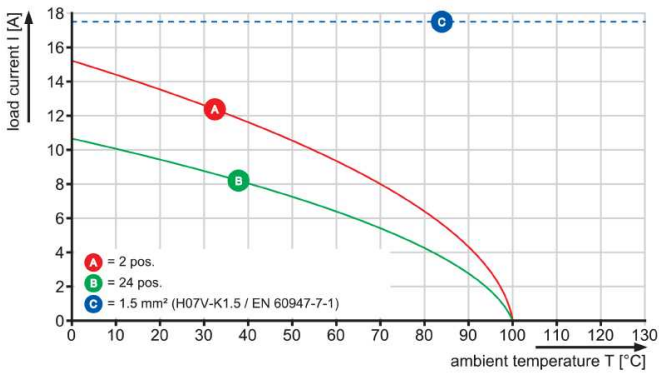

BL 3.50/./90 & /270 - SL 3.50/./90

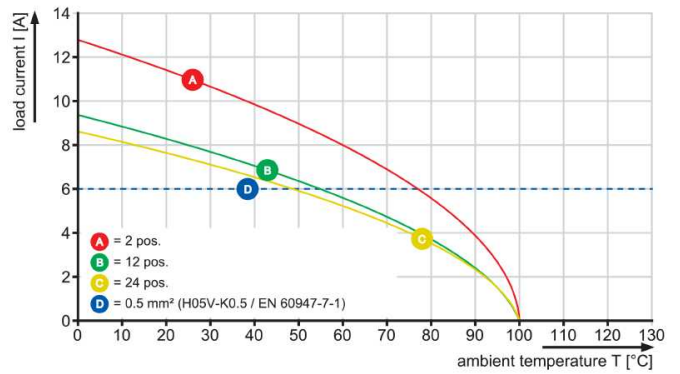

OMNIMATE Signal - series BL/SL 3.50
BL 3.50/02/90 SN BK BX

Weidmüller Interface GmbH & Co. KG
 Klingenbergstraße 16
 D-32758 Detmold
 Germany
 Fon: +49 5231 14-0
 Fax: +49 5231 14-292083
 www.weidmueller.com

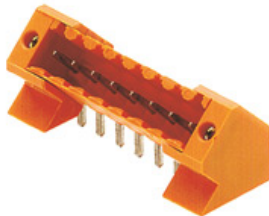
Mating connector (conditionally pluggable)
SL 3.50/135F

Male header with 3.50 mm pitch for wave soldering

- Plugging direction angled to the PCB (135°)
- Housing variant: screw flange (F)
- Packaged in cardboard box (BX)
- Male header can be coded

250 V (IEC) / 300 V (UL)
 17 A (IEC) / 10 A (UL)

General ordering data

Type	Order No.	Version	GTIN (EAN)	Qty.	Product data	Packaging
SL	1643330000	PCB plug-in connector,	4008190282097	100 pc(s).	IEC: 320 V / 15 A	Box
3.50/02/135F		male header, Flange, Solder			UL: 300 V / 10 A	
3.2SN OR BX		connection, 3.50 mm, No.				
		of poles: 2, 135°, Solder pin				
		length (l): 3.2 mm, tinned,				
		Orange, Box				

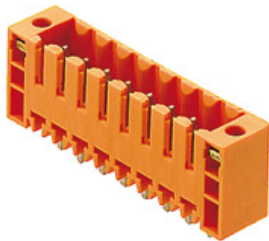
SL 3.50/180F

Male header with 3.50 mm pitch for wave soldering

- Plugging direction angled to the PCB (135°)
- Housing variant: screw flange (F)
- Packaged in cardboard box (BX)
- Male header can be coded

250 V (IEC) / 300 V (UL)
 17 A (IEC) / 10 A (UL)

General ordering data

Type	Order No.	Version	GTIN (EAN)	Qty.	Product data	Packaging
SL	1607500000	PCB plug-in connector,	4008190180317	100 pc(s).	IEC: 320 V / 17 A	Box
3.50/02/180F		male header, Flange, Solder			UL: 300 V / 10 A	
3.2SN OR BX		connection, 3.50 mm, No.				
		of poles: 2, 180°, Solder pin				
		length (l): 3.2 mm, tinned,				
		Orange, Box				

**OMNIMATE Signal - series BL/SL 3.50
BL 3.50/02/90 SN BK BX**

Weidmüller Interface GmbH & Co. KG
 Klingenbergstraße 16
 D-32758 Detmold
 Germany
 Fon: +49 5231 14-0
 Fax: +49 5231 14-292083
 www.weidmueller.com

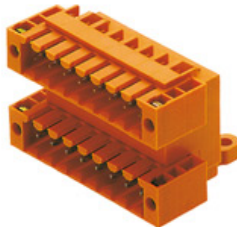
Mating connector (conditionally pluggable)
SLD 3.50/90F

Two-tier male connector for wave soldering, with 3.50 mm pitch The male connector is available in open, closed and flange versions. The male connectors provide space for labelling and can be coded. Packed in cardboard box.

- 250 V (IEC) / 300 V (UL)
- 10.5 A (IEC) / 8 A (UL)

General ordering data

Type	Order No.	Version	GTIN (EAN)	Qty.	Product data	Packaging
SLD 3.50/04/90F 3.2SN OR BX	1633810000	PCB plug-in connector, male header, Flange, Solder connection, 3.50 mm, No. of poles: 4, 90°, Solder pin length (l): 3.2 mm, tinned, Orange, Box	4008190258269	50 pc(s).	IEC: 200 V / 10.5 A UL: 300 V / 8 A	Box

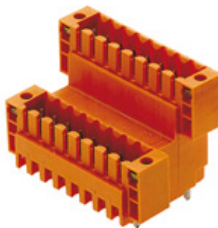
SLD 3.50V/180F

Two-tier offset male connector for wave soldering, with 3.50 mm pitch The male connector is available in closed and flange versions. The male connectors provide space for labelling and can be coded.

- 250 V (IEC) / 300 V (UL)
- 10.5 A (IEC) / 8 A (UL)

General ordering data

Type	Order No.	Version	GTIN (EAN)	Qty.	Product data	Packaging
SLD 3.50 V/04/180F 3.2 SN OR BX	1641240000	PCB plug-in connector, male header, Flange, Solder connection, 3.50 mm, No. of poles: 4, 180°, Solder pin length (l): 3.2 mm, tinned, Orange, Box	4008190279646	50 pc(s).	IEC: 200 V / 10.5 A UL: 300 V / 8 A	Box

**OMNIMATE Signal - series BL/SL 3.50
BL 3.50/02/90 SN BK BX**

Weidmüller Interface GmbH & Co. KG
Klingenbergstraße 16
D-32758 Detmold
Germany
Fon: +49 5231 14-0
Fax: +49 5231 14-292083
www.weidmueller.com

Mating connector (conditionally pluggable)
SL-SMT 3.5/180F Box

High-temperature-resistant male header, 3.50 mm pitch.

- **Plugging direction parallel (90°), straight 180° or angled (135°) to PCB**
- **Housing variants: closed side (G), screw flange (F), solder flange (LF) or snap-on solder flange (RF)**
- **Optimised for the SMT process**
- **Pin length 3.2 mm universal for all soldering methods**
- **Pin length 1.5 mm optimised for reflow soldering methods**
- **Packed either in a box (BX) or tape-on-reel (RL)**
- **Male header can be coded**

General ordering data

Type	Order No.	Version	GTIN (EAN)	Qty.	Product data	Packaging
SL-SMT 3.50/02/180F 1.5SN BK BX	1760962001	PCB plug-in connector, male header, Flange, Reflow solder connection, 3.50 mm, No. of poles: 2, 180°, Solder pin length (l): 1.5 mm, tinned, Black, Box	4032248131532	100 pc(s).	IEC: 320 V / 15 A UL: 300 V / 10 A	Box
SL-SMT 3.50/02/180F 3.2SN BK BX	1842770000	PCB plug-in connector, male header, Flange, Reflow solder connection, 3.50 mm, No. of poles: 2, 180°, Solder pin length (l): 3.2 mm, tinned, Black, Box	4032248354139	100 pc(s).	IEC: 320 V / 15 A UL: 300 V / 10 A	Box

SLD 3.50V/90F

Two-tier offset male connector for wave soldering, with 3.50 mm pitch The male connector is available in closed and flange versions. The male connectors provide space for labelling and can be coded.

- 250 V (IEC) / 300 V (UL)
- 10.5 A (IEC) / 8 A (UL)

General ordering data

Type	Order No.	Version	GTIN (EAN)	Qty.	Product data	Packaging
SLD 3.50 V/04/90F 3.2 SN OR BX	1642370000	PCB plug-in connector, male header, Flange, Solder connection, 3.50 mm, No. of poles: 4, 90°, Solder pin	4008190280895	50 pc(s).	IEC: 200 V / 10.5 A UL: 300 V / 8 A	Box

**OMNIMATE Signal - series BL/SL 3.50
BL 3.50/02/90 SN BK BX**

Weidmüller Interface GmbH & Co. KG
Klingenbergstraße 16
D-32758 Detmold
Germany
Fon: +49 5231 14-0
Fax: +49 5231 14-292083
www.weidmueller.com

Mating connector (conditionally pluggable)

length (l): 3.2 mm, tinned,
Orange, Box

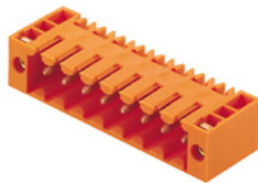
SL 3.50/90F

Male header with 3.50 mm pitch for wave soldering

- Plugging direction angled to the PCB (135°)
- Housing variant: screw flange (F)
- Packaged in cardboard box (BX)
- Male header can be coded

250 V (IEC) / 300 V (UL)
17 A (IEC) / 10 A (UL)

General ordering data

Type	Order No.	Version	GTIN (EAN)	Qty.	Product data	Packaging
SL 3.50/02/90F 3.2SN OR BX	1607040000	PCB plug-in connector, male header, Flange, Solder connection, 3.50 mm, No. of poles: 2, 90°, Solder pin length (l): 3.2 mm, tinned, Orange, Box	4008190061234	100 pc(s).	IEC: 320 V / 17 A UL: 300 V / 10 A	Box

SL-SMT 3.5/90LF Box

High-temperature-resistant male header, 3.50 mm pitch.

- **Plugging direction parallel (90°), straight 180° or angled (135°) to PCB**
- **Housing variants: closed side (G), screw flange (F), solder flange (LF) or snap-on solder flange (RF)**
- **Optimised for the SMT process**
- **Pin length 3.2 mm universal for all soldering methods**
- **Pin length 1.5 mm optimised for reflow soldering methods**
- **Packed either in a box (BX) or tape-on-reel (RL)**
- **Male header can be coded**

General ordering data

Type	Order No.	Version	GTIN (EAN)	Qty.	Product data	Packaging
SL-SMT 3.50/02/90LF 3.2SN BK BX	1841860000	PCB plug-in connector, male header, Solder flange, Reflow solder connection, 3.50 mm, No. of poles: 2, 90°, Solder pin length (l): 3.2 mm, tinned, Black, Box	4032248353217	100 pc(s).	IEC: 320 V / 15 A UL: 300 V / 10 A	Box

**OMNIMATE Signal - series BL/SL 3.50
BL 3.50/02/90 SN BK BX**

Weidmüller Interface GmbH & Co. KG
Klingenbergstraße 16
D-32758 Detmold
Germany
Fon: +49 5231 14-0
Fax: +49 5231 14-292083
www.weidmueller.com

Mating connector (conditionally pluggable)

SL-SMT 3.50/02/90LF 1.5SN BK BX	1804940000	PCB plug-in connector, male header, Solder flange, Reflow solder connection, 3.50 mm, No. of poles: 2, 90°, Solder pin length (l): 1.5 mm, tinned, Black, Box	4032248268849 100 pc(s).	IEC: 320 V / 15 A UL: 300 V / 10 A	Box
---------------------------------------	----------------------------	--	--------------------------	---------------------------------------	-----

SL-SMT 3.5/90F Box



High-temperature-resistant male header, 3.50 mm pitch.

- **Plugging direction parallel (90°), straight 180° or angled (135°) to PCB**
- **Housing variants: closed side (G), screw flange (F), solder flange (LF) or snap-on solder flange (RF)**
- **Optimised for the SMT process**
- **Pin length 3.2 mm universal for all soldering methods**
- **Pin length 1.5 mm optimised for reflow soldering methods**
- **Packed either in a box (BX) or tape-on-reel (RL)**
- **Male header can be coded**

General ordering data

Type	Order No.	Version	GTIN (EAN)	Qty.	Product data	Packaging
SL-SMT 3.50/02/90F 3.2SN BK BX	1842080000	PCB plug-in connector, male header, Flange, Reflow solder connection, 3.50 mm, No. of poles: 2, 90°, Solder pin length (l): 3.2 mm, tinned, Black, Box	4032248353439	100 pc(s).	IEC: 320 V / 15 A UL: 300 V / 10 A	Box

**OMNIMATE Signal - series BL/SL 3.50
BL 3.50/02/90 SN BK BX**

Weidmüller Interface GmbH & Co. KG
 Klingenbergstraße 16
 D-32758 Detmold
 Germany
 Fon: +49 5231 14-0
 Fax: +49 5231 14-292083
 www.weidmueller.com

Mating connector (conditionally pluggable)
SL-SMT 3.5/180G Box

High-temperature-resistant male header, 3.50 mm pitch.

- **Plugging direction parallel (90°), straight 180° or angled (135°) to PCB**
- **Housing variants: closed side (G), screw flange (F), solder flange (LF) or snap-on solder flange (RF)**
- **Optimised for the SMT process**
- **Pin length 3.2 mm universal for all soldering methods**
- **Pin length 1.5 mm optimised for reflow soldering methods**
- **Packed either in a box (BX) or tape-on-reel (RL)**
- **Male header can be coded**

General ordering data

Type	Order No.	Version	GTIN (EAN)	Qty.	Product data	Packaging
SL-SMT 3.50/02/180G 3.2SN BK BX	1842320000	PCB plug-in connector, male header, closed side, Reflow solder connection, 3.50 mm, No. of poles: 2, 180°, Solder pin length (l): 3.2 mm, tinned, Black, Box	4032248353668	100 pc(s).	IEC: 320 V / 15 A UL: 300 V / 10 A	Box
SL-SMT 3.50/02/180G 1.5SN BK BX	1752982001	PCB plug-in connector, male header, closed side, Reflow solder connection, 3.50 mm, No. of poles: 2, 180°, Solder pin length (l): 1.5 mm, tinned, Black, Box	4032248130887	100 pc(s).	IEC: 320 V / 15 A UL: 300 V / 10 A	Box

OMNIMATE Signal - series BL/SL 3.50 BL 3.50/02/90 SN BK BX

Weidmüller Interface GmbH & Co. KG
Klingenbergstraße 16
D-32758 Detmold
Germany
Fon: +49 5231 14-0
Fax: +49 5231 14-292083
www.weidmueller.com

Mating connector (conditionally pluggable)

SL-SMT 3.5/90LF Tape



High-temperature-resistant male header, 3.50 mm pitch.

- **Plugging direction parallel (90°), straight 180° or angled (135°) to PCB**
- **Housing variants: closed side (G), screw flange (F), solder flange (LF) or snap-on solder flange (RF)**
- **Optimised for the SMT process**
- **Pin length 3.2 mm universal for all soldering methods**
- **Pin length 1.5 mm optimised for reflow soldering methods**
- **Packed either in a box (BX) or tape-on-reel (RL)**
- **Male header can be coded**

General ordering data

Type	Order No.	Version	GTIN (EAN)	Qty.	Product data	Packaging
SL-SMT	1805310000	PCB plug-in connector,	4032248269761	385 pc(s).	IEC: 320 V / 15 A	Tape
3.50/02/90LF		male header, Solder flange,			UL: 300 V / 10 A	
1.5SN BK RL		Reflow solder connection,				
		3.50 mm, No. of poles: 2,				
		90°, Solder pin length (l):				
		1.5 mm, tinned, Black, Tape				

SL-SMT 3.5/180LF Box



High-temperature-resistant male header, 3.50 mm pitch.

- **Plugging direction parallel (90°), straight 180° or angled (135°) to PCB**
- **Housing variants: closed side (G), screw flange (F), solder flange (LF) or snap-on solder flange (RF)**
- **Optimised for the SMT process**
- **Pin length 3.2 mm universal for all soldering methods**
- **Pin length 1.5 mm optimised for reflow soldering methods**
- **Packed either in a box (BX) or tape-on-reel (RL)**
- **Male header can be coded**

General ordering data

Type	Order No.	Version	GTIN (EAN)	Qty.	Product data	Packaging
SL-SMT	1804700000	PCB plug-in connector,	4032248268511	100 pc(s).	IEC: 320 V / 15 A	Box
3.50/02/180LF		male header, Solder flange,			UL: 300 V / 10 A	
1.5SN BK BX		Reflow solder connection,				
		3.50 mm, No. of poles: 2,				

Creation date August 29, 2013 10:32:26 AM CEST

**OMNIMATE Signal - series BL/SL 3.50
BL 3.50/02/90 SN BK BX**

Weidmüller Interface GmbH & Co. KG
 Klingenbergstraße 16
 D-32758 Detmold
 Germany
 Fon: +49 5231 14-0
 Fax: +49 5231 14-292083
 www.weidmueller.com

Mating connector (conditionally pluggable)

		180°, Solder pin length (l): 1.5 mm, tinned, Black, Box		
SL-SMT	1842540000	PCB plug-in connector,	4032248353903 100 pc(s).	IEC: 320 V / 15 A UL: 300 V / 10 A
3.50/02/180LF		male header, Solder flange,		
3.2SN BK BX		Reflow solder connection, 3.50 mm, No. of poles: 2, 180°, Solder pin length (l): 3.2 mm, tinned, Black, Box		Box

SL-SMT 3.5/180LF Tape

High-temperature-resistant male header, 3.50 mm pitch.

- **Plugging direction parallel (90°), straight 180° or angled (135°) to PCB**
- **Housing variants: closed side (G), screw flange (F), solder flange (LF) or snap-on solder flange (RF)**
- **Optimised for the SMT process**
- **Pin length 3.2 mm universal for all soldering methods**
- **Pin length 1.5 mm optimised for reflow soldering methods**
- **Packed either in a box (BX) or tape-on-reel (RL)**
- **Male header can be coded**

General ordering data

Type	Order No.	Version	GTIN (EAN)	Qty.	Product data	Packaging
SL-SMT	1805210000	PCB plug-in connector,	4032248269099 265 pc(s).		IEC: 320 V / 15 A UL: 300 V / 10 A	Tape
3.50/02/180LF		male header, Solder flange,				
1.5SN BK RL		Reflow solder connection, 3.50 mm, No. of poles: 2, 180°, Solder pin length (l): 1.5 mm, tinned, Black, Tape				

**OMNIMATE Signal - series BL/SL 3.50
BL 3.50/02/90 SN BK BX**

Weidmüller Interface GmbH & Co. KG
Klingenbergstraße 16
D-32758 Detmold
Germany
Fon: +49 5231 14-0
Fax: +49 5231 14-292083
www.weidmueller.com

Mating connector (fully pluggable)**SL-THR 3.5/135F**

High-temperature-resistant male header, 3.50 mm pitch.

- **Plugging direction parallel (90°), straight 180° or angled (135°) to PCB**
- **Housing variants: closed side (G), screw flange (F), solder flange (LF) or snap-on solder flange (RF)**
- **Optimised for the SMT process**
- **Pin length 3.2 mm universal for all soldering methods**
- **Pin length 1.5 mm optimised for reflow soldering methods**
- **Packed either in a box (BX) or tape-on-reel (RL)**
- **Male header can be coded**

General ordering data

Type	Order No.	Version	GTIN (EAN)	Qty.	Product data	Packaging
SL-SMT	1003510000	PCB plug-in connector, male	4032248700141	100 pc(s).	IEC: 320 V / 15 A UL: 300 V / 10 A	Box
3.50/02/135F		header, Flange, Reflow solder connection, 3.50 mm, No. of poles: 2, 135°, Solder pin length (l): 3.2 mm, tinned, Black, Box				

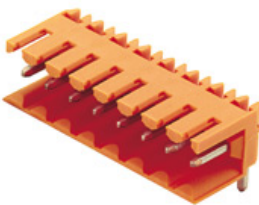
SL 3.50/90

Male header with 3.50 mm pitch for wave soldering

- **Plugging direction angled to the PCB (135°)**
- **Housing variant: screw flange (F)**
- **Packaged in cardboard box (BX)**
- **Male header can be coded**

250 V (IEC) / 300 V (UL)
17 A (IEC) / 10 A (UL)

General ordering data

Type	Order No.	Version	GTIN (EAN)	Qty.	Product data	Packaging
SL	1597210000	PCB plug-in connector, male	4008190175320	100 pc(s).	IEC: 320 V / 17 A UL: 300 V / 10 A	Box
3.50/02/90		header, open side, Solder connection, 3.50 mm, No. of poles: 2, 90°, Solder pin length (l): 3.2 mm, tinned, Orange, Box				

OMNIMATE Signal - series BL/SL 3.50 BL 3.50/02/90 SN BK BX

Weidmüller Interface GmbH & Co. KG
Klingenbergstraße 16
D-32758 Detmold
Germany
Fon: +49 5231 14-0
Fax: +49 5231 14-292083
www.weidmueller.com

Mating connector (fully pluggable)

SL-SMT 3.5/90G Tape



High-temperature-resistant male header, 3.50 mm pitch.

- **Plugging direction parallel (90°), straight 180° or angled (135°) to PCB**
- **Housing variants: closed side (G), screw flange (F), solder flange (LF) or snap-on solder flange (RF)**
- **Optimised for the SMT process**
- **Pin length 3.2 mm universal for all soldering methods**
- **Pin length 1.5 mm optimised for reflow soldering methods**
- **Packed either in a box (BX) or tape-on-reel (RL)**
- **Male header can be coded**

General ordering data

Type	Order No.	Version	GTIN (EAN)	Qty.	Product data	Packaging
SL-SMT	1761544002	PCB plug-in connector, male	4032248193325	385 pc(s).	IEC: 320 V / 15 A	Tape
3.50/02/90G		header, closed side, Reflow			UL: 300 V / 10 A	
1.5SN BK RL		solder connection, 3.50 mm, No. of poles: 2, 90°, Solder pin length (l): 1.5 mm, tinned, Black, Tape				

SLD 3.50/90

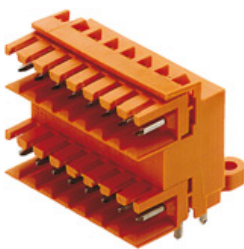

Two-tier male connector for wave soldering, with 3.50 mm pitch. The male connector is available in open, closed and flange versions. The male connectors provide space for labelling and can be coded. Packed in cardboard box.

- 250 V (IEC) / 300 V (UL)
- 10.5 A (IEC) / 8 A (UL)

General ordering data

Type	Order No.	Version	GTIN (EAN)	Qty.	Product data	Packaging
SLD	1633350000	PCB plug-in connector, male	4008190257804	50 pc(s).	IEC: 200 V / 10.5 A	Box
3.50/04/90		header, open side, Solder			UL: 300 V / 8 A	
3.2SN OR BX		connection, 3.50 mm, No. of poles: 4, 90°, Solder pin length (l): 3.2 mm, tinned, Orange, Box				

**OMNIMATE Signal - series BL/SL 3.50
BL 3.50/02/90 SN BK BX**

Weidmüller Interface GmbH & Co. KG
Klingenbergstraße 16
D-32758 Detmold
Germany
Fon: +49 5231 14-0
Fax: +49 5231 14-292083
www.weidmueller.com

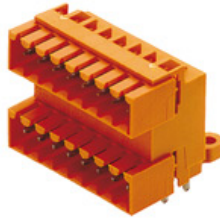
Mating connector (fully pluggable)
SLD 3.50/90G

Two-tier male connector for wave soldering, with 3.50 mm pitch. The male connector is available in open, closed and flange versions. The male connectors provide space for labelling and can be coded. Packed in cardboard box.

- 250 V (IEC) / 300 V (UL)
- 10.5 A (IEC) / 8 A (UL)

General ordering data

Type	Order No.	Version	GTIN (EAN)	Qty.	Product data	Packaging
SLD	1633580000	PCB plug-in connector, male	4008190258030	50 pc(s).	IEC: 200 V / 10.5 A UL: 300 V / 8 A	Box
3.50/04/90G		header, closed side, Solder connection, 3.50 mm, No. of poles: 4, 90°, Solder pin length (l): 3.2 mm, tinned,				
3.2SN OR BX		Orange, Box				

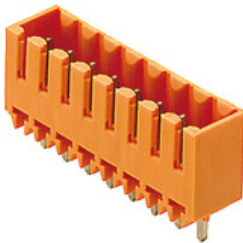
SL 3.50/180G

Male header with 3.50 mm pitch for wave soldering

- Plugging direction angled to the PCB (135°)
- Housing variant: screw flange (F)
- Packaged in cardboard box (BX)
- Male header can be coded

250 V (IEC) / 300 V (UL)
17 A (IEC) / 10 A (UL)

General ordering data

Type	Order No.	Version	GTIN (EAN)	Qty.	Product data	Packaging
SL	1604470000	PCB plug-in connector, male	4008190137526	100 pc(s).	IEC: 320 V / 17 A UL: 300 V / 10 A	Box
3.50/02/180G		header, closed side, Solder connection, 3.50 mm, No. of poles: 2, 180°, Solder pin length (l): 3.2 mm, tinned,				
3.2SN OR BX		Orange, Box				

**OMNIMATE Signal - series BL/SL 3.50
BL 3.50/02/90 SN BK BX**

Weidmüller Interface GmbH & Co. KG
Klingenbergstraße 16
D-32758 Detmold
Germany
Fon: +49 5231 14-0
Fax: +49 5231 14-292083
www.weidmueller.com

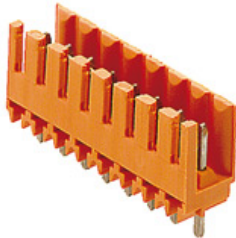
Mating connector (fully pluggable)
SL 3.50/180

Male header with 3.50 mm pitch for wave soldering

- Plugging direction angled to the PCB (135°)
- Housing variant: screw flange (F)
- Packaged in cardboard box (BX)
- Male header can be coded

250 V (IEC) / 300 V (UL)
17 A (IEC) / 10 A (UL)

General ordering data

Type	Order No.	Version	GTIN (EAN)	Qty.	Product data	Packaging
SL	1604770000	PCB plug-in connector, male	4008190054182	100 pc(s).	IEC: 320 V / 17 A	Box
3.50/02/180		header, open side, Solder connection, 3.50 mm, No. of poles: 2, 180°, Solder pin length (l): 3.2 mm, tinned, Orange, Box			UL: 300 V / 10 A	

SL-SMT 3.5/90G Box

High-temperature-resistant male header, 3.50 mm pitch.

- **Plugging direction parallel (90°), straight 180° or angled (135°) to PCB**
- **Housing variants: closed side (G), screw flange (F), solder flange (LF) or snap-on solder flange (RF)**
- **Optimised for the SMT process**
- **Pin length 3.2 mm universal for all soldering methods**
- **Pin length 1.5 mm optimised for reflow soldering methods**
- **Packed either in a box (BX) or tape-on-reel (RL)**
- **Male header can be coded**

General ordering data

Type	Order No.	Version	GTIN (EAN)	Qty.	Product data	Packaging
SL-SMT	1761542001	PCB plug-in connector, male	4032248132034	100 pc(s).	IEC: 320 V / 15 A	Box
3.50/02/90G		header, closed side, Reflow solder connection, 3.50 mm, No. of poles: 2, 90°, Solder pin length (l): 1.5 mm, tinned, Black, Box			UL: 300 V / 10 A	
1.5SN BK BX						
SL-SMT	1841630000	PCB plug-in connector, male	4032248352784	100 pc(s).	IEC: 320 V / 15 A	Box
3.50/02/90G		header, closed side, Reflow solder connection, 3.50 mm, No. of poles: 2, 90°			UL: 300 V / 10 A	
3.2SN BK BX						

**OMNIMATE Signal - series BL/SL 3.50
BL 3.50/02/90 SN BK BX**

Weidmüller Interface GmbH & Co. KG
Klingenbergstraße 16
D-32758 Detmold
Germany
Fon: +49 5231 14-0
Fax: +49 5231 14-292083
www.weidmueller.com

Mating connector (fully pluggable)

Solder pin length (l): 3.2
mm, tinned, Black, Box

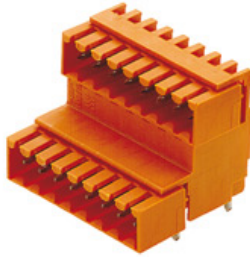
SLD 3.50V/90G

Two-tier offset male connector for wave soldering, with 3.50 mm pitch The male connector is available in closed and flange versions. The male connectors provide space for labelling and can be coded.

- 250 V (IEC) / 300 V (UL)
- 10.5 A (IEC) / 8 A (UL)

General ordering data

Type	Order No.	Version	GTIN (EAN)	Qty.	Product data	Packaging
SLD 3.50 V/04/90G 3.2 SN OR BX	1642240000	PCB plug-in connector, male header, closed side, Solder connection, 3.50 mm, No. of poles: 4, 90°, Solder pin length (l): 3.2 mm, tinned, Orange, Box	4008190280758	50 pc(s).	IEC: 200 V / 10.5 A UL: 300 V / 8 A	Box

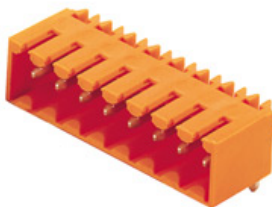
SL 3.50/90G

Male header with 3.50 mm pitch for wave soldering

- Plugging direction angled to the PCB (135°)
- Housing variant: screw flange (F)
- Packaged in cardboard box (BX)
- Male header can be coded

250 V (IEC) / 300 V (UL)
17 A (IEC) / 10 A (UL)

General ordering data

Type	Order No.	Version	GTIN (EAN)	Qty.	Product data	Packaging
SL 3.50/02/90G 3.2SN OR BX	1605070000	PCB plug-in connector, male header, closed side, Solder connection, 3.50 mm, No. of poles: 2, 90°, Solder pin length (l): 3.2 mm, tinned, Orange, Box	4008190085100	100 pc(s).	IEC: 320 V / 17 A UL: 300 V / 10 A	Box

**OMNIMATE Signal - series BL/SL 3.50
BL 3.50/02/90 SN BK BX**

Weidmüller Interface GmbH & Co. KG
Klingenbergstraße 16
D-32758 Detmold
Germany
Fon: +49 5231 14-0
Fax: +49 5231 14-292083
www.weidmuller.com

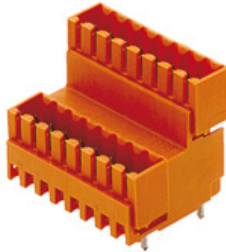
Mating connector (fully pluggable)
SLD 3.50V/180G

Two-tier offset male connector for wave soldering, with 3.50 mm pitch. The male connector is available in closed and flange versions. The male connectors provide space for labelling and can be coded.

- 250 V (IEC) / 300 V (UL)
- 10.5 A (IEC) / 8 A (UL)

General ordering data

Type	Order No.	Version	GTIN (EAN)	Qty.	Product data	Packaging
SLD 3.5 V/4/180G 3.2OR	1641110000	PCB plug-in connector, male header, closed side, Solder connection, 3.50 mm, No. of poles: 4, 180°, Solder pin length (l): 3.2 mm, tinned, Orange, Box	400819027951650	50 pc(s).	IEC: 200 V / 10.5 A UL: 300 V / 8 A	Box

SL-SMT 3.5/180G Tape

High-temperature-resistant male header, 3.50 mm pitch.

- **Plugging direction parallel (90°), straight 180° or angled (135°) to PCB**
- **Housing variants: closed side (G), screw flange (F), solder flange (LF) or snap-on solder flange (RF)**
- **Optimised for the SMT process**
- **Pin length 3.2 mm universal for all soldering methods**
- **Pin length 1.5 mm optimised for reflow soldering methods**
- **Packed either in a box (BX) or tape-on-reel (RL)**
- **Male header can be coded**

General ordering data

Type	Order No.	Version	GTIN (EAN)	Qty.	Product data	Packaging
SL-SMT 3.50/02/180G 1.5SN BK RL	1752984002	PCB plug-in connector, male header, closed side, Reflow solder connection, 3.50 mm, No. of poles: 2, 180°, Solder pin length (l): 1.5 mm, tinned, Black, Tape	4032248193097	265 pc(s).	IEC: 320 V / 15 A UL: 300 V / 10 A	Tape

