

Analog Devices Welcomes Hittite Microwave Corporation

NO CONTENT ON THE ATTACHED DOCUMENT HAS CHANGED



THIS PAGE INTENTIONALLY LEFT BLANK



Typical Applications

The HMC601LP4(E) is ideal for IF and RF applications in:

- Cellular/PCS/3G
- WiMAX, WiBro & Fixed Wireless
- Power Monitoring & Control Circuitry
- Receiver Signal Strength Indication (RSSI)
- Automatic Gain & Power Control Circuits

Features

- Wide Dynamic Range: up to 75 dB
- Fast Pulse Response: 15/34ns (Rise/Fall Time)
- Flexible Supply Voltage: +2.7V to +5.5V
- Power-Down Mode
- Excellent Stability over Temperature
- Compact 4x4mm Leadless SMT Package

Functional Diagram

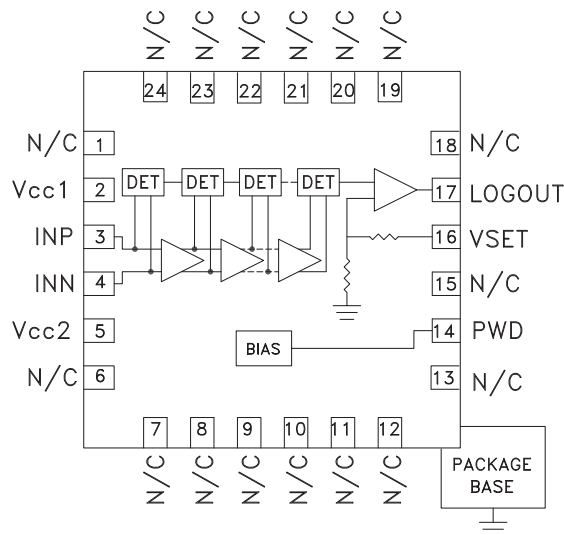

General Description

The HMC601LP4(E) Logarithmic Detector/Controller converts RF signals at its input, to a proportional DC voltage at its output. The HMC601LP4(E) employ a successive compression topology which delivers extremely high dynamic range and conversion accuracy over a wide input frequency range. As the input power is increased, successive amplifiers move into saturation one by one creating an accurate approximation of the logarithm function. The output of a series of square law detectors is summed, converted into voltage domain and buffered to drive the LOGOUT output. For detection mode, the LOGOUT pin is shorted to the VSET input, and will provide a nominal logarithmic slope of 19mV/dB and an intercept of -100dBm. The HMC601LP4(E) can also be used in the controller mode where an external voltage is applied to the VSET pin, to create an AGC or APC feedback loop. The HMC601LP4(E) provides a 15/34ns (rise/fall time) response time enabling RF burst detection to a pulse rate beyond 20 MHz.

Electrical Specifications, $T_A = +25C$, $PWD = 0V$, V_{cc1} , $V_{cc2} = +3.3V$ [1]

| Parameter | Typ. | Typ. | Typ. | Typ. | Typ. | Typ. | Typ. | Typ. | Units |
|---|------|------|------|------|-------|-------|------|------|------------------|
| Input Frequency | 50 | 100 | 500 | 900 | 1900 | 2500 | 3500 | 4000 | MHz |
| ± 3 dB Dynamic Range | 74 | 74 | 74 | 74 | 70 | 68 | 54 | 52 | dB |
| ± 3 dB Dynamic Range Center | -31 | -31 | -31 | -31 | -31.5 | -31.5 | -27 | -23 | dBm |
| ± 1 dB Dynamic Range | 68 | 68 | 69 | 69 | 67 | 65 | 47 | 46 | dB |
| Output Slope | 19.5 | 19.4 | 19.2 | 19.1 | 19.0 | 19.4 | 20.9 | 19.6 | mV/dB |
| Output Intercept | -99 | -99 | -100 | -100 | -98 | -96 | -85 | -79 | dBm |
| Temperature Sensitivity @ -10 dBm Input [2] | -4.2 | -3.8 | -3.5 | -2.4 | -0.8 | -0.8 | -4.4 | -3.5 | mdB/ $^{\circ}C$ |

[1] Detector mode measurements; LOGOUT (Pin 17) is shorted to VSET (Pin 16).

[2] Measured from $T_A = -40C$ to $T_A = +85C$

| Parameter | Conditions | Min. | Typ. | Max. | Units |
|-------------------------|--|------|------|------|------------|
| RF Input (INP) | | | | | |
| Return Loss | F = 10 - 4000 MHz, $Z_o = 50\Omega$, See plot | | 10 | | dB |
| LOGOUT Interface | | | | | |
| Open Loop Impedance | (Simulated) | | 12 | | k Ω |

For price, delivery, and to place orders, please contact Hittite Microwave Corporation:
 20 Alpha Road, Chelmsford, MA 01824 Phone: 978-250-3343 Fax: 978-250-3373
 Order On-line at www.hittite.com



75 dB, FAST SETTLING, LOGARITHMIC DETECTOR / CONTROLLER 10 - 4000 MHz

Electrical Specifications, (continued)

| Parameter | Conditions | Min. | Typ. | Max. | Units |
|---|--|-----------|------------|-----------|------------|
| Current Drive (Source) | | | 0.55 | | mA |
| Current Drive (Sink) | For 1% change in the output voltage | | 4.8 | | mA |
| Output Voltage Range | | 0 | | Vcc -0.13 | V |
| Small Signal Response Time (10% to 90%) | Pin = -60 to -57 dBm | | 8 | | ns |
| Large Signal Response Time (± 0.5 dB Settling) | Pin = No Signal to 0 dBm | | 50 | | ns |
| Output Rise Time | From 0% to 90% | | 15 | | ns |
| Ripple | Fin = 100 MHz | | <4 | | mVpp |
| VSET Interface | | | | | |
| Input Impedance | | | 30 | | k Ω |
| Input Voltage Range | | | 0.6 to 1.9 | | V |
| Low Frequency Gain | VSET to LOGOUT | | 75 | | dB |
| Open Loop Corner Frequency | | | 4.4 | | kHz |
| Power Down (PWD) Interface | | | | | |
| Voltage Range for Normal Mode | | 0 | | 0.2 x Vcc | V |
| Voltage Range for Shutdown Mode | | 0.8 x Vcc | | Vcc | V |
| Threshold Voltage | | | Vcc/2 | | V |
| Power-up Response Time | 50% PWD to ± 0.5 dB Settling of LOGOUT | | 19.9 | | μ s |
| Power-Down Response Time | 50% PWD to 10% Icc | | 2.2 | | μ s |
| Power Supply (Vcc1, Vcc2) | | | | | |
| Operating Voltage Range | | 2.7 | | 5.5 | V |
| Supply Current in Normal Mode | Vcc = +3.3V, PWD = 0V | | 30 | 36 | mA |
| Supply Current in Power Down Mode | Vcc = +3.3V, PWD = Vcc | | 1 | | mA |

Test Conditions

| Parameter | Condition |
|----------------|-------------|
| Vcc1, Vcc2 | +3.3V |
| Input Zo | 50 Ω |
| T _A | +25C |
| Fin | 900 MHz |

INN Port connected to ground through a 1000pF capacitor

LOGOUT Voltage & Error vs. Input Power, Fin = 10 MHz

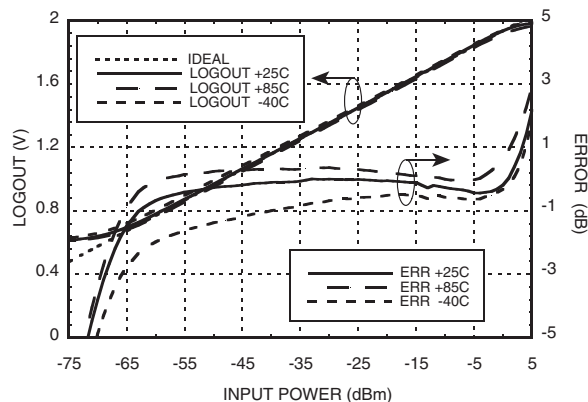

LOGOUT Voltage & Error vs. Input Power, Fin = 50 MHz

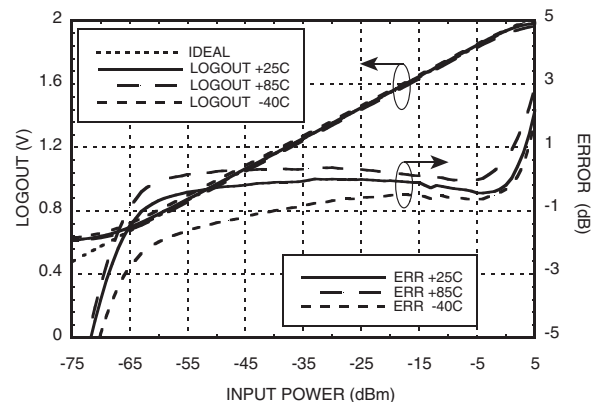

Unless otherwise noted: Vcc1, Vcc2 = +3.3V, T_A = +25C

For price, delivery, and to place orders, please contact Hittite Microwave Corporation:
 20 Alpha Road, Chelmsford, MA 01824 Phone: 978-250-3343 Fax: 978-250-3373
 Order On-line at www.hittite.com



LOGOUT Voltage & Error vs. Input Power, $f_{in} = 100$ MHz

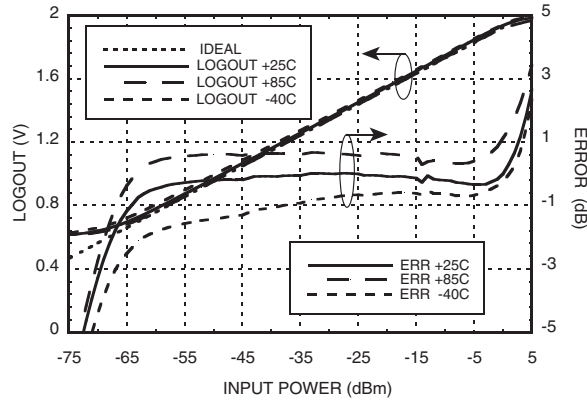

LOGOUT Voltage & Error vs. Input Power, $f_{in} = 500$ MHz

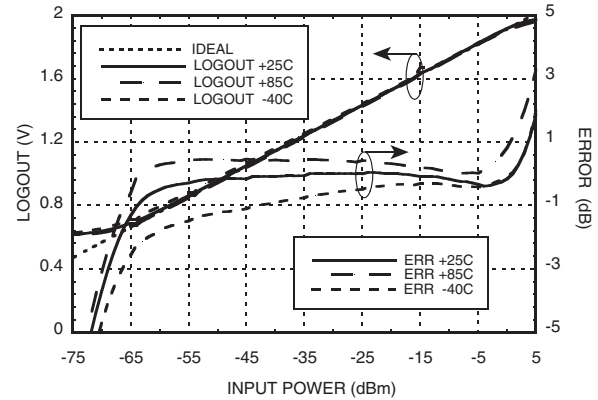

LOGOUT Voltage & Error vs. Input Power, $f_{in} = 900$ MHz

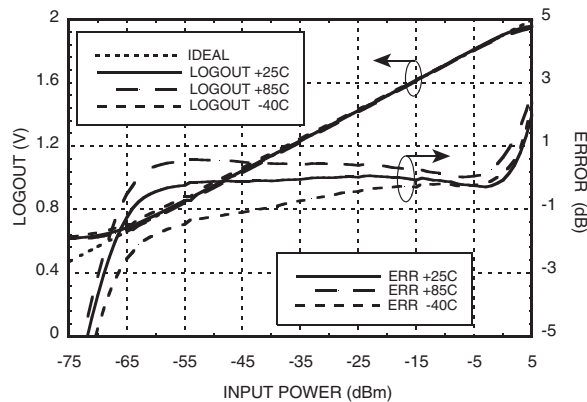

LOGOUT Voltage & Error vs. Input Power, $f_{in} = 1900$ MHz

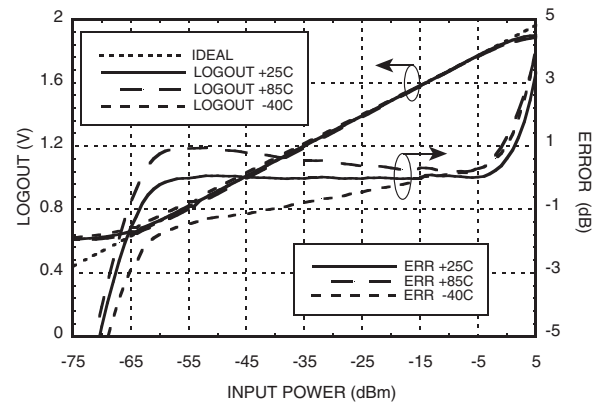

LOGOUT Voltage & Error vs. Input Power, $f_{in} = 2500$ MHz

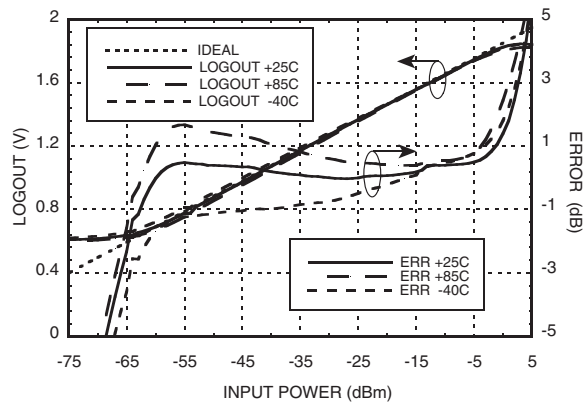

LOGOUT Voltage & Error vs. Input Power, $f_{in} = 3500$ MHz

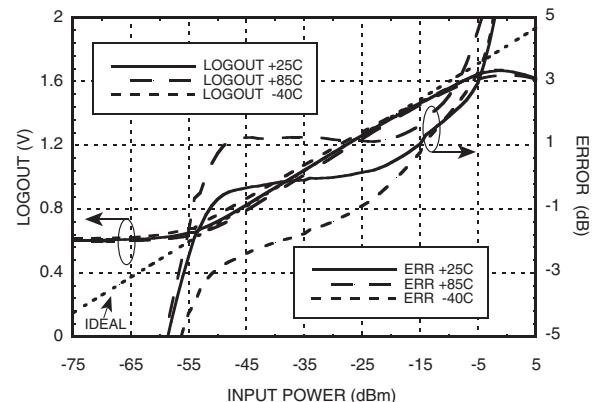

Unless otherwise noted: $V_{cc1}, V_{cc2} = +3.3V, T_A = +25C$

For price, delivery, and to place orders, please contact Hittite Microwave Corporation:
 20 Alpha Road, Chelmsford, MA 01824 Phone: 978-250-3343 Fax: 978-250-3373
 Order On-line at www.hittite.com

LOGOUT Voltage & Error vs. Input Power, $f_{in} = 4000$ MHz

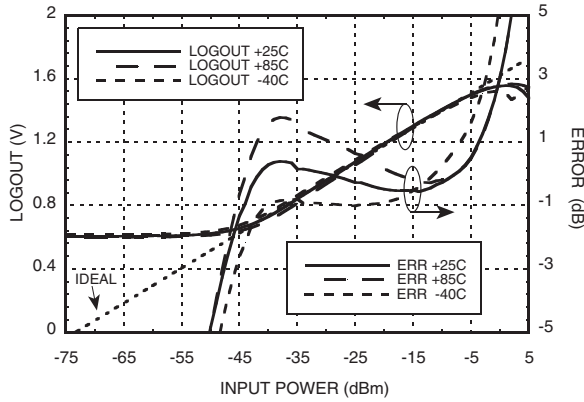

LOGOUT Slope vs. Frequency, $V_{cc} = 3.3V$

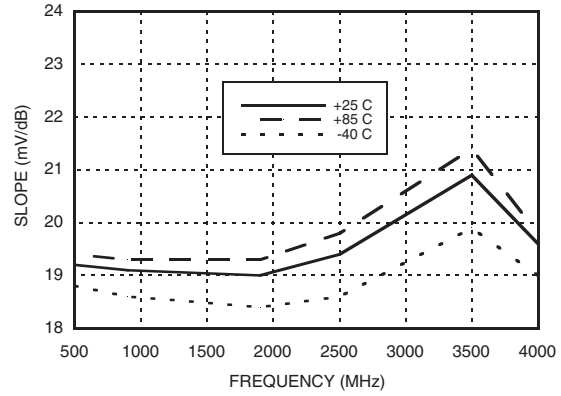

LOGOUT Slope vs. Supply Voltage, $T_A = +25C$

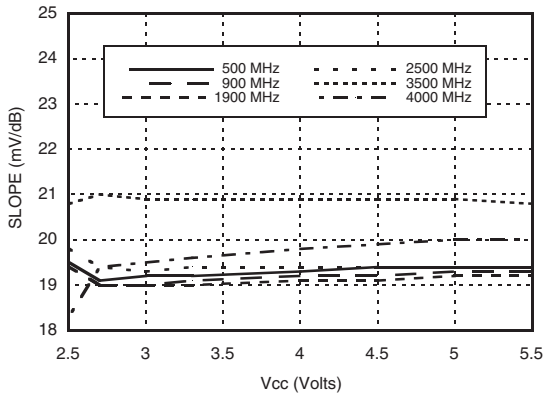

LOGOUT Intercept vs. Frequency, $V_{cc} = 3.3V$

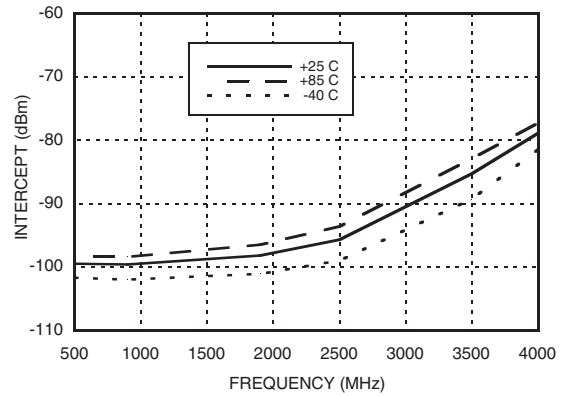

LOGOUT Intercept vs. Supply Voltage, $T_A = +25C$

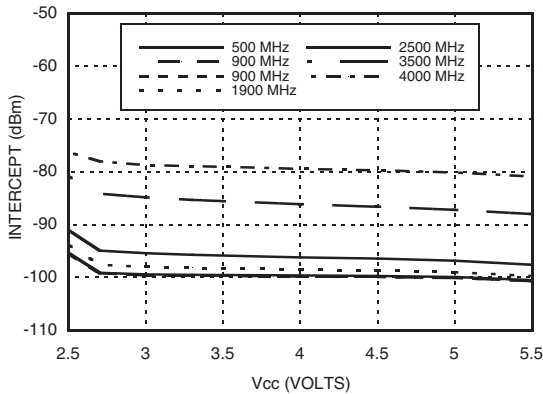

LOGOUT Error vs. Input Power, Normalized ^[2], $f_{in} = 1900$ MHz

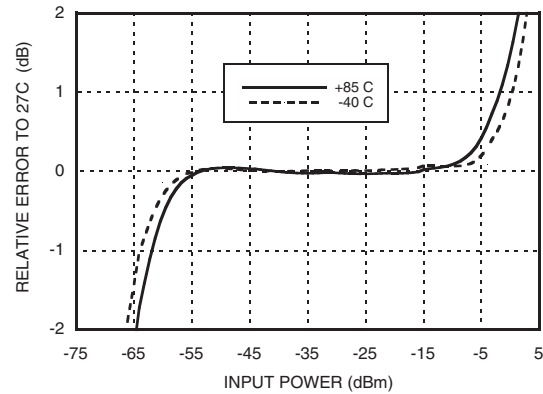

Unless otherwise noted: $V_{cc1}, V_{cc2} = +3.3V, T_A = +25C$

For price, delivery, and to place orders, please contact Hittite Microwave Corporation:
 20 Alpha Road, Chelmsford, MA 01824 Phone: 978-250-3343 Fax: 978-250-3373
 Order On-line at www.hittite.com

75 dB, FAST SETTLING, LOGARITHMIC DETECTOR / CONTROLLER 10 - 4000 MHz

Input Return Loss vs. Frequency

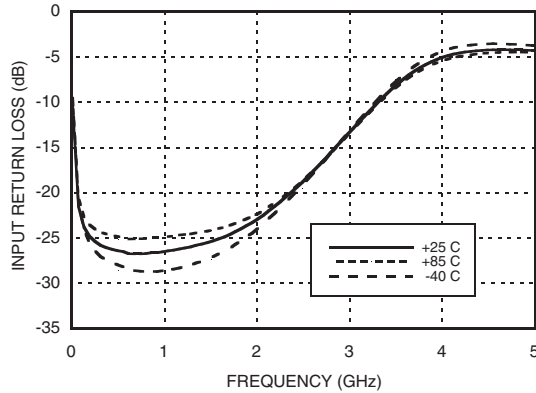

LOGOUT Voltage

vs. Input Power & Frequency, $T_A = +25^\circ\text{C}$

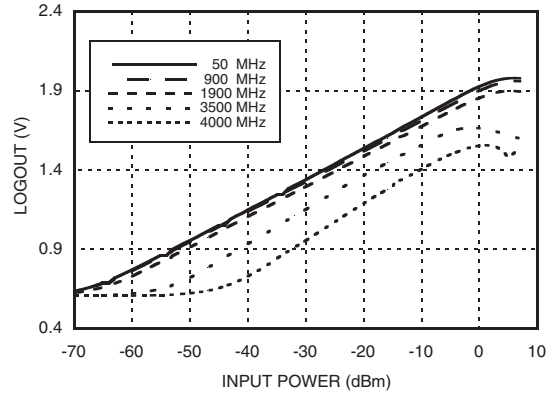

Absolute Maximum Ratings

| | |
|---|----------------|
| Vcc1, Vcc2 | 0V to +5.5V |
| PWD | 0V to +5.5V |
| VSET Input Voltage | 0V to +5.5V |
| LOGOUT Output Current | 3 mA |
| RF Input Power | +12 dBm |
| Junction Temperature | 125 °C |
| Continuous Pdiss (T = 85°C) (Derate 7.95 mW/°C above 85°C) | 0.32 Watts |
| Thermal Resistance (R _{th}) (junction to lead) | 126 °C/W |
| Storage Temperature | -65 to +150 °C |
| Operating Temperature | -40 to +85 °C |
| ESD Sensitivity (HBM) | Class 1C |



**ELECTROSTATIC SENSITIVE DEVICE
OBSERVE HANDLING PRECAUTIONS**

[1] Unless otherwise noted: Vcc1, Vcc2 = +3.3V, $T_A = +25^\circ\text{C}$
 [2] This data is relative to the room temperature performance of the HMC601LP4

Outline Drawing

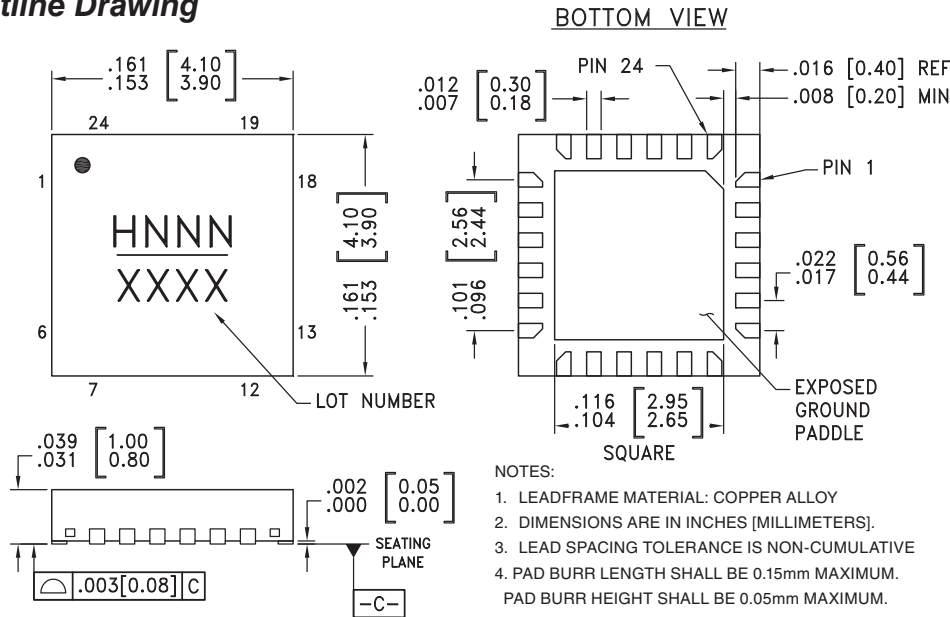

NOTES:

- LEADFRAME MATERIAL: COPPER ALLOY
- DIMENSIONS ARE IN INCHES [MILLIMETERS].
- LEAD SPACING TOLERANCE IS NON-CUMULATIVE
- PAD BURR LENGTH SHALL BE 0.15mm MAXIMUM.
PAD BURR HEIGHT SHALL BE 0.05mm MAXIMUM.
- PACKAGE WARP SHALL NOT EXCEED 0.05mm.
- ALL GROUND LEADS AND GROUND PADDLE MUST BE SOLDERED TO PCB RF GROUND.
- REFER TO HITTITE APPLICATION NOTE FOR SUGGESTED PCB LAND PATTERN.

Package Information



| Part Number | Package Body Material | Lead Finish | MSL Rating | Package Marking ^[3] |
|-------------|--|---------------|---------------------|--------------------------------|
| HMC601LP4 | Low Stress Injection Molded Plastic | Sn/Pb Solder | MSL1 ^[1] | H601 XXXX |
| HMC601LP4E | RoHS-compliant Low Stress Injection Molded Plastic | 100% matte Sn | MSL1 ^[2] | H601 XXXX |

[1] Max peak reflow temperature of 235 °C

[2] Max peak reflow temperature of 260 °C

[3] 4-Digit lot number XXXX

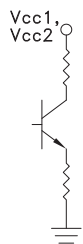
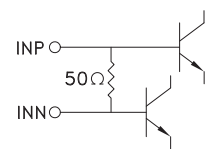
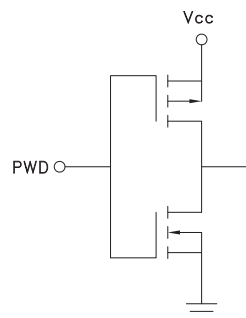
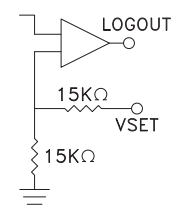
Pin Descriptions

| Pin Number | Function | Description | Interface Schematic |
|--------------------------|------------|---|---|
| 1, 6, 7-13, 15, 18-24 | N/C | These pins are not connected internally; however, this product is specified with these pins connected to RF/DC ground. | |
| 2, 5 | Vcc1, Vcc2 | Bias supply. Connect supply voltage to both pins. |  |
| 3, 4 | INP, INN | RF Input pins. Connect RF to INP, and AC couple INN to ground for single-ended operation. |  |
| 14 | PWD | Apply PWD >0.8xVcc to initiate a power saving shutdown mode. To ensure proper start-up apply the power-up sequence shown in the "Power-Up Timing Diagram" attached to the application circuit. |  |
| 16 | VSET | VSET input in controller mode. Short this pin to LOGOUT for detector mode. |  |
| 17 | LOGOUT | Logarithmic output that converts the input power to a DC level in detector mode. Short this pin to VSET for detector mode. | |
| Package Base | GND | Exposed paddle must be connected to RF and DC ground. |  |

Evaluation PCB

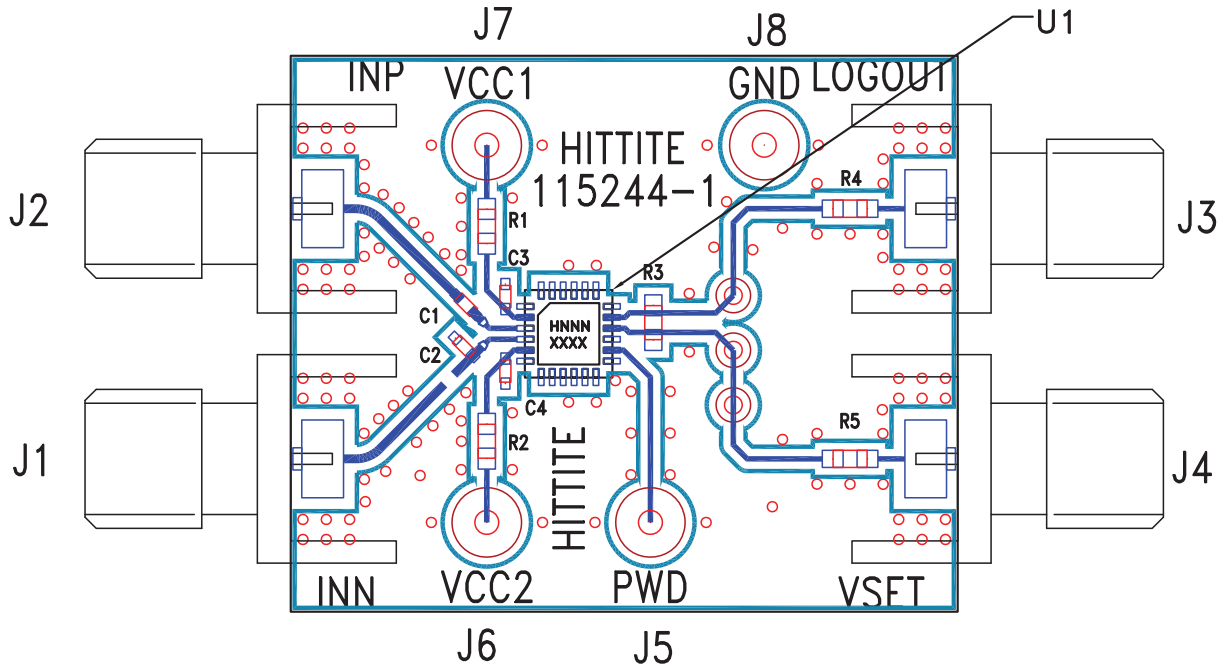

List of Materials for Evaluation PCB 115242 [1]

| Item | Description |
|---------|---|
| J1 - J4 | PC Mount SMA Connector |
| J5 - J8 | DC Pin |
| C1, C2 | 1000 pF Capacitor, 0402 Pkg. |
| C3, C4 | 0.1µF Capacitor, 0402 Pkg. |
| R1, R2 | 5.6Ω Resistor, 0603 Pkg. |
| R3-R5 | 0Ω Resistor, 0603 Pkg. |
| U1 | HMC601LP4 / HMC601LP4E Logarithmic Detector / Controller |
| PCB [2] | 115244 Evaluation PCB |

[1] Reference this number when ordering complete evaluation PCB

[2] Circuit Board Material: Rogers 4350

The circuit board used in the final application should use RF circuit design techniques. Signal lines should have 50 ohm impedance while the package ground leads and exposed paddle should be connected directly to the ground plane similar to that shown. A sufficient number of via holes should be used to connect the top and bottom ground planes. The evaluation circuit board shown is available from Hittite upon request.

Application & Evaluation PCB Schematic

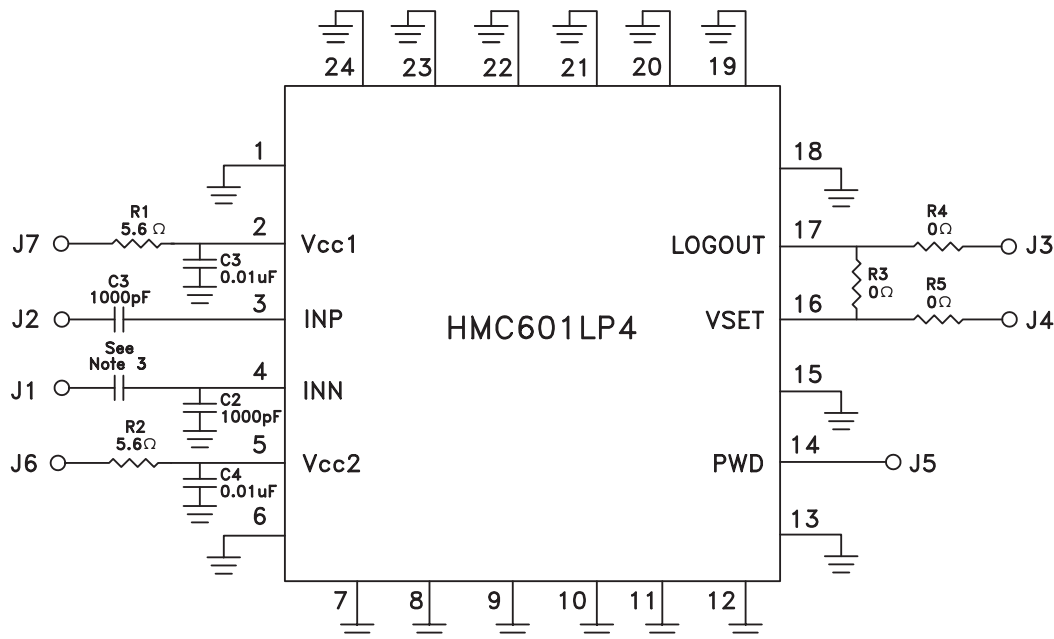

Notes

- Note 1: The HMC601LP4 & HMC601LP4E evaluation boards are pre-assembled for single-ended input, and detector/RSSI mode.
- Note 2: For single-ended input operation, use the INP port and make no connection to INN. INN is AC coupled to ground by C2
- Note 3: For differential input, remove C2, and install a 1000pF capacitor in series with INN at location shown.
- Note 4: For detector mode, connect high impedance volt meter to the LOGOUT port, and make no connection to VSET. LOGOUT is shorted to VSET by R3, as required for detector mode.
- Note 5: For controller mode, remove R3 and make appropriate connection to LOGOUT and VSET. In controller mode, the LOGOUT output can be used to drive a variable gain amplifier, or a variable attenuator, either directly or through a buffer or microcontroller. VSET should be connected to an external supply, typically between +0.6 and +1.9V.

Power-Up Timing Diagram

