

Analog Devices Welcomes Hittite Microwave Corporation

NO CONTENT ON THE ATTACHED DOCUMENT HAS CHANGED



THIS PAGE INTENTIONALLY LEFT BLANK



HMC427LP3 / 427LP3E

GaAs MMIC POSITIVE CONTROL TRANSFER SWITCH, DC* - 8 GHz

Typical Applications

The HMC427LP3 / HMC427LP3E is ideal for:

- Test Instrumentation
- Fiber Optics & Broadband Telecom
- Basestation Infrastructure
- Microwave Radio & VSAT
- Military Radios, Radar, & ECM

Features

- High Isolation: 40 ~ 45 dB thru 6 GHz
- Low Insertion Loss: 1.2 dB@ 6 GHz
- Non-Reflective Design
- 3 x 3 mm SMT Package

Functional Diagram

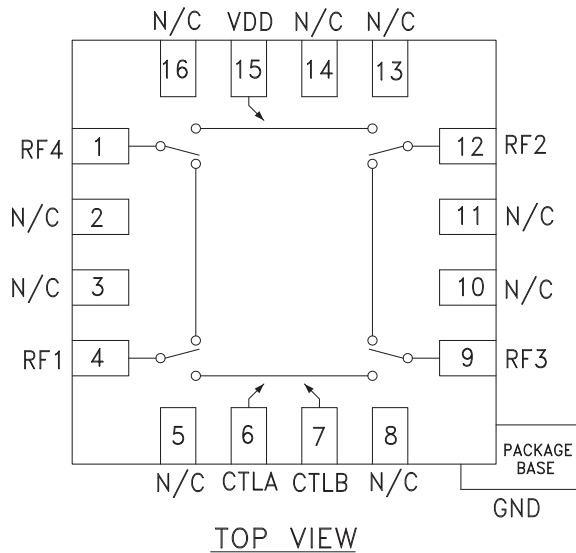

General Description

The HMC427LP3 & HMC427LP3E are low loss broadband positive control transfer switches in leadless surface mount packages. Covering DC to 8 GHz, this switch offers high isolation and low insertion loss. The switch operates using a positive control voltage of 0/+5V and requires a fixed bias of +5V @ < 20 μ A.

* Blocking capacitors are required at ports RF1, 2, 3, & 4. Their value will determine the lowest transmission frequency.

Electrical Specifications, $T_A = +25^\circ C$, With 0/+5V Control, 50 Ohm System

Parameter	Frequency	Min.	Typ.	Max.	Units
Insertion Loss	DC - 6.0 GHz		1.2	1.6	dB
	DC - 8.0 GHz		1.6	2.1	dB
Isolation	DC - 1.0 GHz	42	48		dB
	DC - 2.0 GHz	37	42		dB
	DC - 6.0 GHz	33	38		dB
	DC - 8.0 GHz	27	32		dB
Return Loss	DC - 6.0 GHz		17		dB
	DC - 8.0 GHz		15		dB
Input Power for 1 dB Compression	1.0 - 8.0 GHz	23	26		dBm
Input Third Order Intercept (Two-Tone Input Power= +7 dBm Each Tone, 1 MHz Tone Separation)	1.0 - 8.0 GHz	37	43		dBm
Switching Characteristics	DC - 8.0 GHz	tRISE, tFALL (10/90% RF)	2		ns
		tON, tOFF (50% CTL to 10/90% RF)	4		ns

Insertion Loss vs. Temperature

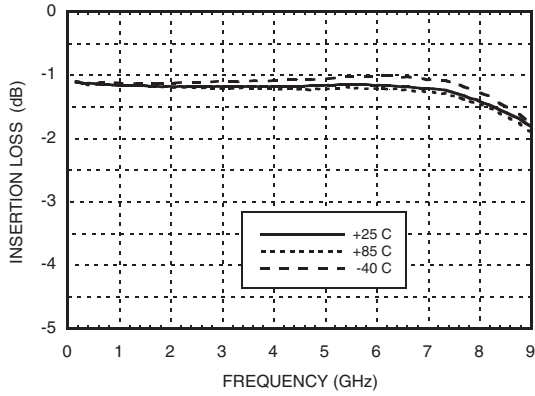

Isolation

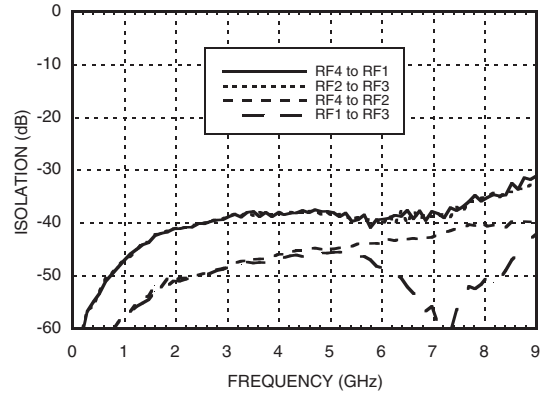

Return Loss

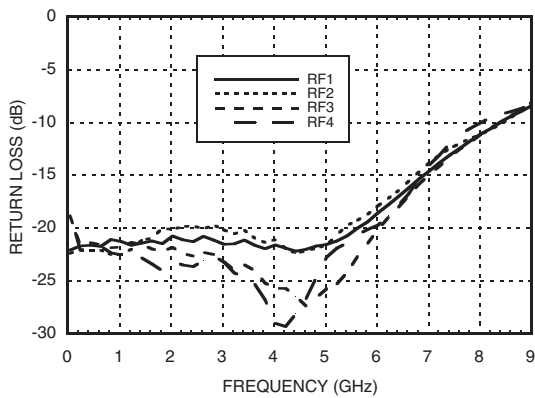

0.1 and 1 dB Input Compression Point

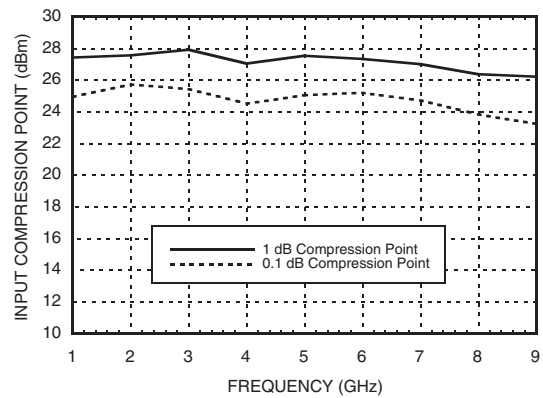

Input Third Order Intercept Point

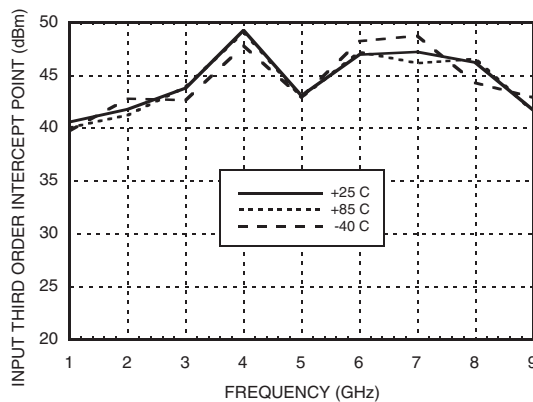



HMC427LP3 / 427LP3E

GaAs MMIC POSITIVE CONTROL TRANSFER SWITCH, DC* - 8 GHz

Absolute Maximum Ratings

Bias Voltage Range (Vdd)	+7.0 Vdc
Control Voltage Range (A & B)	-0.5V to Vdd +1.0 Vdc
Channel Temperature	150 °C
Thermal Resistance	130 °C/W
Storage Temperature	-65 to +150 °C
Operating Temperature	-40 to +85 °C
Maximum Input Power	+27 dBm
ESD Sensitivity (HBM)	Class 1A



**ELECTROSTATIC SENSITIVE DEVICE
OBSERVE HANDLING PRECAUTIONS**

Note:

DC blocking capacitors are required at ports RF1, 2, 3, & 4. Their value will determine the lowest transmission frequency.

Bias Voltage & Current

Vdd Range = +5.0 Vdc ± 10 %		
Vdd (Vdc)	Idd (Typ.) (µA)	Idd (Max.) (µA)
+5.0	5	10

Control Voltages

State	Bias Condition
Low	0 to +0.2 Vdc @ 5 µA Typical
High	Vdd ± 0.2 Vdc @ 5 µA Typical

Truth Table

Control Input		Signal Path State			
A	B	RF4 to RF2	RF1 to RF3	RF4 to RF1	RF2 to RF3
Low	High	On	On	Off	Off
High	Low	Off	Off	On	On

Outline Drawing

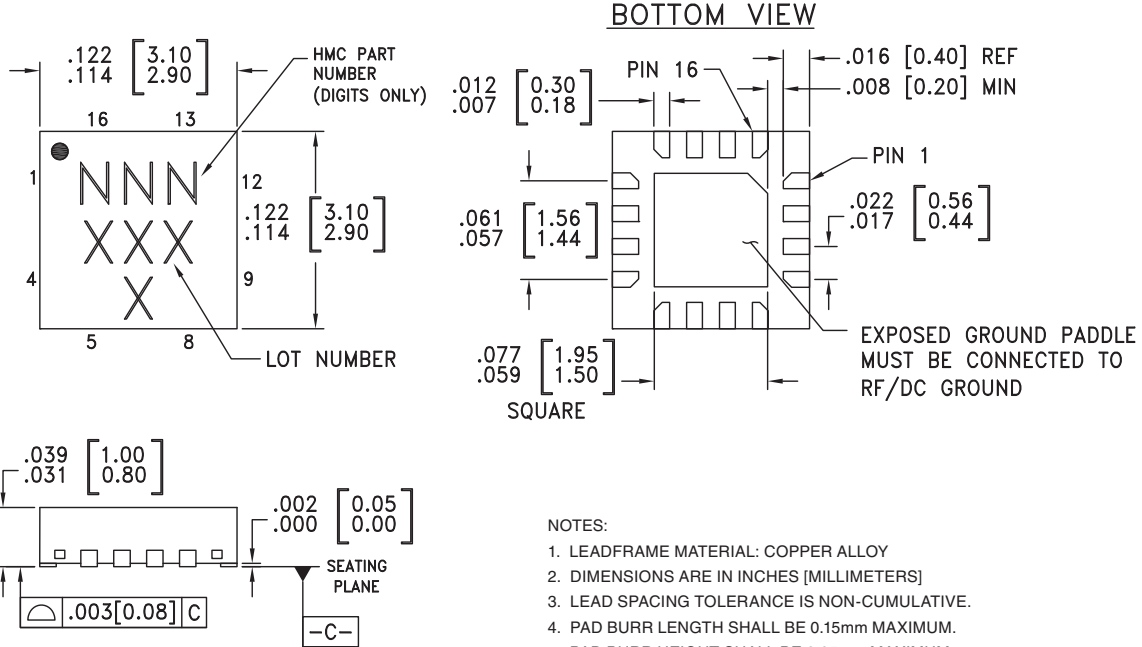

- NOTES:
1. LEADFRAME MATERIAL: COPPER ALLOY
 2. DIMENSIONS ARE IN INCHES [MILLIMETERS]
 3. LEAD SPACING TOLERANCE IS NON-CUMULATIVE.
 4. PAD BURR LENGTH SHALL BE 0.15mm MAXIMUM. PAD BURR HEIGHT SHALL BE 0.05mm MAXIMUM.
 5. PACKAGE WARP SHALL NOT EXCEED 0.05mm.
 6. ALL GROUND LEADS AND GROUND PADDLE MUST BE SOLDERED TO PCB RF GROUND.
 7. REFER TO HITTITE APPLICATION NOTE FOR SUGGESTED LAND PATTERN.

Package Information

Part Number	Package Body Material	Lead Finish	MSL Rating	Package Marking ^[3]
HMC427LP3	Low Stress Injection Molded Plastic	Sn/Pb Solder	MSL1 ^[1]	427 XXXX
HMC427LP3E	RoHS-compliant Low Stress Injection Molded Plastic	100% matte Sn	MSL1 ^[2]	427 XXXX

[1] Max peak reflow temperature of 235 °C
 [2] Max peak reflow temperature of 260 °C
 [3] 4-Digit lot number XXXX

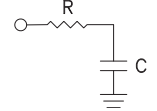
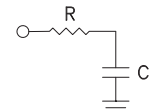

Pin Descriptions

Pin Number	Function	Description	Interface Schematic
1, 4, 9, 12	RF4, RF1, RF3, RF2	This pin is DC coupled and matched to 50 Ohm. Blocking capacitors are required.	
2, 3, 5, 8, 10, 11, 13, 14, 16	N/C	This pin should be connected to PCB RF ground to maximize isolation.	
	GND	Package bottom has exposed metal paddle that must be connected to PCB RF ground.	
6	CTRLA	See truth table and control voltage table.	
7	CTRLB	See truth table and control voltage table.	
15	VDD	Supply Voltage +5V ± 10%.	

Evaluation PCB

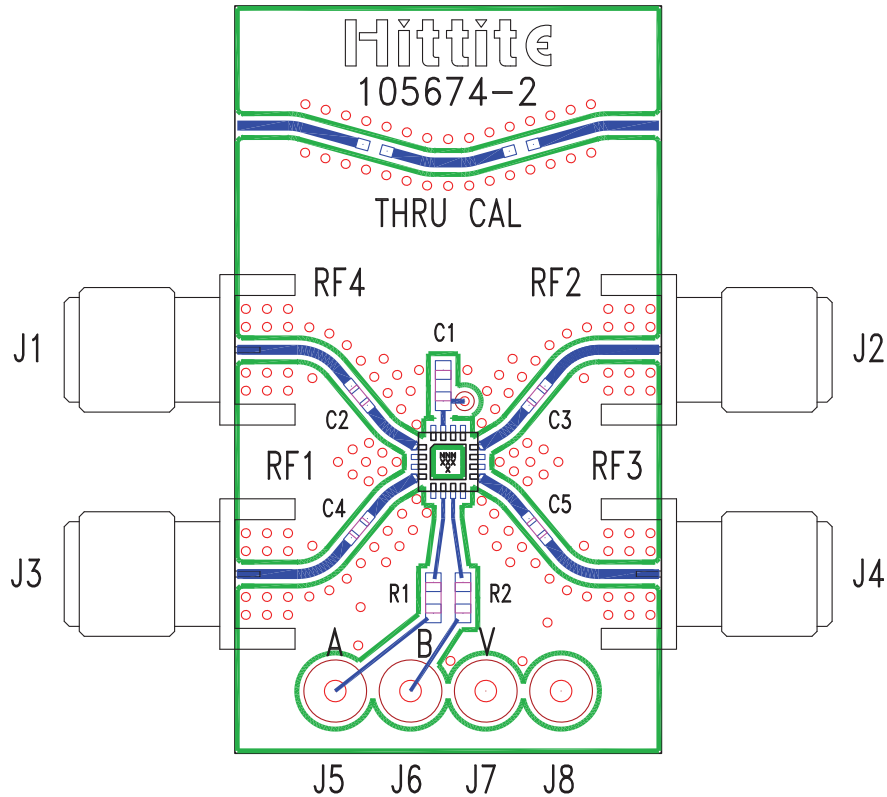

List of Materials for Evaluation PCB 105672 ^[1]

Item	Description
J1 - J4	PCB Mount SMA RF Connector
J5 - J8	DC Pin
C1	1000 pF Capacitor, 0603 Pkg.
C2 - C5	100 pF Capacitor, 0402 Pkg.
R1 - R2	100 Ohm Resistor, 0603 Pkg.
U1	HMC427LP3 / HMC427LP3E Transfer Switch
PCB ^[2]	105674 Evaluation PCB

[1] Reference this number when ordering complete evaluation PCB

[2] Circuit Board Material: Rogers 4350

The circuit board used in the final application should be generated with proper RF circuit design techniques. Signal lines at the RF port should have 50 ohm impedance and the package ground leads and package bottom should be connected directly to the ground plane similar to that shown above. The evaluation circuit board shown above is available from Hittite Microwave Corporation upon request.