

# Analog Devices Welcomes Hittite Microwave Corporation

NO CONTENT ON THE ATTACHED DOCUMENT HAS CHANGED



**THIS PAGE INTENTIONALLY LEFT BLANK**

### Typical Applications

Prescaler for DC to Ku Band PLL Applications:

- Satellite Communication Systems
- Fiber Optic
- Point-to-Point and Point-to-Multi-Point Radios
- VSAT

### Features

- Ultra Low SSB Phase Noise: -151 dBc/Hz
- Wide Bandwidth
- Output Power: 5 dBm
- Single DC Supply: +5V
- S8G SMT Package

### Functional Diagram

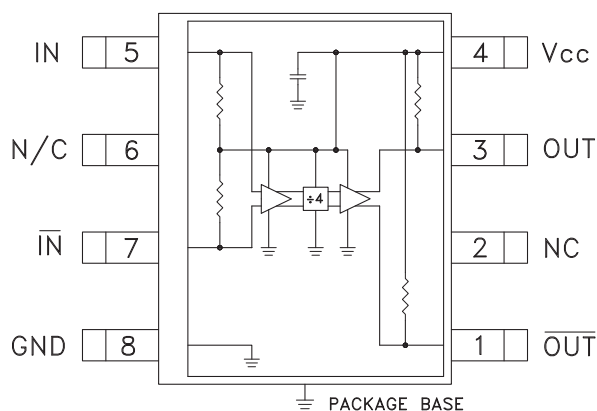

### General Description

The HMC365S8G & HMC365S8GE are low noise Divide-by-4 Static Dividers with InGaP GaAs HBT technology in 8 lead surface mount plastic packages. This device operates from DC (with a square wave input) to 13 GHz input frequency with a single +5V DC supply. The low additive SSB phase noise of -151 dBc/Hz at 100 kHz offset helps the user maintain good system noise performance.

### Electrical Specifications, $T_A = +25^\circ\text{C}$ , 50 Ohm System, $V_{CC} = 5V$

| Parameter                        | Conditions                            | Min. | Typ. | Max. | Units  |
|----------------------------------|---------------------------------------|------|------|------|--------|
| Maximum Input Frequency          |                                       | 13   | 14   |      | GHz    |
| Minimum Input Frequency          | Sine Wave Input. [1]                  |      | 0.2  | 0.5  | GHz    |
| Input Power Range                | $F_{in} = 1$ to 8 GHz                 | -15  | >-20 | +10  | dBm    |
|                                  | $F_{in} = 8$ to 11 GHz                | -10  | >-15 | +3   | dBm    |
|                                  | $F_{in} = 11$ to 13 GHz               | -5   | >-8  | +3   | dBm    |
| Output Power                     | $F_{in} = 13$ GHz                     | 2    | 5    |      | dBm    |
| Reverse Leakage                  | Both RF Outputs Terminated            |      | 45   |      | dB     |
| SSB Phase Noise (100 kHz offset) | $P_{in} = 0$ dBm, $F_{in} = 6$ GHz    |      | -151 |      | dBc/Hz |
| Output Transition Time           | $P_{in} = 0$ dBm, $F_{out} = 882$ MHz |      | 100  |      | ps     |
| Supply Current ( $I_{CC}$ )      |                                       |      | 110  |      | mA     |

1. Divider will operate down to DC for square-wave input signal.



**Input Sensitivity Window, T= 25 °C**

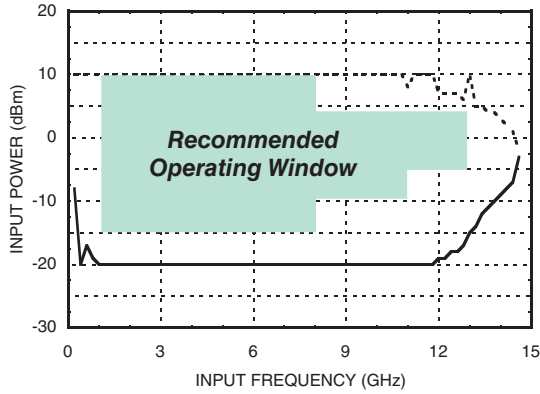

**Input Sensitivity Window vs. Temperature**

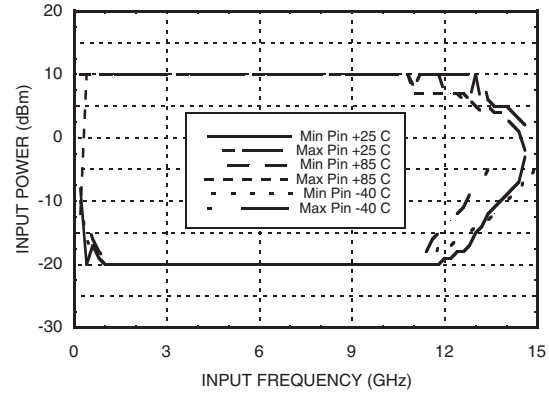

**Output Power vs. Temperature**

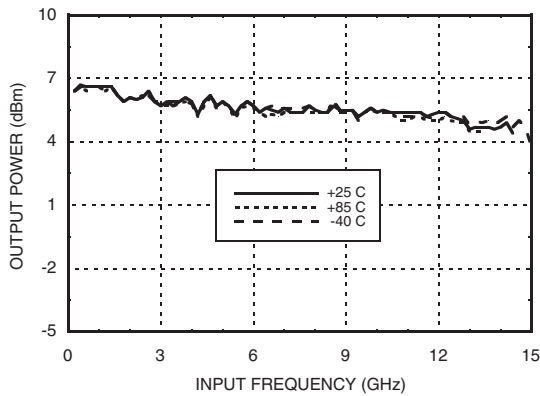

**SSB Phase Noise**

**Performance, Pin= 0 dBm, T= 25 °C**

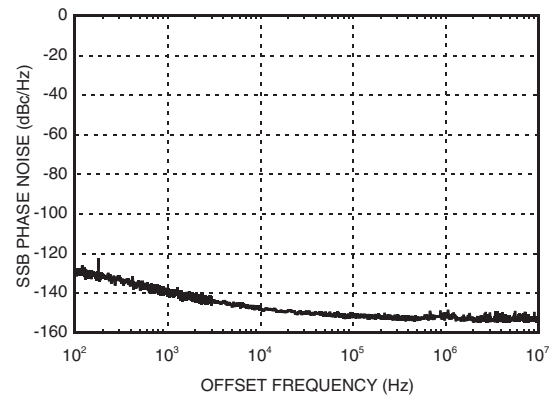

**Output Harmonic**

**Content, Pin= 0 dBm, T= 25 °C**

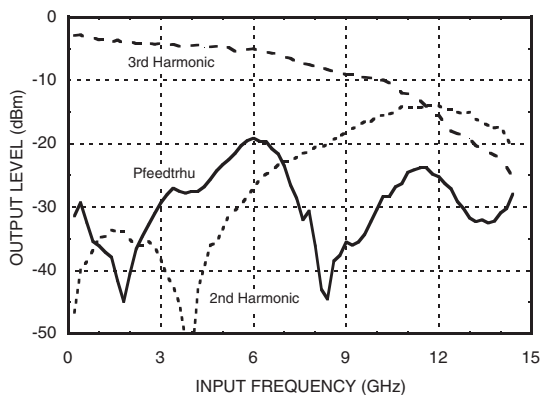

**Reverse Leakage, Pin= 0 dBm, T= 25 °C**

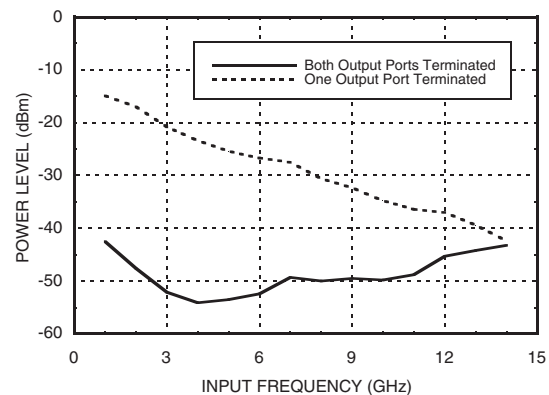

### Output Voltage Waveform, Pin= 0 dBm, Fout= 882 MHz, T= 25 °C

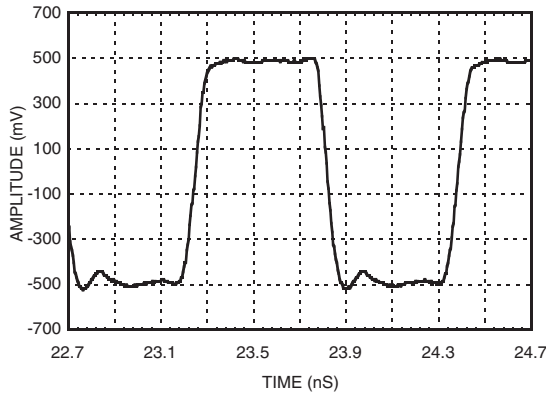

### Absolute Maximum Ratings

|                                                                        |                  |
|------------------------------------------------------------------------|------------------|
| RF Input (Vcc = +5V)                                                   | +13 dBm          |
| Vcc                                                                    | +5.5V            |
| Junction Temperature                                                   | 135 °C           |
| Continuous P <sub>diss</sub> (T= 85°C)<br>(derate 15 mW/°C above 85°C) | 760 mW           |
| Thermal Resistance (RTH)<br>(junction to ground paddle)                | 65.8 °C/W        |
| Storage Temperature                                                    | -65 to +150 °C   |
| Operating Temperature                                                  | -40 to to +85 °C |



**ELECTROSTATIC SENSITIVE DEVICE  
OBSERVE HANDLING PRECAUTIONS**

### Typical Supply Current vs. Vcc

| Vcc (V) | Icc (mA) |
|---------|----------|
| 4.75    | 94       |
| 5.0     | 110      |
| 5.25    | 118      |

Note: Divider will operate over full voltage range shown above

### Outline Drawing

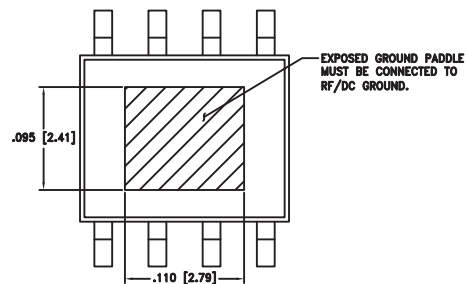
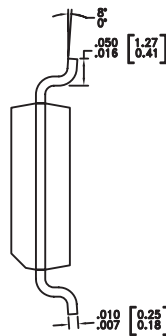
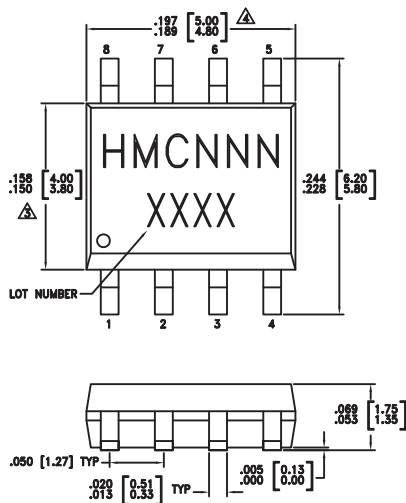

NOTES:

- LEADFRAME MATERIAL: COPPER ALLOY
- DIMENSIONS ARE IN INCHES [MILLIMETERS]
- DIMENSION DOES NOT INCLUDE MOLDFLASH OF 0.15mm PER SIDE.
- DIMENSION DOES NOT INCLUDE MOLDFLASH OF 0.25mm PER SIDE.
- ALL GROUND LEADS AND GROUND PADDLE MUST BE SOLDERED TO PCB RF GROUND.

### Package Information

| Part Number | Package Body Material                              | Lead Finish   | MSL Rating          | Package Marking <sup>[3]</sup> |
|-------------|----------------------------------------------------|---------------|---------------------|--------------------------------|
| HMC365S8G   | Low Stress Injection Molded Plastic                | Sn/Pb Solder  | MSL1 <sup>[1]</sup> | HMC365<br>XXXX                 |
| HMC365S8GE  | RoHS-compliant Low Stress Injection Molded Plastic | 100% matte Sn | MSL1 <sup>[2]</sup> | HMC365<br>XXXX                 |

[1] Max peak reflow temperature of 235 °C



[2] Max peak reflow temperature of 260 °C

[3] 4-Digit lot number XXXX

For price, delivery, and to place orders, please contact Hittite Microwave Corporation:  
20 Alpha Road, Chelmsford, MA 01824 Phone: 978-250-3343 Fax: 978-250-3373  
Order On-line at [www.hittite.com](http://www.hittite.com)

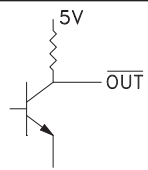
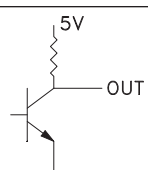
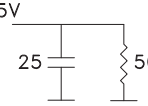
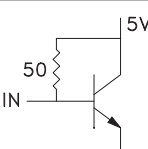
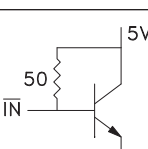

## Pin Description

| Pin Number | Function                | Description                                                                                                | Interface Schematic                                                                   |
|------------|-------------------------|------------------------------------------------------------------------------------------------------------|---------------------------------------------------------------------------------------|
| 1          | $\overline{\text{OUT}}$ | Divided output 180° out of phase with pin 3.                                                               |    |
| 2, 6       | N/C                     | No connection. These pins must not be grounded.                                                            |                                                                                       |
| 3          | OUT                     | Divided Output.                                                                                            |    |
| 4          | Vcc                     | Supply voltage 5V ± 0.25V.                                                                                 |    |
| 5          | IN                      | RF Input must be DC blocked.                                                                               |   |
| 7          | $\overline{\text{IN}}$  | RF Input 180° out of phase with pin 5 for differential operation.<br>A/C ground for single ended operation |  |
| 8          | GND                     | Ground Backside of package has exposed metal ground paddle which must be connected to ground.              |  |

**Evaluation PCB**

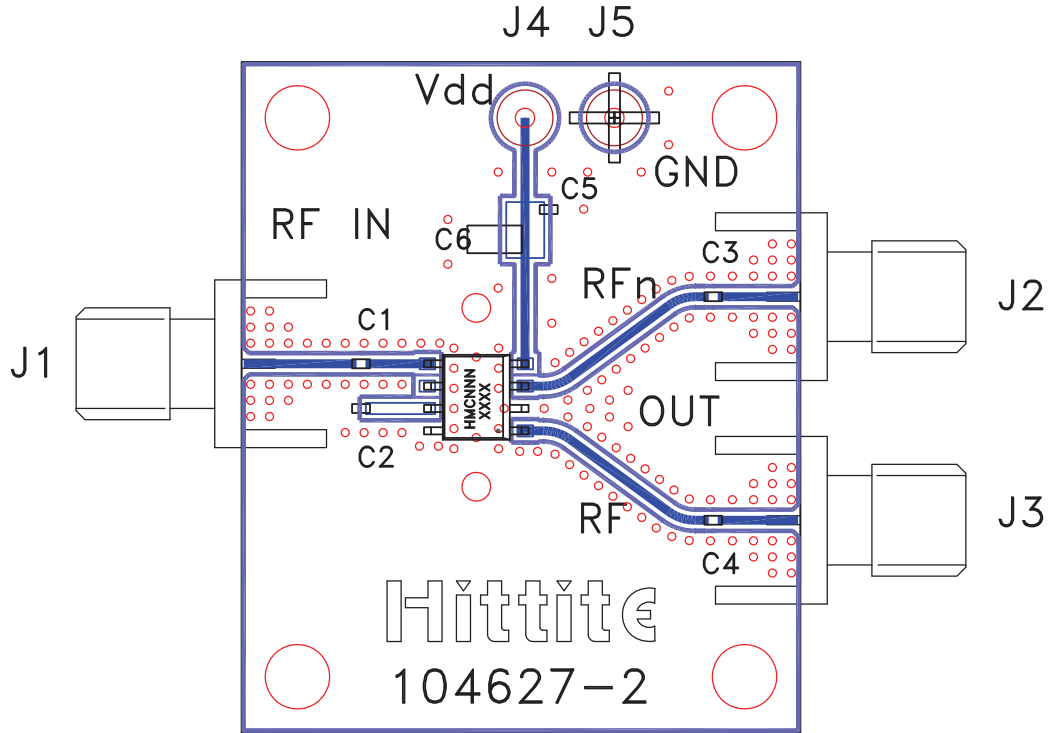

**List of Materials for Evaluation PCB 104631 [1]**

| Item    | Description                        |
|---------|------------------------------------|
| J1 - J3 | PCB Mount SMA RF Connector         |
| C1 - C4 | 100 pF Capacitor, 0402 Pkg.        |
| C5      | 1000 pF Capacitor, 0603 Pkg.       |
| C6      | 10 $\mu$ F Tantalum Capacitor      |
| U1      | HMC365S8G / HMC365S8GE Divide-by-4 |
| PCB [2] | 104627 Eval Board                  |

[1] Reference this number when ordering complete evaluation PCB

[2] Circuit Board Material: Rogers 4350

The circuit board used in the final application should use RF circuit design techniques. Signal lines should have 50 ohm impedance while the package ground leads and backside ground slug should be connected directly to the ground plane similar to that shown. A sufficient number of via holes should be used to connect the top and bottom ground planes. The evaluation circuit board shown is available from Hittite upon request. This evaluation board is designed for single ended input testing. J2 and J3 provide differential output signals.



#### Application Circuit

