

REV. NO.	DATE	DESCRIPTION	BY	CHKD	APPD
E3	12-FEB-02	REVISED PER ECO-09-022197			
F1	16-JAN-10	O-RING GREEN REPLACED BY O-RINGS NATURAL COLOR			
F2	25MAR2010	NEW PRODUCT NUMBERS ADDED PER PCN E-10-006236			

QTY	UNIT	DESCRIPTION	REVISIONS	DATE	BY	CHKD	APPD
1		29 SOLAR CABLE, 4mm ² /12AWG, TE, TYPE, ZHSCG, 90mm LONG	△				
1		28 SOLAR CABLE, 4mm ² /12AWG, TE, TYPE, ZHSCG, 90mm LONG	△				
1		27 TERMINAL SPADE	△				
1		26 SOLAR CABLE, 4mm ² /12AWG, TE, TYPE, ZHSCG, 220mm LONG	△				
1		25 SOLAR CABLE, 4mm ² /12AWG, TE, TYPE, ZHSCG, 220mm LONG	△				
1		24 FERULLE, UNINSULATED	△				
1		23 WIRE 6mm ² , CA, 190mm ±5mm LONG	△				
1		22 FLAT SEAL	△				
1		21 FLAT SEAL	△				
1		20 WIRE 4mm ² , CA, 190mm ±5mm LONG	△				
1		19 NUT M12x1.5	△				
1		18 FLAT SEAL	△				
1		17 WIRE 4mm ² , CA, 220mm ±5mm LONG	△				
1		16 RING TONGUE	△				
1		15 WIRE 4mm ² , CA, 220mm ±5mm LONG	△				
1		14 PLASTIC BAG	△				
1		13 MINIGRIP BAG	△				
1		12 MINIGRIP BAG	△				
1		11 WIRE 4mm ² , CA, 250mm ±5mm LONG	△				
1		10 WIRE 2.5mm ² , CA, 250mm ±5mm LONG	△				
1		9 NUT M12x1.5	△				
1		8 O-RING	△				
1		7 PLOG COVER	△				
1		6 SINGLE-WIRE SEAL	△				
1		5 PIN CONTACT ASSY HVT 6mm ² / AWG 10	△				
1		4 PIN CONTACT ASSY HVT 4mm ² / AWG 12	△				
1		3 PIN CONTACT ASSY HVT 2.5mm ² / AWG 14	△				
1		2 PIN HOUSING MINUS CODING	△				

PART-NO.
BESTELL-NR.

<p>PIECES STUECK</p>	<p>TER-NO. POS.</p>	<p>DESCRIPTION BENENNUNG</p>	<p>DATE 12-FEB-02</p>	<p>BY E. WERNER</p>	<p>CHKD H. SCHUBER</p>	<p>APPD E. WERNER</p>	<p>SCALE 1:1</p>	<p>REVISIONS REVISED PER ECO-09-022197</p>	<p>DATE 12-FEB-02</p>	<p>BY E. WERNER</p>	<p>CHKD H. SCHUBER</p>	<p>APPD E. WERNER</p>
<p>CONNECTION FOR INVERTED CONVERTER ANSCHLUSS FUER WECHSELRICHTER</p>			<p>TYCO ELECTRONICS D - 64625 Bockenheim</p>			<p>SCALE 1:1</p>			<p>REVISIONS REVISED PER ECO-09-022197</p>			
<p>TOLERANCING ISO 8015 TOLERIERUNG ISO 8015</p>			<p>CUSTOMER DRAWING KUNDENZIEICHUNG</p>			<p>SCALE 1:1</p>			<p>REVISIONS REVISED PER ECO-09-022197</p>			

4

3

2

1

RELEASED FOR PUBLICATION FOR USE: UNRESTRICTED	16-JAN-06	DATE WITH EFFECTIVE
BY TYCO ELECTRONICS CORPORATION. ALL RIGHTS RESERVED. © COPYRIGHT 2002		

LOC	QTY	REV	REVISIONS	DATE	BY	APPD
A1	-	1	REVISIONS			
			ANNOUÏNCIATION			
			DESCRIPTION			
			REVISIONS			
PROJ. NO.						
EQ. REF. NO.						
			SEE SHEET 1			

- ▲ PACKAGING INSTRUCTION: 100 PIECES OF EACH PART PACKAGED IN MINIGRIP BAG (ITEM NO. 13)
- ▲ PACKAGING INSTRUCTION: 100 PIECES OF EACH PART PACKAGED IN PLASTIC BAG (ITEM NO. 14)
- ▲ PACKAGING UNIT: ALL COMPONENTS OF EACH DASH-NUMBER PACKAGED ACCORDING TO ▲ OR ▲ PACKAGED IN CORRUGATED SHIPPING BOX
- ▲ USE ONLY SOLAR CABLE TYPE: ROME USE-2
- ▲ STRANDED WIRE 2.5mm², 4mm² AND 6mm²
VOLTAGE RATING U0/U = 600V/1000V.
TEMPERATURE RANGE -40°C / +115°C
- ▲ MINIGRIP BAGS (ITEM NO. 12) AND (ITEM NO. 13) AND PLASTIC BAG (ITEM NO. 14) NOT SHOWN
- ▲ RECOMMENDED TIGHTENING TORQUE FOR NUT (ITEM NO. 9) OR (ITEM NO. 19) WHEN ASSEMBLING AT HOUSING WALL 1.3^{+0.2} Nm
- ▲ ITEM NO. 4, 18 AND ITEM NO. 20 MOUNTED WITH ITEM NO. 1 OR 2 AND PACKAGED IN PLASTIC BAG (ITEM NO. 14).
ITEM NO. 9 PACKAGED IN MINIGRIP BAG (ITEM NO. 13) AND ENCLOSED IN PLASTIC BAG (ITEM NO. 14).
- ▲ ITEM NO. 5, 21 AND ITEM NO. 23 MOUNTED WITH ITEM NO. 1 AND PACKAGED IN PLASTIC BAG (ITEM NO. 14).
ITEM NO. 9 PACKAGED IN MINIGRIP BAG (ITEM NO. 13) AND ENCLOSED IN PLASTIC BAG (ITEM NO. 14).
- ▲ ITEM NO. 5, 22 AND ITEM NO. 23 MOUNTED WITH ITEM NO. 2 AND PACKAGED IN PLASTIC BAG (ITEM NO. 14).
ITEM NO. 9 PACKAGED IN MINIGRIP BAG (ITEM NO. 13) AND ENCLOSED IN PLASTIC BAG (ITEM NO. 14).
- ▲ PACKAGING UNIT: 400 PIECES
MINIMUM ORDER QUANTITY: 400 PIECES

- ▲ VERPACKUNGSANWEISUNG: 100 STÜCK VON JEDEM TEIL IM MINIGRIP-BEUTEL (POS. 13) VERPACKT
- ▲ VERPACKUNGSANWEISUNG: 100 STÜCK VON JEDEM TEIL IM KUNSTSTOFF-BEUTEL (POS. 14) VERPACKT
- ▲ VERPACKUNGSEINHEIT: ALLE KOMPONENTEN EINER STRICHVARIANTE VERPACKT GEMÄSS ▲ BZW. ▲ IM VERSANDKARTON VERPACKT
- ▲ NUR SOLARKABEL TYP: ROME USE-2 VERWENDEN
- ▲ LITZE 2.5mm², 4mm² UND 6mm²
NENNSPANNUNG U0/U = 600V/1000V.
TEMPERATURBEREICH -40°C / +115°C
- ▲ MINIGRIP-BEUTEL (POS. 12) UND (POS. 13) UND KUNSTSTOFF-BEUTEL (POS. 14) NICHT DARGESTELLT
- ▲ EMPFOHLENES ANZUGSDREHMOMENT FÜR BEFESTIGUNGSMUTTER (POS. 9) ODER (POS. 19) BEI MONTAGE AN GEHÄUSEWAND 1.3^{+0.2} Nm
- ▲ POS. 4, 18 UND POS. 20 MONTIERT MIT POS. 1 ODER 2 UND VERPACKT IN KUNSTSTOFF-BEUTEL (POS. 14).
POS. 9 VERPACKT IN MINIGRIP-BEUTEL (POS. 13) UND IN KUNSTSTOFF-BEUTEL (POS. 14) BEIGELEGT.
- ▲ POS. 5, 21 UND ITEM NO. 23 MONTIERT MIT POS. 1 UND VERPACKT IN KUNSTSTOFF-BEUTEL (POS. 14).
POS. 9 VERPACKT IN MINIGRIP-BEUTEL (POS. 13) UND IN KUNSTSTOFF-BEUTEL (POS. 14) BEIGELEGT.
- ▲ POS. 5, 22 UND ITEM NO. 23 MONTIERT MIT POS. 2 UND VERPACKT IN KUNSTSTOFF-BEUTEL (POS. 14).
POS. 9 VERPACKT IN MINIGRIP-BEUTEL (POS. 13) UND IN KUNSTSTOFF-BEUTEL (POS. 14) BEIGELEGT.
- ▲ VERPACKUNGSEINHEIT: 400 STÜCK
MINDESTBESTELLMENGE: 400 STÜCK

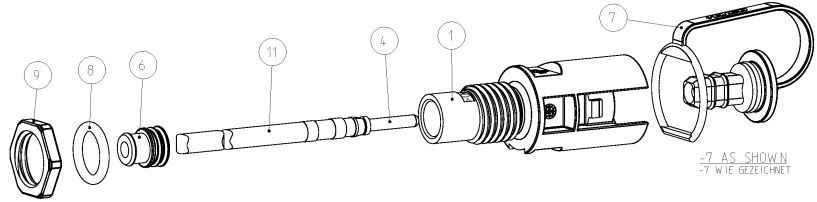

TYP: VERWENDETE ZUSÄTZLICHE BEZEICHNUNGSZEICHEN BEI DER VERWENDEUNG VON ZEICHEN FÜR VERWENDETE BEZEICHNUNGSZEICHEN VERWENDETE ZEICHEN FÜR VERWENDETE BEZEICHNUNGSZEICHEN		DWN 16-JAN-06 LEWERNER 16-JAN-06 HILSCHEBER 16-JAN-06	Tyco Electronics AMP GmbH D - 64625 Bensheim
ZEICHEN FÜR VERWENDETE ZEICHEN	ZEICHEN FÜR VERWENDETE ZEICHEN	NAME CONNECTION FOR INVERTED CONVERTER ANSCHLUSS FUER WECHSELRICHTER	
MATERIAL -	FINISCHWARZ/BLACK	APPLICATION SPEC DRAWING TOLERANCES 16-18488	SCALE 1:1
CUSTOMER DRAWING		KUNDENZEICHNUNG	SCALE 1:1
		SHEET 2	OF 2
		REF 2	

4

RELEASED FOR PUBLICATION
 FOR USE: UNRESTRICTED
 BY TYCO ELECTRONICS CORPORATION. ALL RIGHTS RESERVED.
 (C) COPYRIGHT 2001

DATE: 2/16/01

SECTION A-A
 SCHNITT A-A

SECTION A-A
 SCHNITT A-A

1-7 AS SHOWN
 1-7 WIE BEZEICHNET

△ **PACKAGING INSTRUCTION:** CONNECTION FOR INVERTED CONVERTER PACKAGED IN MINIGRIP BAG (ITEM NO. 12) PER TE-SPEC. 107-18052.
 O-RING (ITEM NO. 8), NUT M12x1.5 (ITEM NO. 9),
 PIN CONTACT ASSY HVT 2.5mm² / AWG 14 (ITEM NO. 3),
 PIN CONTACT ASSY HVT 4mm² / AWG 12 (ITEM NO. 4)
 AND PIN CONTACT ASSY HVT AWG 10 (ITEM NO. 5)
 ENCLOSE LOOSELY IN MINIGRIP BAG (ITEM NO. 12).

SCALE 1:1 / M 1:1

△ **PACKAGING UNIT:** 100 PIECES PACKAGED PARTS ACCORDING TO △ PACKAGED IN CORRUGATED SHIPPING BOX.

△ **MINIMUM ORDER QUANTITY:** 100 PIECES

△ **VERPACKUNGSANWEISUNG:** ANSCHLUSS FÜR WECHSELRICHTER IM MINIGRIP-BEUTEL (POS. 12) NACH TE-SPEZ. 107-18052 VERPACKT.
 O-RING (POS. 8), MUTTER M12x1.5 (POS. 9),
 KONTAKTSTIFT ASSY HVT 2.5mm² / AWG 14 (POS. 3),
 KONTAKTSTIFT ASSY HVT 4mm² / AWG 12 (POS. 4)
 UND KONTAKTSTIFT ASSY HVT AWG 10 (POS. 5)
 IM MINIGRIP-BEUTEL (POS. 12) LOSE BEIGELEGT.

△ **VERPACKUNGSEINHEIT:** 100 STÜCK VERPACKTE TEILE GEMÄSS △ IM VERSANDKARTON VERPACKT.

△ **MINDESTBESTELLMENGE:** 100 STÜCK

2

REVISIONS
 ANMERKUNGEN
 DESCRIPTION
 BEZUGSNUMMERN

REV.	DATE	BY	APP'D
1	-	-	-

PROJECT NO.: EGE.02.0020

SEE SHEET 1

SECTION A-A
 SCHNITT A-A

SECTION A-A
 SCHNITT A-A

1-8 AS SHOWN
 1-8 WIE BEZEICHNET

SCALE 1:1 / M 1:1

DATE	26-FEB-01	BY	EL WERNER
DATE	26-FEB-01	BY	EL SCHERER
DATE	26-FEB-01	BY	EL FIEDMEIER

NAME: CONNECTION FOR INVERTED CONVERTER
 ANSCHLUSS FUER WECHSELRICHTER

TYCO ELECTRONICS
 Tyco Electronics AMP GmbH
 D - 64625 Bensheim

STYL	A2	CAGE CODE	00779	DRAWING NO.	1394738	RESTRICTED TO	-
SCALE	1:1	SHEET	3	OF	6	REV	2

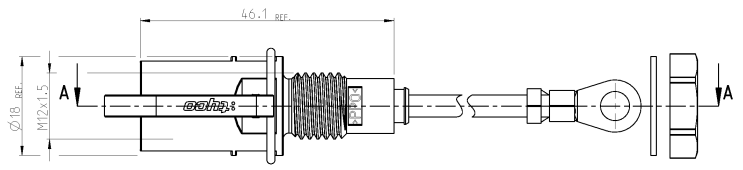

SECTION A-A
 SCHNITT A-A

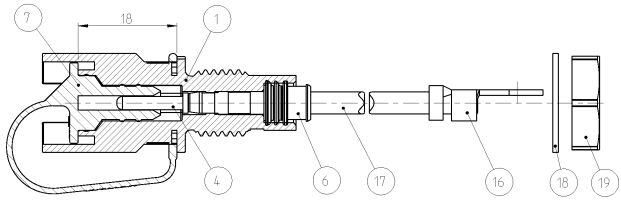

2-3 AS SHOWN
 2-3 WIE BEZEICHNET

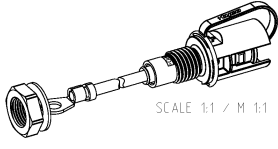

- ▲ ITEM NO. 4, 6, 7, 16 AND 17 MOUNTED WITH ITEM NO. 1 OR 2. ITEM NO. 18 AND 19 ENCLOSE LOOSELY.
- ▲ PACKAGING: SEE PN 1534900
- ▲ POS. 4, 6, 7, 16 UND 17 MIT POS. 1 BZW. 2 MONTIERT. POS. 18 UND 19 LOSE BEIGELEGT.
- ▲ VERPACKUNG: SIEHE PN 1534900

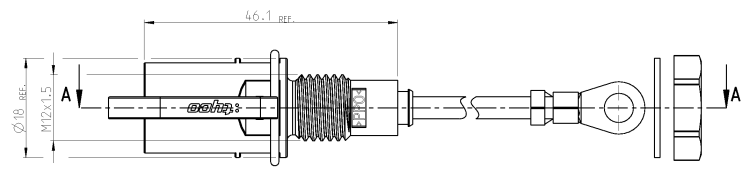

SECTION A-A
 SCHNITT A-A

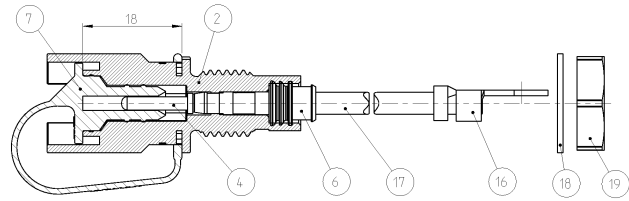

2-4 AS SHOWN
 2-4 WIE BEZEICHNET

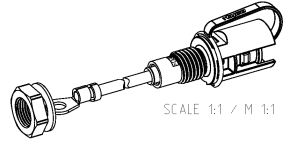

DRAWING TITLE: ANSCHLUSS FÜR UMGEKEHRTEN WECHSELRICHTER DRAWING NO.: 16440200 PROJECT NO.: 16440200		DATE: 17-JUL-02 DRAWN BY: J. WERNER CHECKED BY: J. SCHNEIDER PROJECT: 17-JUL-02 DRAWING NO.: 16440200 PROJECT NO.: 16440200	NAME: Tyco Electronics ADDRESS: Tyco Electronics AMP GmbH D-64625 Bensheim
D. P.L.C. NO. 2 P.L.C. NO. 2 P.L.C. NO. 2 P.L.C. NO. 2 ANGLES ON UNITS: 0	APPLICATION SPEC: PL-18488 DRAWING TOLERANCES: - FINISH: -	SIZE: A2 CAGE CODE: 00779 DRAWING NO.: 16440200 SECURITY: -	RESTRICTED TO: - SCALE: 1:1 SHEET: 4 OF: 6 REF: 2
MATERIAL: -		CUSTOMER DRAWING: -	

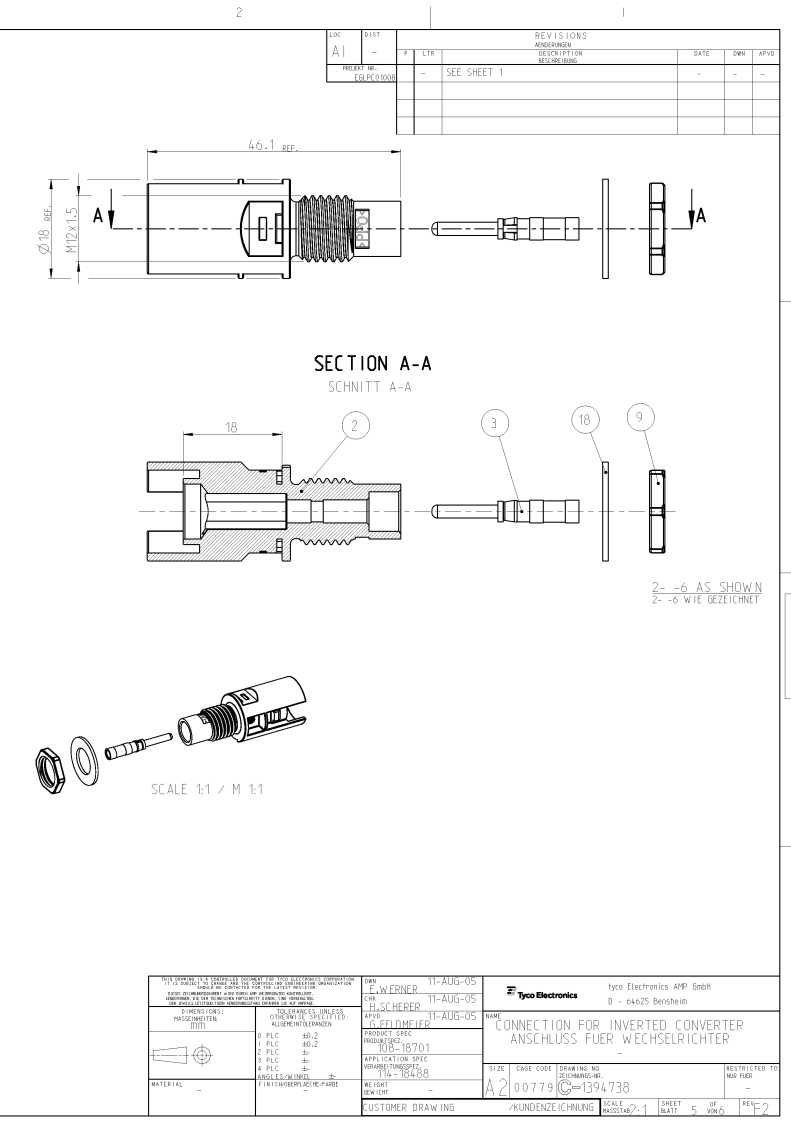
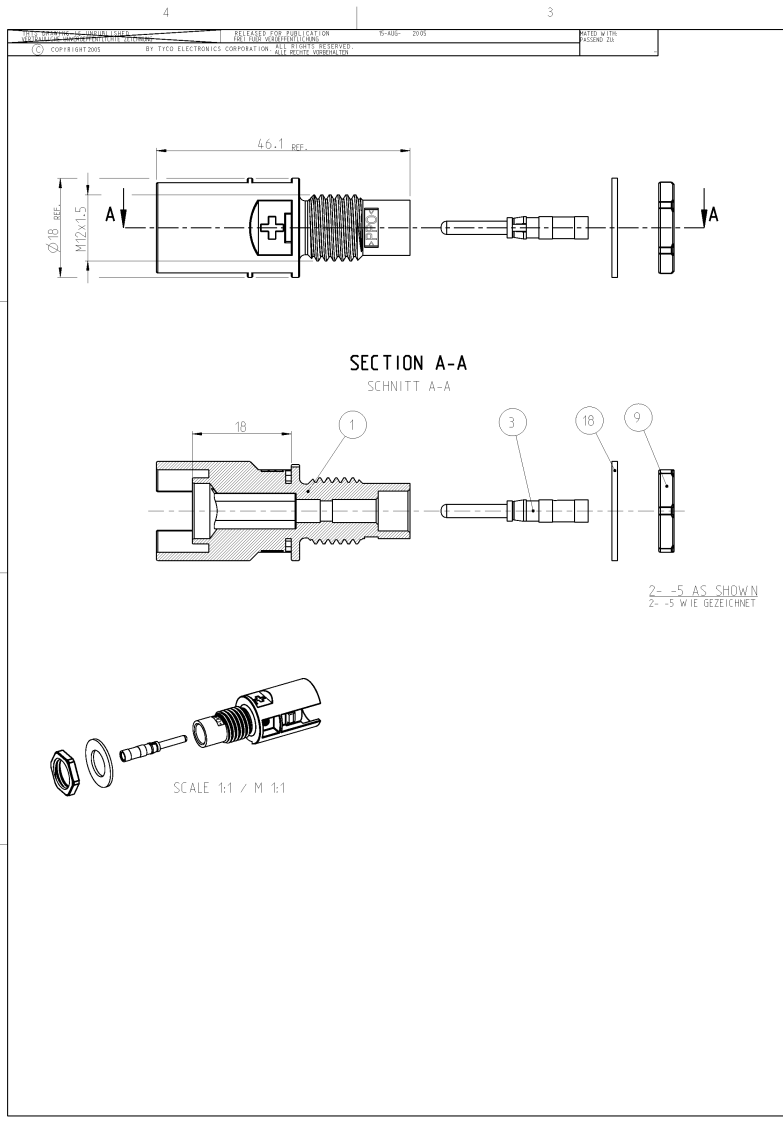

TYP: KUNDENZUGABE ZWECK: VERBUNDEN MIT ANSCHLUSSELEKTRONIK FÜR DIE VERWENDUNG IN DER VERBUNDEN MIT ANSCHLUSSELEKTRONIK ANSCHLUSSELEKTRONIK ANSCHLUSSELEKTRONIK ANSCHLUSSELEKTRONIK	ZWECK: VERBUNDEN MIT ANSCHLUSSELEKTRONIK FÜR DIE VERWENDUNG IN DER VERBUNDEN MIT ANSCHLUSSELEKTRONIK ANSCHLUSSELEKTRONIK ANSCHLUSSELEKTRONIK ANSCHLUSSELEKTRONIK	DWN 11-AUG-05 J. WERNER 11-AUG-05 J. SCHNEIDER 11-AUG-05 J. FLEMMER 11-AUG-05	Tyco Electronics Tyco Electronics AMP GmbH D - 64625 Bensheim
NAME CONNECTION FOR INVERTED CONVERTER ANSCHLUSS FÜR WECHSELRICHTER			REVISIONS 11-AUG-05 11-AUG-05 11-AUG-05
MATERIAL -	FINISCHWARZ/BLACK/NOIR	APPLICATION SPEC 100-18701 DRAWING NO. 116-18488 SCALE -	SIZE A2 CAGE CODE 00779 DRAWING NO. 1394738
CUSTOMER DRAWING		KUNDENZUGABE	SCALE 1:1 SHEET 5 OF 6 REF 2

4

3

DATE OF THIS DRAWING: 25-MAR-10	DATE OF PREVIOUS EDITION: 25-MAR-10	DATE OF THIS EDITION: 25-MAR-10
BY: TYPHO ELECTRONICS CORPORATION	BY: TYPHO ELECTRONICS CORPORATION	BY: TYPHO ELECTRONICS CORPORATION
ALL RIGHTS RESERVED	ALL RIGHTS RESERVED	ALL RIGHTS RESERVED
© COPYRIGHT 2002	© COPYRIGHT 2002	© COPYRIGHT 2002

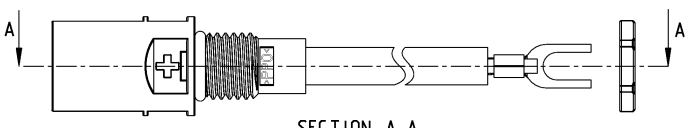

SECTION A-A
SCHNITT A-A

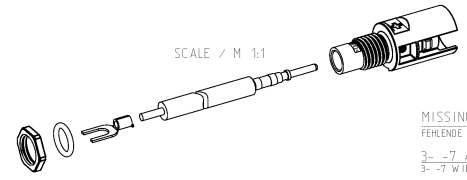
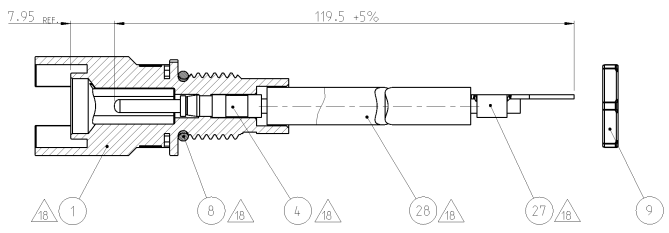

SCALE / M 1:1

MISSING DIMENSION SEE 2- -6
FEHLENDE MASSE SIEHE 2- -6
3- -7 AS SHOWN
3- -7 WIE GEZEICHNET

- ▲ ITEM NO. 8, 4, 24 PRE-ASSEMBLED WITH ITEM NO. 1 AND 25 OR ITEM NO. 2 AND 26.
- ▲ ITEM NO. 8, 4, 27 PRE-ASSEMBLED WITH ITEM NO. 1 AND 28 OR ITEM NO. 2 AND 29.
- ▲ 100 PIECES ITEM NO. 9 NUT M12x1.5 PACKED IN ITEM NO. 13 MINIGRIP BAG AND ENCLOSED IN ITEM NO. 14 CORD TENSIONING BAG.
- ▲ 100 PIECES OF PRE-ASSEMBLED CONNECTORS AND NUT 12x1.5 IN MINIGRIP BAG ▲ PACKED IN ITEM NO. 14 CORD TENSIONING BAG.

2

1

LOC.	QTY.	REV.	DESCRIPTION	DATE	BY	APPD.
A1	-	1	SEE SHEET 1	-	-	-

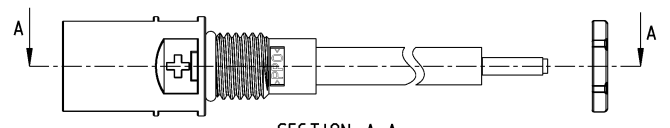

SECTION A-A
SCHNITT A-A

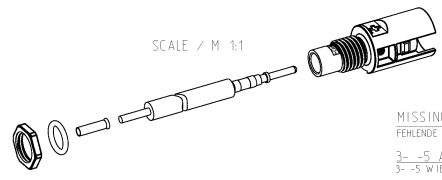
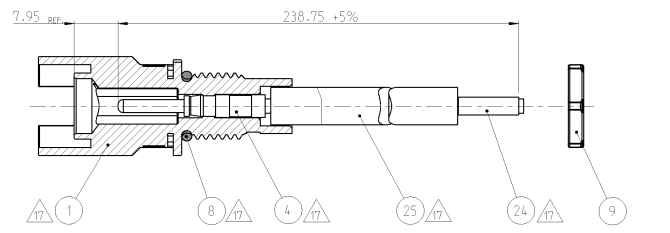

SCALE / M 1:1

MISSING DIMENSION SEE 2- -6
FEHLENDE MASSE SIEHE 2- -6
3- -5 AS SHOWN
3- -5 WIE GEZEICHNET

- ▲ POS. 8, 4, 24 VORMONTIERT MIT POS. 1 UND 25 ODER POS. 2 UND 26.
- ▲ POS. 8, 4, 27 VORMONTIERT MIT POS. 1 UND 28 ODER POS. 2 UND 29.
- ▲ 100 STÜCKE POS. 9 MUTTER M12x1.5 VERPACKT IN POS. 13 MINIGRIP-BEUTEL UND IN POS. 14 KORDELZUG-BEUTEL BEIGELEGT.
- ▲ 100 STÜCKE DER VORMONTIERTEN STECKVERBINDER UND MUTTERN IM MINIGRIP-BEUTEL ▲ IN POS. 14 KORDELZUG-BEUTEL VERPACKT.

TYPHO ELECTRONICS CORPORATION 10000 W. 10TH AVENUE, SUITE 100 DENVER, CO 80202-2299 TEL: 303.733.1000 FAX: 303.733.1001 WWW.TYPHO.COM		DATE: 25-MAR-10 DRAWN: FE. REISS CHECKED: 25-MAR-10 APPROVED: A. W. FISHER PRODUCTION: 00-18701 APPLICATION SPEC: T16-18488 DRAWING NO.: 16-18488 REVISION: - CUSTOMER DRAWING	TYPHO Electronics APW GmbH D - 64625 Bensheim NAME: CONNECTION FOR INVERTED CONVERTER ANSCHLUSS FUER WECHSELRICHTER SIZE: A2 CAGE CODE: 00779 DRAWING NO.: 1394738 SCALE: 1:1 SHEET: 6 OF: 6 REF: 2
---	--	--	---