

# Thin-Film RF/Microwave Capacitor Technology

## Accu-P® Series

### Thin-Film Technology



#### THE IDEAL CAPACITOR

The non-ideal characteristics of a real capacitor can be ignored at low frequencies. Physical size imparts inductance to the capacitor and dielectric and metal electrodes result in resistive losses, but these often are of negligible effect on the circuit. At the very high frequencies of radio communication (>100MHz) and satellite systems (>1GHz), these effects become important. Recognizing that a real capacitor will exhibit inductive and resistive impedances in addition to capacitance, the ideal capacitor for these high frequencies is an ultra low loss component which can be fully characterized in all parameters with total repeatability from unit to unit.

Until recently, most high frequency/microwave capacitors were based on fired-ceramic (porcelain) technology. Layers of ceramic dielectric material and metal alloy electrode paste are interleaved and then sintered in a high temperature oven. This technology exhibits component variability in dielectric quality (losses, dielectric constant and insulation resistance), variability in electrode conductivity and variability in physical size (affecting inductance). An alternate thin-film technology has been developed which virtually eliminates these variances. It is this technology which has been fully incorporated into Accu-P® and Accu-P® to provide high frequency capacitors exhibiting truly ideal characteristics.

The main features of Accu-P® may be summarized as follows:

- High purity of electrodes for very low and repeatable ESR.
- Highly pure, low-K dielectric for high breakdown field, high insulation resistance and low losses to frequencies above 40GHz.
- Very tight dimensional control for uniform inductance, unit to unit.
- Very tight capacitance tolerances for high frequency signal applications.

This accuracy sets apart these Thin-Film capacitors from ceramic capacitors so that the term Accu has been employed as the designation for this series of devices, an abbreviation for "accurate."

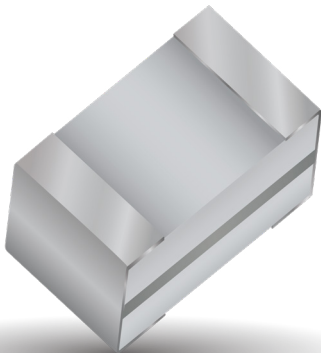

#### THIN-FILM TECHNOLOGY

Thin-film technology is commonly used in producing semiconductor devices. In the last two decades, this technology has developed tremendously, both in performance and in process control. Today's techniques enable line definitions of below 1µm, and the controlling of thickness of layers at 100Å (10-2µm). Applying this technology to the manufacture of capacitors has enabled the development of components where both electrical and physical properties can be tightly controlled.

The thin-film production facilities at AVX consist of:

- Class 1000 clean rooms, with working areas under laminar-flow hoods of class 100, (below 100 particles per cubic foot larger than 0.5µm).
- High vacuum metal deposition systems for high-purity electrode construction.
- Photolithography equipment for line definition down to 2.0µm accuracy.
- Plasma-enhanced CVD for various dielectric depositions (CVD=Chemical Vapor Deposition).
- High accuracy, microprocessor-controlled dicing saws for chip separation.
- High speed, high accuracy sorting to ensure strict tolerance adherence.

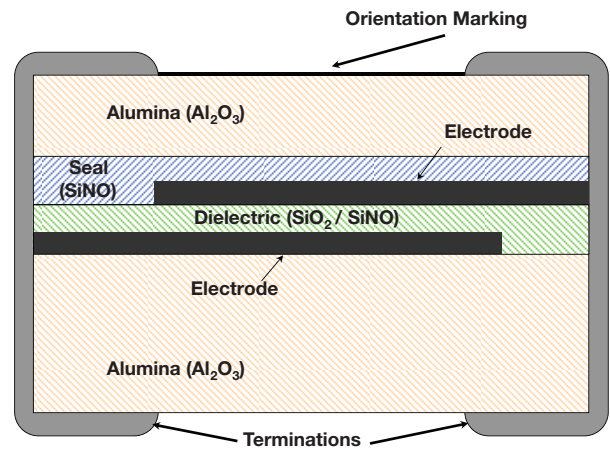

ACCU-P® CAPACITOR STRUCTURE

# Thin-Film RF/Microwave Capacitor Technology

## Accu-P® Series

### Thin-Film Technology



#### ACCU-P® TECHNOLOGY

The use of very low-loss dielectric materials, silicon dioxide and silicon oxynitride, in conjunction with highly conductive electrode metals results in low ESR and high Q. These high-frequency characteristics change at a slower rate with increasing frequency than for ceramic microwave capacitors.

Because of the thin-film technology, the above-mentioned frequency characteristics are obtained without significant compromise of properties required for surface mounting.

The main Accu-P® properties are:

- Internationally agreed sizes with excellent dimensional control.
- Ultra small size chip capacitors (1005) are available.
- Ultra tight capacitance tolerances.
- Low ESR at VHF, UHF and microwave frequencies.
- Enhanced RF power handling capability.
- High stability with respect to time, temperature, frequency and voltage variation.
- Nickel/solder-coated terminations to provide excellent solderability and leach resistance.

#### ACCU-P® FEATURES

Accu-P® meets the fast-growing demand for low-loss (high-Q) capacitors for use in surface mount technology especially for the mobile communications market, such as cellular radio of 450 and 900 MHz, UHF walkie-talkies, UHF cordless telephones to 2.3 GHz, low noise blocks at 11-12.5 GHz and for other VHF, UHF and microwave applications.

Accu-P® is currently unique in its ability to offer very low capacitance values (0.05pF) and very tight capacitance tolerances ( $\pm 0.01$ pF).

- The RF power handling capability of the Accu-P® allows for its usage in both small signal and RF power applications.
- Thin Film Technology guarantees minimal batch to batch variability of parameters at high frequency.
- Inspection test and quality control procedures in accordance with ISO 9001, CECC, IECQ and USA MIL Standards yield products of the highest quality.
- Hand soldering Accu-P®: Due to their construction utilizing relatively high thermal conductivity materials, Accu-P's have become the preferred device in R & D labs and production environments where hand soldering is used.

#### APPLICATIONS

- Cellular Communications
- CT2/PCN (Cordless Telephone/Personal Comm. Networks)
- Satellite TV
- Cable TV
- GPS (Global Positioning Systems)
- Vehicle Location Systems
- Vehicle Alarm Systems
- Paging
- Military Communications
- Radar Systems
- Video Switching
- Test & Measurements
- Filters
- VCO's
- Matching Networks
- RF Amplifiers

#### APPROVALS

- ISO 9001
- IATF 16949:2016

# Thin-Film RF/Microwave Capacitor Technology

## Accu-P® Series

### Thin-Film Chip Capacitors

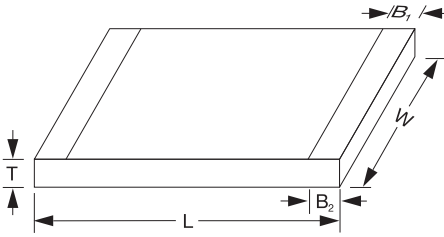

### ACCU-P® (SIGNAL AND POWER TYPE CAPACITORS)

	01005*	0201*	0402*	0603*	0805*	1210
<b>L</b>	0.405±0.020 (0.016±0.001)	0.60±0.05 (0.023±0.002)	1.00±0.1 (0.039±0.004)	1.60±0.1 (0.063±0.004)	2.01±0.1 (0.079±0.004)	3.02±0.1 (0.119±0.004)
<b>W</b>	0.215±0.020 (0.0085±0.002)	0.325±0.050 (0.0128±0.002)	0.55±0.07 (0.022±0.003)	0.81±0.1 (0.032±0.004)	1.27±0.1 (0.050±0.004)	2.5±0.1 (0.100±0.004)
<b>T</b>	0.145±0.020 (0.006±0.001)	0.225±0.050 (0.009±0.002)	0.40±0.1 (0.016±0.004)	0.63±0.1 (0.025±0.004)	0.93±0.2 (0.036±0.008)	0.93±0.2 (0.036±0.008)
<b>B1</b>	0.00 <sup>+0.1</sup> <sub>-0.0</sub> (0.004 <sup>+0.004</sup> <sub>-0.000</sub> )	0.10±0.10 (0.004±0.004)	(0.0 <sup>+0.1</sup> <sub>-0.0</sub> ) (0.00 <sup>+0.004</sup> <sub>-0.000</sub> )	0.35±0.15 (0.014±0.006)	0.30±0.1 (0.012±0.004)	0.43±0.1 (0.017±0.004)
<b>B2</b>	0.15±0.05 (0.000±0.002)	0.15±0.05 (0.006±0.002)	0.20±0.1 (0.008±0.004)	0.35±0.15 (0.014±0.006)	0.30±0.1 (0.012±0.004)	0.43±0.1 (0.017±0.004)

\*Mount Black Side Up

DIMENSIONS: millimeters (inches)

### HOW TO ORDER

<b>0402</b> T	<b>3</b> T	<b>J</b> T	<b>4R7</b> T	<b>A</b> T	<b>B</b> T	<b>S</b> T	<b>TR</b> T	<b>\500</b> T
<b>Size</b> C005 0201 0402 0603 0805 1210*	<b>Voltage</b> 2 = 200V 1 = 100V 5 = 50V 3 = 25V Y = 16V Z = 10V	<b>Temperature Coefficient (1)</b> J = 0±30ppm/°C (-55°C to +125°C) K = 0±60ppm/°C (-55°C to +125°)	<b>Capacitance</b> Capacitance expressed in pF. (2 significant digits + number of zeros) <b>for values &lt;10pF,</b> letter R denotes decimal point. Example: 68pF = 680 8.2pF = 8R2	<b>Tolerance</b> <b>for Cs&lt;2.0pF*</b> Z = ±0.01pF P = ±0.02pF Q = ±0.03pF A = ±0.05pF B = ±0.1pF C = ±0.25pF <b>for Cs&lt;3.0pF</b> Q = ±0.03pF A = ±0.05pF B = ±0.1pF C = ±0.25pF <b>for Cs&lt;5.6pF</b> A = ±0.05pF B = ±0.1pF C = ±0.25pF <b>for 5.6pF&lt;C&lt;10pF</b> B = ±0.1pF C = ±0.25pF D = ±0.5pF <b>for C≥10pF</b> F = ±1% G = ±2% J = ±5%	<b>Specification Code</b> B = Accu-P® technology	<b>Termination Code</b> W=Nickel/Solder Coated <b>Accu-P® 0402</b> Sn90, Pb10*** T=Nickel/High Temperature Solder Coated <b>Accu-P® 0805**, 1210**</b> Sn96, Ag4 Nickel/Solder Coated <b>Accu-P® 0603***</b> Sn63, Pb37 **S=Nickel/Lead Free Solder Coated <b>Accu-P® 1005, 0201 0402, 0603</b> Sn100	<b>Packaging Code</b> TR = Tape & Reel	<b>Option</b>

\*\*RoHS compliant  
\*\*\* Not RoHS Compliant

The following 3 digit capacitance codes should be used for ordering AVX Accu-P® capacitors	
CAPACITANCE CODE	EXAMPLE
0.00 to 0.99pF Rxx	0.15pF = 04023JR15ABSTR
1.00 to 1.99pF Axx	1.55pF = 04023JA55PBSTR
2.00 to 2.99pF Bxx	2.85pF = ....B85...
3.00 to 3.99pF Cxx	3.85pF = ....C85...
4.00 to 4.99pF Dxx	4.85pF = ....D85...
5.00 to 5.99pF Exx	5.85pF = ....E85...
6.00 to 6.99pF Fxx	6.85pF = ....F85...
7.00 to 7.99pF Gxx	7.85pF = ....G85...
8.00 to 8.99pF Hxx	8.85pF = ....H85...
9.00 to 9.99pF Jxx	9.85pF = ....J85...
10.0 to 19.9pF Kxx	13.8pF = ....K38...
20.0 to 29.9pF Lxx	22.5pF = ....L25...
30.0 to 39.9pF Mxx	33.8pF = ....M38...
40.0 to 49.9pF Nxx	43.5pF = ....N35...

(1) TC's shown are per EIA/IEC Specifications.  
\* Tolerances as tight as ±0.01pF are available.  
Please consult the factory.



For RoHS compliant products, please select correct termination style.

### ELECTRICAL SPECIFICATIONS

Operating and Storage Temperature Range	-55°C to +125°C
Temperature Coefficients (1)	0 ± 30ppm/°C dielectric code "J" / 0 ± 60ppm/°C dielectric code "K"
Capacitance Measurement	1 MHz, 1 Vrms
Insulation Resistance (IR)	≥1011 Ohms (≥10 <sup>10</sup> Ohms for 0201 and 0402 size)
Proof Voltage	2.5 U <sub>R</sub> for 5 secs.
Aging Characteristic	Zero
Dielectric Absorption	0.01%



# Thin-Film RF/Microwave Capacitor Technology

## Accu-P® Series

### Single and Power Type Capacitors



#### TEMP. COEFFICIENT CODE

"J" = 0±30PPM/°C (-55°C TO +125°C)<sup>(2)</sup> "K" = 0±60PPM/°C (-55°C TO +125°C)<sup>(2)</sup>

Size		C005					0201					0402					0603				0805			1210	
Size Code	Voltage	16	100	50	25	16	10	200	100	50	25	16	10	200	100	50	25	100	50	25	100	50			
Cap in pF	Cap code																								
0.1	— 0R1																								
0.2	— 0R2																								
0.3	— 0R3																								
0.4	— 0R4																								
0.5	— 0R5																								
0.6	— 0R6																								
0.7	— 0R7																								
0.8	— 0R8																								
0.9	— 0R9																								
1.0	— 1R0																								
1.1	— 1R1																								
1.2	— 1R2																								
1.3	— 1R3																								
1.4	— 1R4																								
1.5	— 1R5																								
1.6	— 1R6																								
1.7	— 1R7																								
1.8	— 1R8																								
1.9	— 1R9																								
2.0	— 2R0																								
2.1	— 2R1																								
2.2	— 2R2																								
2.3	— 2R3																								
2.4	— 2R4																								
2.5	— 2R5																								
2.6	— 2R6																								
2.7	— 2R7																								
2.8	— 2R8																								
2.9	— 2R9																								
3.0	— 3R0																								
3.1	— 3R1																								
3.2	— 3R2																								
3.3	— 3R3																								
3.4	— 3R4																								
3.5	— 3R5																								
3.6	— 3R6																								
3.7	— 3R7																								
3.8	— 3R8																								
3.9	— 3R9																								
4.0	— 4R0																								
4.1	— 4R1																								
4.2	— 4R2																								
4.3	— 4R3																								
4.4	— 4R4																								
4.5	— 4R5																								
4.6	— 4R6																								
4.7	— 4R7																								
5.1	— 5R1																								
5.6	— 5R6																								
6.2	— 6R2																								
6.8	— 6R8																								
7.5	— 7R5																								
8.2	— 8R2																								
9.1	— 9R1																								
10.0	— 100																								
11.0	— 110																								
12.0	— 120																								
13.0	— 130																								
14.0	— 140																								
15.0	— 150																								
16.0	— 160																								
17.0	— 170																								
18.0	— 180																								
19.0	— 190																								
20.0	— 200																								
21.0	— 210																								
22.0	— 220																								
24.0	— 240																								
27.0	— 270																								
30.0	— 300																								
33.0	— 330																								
39.0	— 390																								
47.0	— 470																								
56.0	— 560																								
68.0	— 680																								

(1) For capacitance values higher than listed in table, please consult factory.

(2) TC shown is per EIA/IEC Specifications.

These values are produced with "K" temperature coefficient code only.

Intermediate values are available within the indicated range.



The Important Information/Disclaimer is incorporated in the catalog where these specifications came from or available online at [www.avx.com/disclaimer/](http://www.avx.com/disclaimer/) by reference and should be reviewed in full before placing any order.

# Thin-Film RF/Microwave Capacitor Technology

## Accu-P® Series

### 0201 Typical Electrical Tables



Capacitance @ 1MHz and Tolerance		Self Resonance Frequency (GHz) Typ.	Q Standard Value @ 1GHz		Frequency 900MHz			Frequency 1900MHz			Frequency 2400MHz		
C (pF)	Tol.		Typ.	Min.	C(eff) (pF) Typ.	Q Typ.	ESR (mOhm) Typ.	C(eff) (pF) Typ.	Q Typ.	ESR (mOhm) Typ.	C(eff) (pF) Typ.	Q Typ.	ESR (mOhm) Typ.
0.05	±0.02	20.9	599	402	0.055	650	3220	0.056	265	4010	0.057	195	4450
0.1	±0.02	19.4	574	316	0.110	614	2682	0.112	246	3036	0.113	188	3113
0.15	±0.02	17.9	510	280	0.163	550	2087	0.166	220	2404	0.168	170	2441
0.2	±0.02	16.4	445	245	0.216	520	1693	0.220	210	1971	0.223	160	1970
0.25	±0.02	15.5	436	240	0.262	510	1371	0.268	204	1604	0.272	153	1646
0.3	±0.02	14.6	427	235	0.309	500	1149	0.316	199	1337	0.320	146	1421
0.35	±0.02	14.1	423	232	0.360	494	1001	0.369	196	1177	0.374	144	1265
0.4	±0.02	12.5	418	230	0.411	489	874	0.421	193	1038	0.427	142	1129
0.45	±0.02	11.9	413	227	0.461	484	819	0.473	191	972	0.481	140	1066
0.5	±0.02	11.3	408	224	0.512	478	765	0.526	188	906	0.535	138	1003
0.55	±0.02	10.9	403	222	0.563	473	710	0.578	186	840	0.588	137	940
0.6	±0.02	10.4	398	219	0.614	468	667	0.631	183	791	0.642	135	882
0.65	±0.02	10.0	394	217	0.664	462	624	0.683	181	742	0.695	133	825
0.7	±0.02	9.5	389	214	0.715	457	580	0.735	178	693	0.749	131	767
0.75	±0.02	9.3	384	211	0.766	452	557	0.788	176	664	0.802	129	729
0.8	±0.02	9.1	379	209	0.817	446	534	0.840	173	635	0.856	127	692
0.85	±0.02	8.9	374	206	0.868	441	511	0.893	171	606	0.909	126	654
0.9	±0.02	8.8	370	203	0.918	436	487	0.945	168	577	0.963	124	616
0.95	±0.02	8.6	365	201	0.969	430	464	0.998	166	548	1.016	122	579
1	±0.02	8.4	360	198	1.020	425	441	1.050	163	519	1.070	120	541
1.05	±0.02	8.2	358	197	1.078	421	426	1.112	161	502	1.134	119	523
1.1	±0.02	8.0	355	195	1.135	418	410	1.173	159	486	1.199	117	505
1.15	±0.02	7.8	353	194	1.193	414	395	1.235	157	469	1.263	116	488
1.2	±0.02	7.6	350	193	1.251	411	379	1.296	155	452	1.327	115	470
1.25	±0.02	7.5	348	191	1.308	407	364	1.358	153	436	1.392	114	452
1.3	±0.02	7.4	345	190	1.366	403	348	1.419	151	419	1.456	112	434
1.35	±0.02	7.3	343	189	1.424	400	333	1.481	149	402	1.520	111	416
1.4	±0.02	7.2	340	187	1.481	396	317	1.542	147	386	1.585	110	398
1.45	±0.02	7.1	338	186	1.539	393	302	1.604	145	369	1.649	109	381
1.5	±0.02	7.0	335	184	1.597	389	287	1.665	144	353	1.713	107	363
1.55	±0.02	6.8	332	183	1.642	386	282	1.714	142	347	1.764	106	358
1.6	±0.02	6.7	330	181	1.687	382	277	1.762	141	342	1.815	105	352
1.65	±0.02	6.6	327	180	1.732	378	272	1.810	140	337	1.866	104	347
1.7	±0.02	6.5	324	178	1.777	375	267	1.859	138	331	1.917	103	342
1.75	±0.02	6.4	321	176	1.822	371	262	1.907	137	326	1.968	102	337
1.8	±0.02	6.3	318	175	1.866	367	257	1.955	136	321	2.018	101	331
1.85	±0.02	6.2	315	173	1.911	364	252	2.003	134	316	2.069	100	326
1.9	±0.02	6.2	312	172	1.956	360	247	2.052	133	310	2.120	99	321
1.95	±0.02	6.1	309	170	2.001	357	242	2.100	132	305	2.171	98	316
2	±0.03	6.0	306	168	2.046	353	237	2.148	131	300	2.222	97	310
2.1	±0.03	5.9	301	166	2.150	348	232	2.263	128	293	2.344	95	303
2.2	±0.03	5.7	296	163	2.254	343	227	2.377	125	287	2.467	93	296
2.3	±0.03	5.6	292	160	2.358	337	222	2.491	122	281	2.590	91	289
2.4	±0.03	5.5	287	158	2.462	332	217	2.606	120	274	2.712	89	282
2.5	±0.03	5.4	282	155	2.566	327	212	2.720	117	268	2.835	87	275
2.6	±0.03	5.3	277	152	2.670	322	207	2.834	114	262	2.958	85	268
2.7	±0.03	5.2	272	150	2.773	317	202	2.949	112	255	3.080	83	261
2.8	±0.03	5.1	269	148	2.878	312	199	3.066	110	252	3.209	81	258
2.9	±0.03	5.0	265	146	2.983	308	196	3.184	108	248	3.337	80	254
3	±0.03	4.9	261	144	3.088	304	193	3.301	106	245	3.465	78	251
3.1	±0.05	4.8	257	141	3.192	299	190	3.419	105	241	3.593	77	247
3.2	±0.05	4.7	253	139	3.297	295	187	3.536	103	238	3.722	76	244
3.3	±0.05	4.6	250	137	3.402	291	185	3.654	101	234	3.850	74	240
3.4	±0.05	4.6	246	135	3.506	286	182	3.771	99	231	3.978	73	237
3.5	±0.05	4.5	242	133	3.611	282	179	3.889	98	227	4.107	71	233
3.6	±0.05	4.5	238	131	3.716	278	176	4.006	96	224	4.235	70	230
3.7	±0.05	4.4	234	129	3.820	273	173	4.124	94	220	4.363	69	226
3.8	±0.05	4.4	230	127	3.925	269	170	4.241	92	217	4.492	67	223



# Thin-Film RF/Microwave Capacitor Technology

## Accu-P® Series

### 0201 Typical Electrical Tables



Capacitance @ 1MHz and Tolerance		Self Resonance Frequency (GHz) Typ.	Q Standard Value @ 1GHz		Frequency 900MHz			Frequency 1900MHz			Frequency 2400MHz		
C (pF)	Tol.		Typ.	Min.	C(eff) (pF) Typ.	Q Typ.	ESR (mOhm) Typ.	C(eff) (pF) Typ.	Q Typ.	ESR (mOhm) Typ.	C(eff) (pF) Typ.	Q Typ.	ESR (mOhm) Typ.
3.9	±0.05	4.3	227	125	4.030	265	167	4.359	91	213	4.620	66	219
4	±0.05	4.3	224	123	4.138	262	165	4.484	89	210	4.760	65	216
4.1	±0.05	4.2	222	122	4.247	259	162	4.610	88	207	4.901	64	213
4.2	±0.05	4.2	220	121	4.356	257	159	4.735	87	204	5.041	63	210
4.3	±0.05	4.1	218	120	4.464	254	157	4.860	86	201	5.181	62	207
4.4	±0.05	4.1	216	119	4.573	252	154	4.986	85	198	5.322	61	204
4.5	±0.05	4.0	214	118	4.682	249	152	5.111	83	195	5.462	60	201
4.6	±0.05	4.0	212	116	4.790	246	149	5.237	82	192	5.602	59	198
4.7	±0.05	3.9	209	115	4.899	244	147	5.362	81	189	5.743	58	195
5.1	±0.05	3.8	201	110	5.334	233	136	5.863	76	178	6.304	54	183
5.6	±0.05	3.6	190	105	5.877	220	124	6.490	70	163	7.006	49	168
6.2	±0.1	3.5	177	97	6.488	208	126	7.290	65	167	7.993	45	174
6.8	±0.1	3.3	164	90	7.100	195	128	8.090	60	171	8.980	41	179
7.5	±0.1	3.2	153	84	7.901	182	125	9.129	56	166	10.27	38	173
8.2	±0.1	3.0	142	78	8.701	168	121	10.17	52	160	11.56	34	167
9.1	±0.1	2.9	135	74	9.676	159	118	11.57	49	154	13.49	32	161
10	±1%	2.8	128	70	10.65	151	114	12.96	45	148	15.41	29	155
11	±1%	2.7	120	66	11.73	141	110	14.52	42	142	17.55	27	148
12	±1%	2.5	112	62	12.82	132	105	16.07	39	135	19.68	24	141
13	±1%	2.4	105	58	13.92	124	104	17.82	36	135	22.38	22	142
14	±1%	2.4	98	54	15.02	116	103	19.57	32	135	25.08	19	142
15	±1%	2.3	91	50	16.12	108	102	21.32	29	135	27.78	17	143
16	±1%	2.2	86	47	17.37	102	103	24.04	27	135	NA	NA	NA
17	±1%	2.2	81	44	18.63	96	105	26.76	25	136	NA	NA	NA
18	±1%	2.1	76	42	19.88	90	106	29.48	23	136	NA	NA	NA
19	±1%	2.1	71	39	21.14	83	108	32.20	21	136	NA	NA	NA
20	±1%	2.1	65	36	22.39	77	109	34.92	19	136	NA	NA	NA
22	±1%	2.0	55	30	24.90	65	112	40.36	15	137	NA	NA	NA



The Important Information/Disclaimer is incorporated in the catalog where these specifications came from or available online at [www.avx.com/disclaimer/](http://www.avx.com/disclaimer/) by reference and should be reviewed in full before placing any order.

# Thin-Film RF/Microwave Capacitor Technology

## Accu-P® Series

### 0402 Typical Electrical Tables



Capacitance @ 1MHz and Tolerance		Self Resonance Frequency (GHz) Typ.	Q Standard Value @ 1GHz		Frequency 900MHz			Frequency 1900MHz			Frequency 2400MHz		
C (pF)	Tol.		Typ.	Min.	C(eff) (pF) Typ.	Q Typ.	ESR (mOhm) Typ.	C(eff) (pF) Typ.	Q Typ.	ESR (mOhm) Typ.	C(eff) (pF) Typ.	Q Typ.	ESR (mOhm) Typ.
0.05	±0.02	20.9	856	471	0.06	881	1411	0.06	562	1216	0.06	498	983
0.1	±0.02	19.4	848	466	0.11	873	1316	0.11	554	1115	0.11	490	914
0.15	±0.02	17.9	840	462	0.16	866	1222	0.16	547	1013	0.16	482	845
0.2	±0.02	16.4	832	457	0.21	858	1128	0.21	539	912	0.22	474	776
0.25	±0.02	15.5	823	453	0.26	850	1033	0.27	532	810	0.27	465	707
0.3	±0.02	14.6	815	448	0.31	842	939	0.32	525	708	0.32	457	638
0.35	±0.02	14.1	807	444	0.36	834	844	0.37	517	607	0.37	449	569
0.4	±0.02	12.5	799	439	0.41	827	750	0.42	510	505	0.42	441	500
0.45	±0.02	11.9	791	435	0.46	819	667	0.47	502	458	0.48	432	453
0.5	±0.02	11.3	783	430	0.51	811	583	0.52	495	410	0.53	424	407
0.55	±0.02	10.9	774	426	0.57	803	500	0.57	487	363	0.58	416	360
0.6	±0.02	10.4	766	421	0.62	796	465	0.62	480	343	0.63	408	339
0.65	±0.02	10.0	758	417	0.67	788	431	0.67	472	322	0.68	399	317
0.7	±0.02	9.5	750	413	0.72	780	396	0.72	465	302	0.73	391	296
0.75	±0.02	9.3	746	410	0.77	776	375	0.78	456	290	0.79	381	285
0.8	±0.02	9.1	743	408	0.82	772	354	0.83	447	277	0.84	370	273
0.85	±0.02	9.0	739	406	0.87	768	334	0.88	438	265	0.89	360	262
0.9	±0.02	8.8	735	404	0.92	764	313	0.93	429	253	0.95	350	250
0.95	±0.02	8.4	732	402	0.97	760	292	0.98	420	240	1.00	339	239
1	±0.02	8.0	728	400	1.02	756	271	1.04	411	228	1.05	329	227
1.05	±0.02	7.9	725	398	1.07	752	258	1.09	406	221	1.11	323	221
1.1	±0.02	7.8	721	397	1.12	749	245	1.14	401	214	1.16	318	214
1.15	±0.02	7.6	718	395	1.17	745	232	1.20	396	207	1.22	312	208
1.2	±0.02	7.4	714	393	1.22	742	218	1.25	391	200	1.27	306	202
1.25	±0.02	7.2	711	391	1.27	738	205	1.31	386	193	1.32	301	195
1.3	±0.02	7.0	707	389	1.32	734	192	1.36	381	185	1.38	295	189
1.35	±0.02	6.9	704	387	1.37	731	179	1.41	376	178	1.43	289	183
1.4	±0.02	6.8	700	385	1.42	727	165	1.47	371	171	1.49	283	177
1.45	±0.02	6.7	697	383	1.47	724	152	1.52	366	164	1.54	278	170
1.5	±0.02	6.5	693	381	1.52	720	139	1.58	361	157	1.60	272	164
1.55	±0.02	6.5	690	379	1.56	716	135	1.62	358	153	1.65	269	159
1.6	±0.02	6.5	686	377	1.61	713	130	1.67	355	148	1.70	267	155
1.65	±0.02	6.5	683	375	1.66	709	126	1.72	352	143	1.76	264	150
1.7	±0.02	6.4	679	373	1.71	705	122	1.77	349	139	1.81	261	146
1.75	±0.02	6.3	676	372	1.75	702	118	1.82	347	134	1.86	259	141
1.8	±0.02	6.2	672	370	1.80	698	113	1.87	344	130	1.92	256	137
1.85	±0.02	6.1	669	368	1.85	694	109	1.92	341	125	1.97	253	132
1.9	±0.02	6.0	665	366	1.90	690	105	1.97	338	121	2.02	251	128
1.95	±0.02	5.9	662	364	1.94	687	101	2.01	335	116	2.08	248	123
2	±0.03	5.7	658	362	1.99	683	96	2.06	332	112	2.13	245	119
2.1	±0.03	5.4	651	358	2.10	676	93	2.18	326	108	2.26	241	115
2.2	±0.03	5.1	643	354	2.21	669	89	2.30	321	104	2.38	236	112
2.3	±0.03	5.0	636	350	2.31	662	85	2.42	315	101	2.51	231	109
2.4	±0.03	4.9	629	346	2.42	656	81	2.54	309	97	2.64	226	106
2.5	±0.03	4.7	622	342	2.53	649	77	2.65	303	94	2.76	221	102
2.6	±0.03	4.6	614	338	2.64	642	74	2.77	298	90	2.89	216	99
2.7	±0.03	4.5	607	334	2.75	635	70	2.89	292	86	3.02	211	96
2.8	±0.03	4.5	600	330	2.85	628	68	3.01	288	83	3.15	207	92
2.9	±0.03	4.4	592	326	2.95	621	66	3.13	283	80	3.28	203	88
3	±0.03	4.4	585	322	3.06	614	64	3.24	279	76	3.41	200	84
3.1	±0.05	4.4	578	318	3.16	607	62	3.36	274	73	3.54	196	80
3.2	±0.05	4.3	570	314	3.27	600	60	3.48	270	70	3.67	192	76
3.3	±0.05	4.3	563	310	3.37	593	58	3.60	265	67	3.80	188	72
3.4	±0.05	4.3	556	306	3.47	586	57	3.71	261	63	3.93	184	68
3.5	±0.05	4.2	548	302	3.58	579	55	3.83	256	60	4.06	180	64
3.6	±0.05	4.2	541	298	3.68	572	53	3.95	252	57	4.19	177	60
3.7	±0.05	4.1	534	294	3.78	565	51	4.06	247	54	4.32	173	56
3.8	±0.05	4.0	526	289	3.89	558	49	4.18	243	50	4.45	169	52



# Thin-Film RF/Microwave Capacitor Technology

## Accu-P® Series

### 0402 Typical Electrical Tables



Capacitance @ 1MHz and Tolerance		Self Resonance Frequency (GHz) Typ.	Q Standard Value @ 1GHz		Frequency 900MHz			Frequency 1900MHz			Frequency 2400MHz		
C (pF)	Tol.		Typ.	Min.	C(eff) (pF) Typ.	Q Typ.	ESR (mOhm) Typ.	C(eff) (pF) Typ.	Q Typ.	ESR (mOhm) Typ.	C(eff) (pF) Typ.	Q Typ.	ESR (mOhm) Typ.
3.9	±0.05	3.9	519	285	3.99	551	47	4.30	238	47	4.58	165	48
4	±0.05	3.9	513	282	4.10	545	47	4.42	235	47	4.73	162	48
4.1	±0.05	3.8	507	279	4.20	539	47	4.55	232	46	4.87	160	48
4.2	±0.05	3.8	501	275	4.30	534	46	4.67	228	46	5.01	157	48
4.3	±0.05	3.7	495	272	4.41	528	46	4.79	225	46	5.16	154	48
4.4	±0.05	3.7	489	269	4.51	522	46	4.92	222	46	5.30	151	47
4.5	±0.05	3.6	483	265	4.61	516	46	5.04	219	45	5.44	149	47
4.6	±0.05	3.6	477	262	4.72	511	45	5.16	216	45	5.59	146	47
4.7	±0.05	3.5	471	259	4.82	505	45	5.29	213	45	5.73	143	47
5.1	±0.05	3.4	446	245	5.23	482	44	5.78	200	43	6.30	133	47
5.6	±0.05	3.3	416	229	5.75	453	43	6.40	184	42	7.02	119	46
6.2	±0.1	3.0	388	213	6.41	427	44	7.26	167	44	8.11	107	47
6.8	±0.1	2.8	360	198	7.07	400	44	8.12	150	45	9.19	95	48
7.5	±0.1	2.7	338	186	7.85	378	45	9.17	139	47	10.57	86	49
8.2	±0.1	2.6	315	173	8.62	356	45	10.22	128	48	11.95	77	50
9.1	±0.1	2.5	292	160	9.63	333	45	11.75	115	47	14.23	69	50
10	±1%	2.4	268	148	10.65	310	45	13.28	103	47	16.50	61	49
11	±1%	2.3	242	133	11.77	285	44	14.98	89	46	19.04	51	49
12	±1%	2.2	217	119	12.90	259	44	16.68	75	45	21.57	42	48
13	±1%	2.2	202	111	14.03	241	44	18.83	68	47	25.73	38	49
14	±1%	2.1	187	103	15.17	223	44	20.97	62	49	29.89	33	49
15	±1%	2.1	172	94	16.30	204	45	23.12	56	51	34.05	29	50
16	±1%	2.0	157	87	17.53	187	44	25.91	50	49	41.44	25	49
17	±1%	1.9	143	79	18.75	169	43	28.70	45	46	48.82	21	47
18	±1%	1.8	129	71	19.98	152	42	31.49	39	44	56.21	17	46
19	±1%	1.8	121	67	21.11	143	42	33.51	36	44	60.92	15	47
20	±1%	1.8	110	61	22.25	131	41	35.53	33	43	65.63	14	48
22	±1%	1.8	98	54	24.51	116	41	39.57	26	42	75.05	10	51
24	±1%	1.8	87	48	27.51	104	37	54.94	21	35	NA	NA	NA
27	±1%	1.7	70	39	32.01	85	32	77.98	13	23	NA	NA	NA
30	±1%	1.7	65	36	35.89	78	28	106.50	10	12	NA	NA	NA
33	±1%	1.7	60	33	40.05	74	27	NA	NA	NA	NA	NA	NA
36	±1%	1.7	58	32	45.13	71	28	NA	NA	NA	NA	NA	NA
39	±1%	1.7	56	31	50.21	69	28	NA	NA	NA	NA	NA	NA
43	±1%	1.6	53	29	56.98	66	29	NA	NA	NA	NA	NA	NA
47	±1%	1.6	50	28	63.75	63	30	NA	NA	NA	NA	NA	NA
51	±1%	1.6	48	26	70.53	60	31	NA	NA	NA	NA	NA	NA
56	±1%	1.6	44	24	78.99	56	33	NA	NA	NA	NA	NA	NA
58	±1%	1.6	42	23	83.54	54	34	NA	NA	NA	NA	NA	NA
68	±1%	1.6	32	18	106.28	42	40	NA	NA	NA	NA	NA	NA



The Important Information/Disclaimer is incorporated in the catalog where these specifications came from or available online at [www.avx.com/disclaimer/](http://www.avx.com/disclaimer/) by reference and should be reviewed in full before placing any order.



# Thin-Film RF/Microwave Capacitor Technology

## Accu-P® Series

### 0603 Typical Electrical Tables



Capacitance @ 1MHz and Tolerance		Self Resonance Frequency (GHz) Typ.	Q Standard Value @ 1GHz		Frequency 900MHz			Frequency 1900MHz			Frequency 2400MHz		
C (pF)	Tol.		Typ.	Min.	C(eff) (pF) Typ.	Q Typ.	ESR (mOhm) Typ.	C(eff) (pF) Typ.	Q Typ.	ESR (mOhm) Typ.	C(eff) (pF) Typ.	Q Typ.	ESR (mOhm) Typ.
0.05	±0.02	25.6	1200	660	0.06	1333	945	0.06	556	832	0.06	397	880
0.1	±0.02	18.1	1156	636	0.11	1284	675	0.11	535	628	0.11	382	667
0.15	±0.02	14.8	1111	611	0.16	1235	555	0.16	514	533	0.16	367	567
0.2	±0.02	12.8	1067	587	0.21	1185	483	0.21	494	474	0.22	353	505
0.25	±0.02	11.4	1022	562	0.26	1136	433	0.27	473	433	0.27	338	462
0.3	±0.02	10.4	978	538	0.31	1086	397	0.32	453	402	0.32	323	430
0.35	±0.02	9.7	933	513	0.36	1037	368	0.37	432	378	0.37	309	404
0.4	±0.02	9.0	889	489	0.41	988	345	0.42	412	358	0.42	294	383
0.45	±0.02	8.5	844	464	0.46	938	326	0.47	391	341	0.48	279	365
0.5	±0.02	8.1	800	440	0.51	889	310	0.52	370	327	0.53	265	350
0.55	±0.02	7.7	788	434	0.57	875	296	0.57	363	315	0.58	261	337
0.6	±0.02	7.4	777	427	0.62	860	283	0.62	356	304	0.63	258	326
0.65	±0.02	7.1	765	421	0.67	846	273	0.67	348	294	0.68	255	315
0.7	±0.02	6.8	754	414	0.72	832	263	0.72	341	285	0.73	252	306
0.75	±0.02	6.6	742	408	0.77	817	254	0.78	334	277	0.79	248	298
0.8	±0.02	6.4	730	402	0.82	803	247	0.83	326	270	0.84	245	290
0.85	±0.02	6.2	719	395	0.87	789	239	0.88	319	264	0.89	242	283
0.9	±0.02	6.0	707	389	0.92	775	233	0.93	312	258	0.95	239	277
0.95	±0.02	5.9	696	383	0.97	760	227	0.98	304	252	1.00	235	271
1	±0.02	5.7	684	376	1.019	746	216	1.061	297	242	1.101	232	260
1.05	±0.02	5.6	667	367	1.076	731	213	1.126	290	239	1.171	226	256
1.1	±0.02	5.4	649	357	1.134	717	210	1.190	282	236	1.241	220	253
1.15	±0.02	5.3	632	347	1.192	702	206	1.254	275	233	1.311	214	250
1.2	±0.02	5.2	614	338	1.250	687	203	1.318	267	230	1.381	209	247
1.25	±0.02	5.1	605	333	1.307	677	200	1.382	262	227	1.451	203	244
1.3	±0.02	5.0	596	328	1.365	667	197	1.446	257	224	1.521	197	241
1.35	±0.02	4.9	587	323	1.423	658	194	1.511	252	221	1.591	191	238
1.4	±0.02	4.8	578	318	1.481	648	190	1.575	247	218	1.661	185	235
1.45	±0.02	4.8	569	313	1.538	638	187	1.639	242	215	1.731	179	232
1.5	±0.02	4.7	560	308	1.596	628	184	1.703	237	212	1.801	173	229
1.55	±0.02	4.6	551	303	1.645	620	181	1.760	233	209	1.866	170	226
1.6	±0.02	4.5	542	298	1.694	611	178	1.817	228	206	1.930	166	222
1.65	±0.02	4.5	534	293	1.743	603	175	1.874	224	203	1.995	163	219
1.7	±0.02	4.4	525	289	1.792	595	172	1.931	219	200	2.060	159	216
1.75	±0.02	4.3	516	284	1.841	587	169	1.988	215	197	2.124	156	213
1.8	±0.02	4.2	507	279	1.890	578	166	2.045	211	194	2.189	153	209
1.85	±0.02	4.2	498	274	1.939	570	163	2.102	206	191	2.253	149	206
1.9	±0.02	4.1	490	269	1.988	562	160	2.158	202	188	2.318	146	203
1.95	±0.02	4.1	481	264	2.037	553	157	2.215	197	185	2.383	142	199
2	±0.03	4.0	472	260	2.086	545	154	2.272	193	182	2.447	139	196
2.1	±0.03	3.9	462	254	2.190	535	151	2.402	187	180	2.604	134	193
2.2	±0.03	3.8	452	249	2.295	524	148	2.532	181	177	2.761	129	191
2.3	±0.03	3.8	442	243	2.400	514	145	2.662	175	175	2.917	124	188
2.4	±0.03	3.7	433	238	2.504	503	143	2.793	168	172	3.074	118	186
2.5	±0.03	3.6	423	232	2.609	493	140	2.923	162	170	3.230	113	183
2.6	±0.03	3.6	413	227	2.714	482	137	3.053	156	167	3.387	108	181
2.7	±0.03	3.5	403	222	2.818	472	134	3.183	150	165	3.543	103	178
2.8	±0.03	3.4	395	217	2.933	463	133	3.336	147	164	3.742	100	177
2.9	±0.03	3.4	388	213	3.047	453	131	3.489	144	162	3.940	97	175
3	±0.03	3.3	380	209	3.162	444	130	3.642	140	161	4.139	95	174
3.1	±0.05	3.2	372	205	3.276	435	129	3.795	137	160	4.337	92	172
3.2	±0.05	3.2	365	201	3.391	425	127	3.947	134	159	4.536	89	171
3.3	±0.05	3.1	357	196	3.506	416	126	4.100	131	157	4.734	86	169
3.4	±0.05	3.1	349	192	3.620	407	125	4.253	128	156	4.933	84	168
3.5	±0.05	3.1	342	188	3.735	397	123	4.406	125	155	5.131	81	166
3.6	±0.05	3.0	334	184	3.849	388	122	4.559	121	154	5.330	78	165
3.7	±0.05	3.0	326	179	3.964	379	121	4.712	118	152	5.528	75	164
3.8	±0.05	3.0	318	175	4.078	369	119	4.865	115	151	5.727	73	162



# Thin-Film RF/Microwave Capacitor Technology

## Accu-P® Series

### 0603 Typical Electrical Tables



Capacitance @ 1MHz and Tolerance		Self Resonance Frequency (GHz) Typ.	Q Standard Value @ 1GHz		Frequency 900MHz			Frequency 1900MHz			Frequency 2400MHz		
C (pF)	Tol.		Typ.	Min.	C(eff) (pF) Typ.	Q Typ.	ESR (mOhm) Typ.	C(eff) (pF) Typ.	Q Typ.	ESR (mOhm) Typ.	C(eff) (pF) Typ.	Q Typ.	ESR (mOhm) Typ.
3.9	±0.05	2.9	311	171	4.193	360	118	5.018	112	150	5.925	70	161
4	±0.05	2.9	307	169	4.301	355	117	5.188	110	149	6.188	68	160
4.1	±0.05	2.8	303	167	4.410	351	116	5.358	108	148	6.450	67	159
4.2	±0.05	2.8	299	164	4.518	347	116	5.528	106	148	6.713	65	158
4.3	±0.05	2.7	295	162	4.627	342	115	5.698	104	147	6.975	64	157
4.4	±0.05	2.7	291	160	4.735	338	114	5.867	102	146	7.238	62	157
4.5	±0.05	2.7	287	158	4.843	333	113	6.037	100	146	7.500	61	156
4.6	±0.05	2.6	283	156	4.952	329	112	6.207	98	145	7.763	59	155
4.7	±0.05	2.6	279	154	5.060	324	112	6.377	96	144	8.025	58	154
5.1	±0.05	2.5	263	145	5.494	307	109	7.057	88	142	9.075	52	151
5.6	±0.05	2.4	244	134	6.035	285	105	7.906	78	138	10.39	44	147
6.2	±0.1	2.3	228	126	6.865	267	102	9.517	72	133	13.66	40	141
6.8	±0.1	2.2	213	117	7.694	250	100	11.13	66	128	16.93	35	135
7.5	±0.1	2.1	195	107	8.367	227	98	12.63	57	125	20.91	28	132
8.2	±0.1	2.0	176	97	9.041	205	96	14.14	49	123	24.88	21	129
9.1	±0.1	1.9	161	89	10.20	188	96	18.09	42	122	40.00	16	128
10	±1%	1.8	146	80	11.37	171	95	22.05	36	121	70.00	12	127
11	±1%	1.7	129	71	12.66	153	95	26.44	29	120	140.0	6	126
12	±1%	1.6	112	62	13.95	134	94	30.83	22	119	231.3	1	125
13	±1%	1.6	102	56	15.31	122	93	40.37	18	118	n/a	n/a	n/a
14	±1%	1.5	92	51	16.67	111	92	49.91	15	118	n/a	n/a	n/a
15	±1%	1.5	82	45	18.03	99	90	59.44	11	117	n/a	n/a	n/a
16	±1%	1.4	79	43	19.61	96	90	80.00	8	117	n/a	n/a	n/a
17	±1%	1.4	76	42	21.18	92	90	120.0	6	116	n/a	n/a	n/a
18	±1%	1.3	73	40	22.76	89	90	190.0	4	116	n/a	n/a	n/a
19	±1%	1.3	69	38	24.37	84	89	n/a	n/a	n/a	n/a	n/a	n/a
20	±1%	1.2	65	36	25.98	80	89	n/a	n/a	n/a	n/a	n/a	n/a
22	±1%	1.2	57	31	29.21	72	87	n/a	n/a	n/a	n/a	n/a	n/a
24	±1%	1.2	48	26	34.44	62	87	n/a	n/a	n/a	n/a	n/a	n/a
27	±1%	1.1	43	24	41.87	56	86	n/a	n/a	n/a	n/a	n/a	n/a
30	±1%	1.0	37	21	49.29	49	85	n/a	n/a	n/a	n/a	n/a	n/a
33	±1%	1.0	32	18	56.72	43	84	n/a	n/a	n/a	n/a	n/a	n/a
36	±1%	1.0	27	15	64.15	37	83	n/a	n/a	n/a	n/a	n/a	n/a
39	±1%	1.0	21	12	71.57	30	82	n/a	n/a	n/a	n/a	n/a	n/a



The Important Information/Disclaimer is incorporated in the catalog where these specifications came from or available online at [www.avx.com/disclaimer/](http://www.avx.com/disclaimer/) by reference and should be reviewed in full before placing any order.

# Thin-Film RF/Microwave Capacitor Technology

## Accu-P® Series

### 0805 Typical Electrical Tables



Capacitance @ 1MHz and Tolerance		Self Resonance Frequency (GHz) Typ.	Q Standard Value @ 1GHz		Frequency 900MHz			Frequency 1900MHz			Frequency 2400MHz		
C (pF)	Tol.		Typ.	Min.	C(eff) (pF) Typ.	Q Typ.	ESR (mOhm) Typ.	C(eff) (pF) Typ.	Q Typ.	ESR (mOhm) Typ.	C(eff) (pF) Typ.	Q Typ.	ESR (mOhm) Typ.
0.1	±0.02	17.2	880	484	0.125	890	3296	0.125	545	2417	0.126	447	2265
0.15	±0.02	14.1	872	480	0.176	885	2073	0.178	530	1626	0.181	434	1546
0.2	±0.02	12.3	864	475	0.228	880	1492	0.231	516	1227	0.235	420	1178
0.25	±0.02	11.0	857	471	0.279	874	1156	0.284	501	986	0.290	407	955
0.3	±0.02	10.1	849	467	0.331	869	938	0.337	487	825	0.344	394	804
0.35	±0.02	9.4	841	462	0.382	864	787	0.390	472	710	0.399	380	695
0.4	±0.02	8.8	833	458	0.433	859	675	0.443	458	623	0.453	367	613
0.45	±0.02	8.3	825	454	0.485	853	590	0.496	443	555	0.508	353	549
0.5	±0.02	7.9	817	450	0.536	848	523	0.549	429	501	0.562	340	497
0.55	±0.02	7.5	811	446	0.584	843	469	0.600	420	456	0.616	331	454
0.6	±0.02	7.2	805	443	0.631	838	425	0.651	411	419	0.670	322	418
0.65	±0.02	6.9	798	439	0.679	834	387	0.702	402	387	0.724	313	388
0.7	±0.02	6.7	792	436	0.726	829	356	0.753	393	360	0.778	304	362
0.75	±0.02	6.5	786	432	0.774	824	329	0.804	384	337	0.832	295	339
0.8	±0.02	6.3	779	429	0.822	819	306	0.855	375	316	0.886	286	319
0.85	±0.02	6.1	773	425	0.869	814	285	0.906	366	298	0.940	277	301
0.9	±0.02	5.9	767	422	0.917	810	267	0.957	357	282	0.994	268	285
0.95	±0.02	5.8	760	418	0.964	805	251	1.008	348	267	1.049	260	271
1	±0.02	5.6	754	415	1.012	800	231	1.059	339	235	1.103	251	242
1.05	±0.02	5.5	747	411	1.065	794	223	1.120	335	228	1.170	247	235
1.1	±0.02	5.4	740	407	1.119	788	215	1.181	330	221	1.237	244	228
1.15	±0.02	5.3	732	403	1.172	782	208	1.242	326	214	1.304	240	220
1.2	±0.02	5.1	725	399	1.225	776	200	1.304	322	207	1.371	237	213
1.25	±0.02	5.0	718	395	1.279	770	192	1.365	318	200	1.438	233	206
1.3	±0.02	4.9	711	391	1.332	764	184	1.426	313	193	1.505	230	199
1.35	±0.02	4.9	704	387	1.386	758	176	1.487	309	186	1.573	226	192
1.4	±0.02	4.8	696	383	1.439	752	169	1.548	305	179	1.640	223	184
1.45	±0.02	4.7	689	379	1.492	746	161	1.609	300	172	1.707	219	177
1.5	±0.02	4.6	682	375	1.546	740	153	1.670	296	165	1.774	216	170
1.55	±0.02	4.6	675	371	1.600	733	151	1.734	292	163	1.850	212	168
1.6	±0.02	4.5	668	367	1.654	726	148	1.799	287	161	1.927	208	165
1.65	±0.02	4.4	660	363	1.708	719	146	1.864	283	159	2.003	204	163
1.7	±0.02	4.3	653	359	1.762	712	143	1.928	278	157	2.079	200	160
1.75	±0.02	4.3	646	355	1.816	705	141	1.993	274	155	2.156	197	158
1.8	±0.02	4.2	639	351	1.870	698	139	2.058	269	152	2.232	193	155
1.85	±0.02	4.2	632	347	1.924	691	136	2.122	265	150	2.308	189	153
1.9	±0.02	4.1	624	343	1.978	684	134	2.187	260	148	2.385	185	150
1.95	±0.02	4.1	617	339	2.033	677	131	2.252	256	146	2.461	181	148
2	±0.03	4.0	610	336	2.087	670	129	2.316	251	144	2.537	177	145
2.1	±0.03	3.9	597	328	2.183	658	127	2.440	245	142	2.690	171	143
2.2	±0.03	3.8	584	321	2.280	646	124	2.563	239	139	2.843	165	141
2.3	±0.03	3.8	571	314	2.377	634	122	2.687	233	137	2.996	159	139
2.4	±0.03	3.6	557	307	2.474	623	119	2.810	227	135	3.149	154	136
2.5	±0.03	3.6	544	299	2.571	611	117	2.934	221	133	3.301	148	134
2.6	±0.03	3.6	531	292	2.668	599	114	3.057	215	130	3.454	142	132
2.7	±0.03	3.4	518	285	2.764	587	112	3.181	209	128	3.607	136	130
2.8	±0.03	3.4	507	279	2.875	575	111	3.348	204	127	3.850	132	129
2.9	±0.03	3.4	497	273	2.987	564	110	3.514	199	125	4.093	129	127
3	±0.03	3.3	486	267	3.098	552	109	3.681	194	124	4.335	125	126
3.1	±0.05	3.3	475	261	3.209	540	108	3.848	189	123	4.578	121	125
3.2	±0.05	3.2	465	256	3.320	528	107	4.014	183	122	4.821	118	123
3.3	±0.05	3.1	454	250	3.431	517	106	4.181	178	120	5.064	114	122
3.4	±0.05	3.1	443	244	3.542	505	105	4.348	173	119	5.307	110	121
3.5	±0.05	3.1	433	238	3.653	493	104	4.515	168	118	5.549	107	119
3.6	±0.05	3.0	422	232	3.764	481	103	4.681	163	116	5.792	103	118
3.7	±0.05	3.0	412	226	3.875	470	102	4.848	158	115	6.035	99	116
3.8	±0.05	3.0	401	220	3.986	458	101	5.015	153	114	6.278	96	115
3.9	±0.05	2.9	390	215	4.097	446	100	5.182	148	113	6.521	92	114
4	±0.05	2.9	384	211	4.214	440	99	5.378	144	112	6.861	89	113
4.1	±0.05	2.9	378	208	4.331	434	98	5.574	141	112	7.201	86	113
4.2	±0.05	2.8	372	205	4.448	428	98	5.769	138	111	7.541	84	112



# Thin-Film RF/Microwave Capacitor Technology

## Accu-P® Series

### 0805 Typical Electrical Tables



Capacitance @ 1MHz and Tolerance		Self Resonance Frequency (GHz) Typ.	Q Standard Value @ 1GHz		Frequency 900MHz			Frequency 1900MHz			Frequency 2400MHz		
C (pF)	Tol.		Typ.	Min.	C(eff) (pF) Typ.	Q Typ.	ESR (mOhm) Typ.	C(eff) (pF) Typ.	Q Typ.	ESR (mOhm) Typ.	C(eff) (pF) Typ.	Q Typ.	ESR (mOhm) Typ.
4.3	±0.05	2.7	366	202	4.564	422	97	5.965	134	111	7.881	81	111
4.4	±0.05	2.7	360	198	4.681	415	96	6.161	131	110	8.222	78	111
4.5	±0.05	2.7	355	195	4.798	409	96	6.357	128	110	8.562	75	110
4.6	±0.05	2.7	349	192	4.915	403	95	6.553	124	109	8.902	72	110
4.7	±0.05	2.6	343	188	5.032	397	94	6.749	121	109	9.242	69	109
5.1	±0.05	2.5	319	175	5.499	373	91	7.533	108	107	10.60	58	107
5.6	±0.05	2.4	289	159	6.083	342	88	8.513	91	104	12.30	44	104
6.2	±0.1	2.3	264	145	6.842	313	86	10.43	79	102	18.03	36	103
6.8	±0.1	2.2	239	131	7.601	283	84	12.35	68	101	23.76	28	102
7.5	±0.1	2.1	218	120	8.468	259	83	14.84	61	100	37.25	21	101
8.2	±0.1	2.0	198	109	9.334	234	82	17.32	55	100	50.74	15	100
9.1	±0.1	1.9	179	99	10.57	213	82	24.90	46	100	n/a	n/a	n/a
10	±1%	1.8	160	88	11.80	191	81	32.48	37	100	n/a	n/a	n/a
11	±1%	1.7	139	77	13.17	167	81	40.90	26	101	n/a	n/a	n/a
12	±1%	1.6	119	65	14.54	143	80	49.32	16	101	n/a	n/a	n/a
13	±1%	1.6	110	60	16.17	134	80	n/a	n/a	n/a	n/a	n/a	n/a
14	±1%	1.5	101	55	17.79	125	80	n/a	n/a	n/a	n/a	n/a	n/a
15	±1%	1.5	92	51	19.42	116	80	n/a	n/a	n/a	n/a	n/a	n/a
16	±1%	1.4	87	48	21.13	110	79	n/a	n/a	n/a	n/a	n/a	n/a
17	±1%	1.4	83	46	22.85	104	78	n/a	n/a	n/a	n/a	n/a	n/a
18	±1%	1.3	78	43	24.57	99	77	n/a	n/a	n/a	n/a	n/a	n/a
19	±1%	1.3	73	40	26.41	92	77	n/a	n/a	n/a	n/a	n/a	n/a
20	±1%	1.3	67	37	28.26	85	76	n/a	n/a	n/a	n/a	n/a	n/a
22	±1%	1.2	57	31	31.95	72	76	n/a	n/a	n/a	n/a	n/a	n/a
24	±1%	1.2	46	25	35.64	59	75	n/a	n/a	n/a	n/a	n/a	n/a
27	±1%	1.1	41	22	44.94	54	74	n/a	n/a	n/a	n/a	n/a	n/a
30	±1%	1.0	36	20	54.24	48	73	n/a	n/a	n/a	n/a	n/a	n/a
33	±1%	1.0	30	17	63.54	42	72	n/a	n/a	n/a	n/a	n/a	n/a
36	±1%	0.9	25	14	72.84	37	71	n/a	n/a	n/a	n/a	n/a	n/a
39	±1%	0.9	20	11	82.14	31	70	n/a	n/a	n/a	n/a	n/a	n/a
43	±1%	0.9	16	9	102.9	27	66	n/a	n/a	n/a	n/a	n/a	n/a
47	±1%	0.8	12	7	123.7	23	63	n/a	n/a	n/a	n/a	n/a	n/a



The Important Information/Disclaimer is incorporated in the catalog where these specifications came from or available online at [www.avx.com/disclaimer/](http://www.avx.com/disclaimer/) by reference and should be reviewed in full before placing any order.

# Thin-Film RF/Microwave Capacitor Technology

## Accu-P® Series

### 1210 Typical Electrical Tables



Capacitance @ 1MHz and Tolerance		Self Resonance Frequency (GHz) Typ.	Q Standard Value @ 1GHz		Frequency 900MHz			Frequency 1900MHz			Frequency 2400MHz		
C (pF)	Tol.		Typ.	Min.	C(eff) (pF) Typ.	Q Typ.	ESR (mOhm) Typ.	C(eff) (pF) Typ.	Q Typ.	ESR (mOhm) Typ.	C(eff) (pF) Typ.	Q Typ.	ESR (mOhm) Typ.
0.1	±0.02	15.6	1190	654	0.136	1176	3633	0.136	606	2149	0.136	450	2068
0.15	±0.03	12.7	1179	648	0.190	1166	2129	0.190	597	1407	0.191	444	1370
0.2	±0.02	11.0	1168	642	0.244	1156	1457	0.244	589	1042	0.246	438	1023
0.25	±0.02	9.8	1156	636	0.297	1145	1086	0.299	581	826	0.301	432	816
0.3	±0.02	8.9	1145	630	0.351	1135	854	0.353	573	683	0.356	426	678
0.35	±0.02	8.3	1134	624	0.405	1125	697	0.408	565	581	0.411	421	580
0.4	±0.02	7.7	1123	618	0.459	1115	584	0.462	557	505	0.466	415	506
0.45	±0.02	7.3	1112	612	0.513	1105	500	0.516	549	447	0.521	409	449
0.5	±0.02	6.9	1101	606	0.567	1095	435	0.571	541	400	0.576	403	404
0.55	±0.02	6.6	1090	599	0.617	1084	384	0.621	532	362	0.627	397	366
0.6	±0.02	6.3	1079	593	0.666	1074	342	0.672	524	331	0.679	391	335
0.65	±0.02	6.0	1068	587	0.716	1064	308	0.723	516	304	0.731	385	309
0.7	±0.02	5.8	1057	581	0.765	1054	279	0.774	508	282	0.783	379	287
0.75	±0.02	5.6	1046	575	0.815	1044	255	0.824	500	262	0.834	374	267
0.8	±0.02	5.4	1035	569	0.864	1034	234	0.875	492	245	0.886	368	250
0.85	±0.02	5.3	1023	563	0.914	1024	216	0.926	484	230	0.938	362	236
0.9	±0.02	5.1	1012	557	0.963	1013	201	0.976	476	217	0.989	356	222
0.95	±0.02	5.0	1001	551	1.013	1003	187	1.027	467	205	1.041	350	210
1	±0.02	5.0	992	546	1.062	983	167	1.078	459	170	1.093	344	177
1.05	±0.02	4.9	981	539	1.107	975	163	1.124	451	167	1.141	338	174
1.1	±0.02	4.8	969	533	1.152	966	158	1.170	443	165	1.189	331	172
1.15	±0.02	4.7	958	527	1.196	958	154	1.217	435	162	1.236	325	169
1.2	±0.02	4.6	946	521	1.241	950	150	1.263	427	160	1.284	318	167
1.25	±0.02	4.5	935	514	1.285	942	146	1.309	419	157	1.332	312	164
1.3	±0.02	4.4	923	508	1.330	933	142	1.355	410	155	1.380	305	162
1.35	±0.02	4.3	912	502	1.375	925	138	1.402	402	152	1.428	299	159
1.4	±0.02	4.2	900	495	1.419	917	134	1.448	394	150	1.476	293	156
1.45	±0.02	4.1	889	489	1.464	908	129	1.494	386	147	1.524	286	154
1.5	±0.02	4.1	877	483	1.508	900	125	1.541	378	144	1.572	280	151
1.55	±0.02	4.0	862	474	1.567	890	123	1.618	371	143	1.638	274	150
1.6	±0.02	3.9	846	465	1.626	881	122	1.694	363	142	1.704	268	149
1.65	±0.02	3.9	831	457	1.685	871	120	1.771	356	140	1.770	262	148
1.7	±0.02	3.8	815	448	1.743	862	118	1.848	349	139	1.836	256	147
1.75	±0.02	3.7	800	440	1.802	852	116	1.925	342	138	1.902	250	145
1.8	±0.02	3.7	784	431	1.861	843	114	2.002	334	136	1.968	244	144
1.85	±0.02	3.6	769	423	1.920	833	112	2.079	327	135	2.034	239	143
1.9	±0.02	3.5	753	414	1.978	824	110	2.156	320	134	2.100	233	142
1.95	±0.02	3.4	737	406	2.037	814	108	2.233	313	132	2.167	227	141
2	±0.03	3.3	722	397	2.096	805	107	2.310	305	131	2.233	221	139
2.1	±0.03	3.2	691	380	2.213	786	103	2.464	291	128	2.365	209	137
2.2	±0.03	3.0	660	363	2.331	767	99	2.618	276	126	2.497	198	135
2.3	±0.03	2.9	644	354	2.420	747	97	2.681	268	123	2.613	191	132
2.4	±0.03	2.9	629	346	2.508	728	96	2.744	259	121	2.729	185	130
2.5	±0.03	2.8	614	338	2.597	709	94	2.807	251	118	2.845	179	128
2.6	±0.03	2.8	598	329	2.686	689	93	2.870	242	116	2.961	173	126
2.7	±0.03	2.7	583	321	2.775	670	91	2.933	234	114	3.077	167	123
2.8	±0.03	2.7	574	316	2.875	659	90	3.047	230	113	3.205	164	122
2.9	±0.03	2.7	566	311	2.975	647	89	3.162	227	112	3.334	161	121
3	±0.03	2.7	557	306	3.075	636	88	3.276	223	111	3.462	157	121
3.1	±0.05	2.7	548	302	3.174	625	87	3.390	220	110	3.590	154	120
3.2	±0.05	2.6	540	297	3.274	613	87	3.504	216	109	3.718	151	119
3.3	±0.05	2.6	531	292	3.374	602	86	3.619	213	108	3.847	148	118
3.4	±0.05	2.6	522	287	3.474	591	85	3.733	209	107	3.975	145	117
3.5	±0.05	2.6	514	283	3.574	579	84	3.847	206	106	4.103	141	116
3.6	±0.05	2.5	505	278	3.674	568	83	3.961	202	105	4.231	138	115
3.7	±0.05	2.5	496	273	3.773	556	82	4.076	198	104	4.359	135	114
3.8	±0.05	2.5	488	268	3.873	545	81	4.190	195	103	4.488	132	113



# Thin-Film RF/Microwave Capacitor Technology

## Accu-P® Series

### 1210 Typical Electrical Tables



Capacitance @ 1MHz and Tolerance		Self Resonance Frequency (GHz) Typ.	Q Standard Value @ 1GHz		Frequency 900MHz			Frequency 1900MHz			Frequency 2400MHz		
C (pF)	Tol.		Typ.	Min.	C(eff) (pF) Typ.	Q Typ.	ESR (mOhm) Typ.	C(eff) (pF) Typ.	Q Typ.	ESR (mOhm) Typ.	C(eff) (pF) Typ.	Q Typ.	ESR (mOhm) Typ.
3.9	±0.05	2.4	479	264	3.973	534	80	4.304	191	102	4.616	129	112
4	±0.05	2.4	473	260	4.083	528	79	4.435	189	101	4.768	127	112
4.1	±0.05	2.4	467	257	4.192	522	78	4.565	186	100	4.919	125	111
4.2	±0.05	2.4	462	254	4.302	516	78	4.695	183	100	5.071	123	110
4.3	±0.05	2.3	456	251	4.411	511	77	4.825	180	99	5.223	121	110
4.4	±0.05	2.3	450	247	4.521	505	76	4.956	178	98	5.375	119	109
4.5	±0.05	2.3	444	244	4.630	499	75	5.086	175	98	5.526	117	108
4.6	±0.05	2.3	438	241	4.740	493	75	5.216	172	97	5.678	115	108
4.7	±0.05	2.2	432	238	4.849	487	74	5.347	170	96	5.830	113	107
5.1	±0.05	2.1	408	225	5.288	464	71	5.868	159	93	6.437	106	105
5.6	±0.05	2.0	379	208	5.835	435	67	6.519	145	90	7.195	96	102
6.2	±0.1	1.9	355	195	6.440	408	65	7.176	137	86	7.897	91	96
6.8	±0.1	1.8	330	182	7.044	380	62	7.832	129	83	8.599	85	91
7.5	±0.1	1.7	308	169	7.823	351	61	8.927	115	81	10.08	74	89
8.2	±0.1	1.7	285	157	8.601	322	60	10.02	100	78	11.55	63	87
9.1	±0.1	1.6	266	146	9.600	304	58	11.55	93	77	13.93	57	85
10	±1%	1.5	247	136	10.60	285	57	13.09	85	76	16.30	50	84
11	±1%	1.5	225	124	11.71	265	56	14.79	76	74	18.94	43	82
12	±1%	1.4	204	112	12.82	244	54	16.49	68	73	21.57	36	81
13	±1%	1.3	193	106	13.97	230	53	18.64	61	72	26.09	32	80
14	±1%	1.3	181	99	15.13	215	53	20.80	55	71	30.61	28	79
15	±1%	1.2	169	93	16.28	200	52	22.95	48	70	35.13	24	78
16	±1%	1.2	164	90	17.51	195	51	26.01	46	69	46.51	22	76
17	±1%	1.2	159	88	18.75	189	50	29.07	43	67	57.90	19	75
18	±1%	1.1	154	85	19.98	183	49	32.14	41	66	69.29	17	73
19	±1%	1.1	150	82	21.21	178	49	36.34	39	66	n/a	n/a	n/a
20	±1%	1.1	145	80	22.43	172	49	40.55	38	65	n/a	n/a	n/a
22	±1%	1.0	136	75	24.88	162	49	48.96	34	64	n/a	n/a	n/a
24	±1%	1.0	126	70	27.34	151	48	57.38	31	63	n/a	n/a	n/a
27	±1%	0.9	112	62	31.02	135	48	70.00	26	62	n/a	n/a	n/a
30	±1%	0.9	101	56	36.14	121	48	n/a	n/a	n/a	n/a	n/a	n/a
33	±1%	0.8	90	50	41.27	108	48	n/a	n/a	n/a	n/a	n/a	n/a
36	±1%	0.8	79	44	46.39	95	48	n/a	n/a	n/a	n/a	n/a	n/a
39	±1%	0.8	68	38	51.52	82	48	n/a	n/a	n/a	n/a	n/a	n/a
43	±1%	0.7	54	30	58.35	64	48	n/a	n/a	n/a	n/a	n/a	n/a
47	±1%	0.7	39	21	65.18	46	48	n/a	n/a	n/a	n/a	n/a	n/a
82	±1%	0.7	17	10	148.400	24	48	n/a	n/a	n/a	n/a	n/a	n/a



The Important Information/Disclaimer is incorporated in the catalog where these specifications came from or available online at [www.avx.com/disclaimer/](http://www.avx.com/disclaimer/) by reference and should be reviewed in full before placing any order.

**Accu-P® 01005 Typical SRF vs Capacitance**

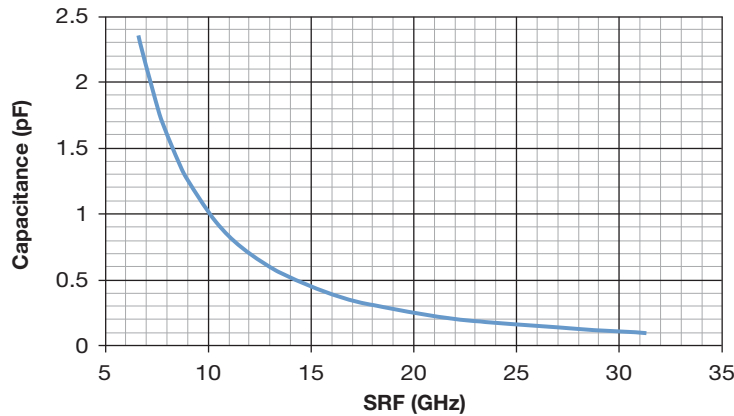

Measured on HP8720ES

**Accu-P® 01005 Typical ESR vs Frequency**

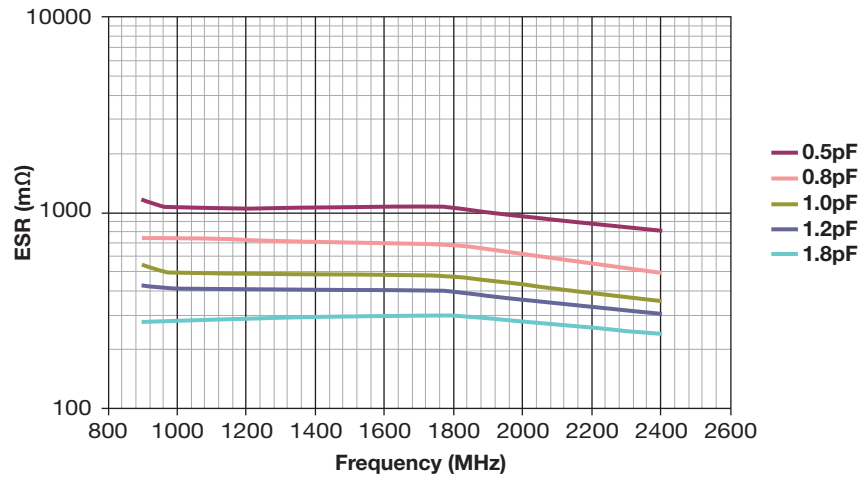

Measured on Agilent 4278A/4991A

**Accu-P® 01005 Typical Q vs Frequency**

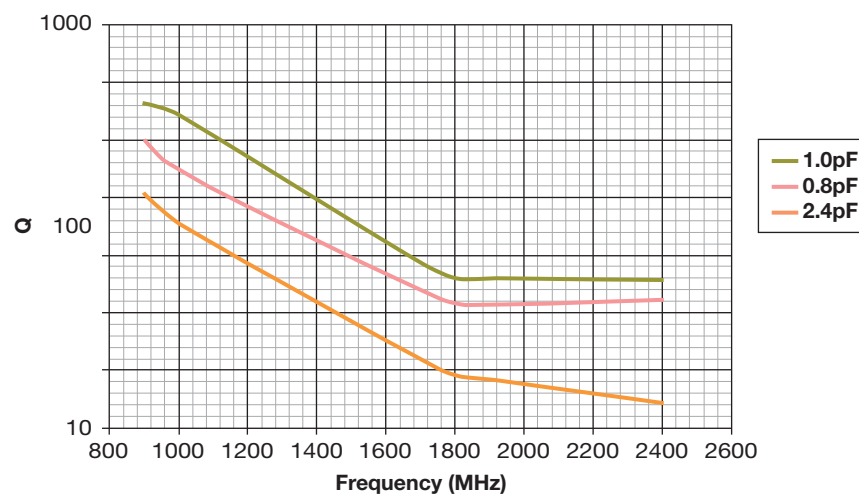

Measured on Agilent 4278A/4991A

# Thin-Film RF/Microwave Capacitor Technology

## Accu-P® Series

### High Frequency Characteristics

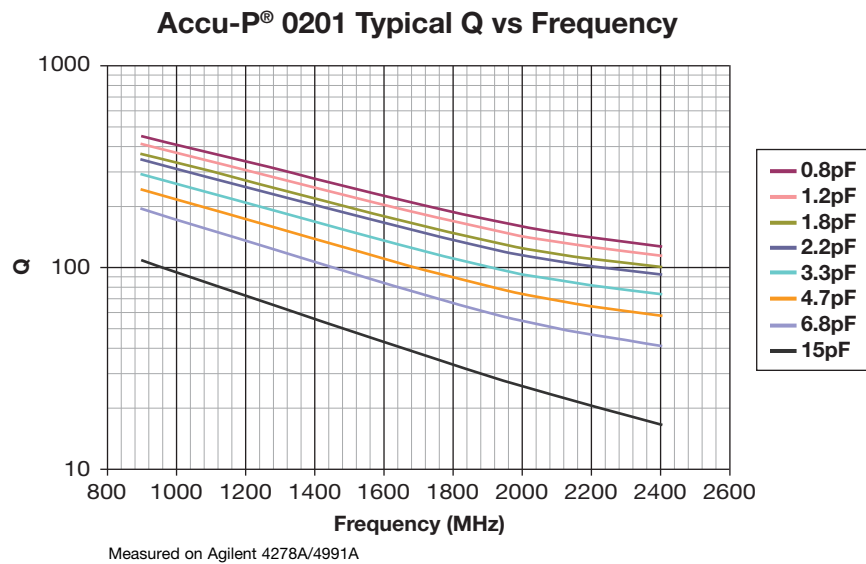
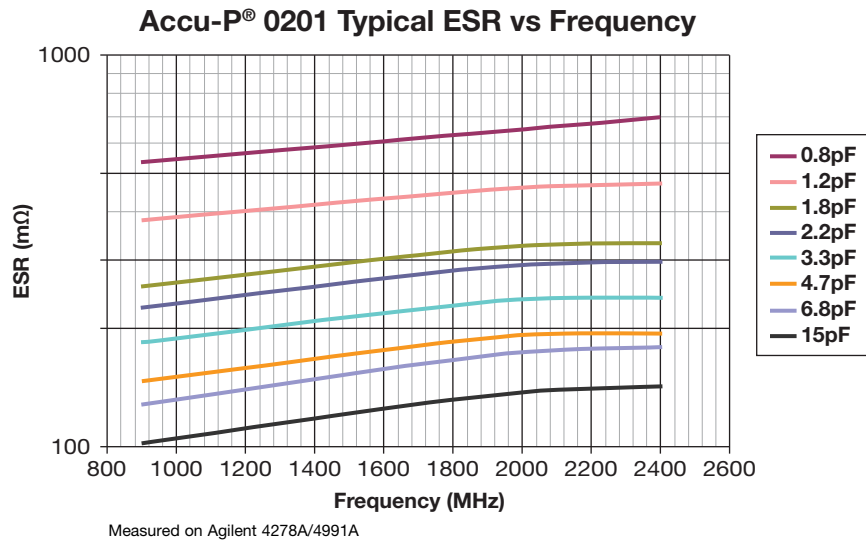
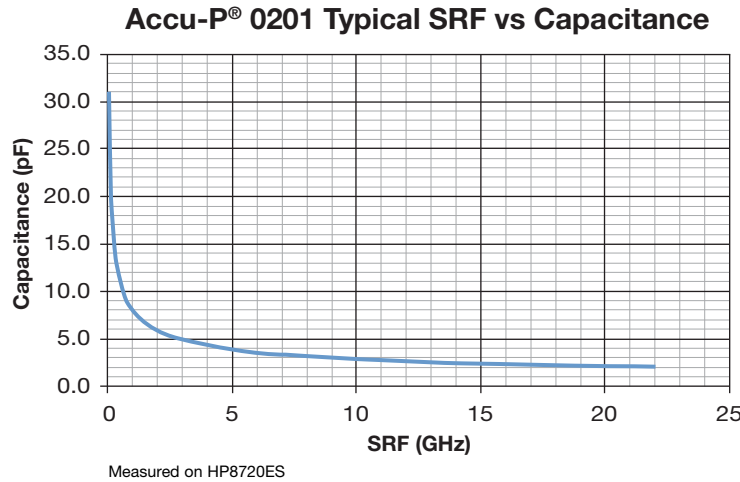

The Important Information/Disclaimer is incorporated in the catalog where these specifications came from or available online at [www.avx.com/disclaimer/](http://www.avx.com/disclaimer/) by reference and should be reviewed in full before placing any order.



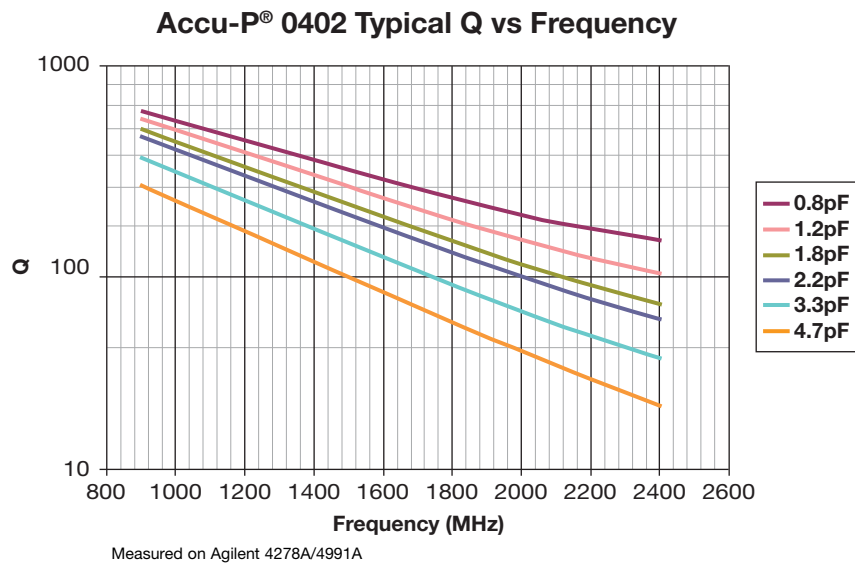
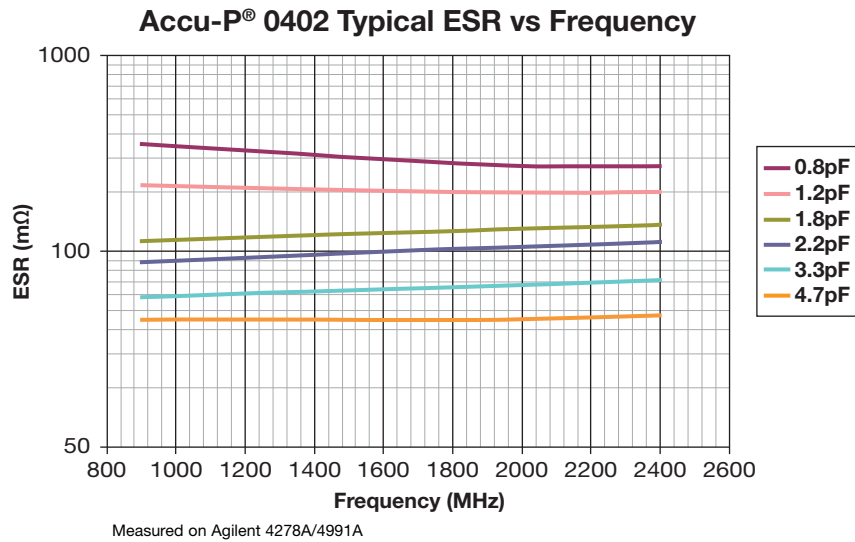
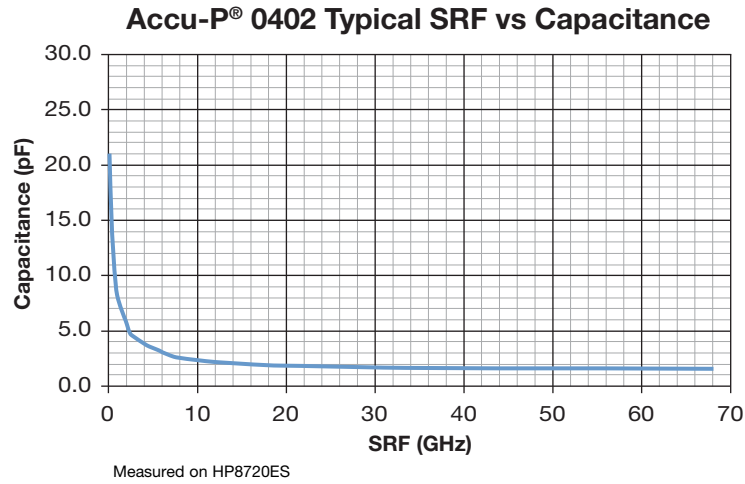

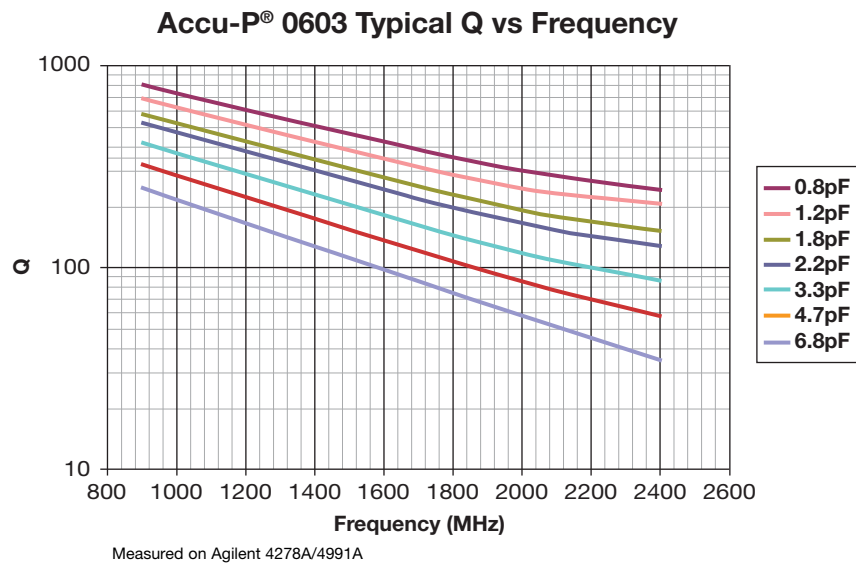
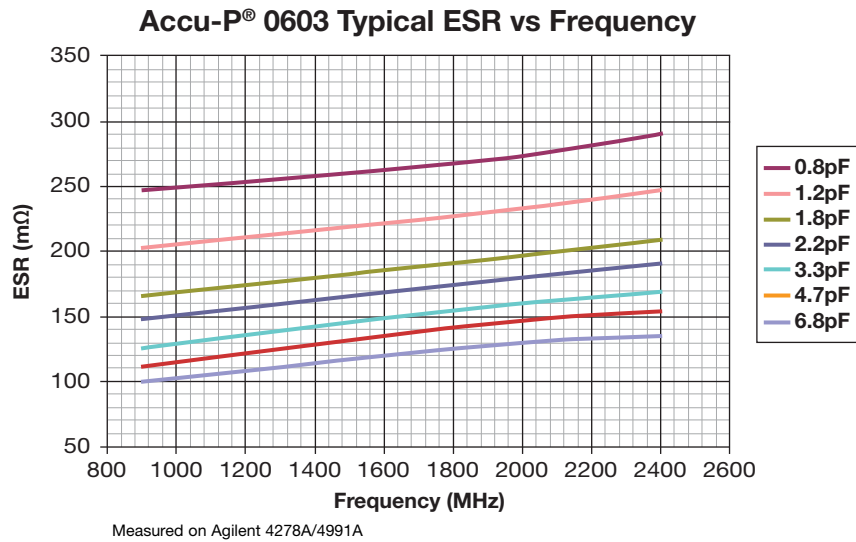
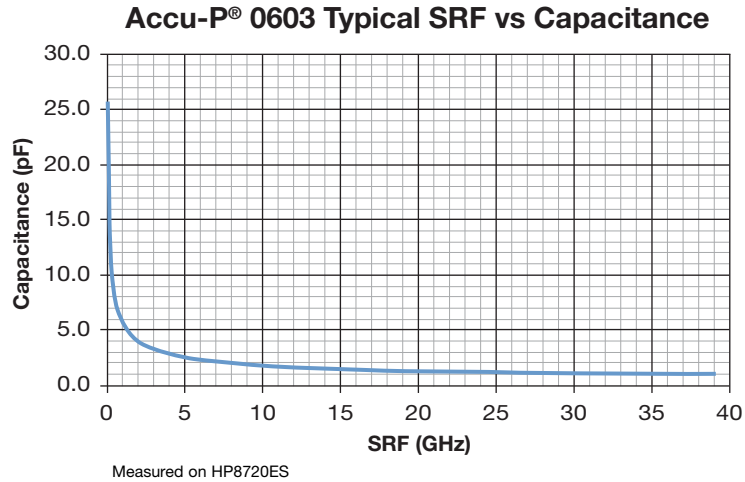

#### Accu-P® 0805 Typical SRF vs Capacitance

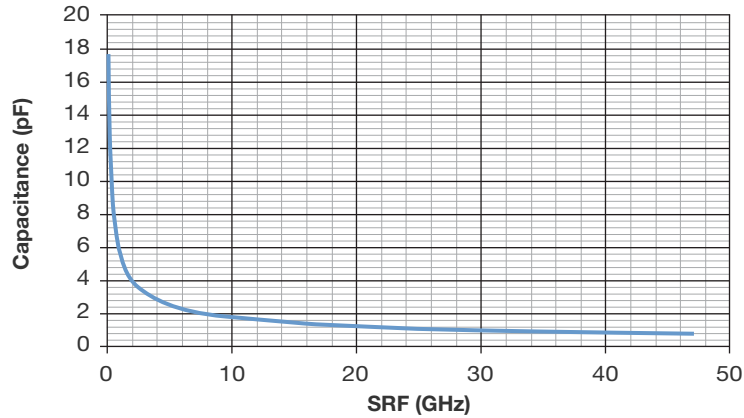

Measured on HP8720ES

#### Accu-P® 0805 Typical ESR vs Frequency

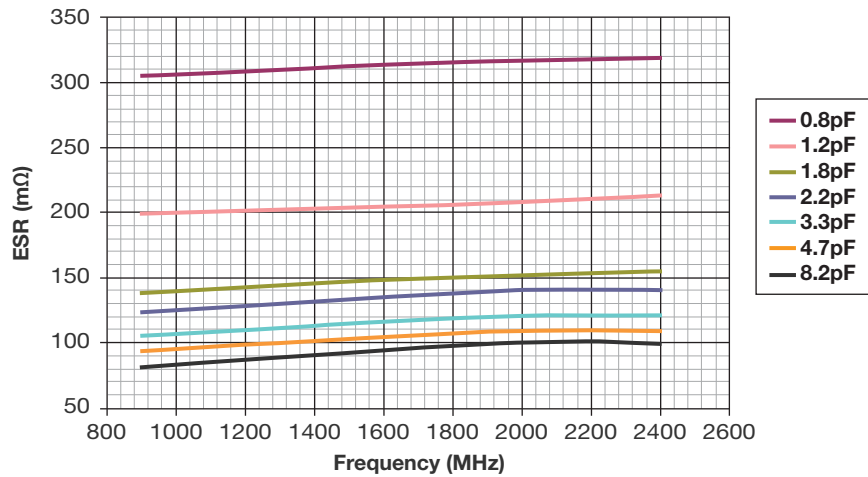

Measured on Agilent 4278A/4991A

#### Accu-P® 0805 Typical Q vs Frequency

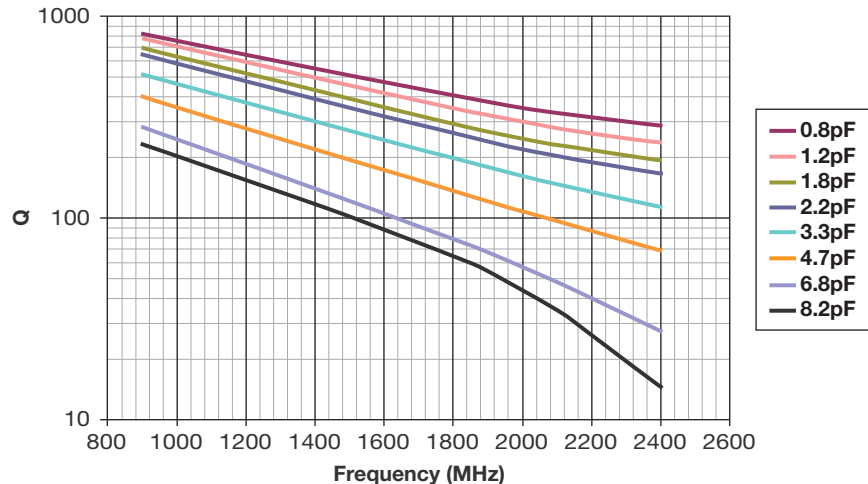

Measured on Agilent 4278A/4991A

# Thin-Film RF/Microwave Capacitor Technology

## Accu-P® Series

### High Frequency Characteristics

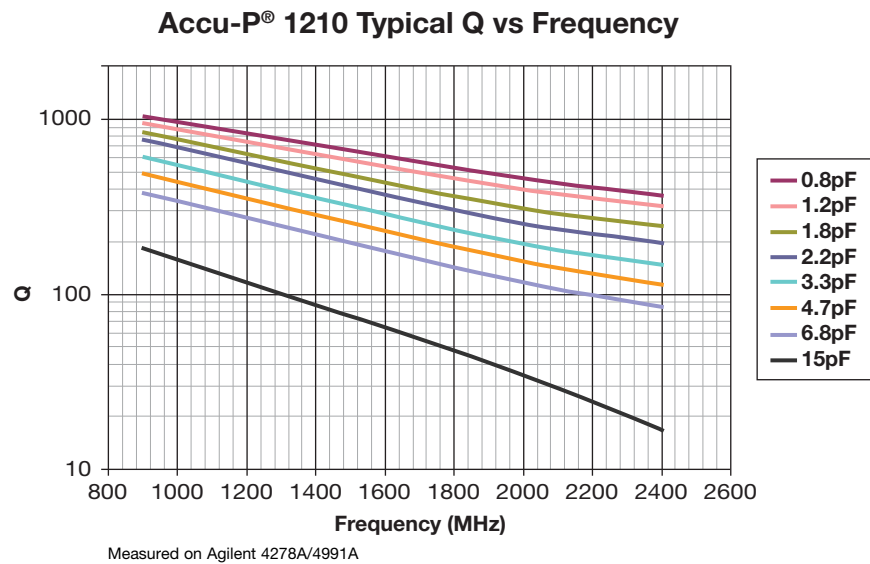
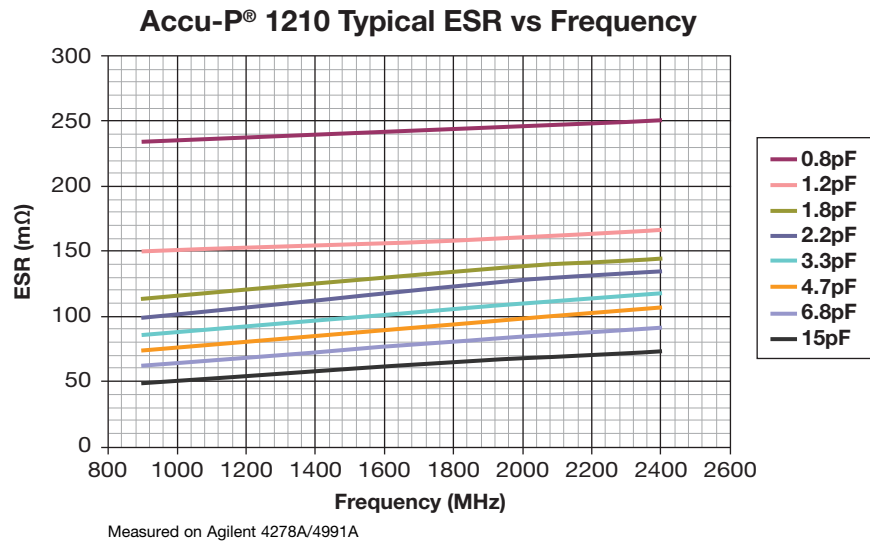
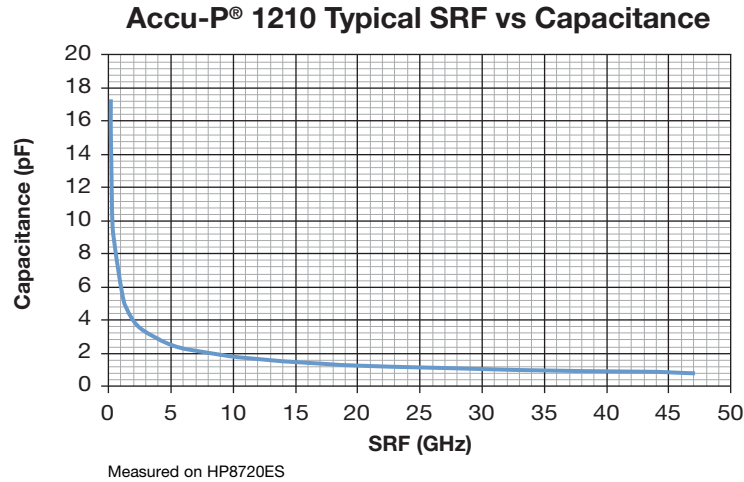

The Important Information/Disclaimer is incorporated in the catalog where these specifications came from or available online at [www.avx.com/disclaimer/](http://www.avx.com/disclaimer/) by reference and should be reviewed in full before placing any order.

# Thin-Film RF/Microwave Capacitor Technology

## Accu-P® Series

### Environmental / Mechanical Characteristics



#### ENVIRONMENTAL CHARACTERISTICS

TEST	CONDITIONS	REQUIREMENT
Life (Endurance) MIL-STD-202F Method 108A	125°C, 2UR, 1000 hours	No visible damage $\Delta C/C \leq 2\%$ for $C \geq 5pF$ $\Delta C \leq 0.25pF$ for $C < 5pF$
Accelerated Damp Heat Steady State MIL-STD-202F Method 103B	85°C, 85% RH, UR, 1000 hours	No visible damage $\Delta C/C \leq 2\%$ for $C \geq 5pF$ $\Delta C \leq 0.25pF$ for $C < 5pF$
Temperature Cycling MIL-STD-202F Method 107E MIL-STD-883D Method 1010.7	-55°C to +125°C, 15 cycles – Accu-P®	No visible damage $\Delta C/C \leq 2\%$ for $C \geq 5pF$ $\Delta C \leq 0.25pF$ for $C < 5pF$
Resistance to Solder Heat IEC-68-2-58	260°C ± 5°C for 10 secs	C remains within initial limits

#### MECHANICAL CHARACTERISTICS

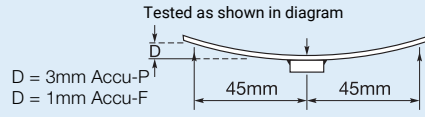
TEST	CONDITIONS	REQUIREMENT
Solderability IEC-68-2-58	Components completely immersed in a solder bath at 235°C for 2 secs.	Terminations to be well tinned, minimum 95% coverage
Leach Resistance IEC-68-2-58	Components completely immersed in a solder bath at 260±5°C for 60 secs.	Dissolution of termination faces ≤15% of area Dissolution of termination edges ≤25% of length
Adhesion MIL-STD-202F Method 211A	A force of 5N applied for 10 secs.	No visible damage
Termination Bond Strength IEC-68-2-21 Amend. 2	Tested as shown in diagram  D = 3mm Accu-P D = 1mm Accu-F	No visible damage $\Delta C/C \leq 2\%$ for $C \geq 5pF$ $\Delta C \leq 0.25pF$ for $C < 5pF$
Robustness of Termination IEC-68-2-21 Amend. 2	A force of 5N applied for 10 secs.	No visible damage
High Frequency Vibration MIL-STD-202F Method 201A, 204D (Accu-P® only)	55Hz to 2000Hz, 20G	No visible damage
Storage	12 months minimum with components stored in "as received" packaging	Good solderability

#### QUALITY & RELIABILITY

Accu-P® is based on well established thin-film technology and materials.

##### • ON-LINE PROCESS CONTROL

This program forms an integral part of the production cycle and acts as a feedback system to regulate and control production processes. The test procedures, which are integrated into the production process, were developed after long research work and are based on the highly developed semiconductor industry test procedures and equipment. These measures help AVX to produce a consistent and high yield line of products.

##### • FINAL QUALITY INSPECTION

Finished parts are tested for standard electrical parameters and visual/mechanical characteristics. Each production lot is 100% evaluated for: capacitance and proof voltage at 2.5 UR. In addition, production is periodically evaluated for:

- Average capacitance with histogram printout for capacitance distribution;
- IR and Breakdown Voltage distribution;
- Temperature Coefficient;
- Solderability;
- Dimensional, mechanical and temperature stability.

#### QUALITY ASSURANCE

The reliability of these thin-film chip capacitors has been studied intensively for several years. Various measures have been taken to obtain the high reliability required today by the industry. Quality assurance policy is based on well established international industry standards. The reliability of the capacitors is determined by accelerated testing under the following conditions:

Life (Endurance)	125°C, 2UR, 1000 hours
Accelerated Damp Heat Steady State	85°C, 85% RH, UR, 1000 hours.

# Thin-Film RF/Microwave Capacitor Technology

## Accu-P® Series

### Performance Characteristics RF Power Applications



#### RF POWER APPLICATIONS

In RF power applications capacitor losses generate heat. Two factors of particular importance to designers are:

- Minimizing the generation of heat.
- Dissipating heat as efficiently as possible.

#### CAPACITOR HEATING

- The major source of heat generation in a capacitor in RF power applications is a function of RF current (I) and ESR, from the relationship:
- Power dissipation =  $I_{RMS}^2 \times ESR$
- Accu-P® capacitors are specially designed to minimize ESR and therefore RF heating. Values of ESR for Accu-P® capacitors are significantly less than those of ceramic MLC components currently available.

#### HEAT DISSIPATION

- Heat is dissipated from a capacitor through a variety of paths, but the key factor in the removal of heat is the thermal conductivity of the capacitor material.
- The higher the thermal conductivity of the capacitor, the more rapidly heat will be dissipated.
- The table below illustrates the importance of thermal conductivity to the performance of Accu-P® in power applications.

Data used in calculating the graph:

Thermal impedance of capacitors:

- 0402 17°C/W
- 0603 12°C/W
- 0805 6.5°C/W
- 1210 5°C/W

PRODUCT	MATERIAL	THERMAL CONDUCTIVITY W/mK
Accu-P® Microwave MLC	Alumina Magnesium Titanate	18.9 6.0

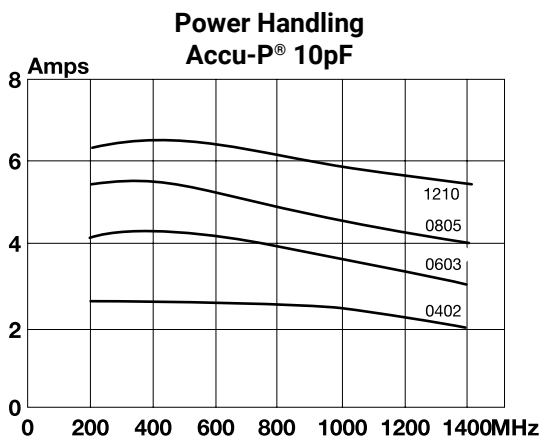

Thermal impedance measured using RF generator, amplifier and strip-line transformer. ESR of capacitors measured on Boonton 34A

#### THERMAL IMPEDANCE

Thermal impedance of Accu-P® chips is shown below compared with the thermal impedance of Microwave MLC's.

The thermal impedance expresses the temperature difference in °C between chip center and termination caused by a power dissipation of 1 watt in the chip. It is expressed in °C/W.

#### ADVANTAGES OF ACCU-P® IN RF POWER CIRCUITS

The optimized design of Accu-P® offers the designer of RF power circuits the following advantages:

- Reduced power losses due to the inherently low ESR of Accu-P®.
- Increased power dissipation due to the high thermal conductivity of Accu-P®.
- The only true test of a capacitor in any particular application is its performance under operating conditions in the actual circuit.

CAPACITOR TYPE	CHIP SIZE	THERMAL IMPEDANCE (°C/W)
Accu-P®	0805	6.5
	1210	5
Microwave MLC	0505	12
	1210	7.5

#### PRACTICAL APPLICATION IN RF POWER CIRCUITS

- There is a wide variety of different experimental methods for measuring the power handling performance of a capacitor in RF power circuits. Each method has its own problems and few of them exactly reproduce the conditions present in "real" circuit applications.
- Similarly, there is a very wide range of different circuit applications, all with their unique characteristics and operating conditions which cannot possibly be covered by such "theoretical" testing.



The Important Information/Disclaimer is incorporated in the catalog where these specifications came from or available online at [www.avx.com/disclaimer/](http://www.avx.com/disclaimer/) by reference and should be reviewed in full before placing any order.

#### GENERAL

Accu-P® SMD capacitors are designed for soldering to printed circuit boards or other substrates. The construction of the components is such that they will withstand the time/temperature profiles used in both wave and reflow soldering methods.

#### CIRCUIT BOARD TYPE

The circuit board types which may be used with Accu-P® are as follows:

All flexible types of circuit boards  
(eg. FR-4, G-10) and also alumina.

For other circuit board materials, please consult factory.

#### HANDLING

SMD capacitors should be handled with care to avoid damage or contamination from perspiration and skin oils. The use of plastic tipped tweezers or vacuum pick-ups is strongly recommended for individual components. Bulk handling should ensure that abrasion and mechanical shock are minimized. For automatic equipment, taped and reeled product gives the ideal medium for direct presentation to the placement machine.

#### COMPONENT PAD DESIGN

Component pads must be designed to achieve good joints and minimize component movement during reflow soldering. Pad designs are given below for both wave and reflow soldering.

The basis of these designs is:

- Pad width equal to component width. It is permissible to decrease this to as low as 85% of component width but it is not advisable to go below this.
- Pad overlap 0.5mm beneath large components. Pad overlap about 0.3mm beneath small components.
- Pad extension of 0.5mm for reflow of large components and pad extension about 0.3mm for reflow of small components. Pad extension about 1.0mm for wave soldering.

#### REFLOW SOLDERING PAD DIMENSIONS: millimeters (inches)

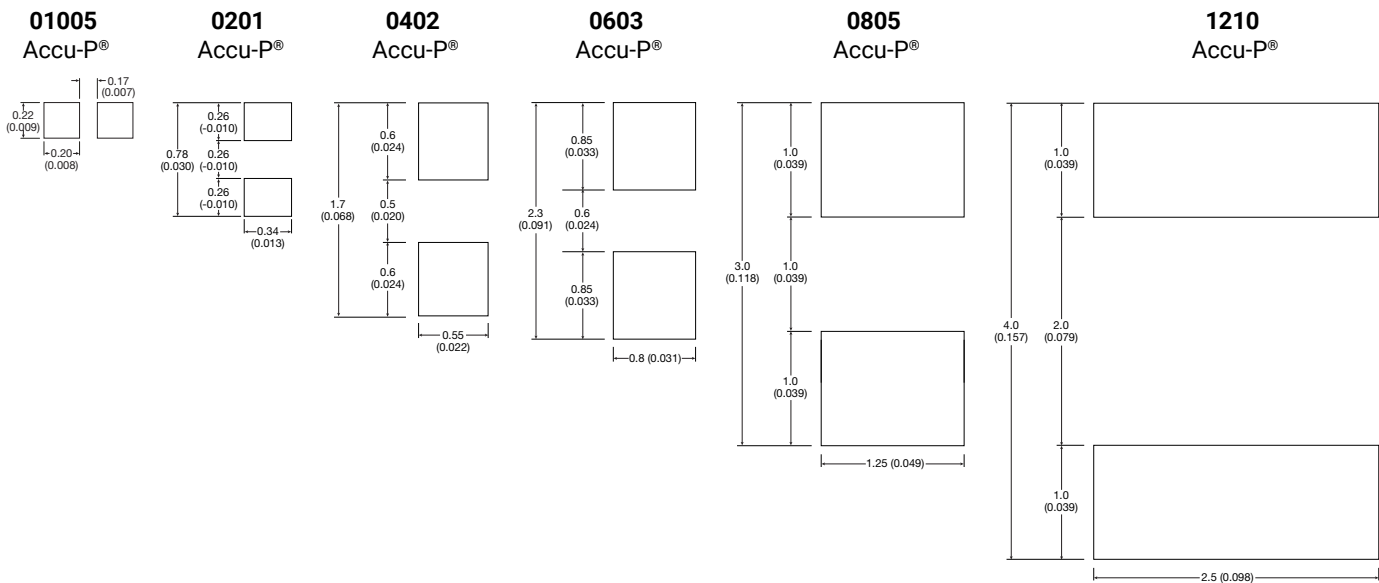

# Thin-Film RF/Microwave Capacitor Technology

## Accu-P® Series

### Application Notes



#### PREHEAT & SOLDERING

The rate of preheat in production should not exceed 4°C/ second and a recommended maximum is about 2°C/second. Temperature differential from preheat to soldering should not exceed 100°C.

For further specific application or process advice, please consult AVX.

#### COOLING

After soldering, the assembly should preferably be allowed to cool naturally. In the event of assisted cooling, similar conditions to those recommended for preheating should be used.

#### HAND SOLDERING & REWORK

Hand soldering is permissible. Preheat of the PCB to 150°C is required. The most preferable technique is to use hot air soldering tools. Where a soldering iron is used, a temperature controlled model not exceeding 30 watts should be used and set to not more than 260°C.

#### CLEANING RECOMMENDATIONS

Care should be taken to ensure that the devices are thoroughly cleaned of flux residues, especially the space beneath the device. Such residues may otherwise become conductive and effectively offer a lossy bypass to the device. Various recommended cleaning conditions (which must be optimized for the flux system being used) are as follows:

- Cleaning liquids.....i-propanol, ethanol, acetylacetone, water and other standard PCB cleaning liquids.
- Ultrasonic conditions .....power-20w/liter max.  
frequency-20kHz to 45kHz.
- Temperature .....80°C maximum (if not otherwise limited by chosen solvent system).
- Time .....5 minutes max.

#### STORAGE CONDITIONS

Recommended storage conditions for Accu-P® prior to use are as follows:

- Temperature .....15°C to 35°C
- Humidity ..... ≤65%
- Air Pressure .....860mbar to 1060mbar

#### RECOMMENDED REFLOW SOLDERING PROFILE COMPONENTS WITH SNPB TERMINATIONS

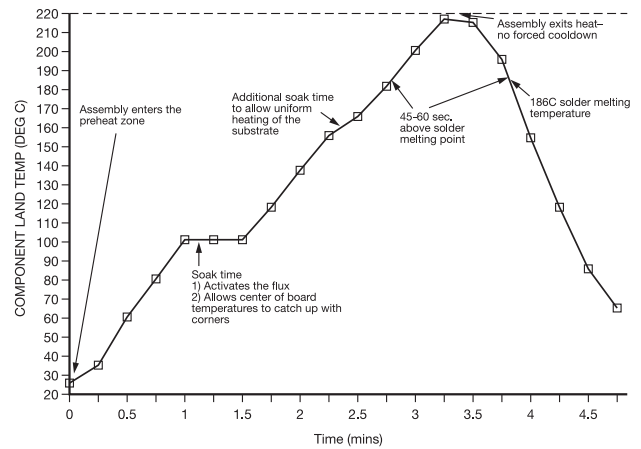

#### RECOMMENDED REFLOW SOLDERING PROFILE LEAD FREE COMPONENTS WITH SN100 TERMINATIONS

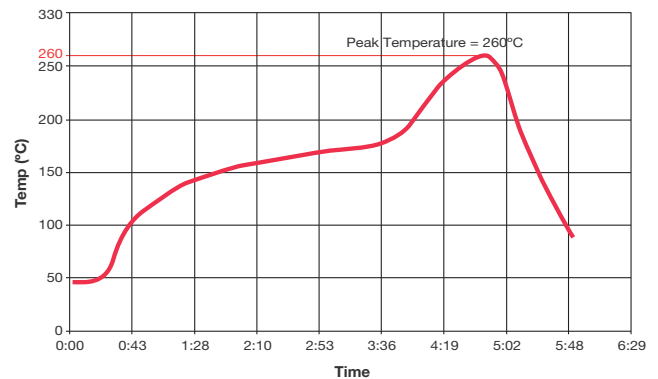

The Important Information/Disclaimer is incorporated in the catalog where these specifications came from or available online at [www.avx.com/disclaimer/](http://www.avx.com/disclaimer/) by reference and should be reviewed in full before placing any order.



# Thin-Film RF/Microwave Capacitor Technology

## Accu-P® Series

### Automatic Insertion Packaging



#### TAPE & REEL

All tape and reel specifications are in compliance with EIA 481-1-A. (equivalent to IEC 286 part 3).

- 8mm carrier
- Reeled quantities: Reels of 3,000 per 7" reel or 10,000 pieces per 13" reel  
01005, 0201, and 0402 = 5,000 pieces per 7" reel and 20,000 pieces per 13" reel

#### REEL DIMENSIONS: millimeters (inches)

A(1)	B	C	D	E	F	G
180±1.0 (7.087±0.039)	1.5 min. (0.059 min.)	13±0.2 (0.512 ± 0.008)	20.2 min. (0.795 min.)	50 min. (1.969 min.)	9.6±1.5 (0.370 ± 0.050)	14.4 max. (0.567 max.)

Metric dimensions will govern.

Inch measurements rounded and for reference only.

(1) 330mm (13 inch) reels are available.

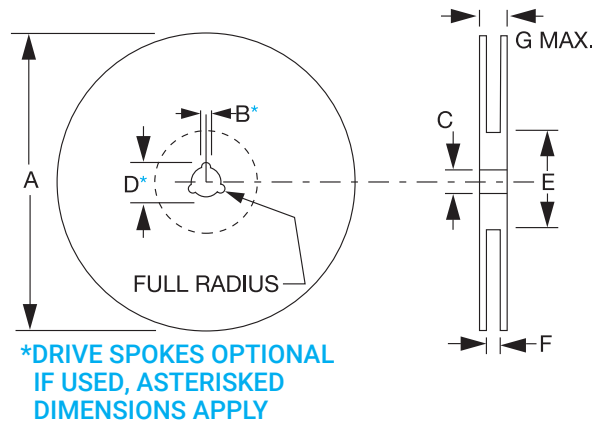

#### CARRIER DIMENSIONS: millimeters (inches)

A	B	C	D	E	F
8.0 ± 0.3 (0.315 ± 0.012)	3.5 ± 0.05 (0.138 ± 0.002)	1.75 ± 0.1 (0.069 ± 0.004)	2.0 ± 0.05 (0.079 ± 0.002)	4.0 ± 0.1 (0.157 ± 0.004)	1.5 <sup>+0.1</sup> <sub>-0.0</sub> (0.059 <sup>+0.004</sup> <sub>-0.000</sub> )

The nominal dimensions of the component compartment (W,L) are derived from the component size.

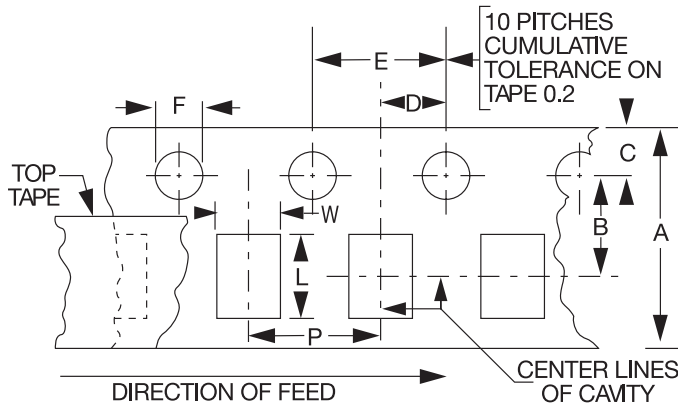

P = 4mm for 0603, 0805, 1210  
P = 2mm for 01005, 0201, and 0402

AVX reserves the right to change the information published herein without notice.