

PLEASE CHECK WWW.MOLEX.COM FOR LATEST PART INFORMATION

Part Number: [52892-1295](#)
Status: **Active**
Description: 0.50mm Pitch Easy-On™ Type FFC/FPC Connector, Right Angle, SMT, ZIF, Bottom Contact Style, Cable Retention Guide, 12 Circuits, Lead-Free

Documents:

[3D Model](#) [Packaging Specification SPK-52892-001 \(PDF\)](#)
[Drawing \(PDF\)](#) [RoHS Certificate of Compliance \(PDF\)](#)
[Product Specification PS-52892-038 \(PDF\)](#)

General

Product Family	FFC/FPC Connectors
Series	52892
Comments	Hinge, Cable Guide
Product Name	Easy-On™
UPC	822348116423

Physical

Circuits (Loaded)	12
Color - Resin	Natural
Contact Position	Bottom
Durability (mating cycles max)	20
Entry Angle	90° Angle
Mated Height	2.00mm
Material - Metal	Phosphor Bronze
Material - Plating Mating	Tin-Bismuth
Material - Plating Termination	Tin-Bismuth
Material - Resin	High Temperature Thermoplastic
Net Weight	154.908/mg
Number of Rows	1
Orientation	Right Angle
PCB Locator	No
PCB Retention	Yes
Packaging Type	Embossed Tape on Reel
Pitch - Mating Interface	0.50mm
Plating min - Mating	1.016µm
Plating min - Termination	1.016µm
Polarized to PCB	No
Stackable	No
Surface Mount Compatible (SMC)	N/A
Temperature Range - Operating	-25°C to +85°C
Termination Interface: Style	Surface Mount
Wire/Cable Type	FFC/FPC

Electrical

Current - Maximum per Contact	0.5A
Voltage - Maximum	50V

Material Info

Reference - Drawing Numbers

Packaging Specification	SPK-52892-001
Product Specification	PS-52892-038, RPS-52892-036, RPS-52892-039, RPS-52892-045, RPS-52892-049, RPS-52892-052
Sales Drawing	SD-52892-040, SD-52892-041

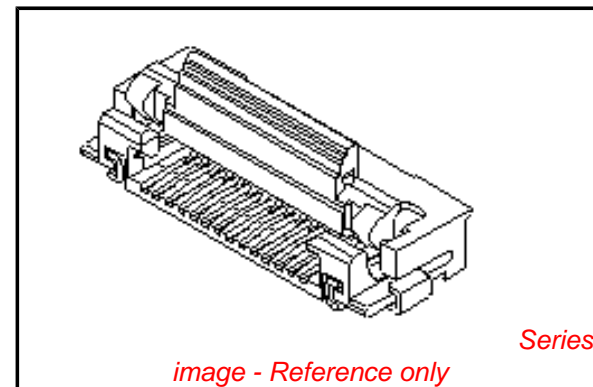

image - Reference only

EU RoHS

ELV and RoHS Compliant
REACH SVHC Contains SVHC: No
Low-Halogen Status
Not Low-Halogen

China RoHS



Need more information on product environmental compliance?

Email productcompliance@molex.com
 For a multiple part number RoHS Certificate of Compliance, [click here](#)

Please visit the [Contact Us](#) section for any non-product compliance questions.

Search Parts in this Series

[52892Series](#)

This document was generated on 03/08/2013

PLEASE CHECK WWW.MOLEX.COM FOR LATEST PART INFORMATION