

# PRODUCT DATA DRAWING

REVISION HISTORY			
REV	DESCRIPTION	DATE	APPROVED
-	DCN 39313	08/12	STW

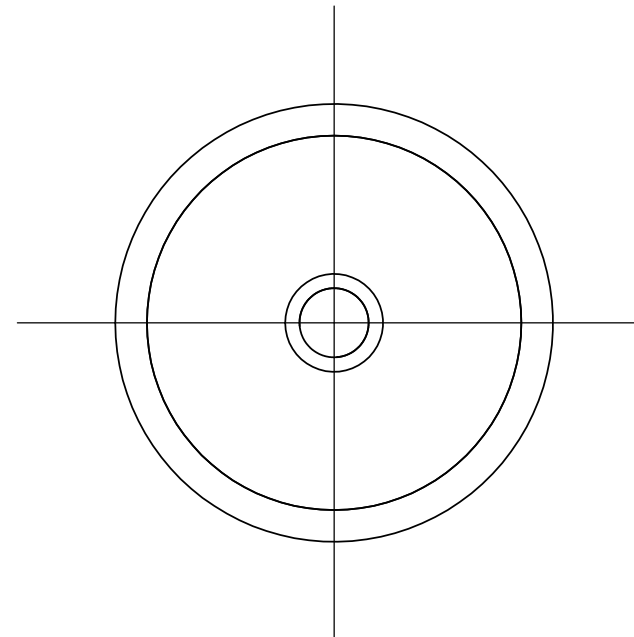
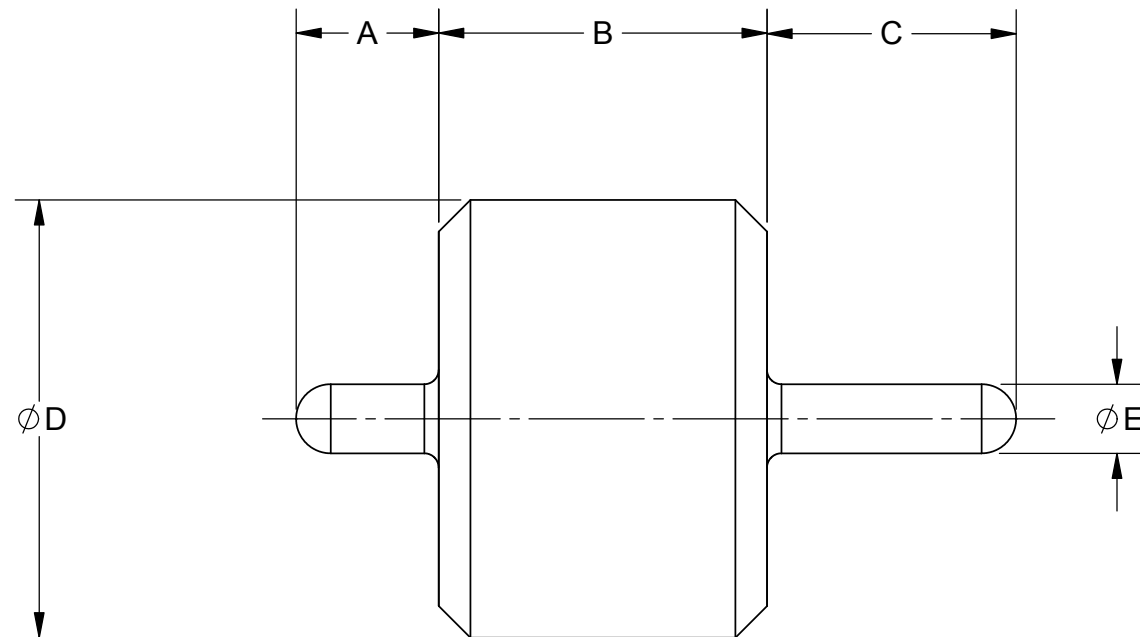

SV PART NUMBER	A	B	C	ØD	ØE
066-15-000	.040	.055	.029	.076	.012
066-15-001	.040	.055	.080	.076	.012
066-15-002	.030	.055	.026	.068	.009
066-15-003	.030	.055	.080	.068	.009
066-15-004	.030	.055	.120	.068	.009
066-15-005	.050	.060	.125	.158	.020

**MATERIAL:**

OUTER RING & PIN: KOVAR PER ASTM F15  
 GLASS SEAL: CORNING #7070 OR EQUIVILANT

**FINISH:**

OUTER RING & PIN: GOLD PER ASTM B488, TYPE II, CODE C, CLASS 1.27, OVER NICKEL PER AMS-QQ-N-290, CLASS 1, .00005" MIN.

MATERIAL: SEE NOTES	DIMENSIONS ARE IN INCHES TOLERANCES: FRACTIONAL: ±1/64 ANGULAR: X° ±1'0" X"X' ±15'	UNLESS OTHERWISE SPECIFIED 1) ALL DIMENSIONS ARE IN INCHES (MILLIMETERS) 2) ALL DIMENSIONS ARE AFTER PLATING. 3) BREAK CORNERS & EDGES .005 R. MAX. 4) CHAM. 1ST & LAST THREADS. 5) SURFACE ROUGHNESS 63-MIL-STD-10. 6) DIA. 'S ON COMMON CENTERS TO BE CONCENTRIC WITHIN .005 T.I.R. 7) REMOVE ALL BURRS	<b>SV Microwave, Inc.</b> 2400 Centrepark West Drive, Suite 100 West Palm Beach, FL 33409
FINISH: SEE NOTES	DECIMAL: X ±.030 .XX ±.010 .XXX ±.005	INTERPRET DIMENSIONS AND TOLERANCES PER ASME Y14.5M - 1994	TITLE: <b>50 OHM HERMETIC SEALS</b>
SURFACE AREA: N/A	THIRD ANGLE PROJECTION	DRAWN: FSG 08/21/12 CHECKED: STW 08/21/12 APPROVED: STW 08/21/12	SIZE: <b>B</b> CAGE CODE: <b>95077</b> DWG. NO. <b>066-15-000-005</b>
<b>PROPRIETARY</b> THE INFORMATION CONTAINED IN THIS DRAWING IS THE SOLE PROPERTY OF SV MICROWAVE, INC. ANY REPRODUCTION IN PART OR AS A WHOLE WITHOUT THE WRITTEN PERMISSION OF SV MICROWAVE, INC IS PROHIBITED.		SCALE: 24:1	SHEET 1 OF 1

# Mouser Electronics

Authorized Distributor

Click to View Pricing, Inventory, Delivery & Lifecycle Information:

[Amphenol:](#)

[066-15-002](#)