



**Important notes about Classic Panel Mount Indicator Catalog Pages**

**SCROLL DOWN TO VIEW CATALOG PAGE**

This catalog page is out-of-print and is used with the understanding that the information shown could be out-of-date. In many cases, part numbers shown on this page are discontinued. Most notably, many “Complete Assembly” parts, which consist of a cap and a base, can no longer be ordered by the 14-digit ordering code. To obtain these parts, please order the cap and base part numbers separately. This process provides the components contained with the original “Complete Assembly” part number.

All Dialight Classic Panel Mount Indicators need a leading 3-digit numerical series. In some cases, this catalog will show a 2-digit series. In this case, please add a leading zero. For example, 81-0211-300 becomes 081-0211-300.

Part numbers listed on Dialight catalog pages designate parts with Red lenses. For ordering lens colors other than red, consult the chart below. In most cases, the color is dictated by the 7<sup>th</sup> digit. For example, 095-0932-003 for a green cap.

Lens Colors	
1 - Red	5 - White
2 - Green	6 - Light Yellow
3 - Yellow	7 - Clear
4 - Blue	

[Click here for a cross reference guide to assembly part numbers.](#)

[Click here to view Frequently Asked Questions concerning Panel Mount Indicators.](#)

**SCROLL DOWN TO VIEW CATALOG PAGE**

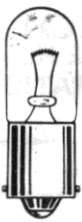

T-3 1/4  
WITH MINIATURE  
BAYONET BASE

See lamp ratings  
on page K.

# Large Incandescent Indicators

FOR MOUNTING IN 1" CLEARANCE HOLE

FOR 2 TO 120V OPERATION

For materials and finishes of products  
in this group, see page 16D.

WITH SCREW-ON LENS CAPS

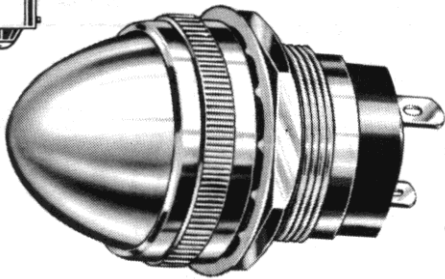

19 SERIES

19-0410-0531-301  
Large Torpedo lens

BASE PART NUMBERS

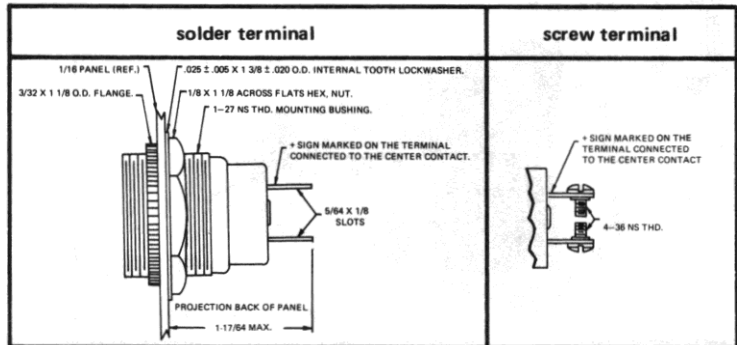

19-0410-05-301

19-1310-05-301

CAP PART NUMBERS

COMPLETE ASSEMBLY PART NUMBERS

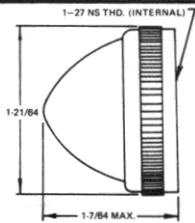

LARGE TORPEDO

19-0511-300 back frosted  
19-0531-300 unfrosted

19-0410-0511-301  
19-0410-0531-301

19-1310-0511-301  
19-1310-0531-301

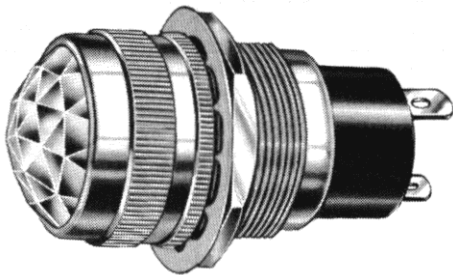

51-0410-0431-301  
Faceted lens

51 SERIES

BASE PART NUMBERS

WITH SCREW-ON LENS CAPS

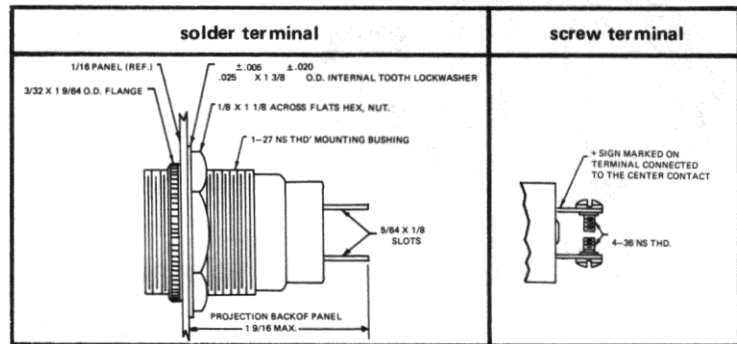

51-0410-01-301

51-1310-01-301

CAP PART NUMBERS

COMPLETE ASSEMBLY PART NUMBERS

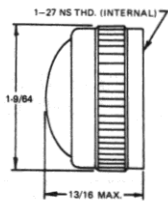

CONVEX

51-0111-300 back frosted  
51-0131-300 unfrosted

51-0410-0111-301  
51-0410-0131-301

51-1310-0111-301  
51-1310-0131-301

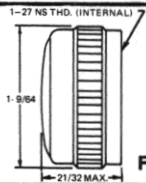

FLAT

51-0211-300 back frosted  
51-0231-300 unfrosted

51-0410-0211-301  
51-0410-0231-301

51-1310-0211-301  
51-1310-0231-301

For legends on flat faced lens, see page P.

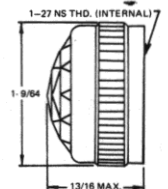

FACETED

51-0431-300 transparent

51-0410-0431-301

51-1310-0431-301

Part numbers listed in this catalog designate products with RED lens.  
For ordering lens colors other than red, consult chart on page 2D.

Part numbers shown in gray are normally  
in inventory at your Dialight Distributor.

# Mouser Electronics

Authorized Distributor

Click to View Pricing, Inventory, Delivery & Lifecycle Information:

Dialight:

[019-0531-300](#) [019-0532-300](#) [019-0533-300](#) [019-0534-300](#) [019-0535-300](#) [019-0536-300](#) [019-0537-300](#) [019-6602-05-300](#) [019-6606-05-300](#)