

PLEASE CHECK WWW.MOLEX.COM FOR LATEST PART INFORMATION

Part Number: [0008701031](#)
Status: **Active**
Overview: SPOX™ BMI Connector System
Description: SPOX™ Crimp Terminal 5194, 18-24 AWG, Brass, Reel

Documents:

Drawing (PDF)	Product Specification PS-5196-004 (PDF)
Product Specification PS-5096-003 (PDF)	Product Specification PS-5196-005 (PDF)
Product Specification PS-5195-001 (PDF)	Product Specification PS-5196-006-001 (PDF)
Product Specification PS-5195-002 (PDF)	Product Specification PS-5197-001 (PDF)
Product Specification PS-5195-003 (PDF)	Product Specification PS-5197-003 (PDF)
Product Specification PS-5195-005-001 (PDF)	Product Specification PS-5197-004 (PDF)
Product Specification PS-5195-006-001 (PDF)	Product Specification PS-5198-001-001 (PDF)
Product Specification PS-5195-007-001 (PDF)	Product Specification PS-5273-003 (PDF)
Product Specification PS-5195-009 (PDF)	Product Specification PS-5273-004 (PDF)
Product Specification PS-5195-010 (PDF)	Packaging Specification 51949200-200 (PDF)
Product Specification PS-5195-011 (PDF)	RoHS Certificate of Compliance (PDF)
Product Specification PS-5196-001 (PDF)	

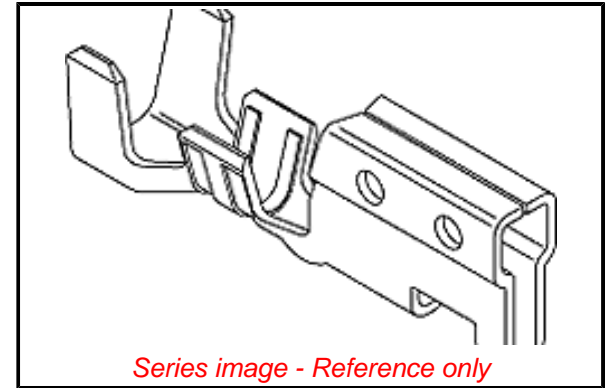

Agency Certification

CSA LR19980

General

Product Family Crimp Terminals
 Series 5194
 Application Signal
 Crimp Quality Equipment Yes
 Overview SPOX™ BMI Connector System
 Packaging Alternative 08-70-1030 (Loose)
 Product Name SPOX™
 UPC 800753534896

Physical

Gender Female
 Material - Metal Brass
 Material - Plating Mating Tin
 Material - Plating Termination Tin
 Net Weight 185.000/mg
 Packaging Type Reel
 Plating min - Mating 0.889µm
 Plating min - Termination 0.889µm
 Termination Interface: Style Crimp or Compression
 Wire Insulation Diameter 1.30-3.20mm
 Wire Size AWG 18, 20, 22, 24
 Wire Size mm² N/A

Material Info

Engineering Number 5194T

Reference - Drawing Numbers

Crimp Specification CS-5194, CS-5194(S)
 Packaging Specification 51949200-200
 Product Specification PS-5096-003, PS-5195-001, PS-5195-002, PS-5195-003, PS-5195-005-001, PS-5195-006-001, PS-5195-007-001, PS-5195-009, PS-5195-010, PS-5195-011, PS-5196-001, PS-5196-004, PS-5196-005, PS-5196-006-001, PS-5197-001,

EU ELV

Not Relevant

EU RoHS

Compliant

REACH SVHC

Not Contained Per
 -ED/01/2017 (12
 January 2017)

Halogen-Free

Status

Low-Halogen

Need more information on product environmental compliance?

Email productcompliance@molex.com
 Please visit the [Contact Us](#) section for any non-product compliance questions.

China ROHS	Green Image
ELV	Not Relevant
RoHS Phthalates	Not Contained

Search Parts in this Series

5194 Series

Use With

5195 , 5196 , 5197 , 5198 , 5199

Sales Drawing

PS-5197-003, PS-5197-004, PS-5198-001-001,
PS-5273-003, PS-5273-004
SD-5194-001

This document was generated on 02/24/2017

PLEASE CHECK WWW.MOLEX.COM FOR LATEST PART INFORMATION