

Types
signal to 2 A

Number of contacts	16-96
Contact spacing (mm)	2.54
Working current see current carrying capacity chart	2 A max. 1 A with insulation displacement 40 A max. type M
Clearance	≥ 1.2 mm
Creepage	≥ 1.2 mm
Working voltage The working voltage also depends on the clearance and creepage dimensions of the pcb itself, and the associated wiring	according to the safety regulations of the equipment Explanations see chapter 00
Test voltage $U_{r.m.s.}$	1 kV
Contact resistance	≤ 15 mΩ for wire wrap connection ≤ 20 mΩ including crimp connection
Insulation resistance	≥ 10 ¹² Ω
Temperature range The higher temperature limit includes the local ambient and heating effects of the contacts under load	- 65 °C ... + 125 °C
Degree of protection for crimp terminal IP 20 according to DIN 40 050	

Electrical termination	
Male connector	Solder pins for pcb connections Ø 1.0 ± 0.1 mm according to IEC 60 326-3 For pcb connection Ø 0.8 + 0.3 mm on request wrap posts 0.6 x 0.6 mm diagonal 0.79-0.86 mm
Female connector	wrap posts 0.6 x 0.6 mm diagonal 0.79-0.86 mm Solder pins for pcb connections Ø 1.0 ± 0.1 mm according to IEC 60 326-3 For pcb connection Ø 0.8 + 0.3 mm on request Solder lugs Crimp terminal 0.09-0.5 mm ² Insulation displacement connection AWG 28/7

Insertion and withdrawal force	16way ≤ 15 N 32way ≤ 30 N 48way ≤ 45 N 64way ≤ 60 N 96way ≤ 90 N
--------------------------------	--

Materials	
Mouldings	Thermoplastic resin, glass-fibre filled, UL 94-V0
Contacts	Copper alloy
Contact surface	Contact zone: selectively plated according to performance level ¹⁾ Termination zone: tinned Wrap posts: selectively gold-plated on request

¹⁾ Explanation performance levels see chapter 00
Mating conditions see chapter 00

Current carrying capacity

The current carrying capacity is limited by maximum temperature of materials for inserts and contacts including terminals. The current capacity curve is valid for continuous, non interrupted current loaded contacts of connectors when simultaneous power on all contacts is given, without exceeding the maximum temperature.

Control and test procedures according to DIN IEC 60 512

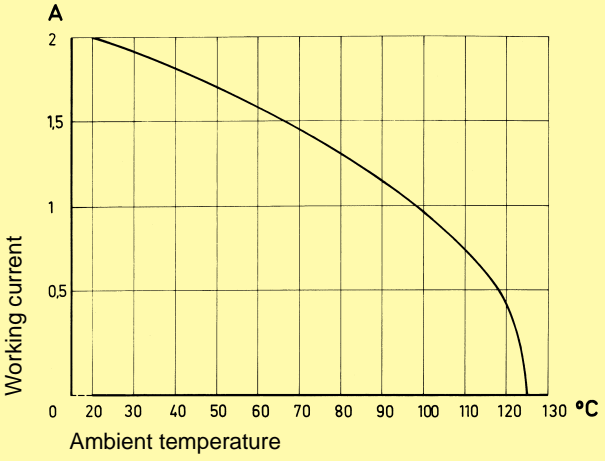

Pin shroud for female connectors with 0.6 x 0.6 mm pins according to DIN 41 612

A secure interfacing system for signals from the rear of 19" racks to connectors with wrap posts 0.6 x 0.6 mm is possible with the use of a pin shroud.

The pin shroud protects the wrap posts on the rear side of the rack and can be screwed to the printed circuit board.

After assembly the rear ends of the wire wrap posts become the mating areas of the type C male connector according to DIN 41 612.

This system can now accept:

- female connectors type C
- female connectors type R

The locking levers provide security for the mated connectors. Fast and simple disconnection is possible.

Fitting and removing crimp contacts

see technical characteristics chapter 02

Number of contacts

64



Female connectors

Types signal to 2 A

Identification	Number of contacts	Part No.	Drawing	Dimensions in mm
----------------	--------------------	----------	---------	------------------

Female connector for insulation displacement

64

Performance level 2
09 02 264 6828

Performance level 3
09 02 264 7828

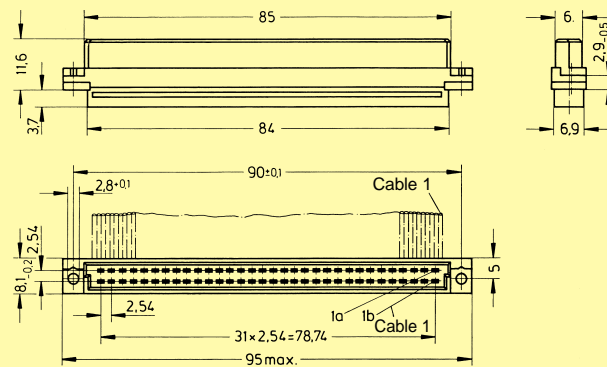

Cable 1 to contact 1 b

Contact arrangement View from termination side

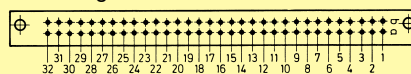

Panel cut out

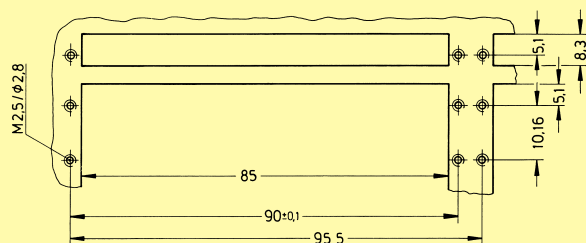

Flat cable
AWG 28/7

grey	30.48 m	64
grey	152.40 m	64
colour coded	30.48 m	64
twisted pair ¹⁾	30.48 m	64

64

09 18 064 7003

09 18 064 7004

09 18 064 7005

09 18 064 7006

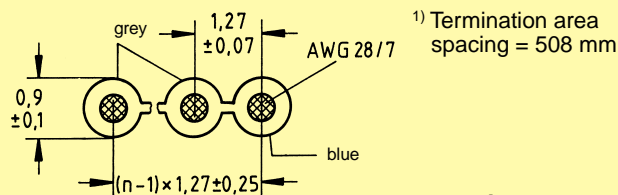

Wire (tinned) Cu
Gauge AWG 28/7 0.089 mm²
Insulation material PVC
as per UL 2651

Important:
always store
reels vertically

Bench press

09 99 000 0114

Base plate

09 99 000 0150

Flat cable cutter

09 99 000 0116

Spare parts

Blade
Cutting plate

09 99 000 0179
09 99 000 0180



Number of contacts

64

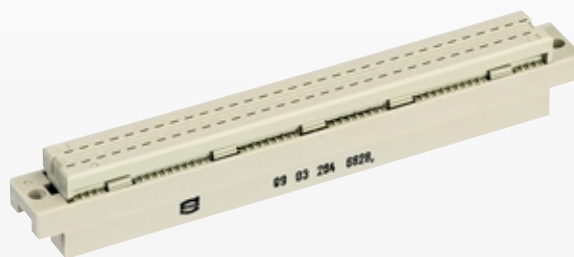

Female connectors

Types signal to 2 A

Identification	Number of contacts	Part No.	Drawing	Dimensions in mm
----------------	--------------------	----------	---------	------------------

Female connector for insulation displacement

64

Performance level 2
09 03 264 6828

Performance level 3
09 03 264 7828

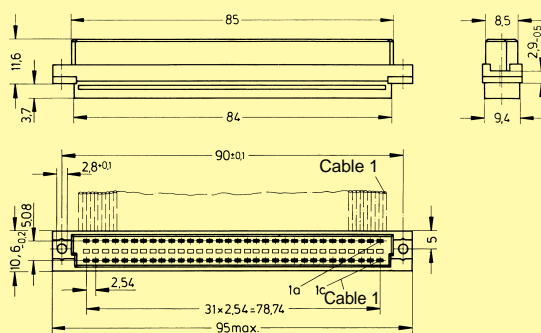

Cable 1 to contact 1 c

Contact arrangement View from termination side

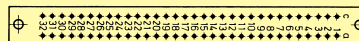

Panel cut out

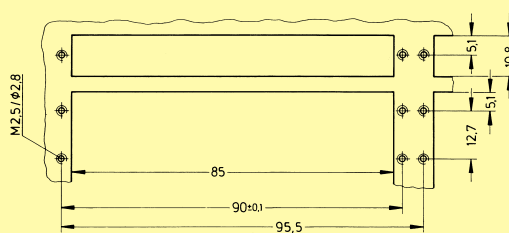

Mateable with 3 row male connector type C, no female contacts in the middle row

Flat cable
AWG 28/7

grey	30.48 m	64	09 18 064 7003
grey	152.40 m	64	09 18 064 7004
colour coded	30.48 m	64	09 18 064 7005
twisted pair ¹⁾	30.48 m	64	09 18 064 7006

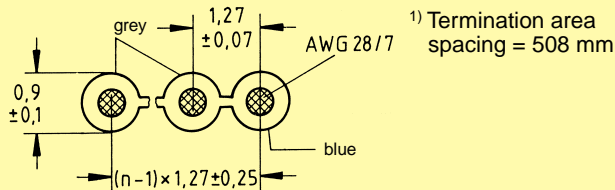

¹⁾ Termination area spacing = 508 mm

Wire (tinned) Cu
Gauge AWG 28/7 0.089 mm²
Insulation material PVC
as per UL 2651

Important:
always store reels vertically

Bench press

09 99 000 0114

Base plate

09 99 000 0150

Flat cable cutter

09 99 000 0116

Spare parts

Blade

09 99 000 0179

Cutting plate

09 99 000 0180

