

Bridgelux® Gen 7 V13 Array

Product Data Sheet DS101



BXRE-27x2000

| 30x2000

| 35x2000

| 40x2000

| 50x2001

| 57x2001

| 65x2001

Introduction

V Series

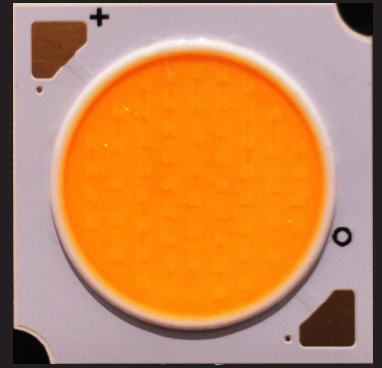

The V Series™ LED Array products deliver high quality light in a compact and cost-effective solid-state lighting package. These Chip-on-Board (CoB) arrays can be efficiently driven at twice the nominal drive current, enabling design flexibility not previously possible. This high flux density light source is designed to support a wide range of high quality, low cost directional luminaires and replacement lamps for commercial and residential applications.

The V13 LED Array is available in a variety of electrical, CCT and CRI combinations providing substantial design flexibility and energy efficiencies.

Lighting system designs incorporating these LED Arrays deliver increased system level efficacy and longer service life. Typical applications include, but are not limited to, replacement lamps, task, accent, spot, track, down light, wide area, security, and wall pack.

Features

- Efficacy of 155 lm/W typical
- Compact high flux density light source
- Uniform high quality illumination
- Minimum 70, 80 and 90 CRI options
- Streamlined thermal path
- ENERGY STAR® / ANSI compliant color binning structure with 3 SDCM and 4 SDCM options
- More energy efficient than incandescent, halogen and fluorescent lamps
- Low voltage DC operation
- Instant light with unlimited dimming

Benefits

- Enhanced optical control
- Clean white light without pixilation
- High quality true color reproduction
- Significantly reduced thermal resistance and increased operating temperatures
- Uniform consistent white light
- Lower operating costs
- Easy to use with daylight and motion detectors to enable increased energy savings
- Reduced maintenance costs
- Environmentally friendly, no disposal issue



Pending Standards and Classifications: ENEC

Contents

Product Feature Map	2
Product Nomenclature	2
Product Selection Guide	3
Performance at Commonly Used Drive Currents	5
Electrical Characteristics	9
Absolute Maximum Ratings	10
Performance Curves	11
Typical Radiation Pattern	15
Typical Color Spectrum	16
Mechanical Dimensions	17
Color Binning Information	18
Packaging and Labeling	19
Design Resources	21
Precautions	21
Disclaimers	21
About Bridgelux	22

Product Feature Map

Bridgelux arrays are fully engineered devices that provide consistent thermal and optical performance on an engineered mechanical platform. The V Series arrays are the most compact chip-on-board devices across all of

Bridgelux's LED Array products. The arrays incorporate several features to simplify design integration and assembly.

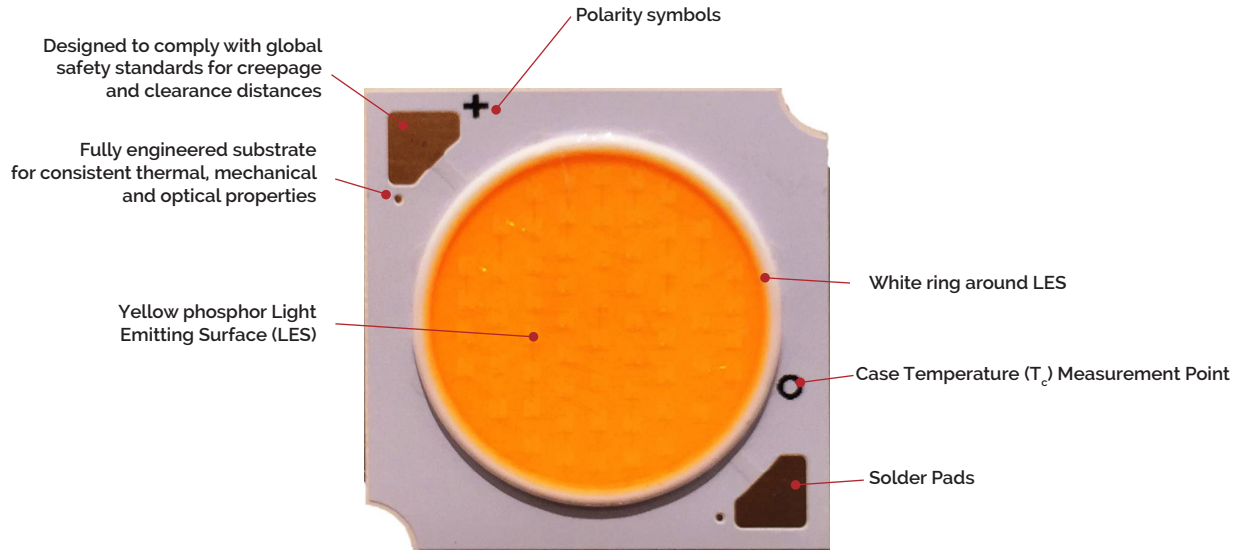

Note: Part number and lot codes are scribed on back of array

Product Nomenclature

The part number designation for Bridgelux V13 LED arrays is explained as follows:

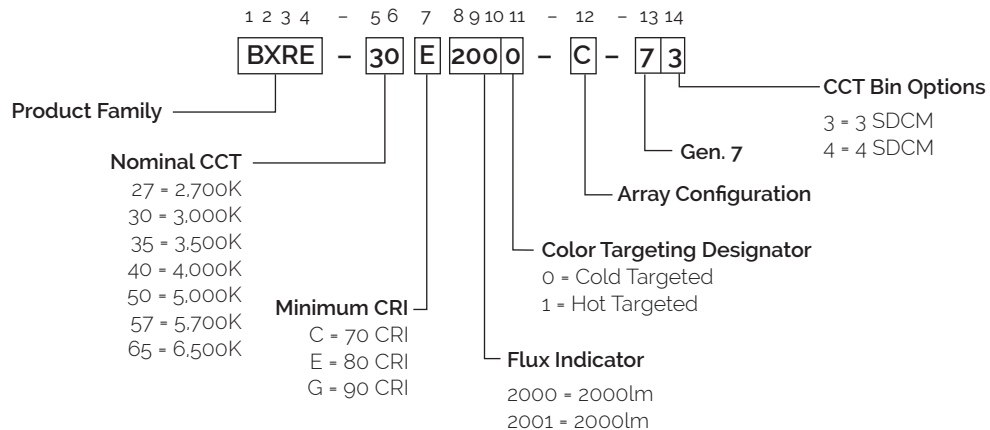

Product Selection Guide

The following product configurations are available:

Table 1: Selection Guide, Pulsed Measurement Data ($T_j = T_c = 25^\circ\text{C}$)

Part Number	Nominal CCT ¹ (K)	CRI ²	Nominal Drive Current ³ (mA)	Typical Pulsed Flux ^{4,5,6} $T_c = 25^\circ\text{C}$ (lm)	Minimum Pulsed Flux ^{6,7} $T_c = 25^\circ\text{C}$ (lm)	Typical V_f (V)	Typical Power (W)	Typical Efficacy (lm/W)
BXRE-27E2000-B-7X	2700	80	450	2323	2189	34.8	15.6	149
BXRE-27E2000-C-7X	2700	80	630	3251	2991	34.8	21.9	149
BXRE-27G2000-B-7X	2700	90	450	1936	1824	34.8	15.6	124
BXRE-27G2000-C-7X	2700	90	630	2709	2493	34.8	21.9	124
BXRE-30E2000-B-7X	3000	80	450	2420	2280	34.8	15.6	155
BXRE-30E2000-C-7X	3000	80	630	3387	3116	34.8	21.9	155
BXRE-30G2000-B-7X	3000	90	450	2008	1860	34.8	15.6	128
BXRE-30G2000-C-7X	3000	90	630	2811	2586	34.8	21.9	128
BXRE-35E2000-B-7X	3500	80	450	2492	2348	34.8	15.6	159
BXRE-35E2000-C-7X	3500	80	630	3488	3209	34.8	21.9	159
BXRE-35G2000-B-7X	3500	90	450	2081	1961	34.8	15.6	133
BXRE-35G2000-C-7X	3500	90	630	2913	2680	34.8	21.9	133
BXRE-40E2000-B-7X	4000	80	450	2516	2350	34.8	15.6	161
BXRE-40E2000-C-7X	4000	80	630	3522	3240	34.8	21.9	161
BXRE-40G2000-B-7X	4000	90	450	2153	2029	34.8	15.6	138
BXRE-40G2000-C-7X	4000	90	630	3014	2773	34.8	21.9	138
BXRE-50C2001-B-74	5000	70	450	2758	2599	34.8	15.6	176
BXRE-50C2001-C-74	5000	70	630	3861	3552	34.8	21.9	176
BXRE-50E2001-B-74	5000	80	450	2593	2443	34.8	15.6	166
BXRE-50E2001-C-74	5000	80	630	3629	3339	34.8	21.9	166
BXRE-50G2001-B-74	5000	90	450	2207	2079	34.8	15.6	141
BXRE-50G2001-C-74	5000	90	630	3089	2842	34.8	21.9	141
BXRE-57C2001-B-74	5700	70	450	2662	2508	34.8	15.6	170
BXRE-57C2001-C-74	5700	70	630	3725	3427	34.8	21.9	170
BXRE-57E2001-B-74	5700	80	450	2637	2485	34.8	15.6	169
BXRE-57E2001-C-74	5700	80	630	3692	3396	34.8	21.9	169
BXRE-65C2001-B-74	6500	70	450	2710	2554	34.8	15.6	173
BXRE-65C2001-C-74	6500	70	630	3793	3490	34.8	21.9	173
BXRE-65E2001-B-74	6500	80	450	2686	2531	34.8	15.6	172
BXRE-65E2001-C-74	6500	80	630	3759	3459	34.8	21.9	172

Notes for Tables 1:

1. Nominal CCT as defined by ANSI C78.377-2011. Products with CCTs 5000K-6500K are hot targeted to 85°C .
2. CRI values are minimums. Minimum R_g value for 80 CRI products is 0, the minimum R_g values for 90 CRI products is 50.
3. Drive current is referred to as nominal drive current.
4. Products tested under pulsed condition (10ms pulse width) at nominal test current where T_j (junction temperature) = T_c (case temperature) = 25°C .
5. Typical performance values are provided as a reference only and are not a guarantee of performance.
6. Bridgelux maintains a $\pm 7\%$ tolerance on flux measurements.
7. Minimum flux values at the nominal test current are guaranteed by 100% test.

Product Selection Guide

Table 2: Selection Guide, Stabilized DC Performance ($T_c = 85^\circ\text{C}$)^{4,5}

Part Number	Nominal CCT ¹ (K)	CRI ²	Nominal Drive Current ³ (mA)	Typical DC Flux ^{4,5} $T_c = 85^\circ\text{C}$ (lm)	Minimum DC Flux ⁶ $T_c = 85^\circ\text{C}$ (lm)	Typical V_f (V)	Typical Power (W)	Typical Efficacy (lm/W)
BXRE-27E2000-B-7X	2700	80	450	2090	1970	33.9	15.3	137
BXRE-27E2000-C-7X	2700	80	630	2926	2692	33.9	21.4	137
BXRE-27G2000-B-7X	2700	90	450	1742	1642	33.9	15.3	114
BXRE-27G2000-C-7X	2700	90	630	2438	2243	33.9	21.4	114
BXRE-30E2000-B-7X	3000	80	450	2178	2052	33.9	15.3	143
BXRE-30E2000-C-7X	3000	80	630	3048	2804	33.9	21.4	143
BXRE-30G2000-B-7X	3000	90	450	1807	1674	33.9	15.3	118
BXRE-30G2000-C-7X	3000	90	630	2530	2328	33.9	21.4	118
BXRE-35E2000-B-7X	3500	80	450	2243	2114	33.9	15.3	147
BXRE-35E2000-C-7X	3500	80	630	3140	2888	33.9	21.4	147
BXRE-35G2000-B-7X	3500	90	450	1873	1765	33.9	15.3	123
BXRE-35G2000-C-7X	3500	90	630	2621	2412	33.9	21.4	123
BXRE-40E2000-B-7X	4000	80	450	2265	2115	33.9	15.3	148
BXRE-40E2000-C-7X	4000	80	630	3170	2916	33.9	21.4	148
BXRE-40G2000-B-7X	4000	90	450	1938	1826	33.9	15.3	127
BXRE-40G2000-C-7X	4000	90	630	2713	2496	33.9	21.4	127
BXRE-50C2001-B-74	5000	70	450	2482	2339	33.9	15.3	163
BXRE-50C2001-C-74	5000	70	630	3475	3197	33.9	21.4	163
BXRE-50E2001-B-74	5000	80	450	2334	2199	33.9	15.3	153
BXRE-50E2001-C-74	5000	80	630	3266	3005	33.9	21.4	153
BXRE-50G2001-B-74	5000	90	450	1986	1871	33.9	15.3	130
BXRE-50G2001-C-74	5000	90	630	2780	2557	33.9	21.4	130
BXRE-57C2001-B-74	5700	70	450	2395	2257	33.9	15.3	157
BXRE-57C2001-C-74	5700	70	630	3353	3085	33.9	21.4	157
BXRE-57E2001-B-74	5700	80	450	2374	2237	33.9	15.3	156
BXRE-57E2001-C-74	5700	80	630	3322	3057	33.9	21.4	156
BXRE-65C2001-B-74	6500	70	450	2439	2298	33.9	15.3	160
BXRE-65C2001-C-74	6500	70	630	3414	3141	33.9	21.4	160
BXRE-65E2001-B-74	6500	80	450	2417	2278	33.9	15.3	158
BXRE-65E2001-C-74	6500	80	630	3383	3113	33.9	21.4	158

Notes for Tables 2:

- Nominal CCT as defined by ANSI C78.377-2011. Products with a CCT of 5000K-6500K are hot targeted to 85°C.
- CRI values are minimums. Minimum Rg value for 80 CRI products is 0, the minimum Rg values for 90 CRI products is 50.
- Drive current is referred to as nominal drive current.
- Typical stabilized DC performance values are provided as reference only and are not a guarantee of performance.
- Typical performance is estimated based on operation under DC (direct current) with LED array mounted onto a heat sink with thermal interface material and the case temperature maintained at 85°C. Based on Bridgelux test setup, values may vary depending on the thermal design of the luminaire and/or the exposed environment to which the product is subjected.
- Minimum flux values at elevated temperatures are provided for reference only and are not guaranteed by 100% production testing. Based on Bridgelux test setup, values may vary depending on the thermal design of the luminaire and/or the exposed environment to which the product is subjected.

Performance at Commonly Used Drive Currents

V Series LED arrays are tested to the specifications shown using the nominal drive currents in Table 1. V Series may also be driven at other drive currents dependent on specific application design requirements. The performance at any drive current can be derived from the current vs. voltage characteristics shown in Figures 1 & 2 and the flux vs. current characteristics shown in Figures 3 & 4. The performance at commonly used drive currents is summarized in Table 3.

Table 3: Product Performance at Commonly Used Drive Currents

Part Number	CRI	Drive Current ¹ (mA)	Typical V_f $T_c = 25^\circ\text{C}$ (V)	Typical Power $T_c = 25^\circ\text{C}$ (W)	Typical Flux ² $T_c = 25^\circ\text{C}$ (lm)	Typical DC Flux ³ $T_c = 85^\circ\text{C}$ (lm)	Typical Efficacy $T_c = 25^\circ\text{C}$ (lm/W)
BXRE-27E2000-B-7X	80	113	32.3	3.6	637	588	175
		225	33.2	7.5	1228	1127	165
		450	34.8	15.6	2323	2090	149
		675	36.0	24.3	3361	3050	138
		900	37.2	33.5	4286	3871	128
BXRE-27E2000-C-7X	80	158	32.3	5.1	884	837	174
		315	33.2	10.4	1706	1608	163
		630	34.8	21.9	3251	2926	149
		945	36.1	34.1	4672	4369	137
		1260	37.3	47.0	5961	5556	127
BXRE-27G2000-B-7X	90	113	32.3	3.6	530	490	146
		225	33.2	7.5	1024	939	137
		450	34.8	15.6	1936	1742	124
		675	36.0	24.3	2801	2542	115
		900	37.2	33.5	3571	3226	107
BXRE-27G2000-C-7X	90	158	32.3	5.1	737	698	145
		315	33.2	10.4	1422	1340	136
		630	34.8	21.9	2709	2438	124
		945	36.1	34.1	3893	3641	114
		1260	37.3	47.0	4968	4630	106
BXRE-30E2000-B-7X	80	113	32.3	3.6	663	612	182
		225	33.2	7.5	1280	1174	171
		450	34.8	15.6	2420	2178	155
		675	36.0	24.3	3501	3177	144
		900	37.2	33.5	4464	4032	133
BXRE-30E2000-C-7X	80	158	32.3	5.1	921	872	181
		315	33.2	10.4	1777	1675	170
		630	34.8	21.9	3387	3048	155
		945	36.1	34.1	4867	4551	143
		1260	37.3	47.0	6210	5788	132

Notes for Table 3:

1. Alternate drive currents in Table 3 are provided for reference only and are not a guarantee of performance.
2. Bridgelux maintains a $\pm 7\%$ tolerance on flux measurements.
3. Typical stabilized DC performance values are provided as reference only and are not a guarantee of performance.

Performance at Commonly Used Drive Currents

Table 3: Product Performance at Commonly Used Drive Currents (Continued)

Part Number	CRI	Drive Current ¹ (mA)	Typical V_f $T_c = 25^\circ\text{C}$ (V)	Typical Power $T_c = 25^\circ\text{C}$ (W)	Typical Flux ² $T_c = 25^\circ\text{C}$ (lm)	Typical DC Flux ³ $T_c = 85^\circ\text{C}$ (lm)	Typical Efficacy $T_c = 25^\circ\text{C}$ (lm/W)
BXRE-30G2000-B-7X	90	113	32.3	3.6	550	508	151
		225	33.2	7.5	1062	974	142
		450	34.8	15.6	2008	1807	128
		675	36.0	24.3	2906	2637	119
		900	37.2	33.5	3705	3347	111
BXRE-30G2000-C-7X	90	158	32.3	5.1	764	724	150
		315	33.2	10.4	1475	1390	141
		630	34.8	21.9	2811	2530	128
		945	36.1	34.1	4039	3778	118
		1260	37.3	47.0	5154	4804	110
BXRE-35E2000-B-7X	80	113	32.3	3.6	683	630	188
		225	33.2	7.5	1318	1209	177
		450	34.8	15.6	2492	2243	159
		675	36.0	24.3	3606	3273	148
		900	37.2	33.5	4598	4153	137
BXRE-35E2000-C-7X	80	158	32.3	5.1	948	898	186
		315	33.2	10.4	1831	1726	175
		630	34.8	21.9	3488	3140	159
		945	36.1	34.1	5013	4688	147
		1260	37.3	47.0	6396	5962	136
BXRE-35G2000-B-7X	90	113	32.3	3.6	570	526	157
		225	33.2	7.5	1100	1010	147
		450	34.8	15.6	2081	1873	133
		675	36.0	24.3	3011	2733	124
		900	37.2	33.5	3839	3468	115
BXRE-35G2000-C-7X	90	158	32.3	5.1	792	750	156
		315	33.2	10.4	1528	1441	146
		630	34.8	21.9	2913	2621	133
		945	36.1	34.1	4185	3914	123
		1260	37.3	47.0	5340	4978	114
BXRE-40E2000-B-7X	80	113	32.3	3.6	690	636	190
		225	33.2	7.5	1331	1221	178
		450	34.8	15.6	2516	2265	161
		675	36.0	24.3	3641	3305	150
		900	37.2	33.5	4643	4193	139
BXRE-40E2000-C-7X	80	158	32.3	5.1	958	907	188
		315	33.2	10.4	1848	1742	177
		630	34.8	21.9	3522	3170	161
		945	36.1	34.1	5061	4733	148
		1260	37.3	47.0	6458	6019	137
BXRE-40G2000-B-7X	90	113	32.3	3.6	590	545	162
		225	33.2	7.5	1139	1045	153
		450	34.8	15.6	2153	1938	138
		675	36.0	24.3	3116	2828	128
		900	37.2	33.5	3973	3589	119

Notes for Table 3:

1. Alternate drive currents in Table 3 are provided for reference only and are not a guarantee of performance.
2. Bridgelux maintains a $\pm 7\%$ tolerance on flux measurements.
3. Typical stabilized DC performance values are provided as reference only and are not a guarantee of performance.

Performance at Commonly Used Drive Currents

Table 3: Product Performance at Commonly Used Drive Currents (Continued)

Part Number	CRI	Drive Current ¹ (mA)	Typical V_f $T_c = 25^\circ\text{C}$ (V)	Typical Power $T_c = 25^\circ\text{C}$ (W)	Typical Flux ² $T_c = 25^\circ\text{C}$ (lm)	Typical DC Flux ³ $T_c = 85^\circ\text{C}$ (lm)	Typical Efficacy $T_c = 25^\circ\text{C}$ (lm/W)
BXRE-40G2000-C-7X	90	158	32.3	5.1	820	776	161
		315	33.2	10.4	1582	1491	151
		630	34.8	21.9	3014	2713	138
		945	36.1	34.1	4331	4051	127
		1260	37.3	47.0	5527	5151	118
BXRE-50C2001-B-74	70	113	32.3	3.6	756	698	208
		225	33.2	7.5	1459	1338	195
		450	34.8	15.6	2758	2482	176
		675	36.0	24.3	3991	3622	164
		900	37.2	33.5	5089	4597	152
BXRE-50C2001-C-74	70	158	32.3	5.1	1050	994	206
		315	33.2	10.4	2026	1910	194
		630	34.8	21.9	3861	3475	176
		945	36.1	34.1	5548	5189	163
		1260	37.3	47.0	7079	6598	151
BXRE-50E2001-B-74	80	113	32.3	3.6	711	656	195
		225	33.2	7.5	1371	1258	184
		450	34.8	15.6	2593	2334	166
		675	36.0	24.3	3751	3405	154
		900	37.2	33.5	4784	4321	143
BXRE-50E2001-C-74	80	158	32.3	5.1	987	935	194
		315	33.2	10.4	1904	1795	182
		630	34.8	21.9	3629	3266	166
		945	36.1	34.1	5215	4877	153
		1260	37.3	47.0	6655	6202	142
BXRE-50G2001-B-74	90	113	32.3	3.6	605	558	166
		225	33.2	7.5	1167	1071	156
		450	34.8	15.6	2207	1986	141
		675	36.0	24.3	3193	2898	131
		900	37.2	33.5	4071	3677	122
BXRE-50G2001-C-74	90	158	32.3	5.1	840	795	165
		315	33.2	10.4	1621	1528	155
		630	34.8	21.9	3089	2780	141
		945	36.1	34.1	4438	4151	130
		1260	37.3	47.0	5663	5279	120
BXRE-57C2001-B-74	70	113	32.3	3.6	729	673	201
		225	33.2	7.5	1408	1291	189
		450	34.8	15.6	2662	2395	170
		675	36.0	24.3	3851	3495	158
		900	37.2	33.5	4911	4435	147
BXRE-57C2001-C-74	70	158	32.3	5.1	1013	959	199
		315	33.2	10.4	1955	1843	187
		630	34.8	21.9	3725	3353	170
		945	36.1	34.1	5353	5007	157
		1260	37.3	47.0	6831	6367	145

Notes for Table 3:

1. Alternate drive currents in Table 3 are provided for reference only and are not a guarantee of performance.
2. Bridgelux maintains a $\pm 7\%$ tolerance on flux measurements.
3. Typical stabilized DC performance values are provided as reference only and are not a guarantee of performance.

Performance at Commonly Used Drive Currents

Table 3: Product Performance at Commonly Used Drive Currents (Continued)

Part Number	CRI	Drive Current ¹ (mA)	Typical V_f $T_c = 25^\circ\text{C}$ (V)	Typical Power $T_c = 25^\circ\text{C}$ (W)	Typical Flux ² $T_c = 25^\circ\text{C}$ (lm)	Typical DC Flux ³ $T_c = 85^\circ\text{C}$ (lm)	Typical Efficacy $T_c = 25^\circ\text{C}$ (lm/W)
BXRE-57E2001-B-74	80	113	32.3	3.6	723	667	199
		225	33.2	7.5	1395	1280	187
		450	34.8	15.6	2637	2374	169
		675	36.0	24.3	3816	3463	157
		900	37.2	33.5	4866	4395	145
BXRE-57E2001-C-74	80	158	32.3	5.1	1004	951	197
		315	33.2	10.4	1937	1826	185
		630	34.8	21.9	3692	3322	169
		945	36.1	34.1	5305	4961	155
		1260	37.3	47.0	6769	6309	144
BXRE-65C2001-B-74	70	113	32.3	3.6	743	685	204
		225	33.2	7.5	1433	1315	192
		450	34.8	15.6	2710	2439	173
		675	36.0	24.3	3921	3559	161
		900	37.2	33.5	5000	4516	149
BXRE-65C2001-C-74	70	158	32.3	5.1	1031	977	203
		315	33.2	10.4	1990	1876	191
		630	34.8	21.9	3793	3414	173
		945	36.1	34.1	5451	5098	160
		1260	37.3	47.0	6955	6482	148
BXRE-65E2001-B-74	80	113	32.3	3.6	736	679	202
		225	33.2	7.5	1420	1303	190
		450	34.8	15.6	2686	2417	172
		675	36.0	24.3	3886	3527	160
		900	37.2	33.5	4955	4476	148
BXRE-65E2001-C-74	80	158	32.3	5.1	1022	968	201
		315	33.2	10.4	1973	1860	189
		630	34.8	21.9	3759	3383	172
		945	36.1	34.1	5402	5052	158
		1260	37.3	47.0	6893	6425	147

Notes for Table 3:

1. Alternate drive currents in Table 3 are provided for reference only and are not a guarantee of performance.
2. Bridgelux maintains a $\pm 7\%$ tolerance on flux measurements.
3. Typical stabilized DC performance values are provided as reference only and are not a guarantee of performance.

Electrical Characteristics

Table 4: Electrical Characteristics

Part Number	Drive Current (mA)	Forward Voltage Pulsed, $T_c = 25^\circ\text{C}$ (V) ^{1,2,3}			Typical Coefficient of Forward Voltage ⁴ $\Delta V_f / \Delta T_c$ (mV/ $^\circ\text{C}$)	Typical Thermal Resistance Junction to Case ^{5,6} R_{j-c} ($^\circ\text{C}/\text{W}$)	Driver Selection Voltages ⁷ (V)	
		Minimum	Typical	Maximum			V_f Min. Hot $T_c = 105^\circ\text{C}$ (V)	V_f Max. Cold $T_c = -40^\circ\text{C}$ (V)
BXRE-xxx200x-B-7x	450	32.1	34.8	37.4	-14.2	0.28	31.0	38.3
	900	34.4	37.2	40.0	-14.2	0.34	33.3	40.9
BXRE-xxx200x-C-7x	630	32.1	34.8	37.4	-14.2	0.20	31.0	38.3
	1260	34.5	37.3	40.1	-14.2	0.24	33.4	41.0

Notes for Table 4:

- Parts are tested in pulsed conditions, $T_c = 25^\circ\text{C}$. Pulse width is 10ms.
- Voltage minimum and maximum are provided for reference only and are not a guarantee of performance.
- Bridgelux maintains a tester tolerance of $\pm 0.10\text{V}$ on forward voltage measurements.
- Typical coefficient of forward voltage tolerance is $\pm 0.1\text{mV}$ for nominal current.
- Thermal resistance values are based from test data of a 3000K 80 CRI product.
- Thermal resistance value was calculated using total electrical input power; optical power was not subtracted from input power. The thermal interface material used during testing is not included in the thermal resistance value.
- V_f min hot and max cold values are provided as reference only and are not guaranteed by test. These values are provided to aid in driver design and selection over the operating range of the product.

Absolute Maximum Ratings

Table 5: Maximum Ratings

Parameter	Maximum Rating	
LED Junction Temperature (T_j)	125°C	
Storage Temperature	-40°C to +105°C	
Operating Case Temperature ¹ (T_c)	105°C	
Soldering Temperature ²	350°C or lower for a maximum of 10 seconds	
	BXRE-xxx200x-B-7x	BXRE-xxx200x-C-7x
Maximum Drive Current ³	900mA	1260mA
Maximum Peak Pulsed Drive Current ⁴	1286mA	1800mA
Maximum Reverse Voltage ⁵	-60V	-60V

Notes for Table 5:

1. For IEC 62717 requirement, please consult your Bridgelux sales representative.
2. Refer to Bridgelux Application Note AN41: Handling and Assembly of Bridgelux V Series LED Arrays
3. Arrays may be driven at higher currents however lumen maintenance may be reduced.
4. Bridgelux recommends a maximum duty cycle of 10% and pulse width of 20 ms when operating LED Arrays at maximum peak pulsed current specified. Maximum peak pulsed currents indicate values where LED Arrays can be driven without catastrophic failures.
5. Light emitting diodes are not designed to be driven in reverse voltage and will not produce light under this condition. Maximum rating provided for reference only.

Performance Curves

Figure 1: V13B Drive Current vs. Voltage ($T_j = T_c = 25^\circ\text{C}$)

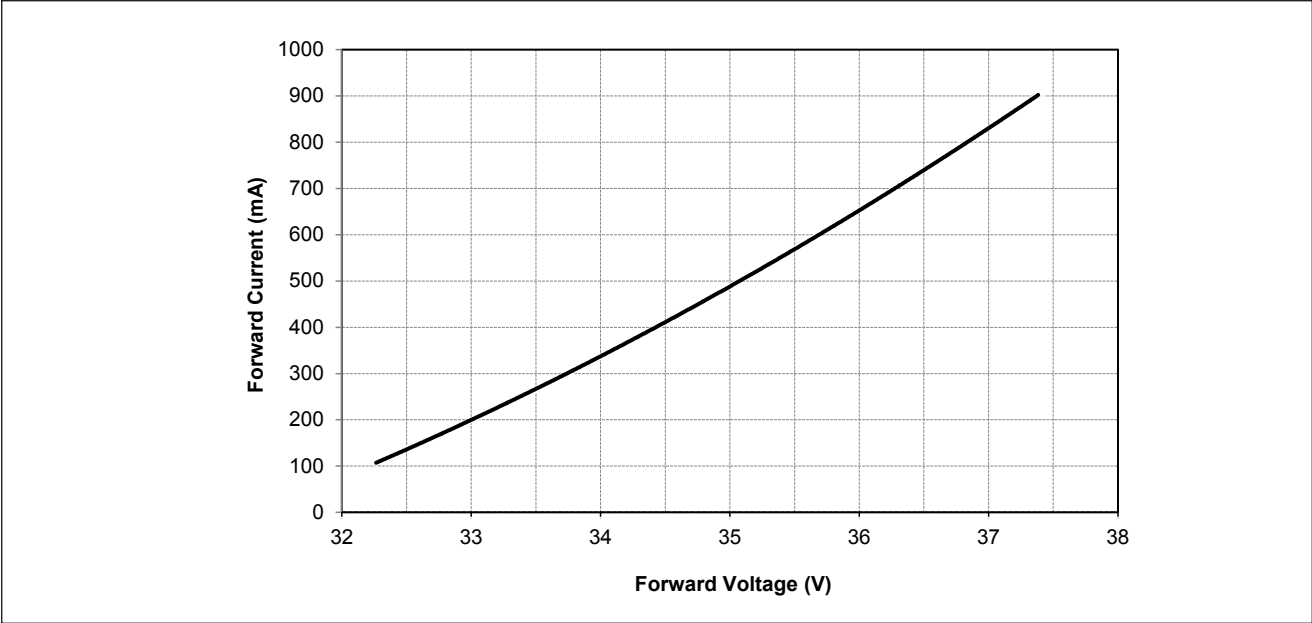
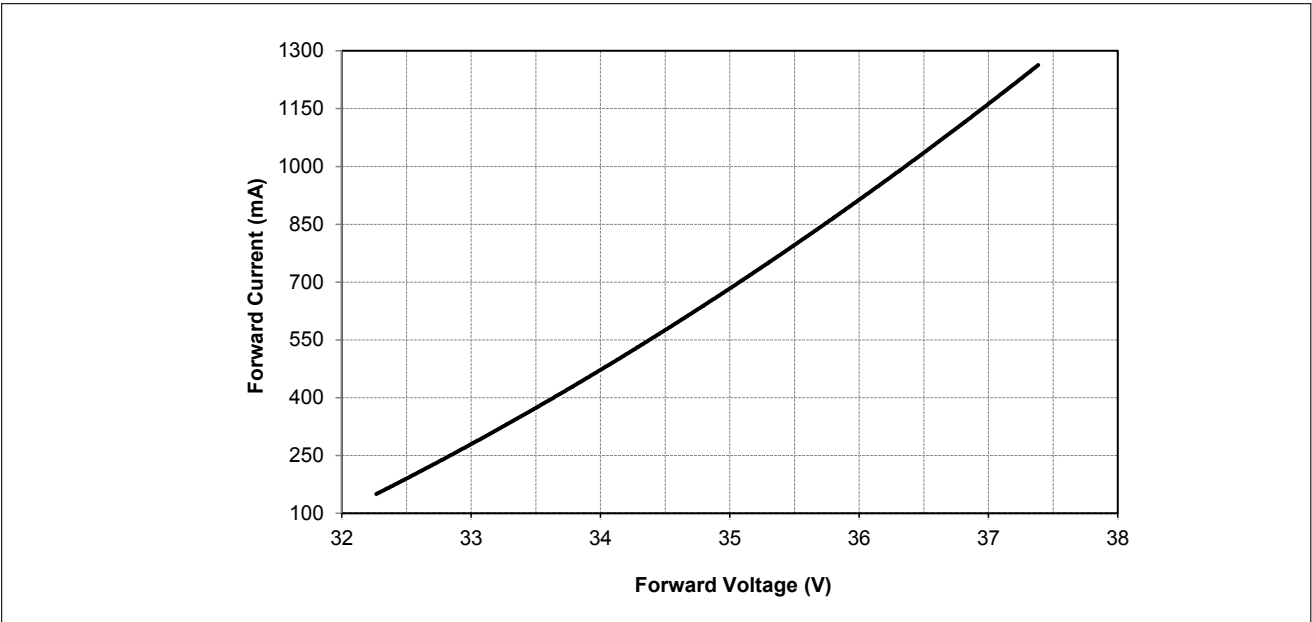

Figure 2: V13C Drive Current vs. Voltage ($T_j = T_c = 25^\circ\text{C}$)



Performance Curves

Figure 3: V13B Typical Relative Flux vs. Current ($T_j = T_c = 25^\circ\text{C}$)

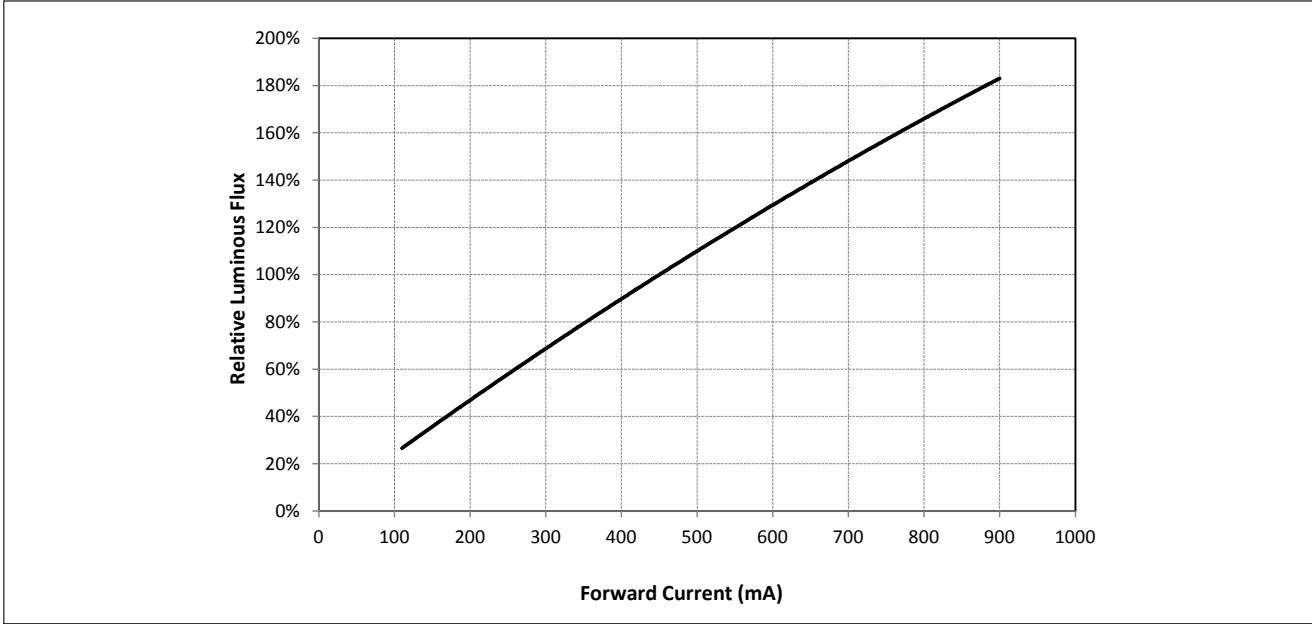
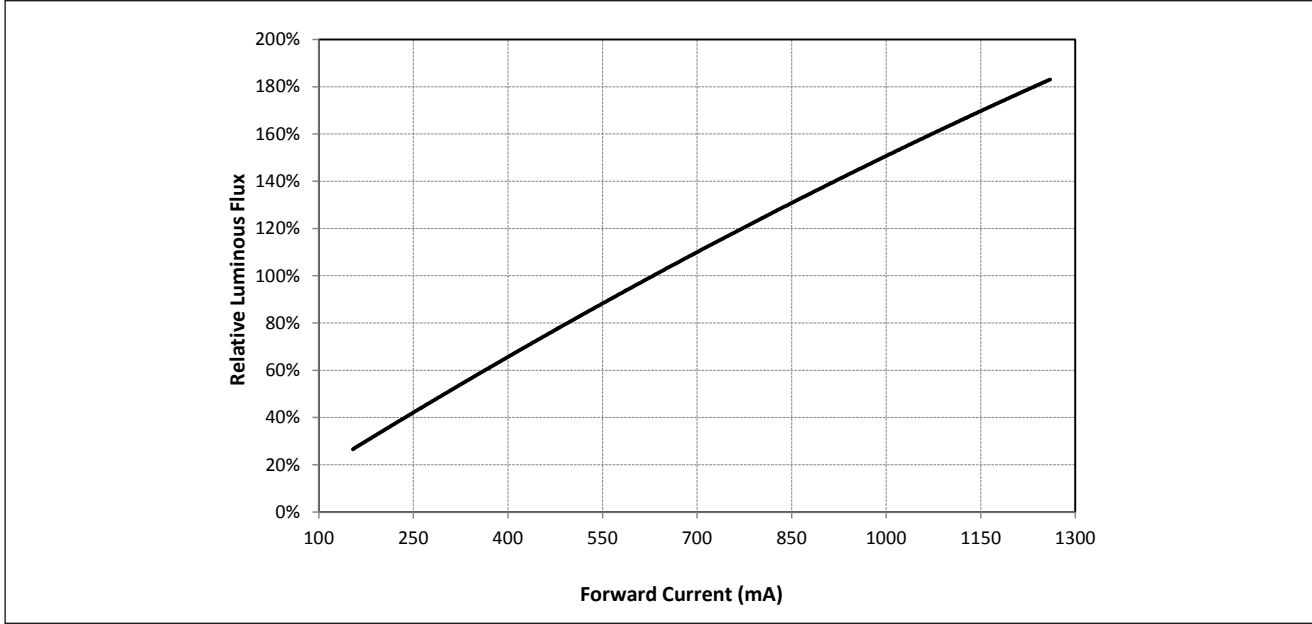

Figure 4: V13C Typical Relative Flux vs. Current ($T_j = T_c = 25^\circ\text{C}$)



Note for Figures 3 & 4:
1. Bridgelux does not recommend driving high power LEDs at low currents. Doing so may produce unpredictable results. Pulse width modulation (PWM) is recommended for dimming effects.

Performance Curves

Figure 5: Typical DC Flux vs. Case Temperature

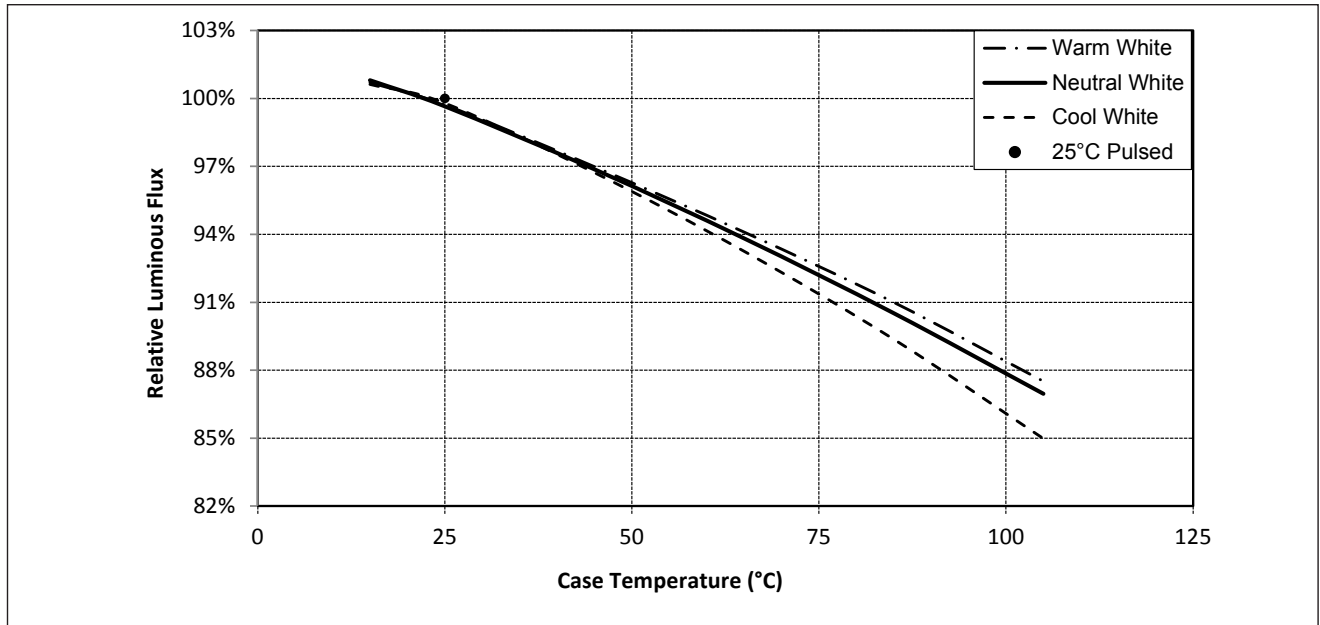
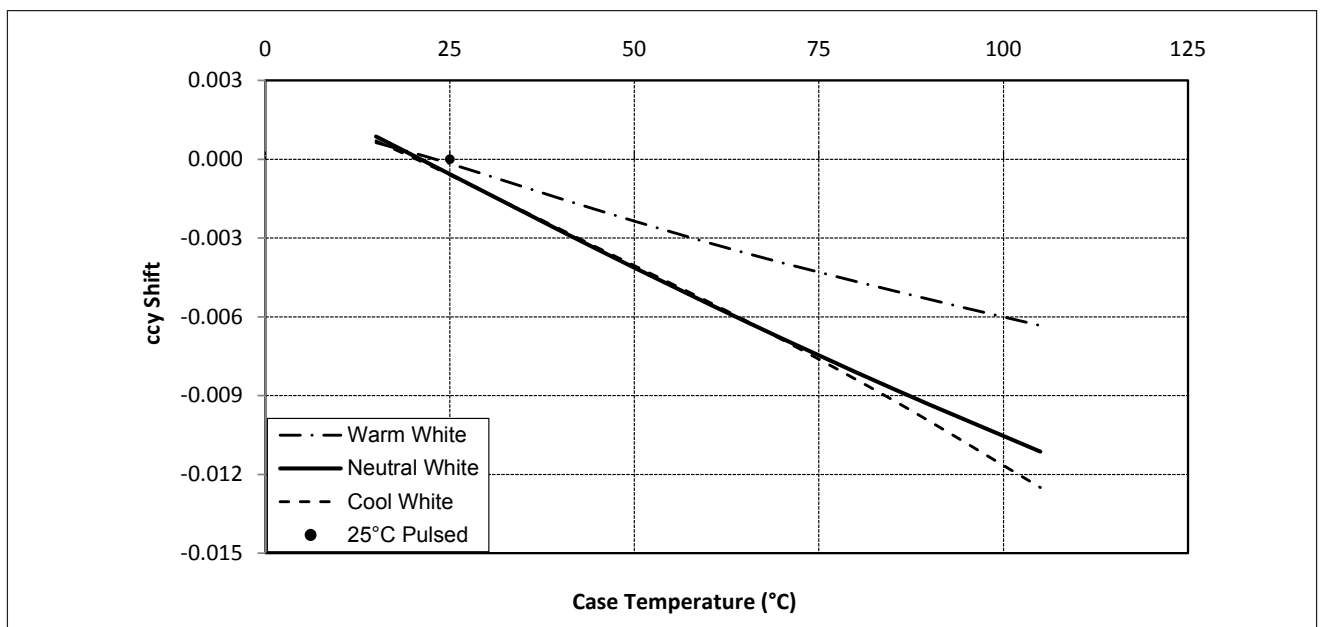

Figure 6: Typical DC ccy Shift vs. Case Temperature



Notes for Figures 5 & 6:

1. Characteristics shown for warm white based on 3000K and 80 CRI.
2. Characteristics shown for neutral white based on 4000K and 80 CRI.
3. Characteristics shown for cool white based on 5000K and 70 CRI.
4. For other color SKUs, the shift in color will vary. Please contact your Bridgelux sales representative for more information.

Performance Curves

Figure 7: Typical DC ccx Shift vs. Case Temperature

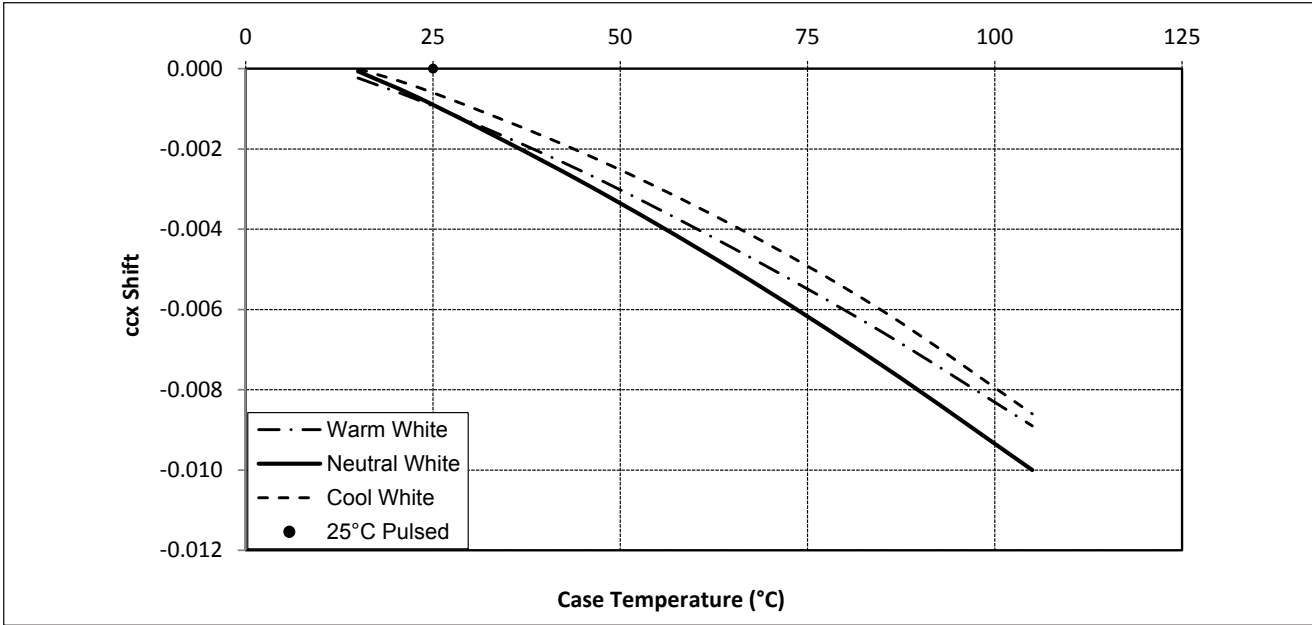

Notes for Figure 7:

1. Characteristics shown for warm white based on 3000K and 80 CRI.
2. Characteristics shown for neutral white based on 4000K and 80 CRI.
3. Characteristics shown for cool white based on 5000K and 70 CRI.
4. For other color SKUs, the shift in color will vary. Please contact your Bridgelux sales representative for more information.

Typical Radiation Pattern

Figure 8: Typical Spatial Radiation Pattern

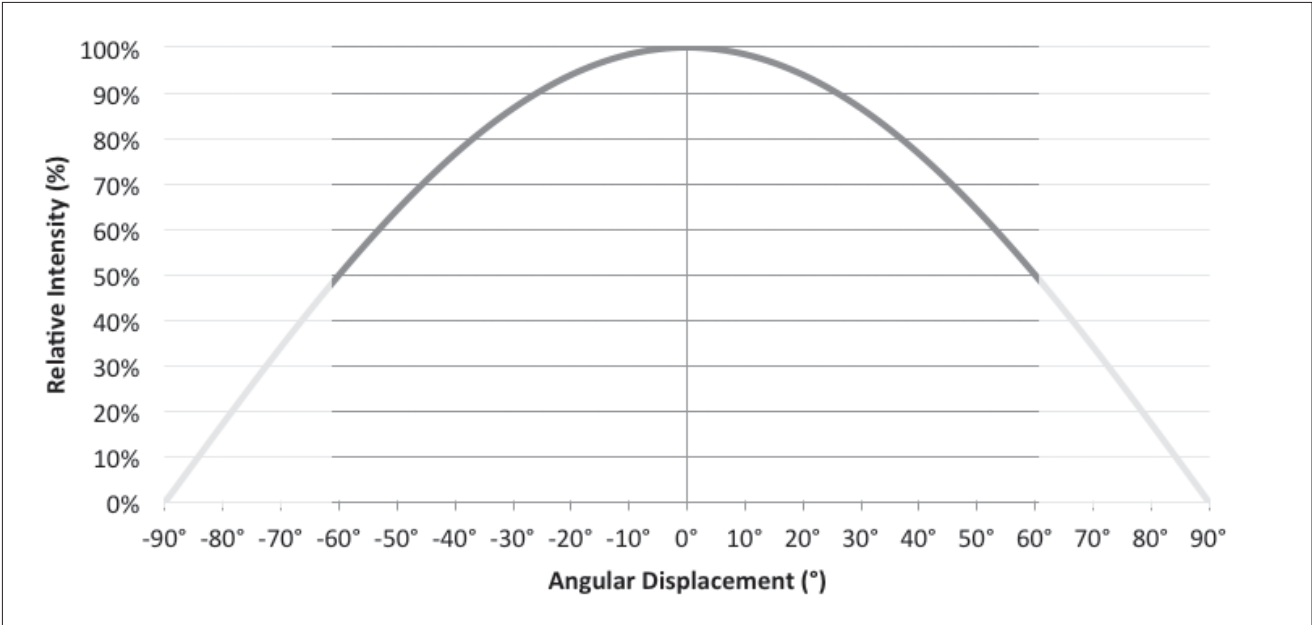

Notes for Figure 8:

- 1. Typical viewing angle is 120°.
- 2. The viewing angle is defined as the off axis angle from the centerline where intensity is 1/2 of the peak value.

Figure 9: Typical Polar Radiation Pattern

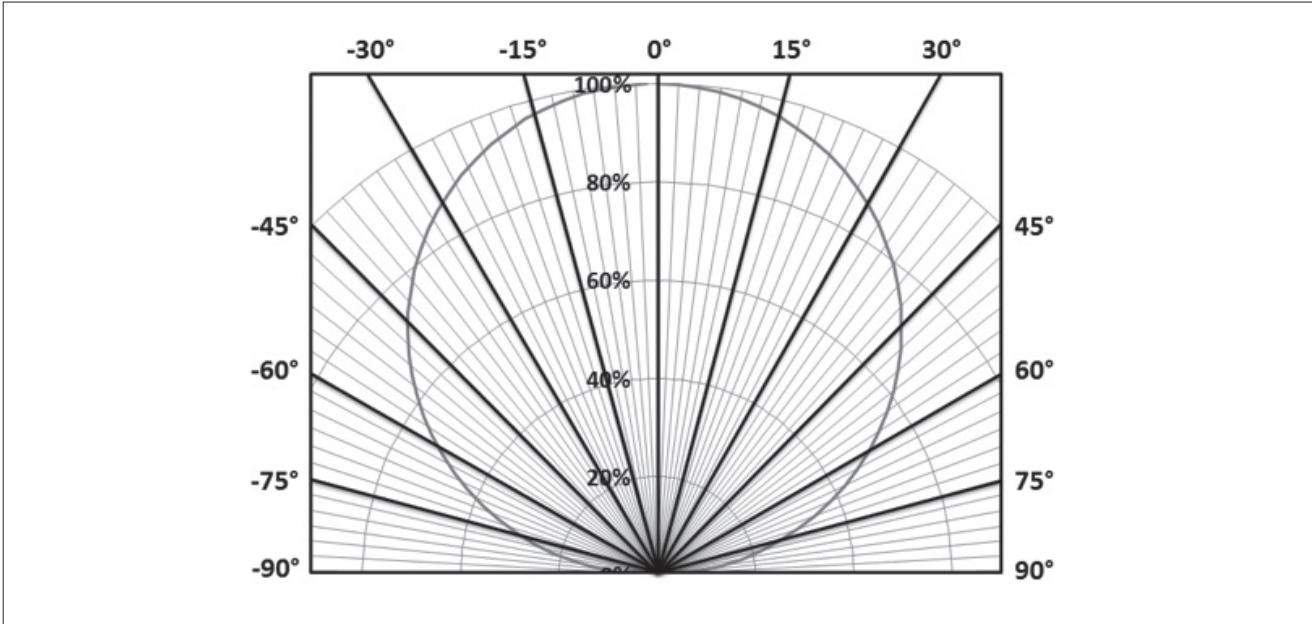

Typical Color Spectrum

Figure 10: Typical Color Spectrum

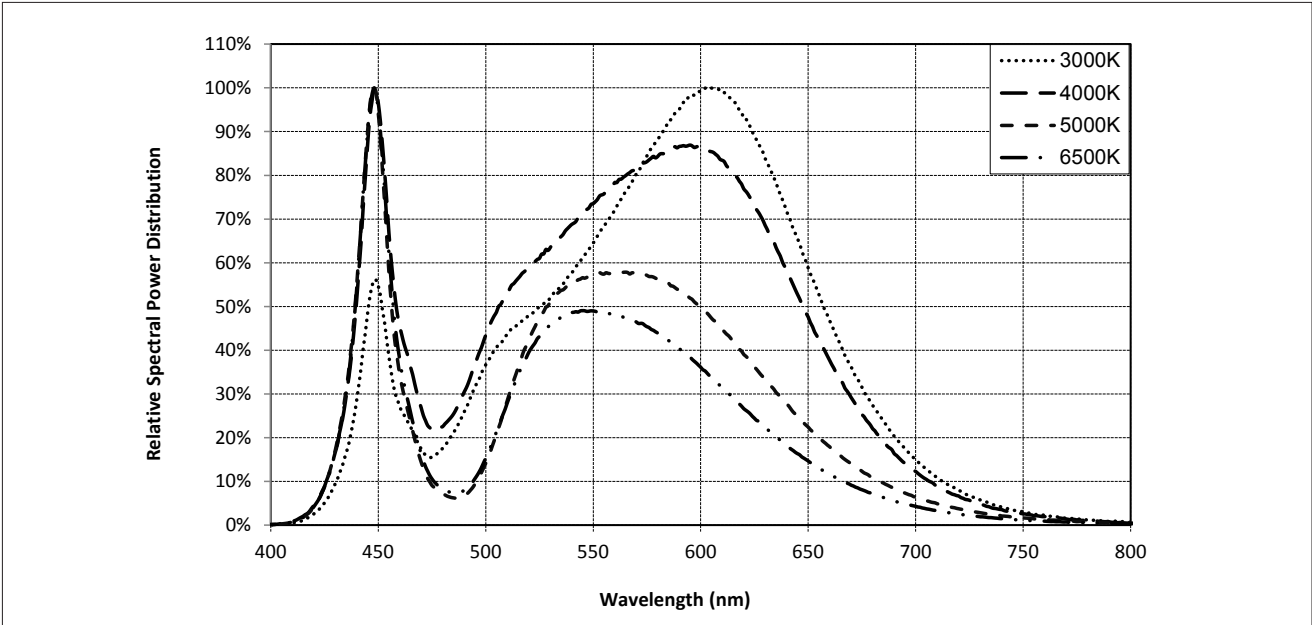

- Notes for Figure 10:
- 1. Color spectra measured at nominal current for $T_j = T_c = 25^\circ\text{C}$.
 - 2. Color spectra shown is 3000K and 80 CRI.
 - 3. Color spectra shown is 4000K and 80 CRI.
 - 4. Color spectra shown is 5000K and 70 CRI.
 - 4. Color spectra shown is 6500K and 70 CRI.

Mechanical Dimensions

Figure 11: V13 LED Array

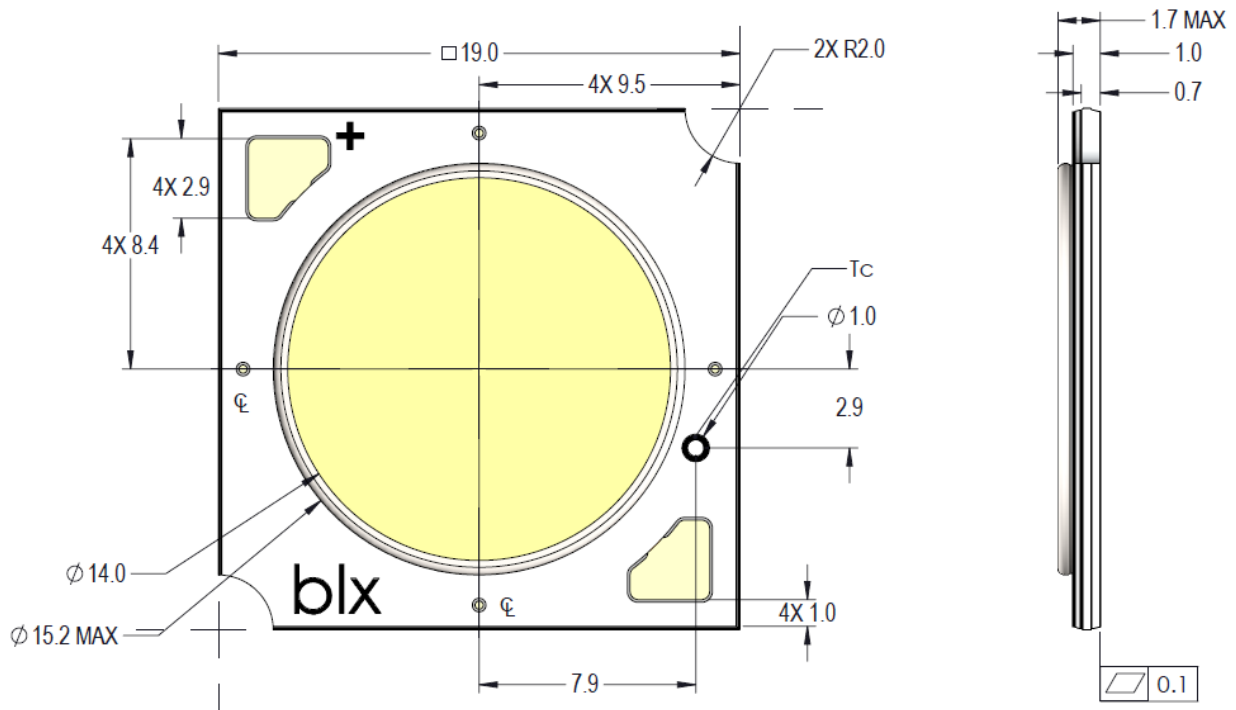

Notes for Figure 11:

1. Drawings are not to scale.
2. Drawing dimensions are in millimeters.
3. Unless otherwise specified, tolerances are $\pm 0.1\text{mm}$.
4. Mounting holes (2X) are for M2.5 screws.
5. Bridgelux recommends two tapped holes for mounting screws with $31.4 \pm 0.10\text{mm}$ center-to-center spacing.
6. Screws with flat shoulders (pan, dome, button, round, truss, mushroom) provide optimal torque control. Do NOT use flat, countersink, or raised head screws.
7. Solder pads and connector port are labeled "+" and "-" to denote positive and negative, respectively.
8. It is not necessary to provide electrical connections to both the solder pads and the connector port. Either set may be used depending on application specific design requirements.
9. Refer to Application Notes AN30 and AN31 for product handling, mounting and heat sink recommendations.
10. The optical center of the LED Array is nominally defined by the mechanical center of the array to a tolerance of $\pm 0.2\text{mm}$.
11. Bridgelux maintains a flatness of 0.10mm across the mounting surface of the array.

Color Binning Information

Figure 12: Graph of Warm and Neutral White Test Bins in xy Color Space

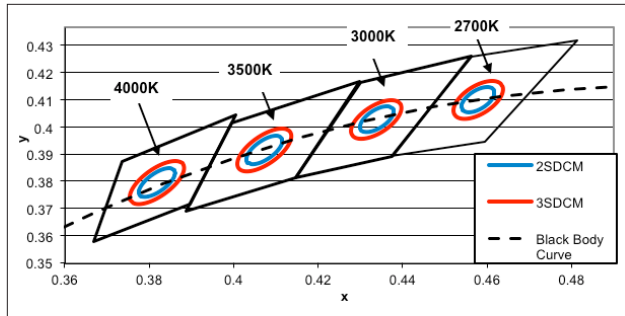

Note: Pulsed Test Conditions, $T_c = 25^\circ\text{C}$

Table 6: Warm and Neutral White xy Bin Coordinates and Associated Typical CCT

Bin Code	2700K	3000K	3500K	4000K
ANSI Bin (for reference only)	(2580K - 2870K)	(2870K - 3220K)	(3220K - 3710K)	(3710K - 4260K)
23 (3 SDCM)	(2651K - 2794K)	(2968K - 3136K)	(3369K - 3586K)	(3851K - 4130K)
22 (2 SDCM)	(2674K - 2769K)	(2995K - 3107K)	(3404K - 3548K)	(3895K - 4081K)
Center Point (x,y)	(0.4578, 0.4101)	(0.4338, 0.403)	(0.4073, 0.3917)	(0.3818, 0.3797)

Figure 13: Graph of Cool White Test Bins in xy Color Space

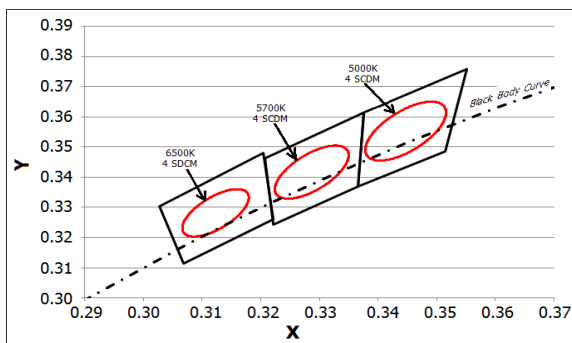

Note: Pulsed Test Conditions, $T_c = 25^\circ\text{C}$

Table 7: Cool White xy Bin Coordinates and Associated Typical CCT (product is hot targeted to $T_c = 85^\circ\text{C}$)

Bin Code	5000K	5700K	6500K
ANSI Bin (for reference only)	(4745K - 5311K)	(5312K - 6022K)	(6022K - 7042K)
4 (4 SDCM)	(4801K - 5282K)	(5829K - 5481K)	(6270K - 6765K)
Center Point (x,y)	(0.3447, 0.3553)	(0.3287, 0.3417)	(0.3123, 0.3282)

Packaging and Labeling

Figure 14: Drawing for V13 Packaging Tray

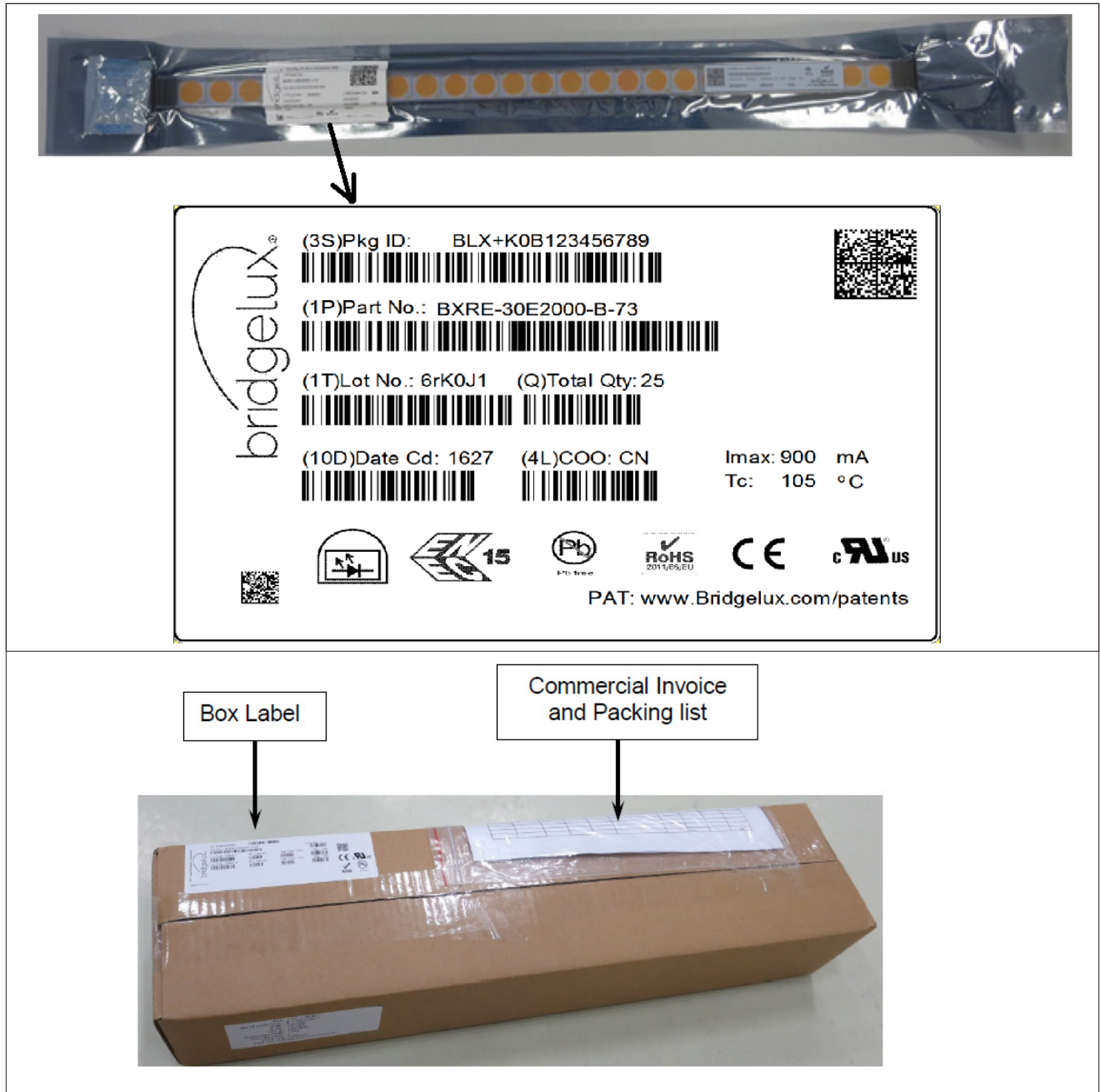

Notes for Figure 14:

1. Each tube holds 25 V13 COB arrays.
2. One tube is sealed in an anti-static bag. Four bags are placed in a shipping box. Depending on quantities ordered, a bigger shipping box, containing four boxes may be used to ship products.
3. Each bag and box is to be labeled as shown above.
4. Dimensions for each tube are 21.3 (W) x 9.5(H) x 505 (L). Dimensions for the anti-static bag are 75 (W) x 615 (L) x 3.1 (T) mm. Dimensions for the shipping box are 58.7 x 13.3 x 7.9 cm.

Packaging and Labeling

Figure 15: Gen. 7 Product Labeling

Bridgelux COB arrays have laser markings on the back side of the substrate to help with product identification. In addition to the product identification markings, Bridgelux COB arrays also contain markings for internal Bridgelux manufacturing use only. The image below shows which markings are for customer use and which ones are for Bridgelux internal use only. The Bridgelux internal manufacturing markings are subject to change without notice, however these will not impact the form, function or performance of the COB array.



Design Resources

Application Notes

Bridgelux has developed a comprehensive set of application notes and design resources to assist customers in successfully designing with the V Series product family of LED array products. For all available application notes visit www.bridgelux.com.

Optical Source Models

Optical source models and ray set files are available for all Bridgelux products. For a list of available formats, visit www.bridgelux.com.

3D CAD Models

Three dimensional CAD models depicting the product outline of all Bridgelux V Series LED arrays are available in both IGS and STEP formats. Please contact your Bridgelux sales representative for assistance.

LM80

LM80 testing is ongoing. Please contact your Bridgelux sales representative for more information.

Precautions

CAUTION: CHEMICAL EXPOSURE HAZARD

Exposure to some chemicals commonly used in luminaire manufacturing and assembly can cause damage to the LED array. Please consult Bridgelux Application Note AN31 for additional information.

CAUTION: EYE SAFETY

Eye safety classification for the use of Bridgelux V Series LED arrays is in accordance with specification IEC/TR 62778: Application of IEC 62471 for the assessment of blue light hazard to light sources and luminaires. V Series LED arrays are classified as Risk Group 2 (Moderate Risk) when operated at or below 2.5 times the nominal drive current. The Ethr value is 889.79 lux per IEC/TR 62778. Please use appropriate precautions. Under many operating conditions the V Series LED arrays are classified as Risk Group 1, for more information please contact your Bridgelux sales representative. It is important that employees working with LEDs are trained to use them safely.

CAUTION: RISK OF BURN

Do not touch the V Series LED array during operation. Allow the array to cool for a sufficient period of time before handling. The V Series LED array may reach elevated temperatures such that could burn skin when touched

CAUTION

CONTACT WITH LIGHT EMITTING SURFACE (LES)

Avoid any contact with the LES. Do not touch the LES of the LED array or apply stress to the LES (yellow phosphor resin area). Contact may cause damage to the LED array.

Optics and reflectors must not be mounted in contact with the LES (yellow phosphor resin area). Use the mechanical features of the LED array housing, edges and/or mounting holes to locate and secure optical devices as needed.

Disclaimers

MINOR PRODUCT CHANGE POLICY

The rigorous qualification testing on products offered by Bridgelux provides performance assurance. Slight cosmetic changes that do not affect form, fit, or function may occur as Bridgelux continues product optimization.

STANDARD TEST CONDITIONS

Unless otherwise stated, array testing is performed at the nominal drive current.

About Bridgelux: We Build Light That Transforms

At Bridgelux, we help companies, industries and people experience the power and possibility of light. Since 2002, we've designed LED solutions that are high performing, energy efficient, cost effective and easy to integrate. Our focus is on light's impact on human behavior, delivering products that create better environments, experiences and returns—both experiential and financial. And our patented technology drives new platforms for commercial and industrial luminaires.

For more information about the company, please visit

bridgelux.com

twitter.com/Bridgelux

facebook.com/Bridgelux

WeChat ID: BridgeluxInChina



101 Portola Avenue

Livermore, CA 94551

Tel (925) 583-8400

Fax (925) 583-8410

www.bridgelux.com

© 2016 Bridgelux, Inc. All rights reserved 2016. Product specifications are subject to change without notice. Bridgelux, the Bridgelux stylized logo design and Vero are registered trademarks, and Decor Series is a trademark of Bridgelux, Inc. All other trademarks are the property of their respective owners.

Bridgelux Gen 7 V13 Array Series Product Data Sheet DS101 Rev. A (06/2016)