

**PLEASE CHECK WWW.MOLEX.COM FOR LATEST PART INFORMATION**

**Part Number:** [0541323362](#)  
**Status:** **Active**  
**Overview:** FFC-FPC (SMT)  
**Description:** 0.50mm Pitch Easy-On™ Type FFC/FPC Connector, Right Angle, Surface Mount, ZIF, Bottom Contact Style, 33 Circuits, 0.1µm Gold (Au) Contact Plating

**Documents:**

[3D Model](#) [RoHS Certificate of Compliance \(PDF\)](#)  
[Drawing \(PDF\)](#)

**Agency Certification**

UL E29179

**General**

Product Family FFC/FPC Connectors  
 Series [54132](#)  
 Overview [FFC-FPC \(SMT\)](#)  
 Product Name Easy-On™  
 UPC 822350128421

**Physical**

Circuits (Loaded) 33  
 Color - Resin Black, Natural  
 Contact Position Bottom  
 Durability (mating cycles max) 20  
 Entry Angle 90° Angle  
 Flammability 94V-0  
 Mated Height 2.00mm  
 Material - Metal Phosphor Bronze  
 Material - Plating Mating Gold  
 Material - Plating Termination Gold  
 Material - Resin High Temperature Thermoplastic  
 Net Weight 383.047/mg  
 Number of Rows 1  
 Orientation Right Angle  
 PCB Locator No  
 PCB Retention Yes  
 Packaging Type Embossed Tape on Reel  
 Pitch - Mating Interface 0.50mm  
 Plating min - Mating 0.102µm  
 Plating min - Termination 0.051µm  
 Polarized to PCB Yes  
 Stackable No  
 Surface Mount Compatible (SMC) N/A  
 Temperature Range - Operating -40°C to +85°C  
 Termination Interface: Style Surface Mount  
 Wire/Cable Type FFC/FPC

**Electrical**

Current - Maximum per Contact 0.5A  
 Voltage - Maximum 50V

**Material Info**

**Reference - Drawing Numbers**

Sales Drawing SD-54132-064, SD-54132-065

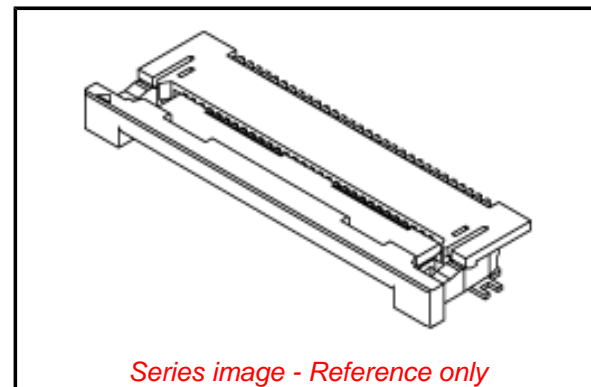

*Series image - Reference only*

**EU ELV**

**Not Relevant**

**EU RoHS**

**Compliant**

**REACH SVHC**

Not Contained Per -  
 ED/21/2016 (20 June  
 2016)

**Halogen-Free**

**Status**

**Not Low-Halogen**

**Need more information on product  
 environmental compliance?**

Email [productcompliance@molex.com](mailto:productcompliance@molex.com)  
 Please visit the [Contact Us](#) section for any  
 non-product compliance questions.

China ROHS

ELV

Green Image

Not Relevant

**Search Parts in this Series**

[54132 Series](#)

**Mates With**

<a href="http://www.molex.com/product/premoflex\_ffc-fpc.html">Molex Premo-Flex FFC</a>. Be sure to match like plating

This document was generated on 08/29/2016

**PLEASE CHECK [WWW.MOLEX.COM](http://WWW.MOLEX.COM) FOR LATEST PART INFORMATION**