

LANTRONIX®



**xDirect™**  
**User Guide**

Part Number 900-653-R  
Revision A September 2012

---

## Copyright & Trademark

© 2012 Lantronix, Inc. All rights reserved. No part of the contents of this book may be transmitted or reproduced in any form or by any means without the written permission of Lantronix.

Lantronix® is a registered trademark and xDirect™ and DeviceInstaller™ are trademarks of Lantronix, Inc.

Windows® and Internet Explorer® are registered trademarks of Microsoft Corporation. Mozilla® and Firefox® are registered trademarks of the Mozilla Foundation. Chrome™ is a trademark of Google. Tera Term® is a registered trademark of Vector, Inc. All other trademarks and trade names are the property of their respective holders.

## Warranty

For details on the Lantronix warranty policy, please go to our web site at [www.lantronix.com/support/warranty](http://www.lantronix.com/support/warranty).

## Contacts

### Lantronix, Inc.

167 Technology Drive  
Irvine, CA 92618, USA

Toll Free: 800-526-8766  
Phone: 949-453-3990  
Fax: 949-450-7249

### Technical Support

Online: [www.lantronix.com/support](http://www.lantronix.com/support)

### Sales Offices

For a current list of our domestic and international sales offices, go to the Lantronix web site at [www.lantronix.com/about/contact](http://www.lantronix.com/about/contact).

## Disclaimer

The information in this guide may change without notice. The manufacturer assumes no responsibility for any errors that may appear in this guide.

## Revision History

Date	Rev.	Comments
September 2012	A	Initial document for firmware version 6.9.0.0.

## Table of Contents

Copyright & Trademark _____	2
Warranty _____	2
Contacts _____	2
Disclaimer _____	2
Revision History _____	2
List of Figures _____	8
List of Tables _____	9
<b>1: Using this Guide</b> _____	<b>10</b>
Purpose and Audience _____	10
Chapter Summary _____	10
Additional Documentation _____	11
<b>2: Introduction</b> _____	<b>12</b>
Key Features _____	12
Applications _____	12
Protocol Support _____	14
Additional Features _____	14
Configuration Methods _____	14
Product Information Label _____	15
<b>3: Installation of xDirect</b> _____	<b>16</b>
Package Contents _____	16
Installing the xDirect _____	16
Required Information _____	17
Hardware Address _____	17
IP Address _____	17
<b>4: Using DeviceInstaller</b> _____	<b>18</b>
Installing DeviceInstaller _____	18
Assigning an IP Address _____	18
Adding the Unit to the Manage List _____	19
Accessing the xDirect Using DeviceInstaller _____	19
Viewing the Current Configuration _____	19
Next Step _____	21
Assigning the IP Address: Serial Port Login _____	21

---

<b>5: Configuration Using Web Manager</b>	<b>22</b>
Accessing xDirect Using DeviceInstaller _____	22
Network Configuration _____	24
Network <b>Mode</b> _____	24
Automatic IP Address Configuration _____	24
Static IP Address Configuration _____	25
Ethernet Configuration _____	25
Server Configuration _____	26
Server Configuration _____	26
Advanced _____	26
Host List Configuration _____	28
Retry Settings _____	28
Host Information _____	28
Channel 1 Configuration _____	29
Serial Settings _____	29
Channel 1 _____	29
Port Settings _____	29
Pack Control _____	30
Flush Input Buffer (Serial to Network) _____	30
Flush Output Buffer (Network to Serial) _____	30
Connection Settings - TCP _____	31
Connect Protocol _____	31
Connect Mode: Passive Connection _____	31
Connect Mode: Active Connection _____	32
Endpoint Configuration _____	32
Common Options _____	32
Disconnect Mode _____	33
Connection Settings - UDP _____	33
Connect Protocol _____	34
Datagram Mode _____	34
Endpoint Configuration _____	34
Apply Settings _____	35
Apply Defaults _____	35
<b>6: Configuration Via Telnet or Serial Port (Setup Mode)</b>	<b>36</b>
Accessing Setup Mode _____	36
Telnet Connection _____	36
Serial Port Connection _____	38
Exiting Setup Mode _____	38

---

<b>7: Setup Mode: Server Configuration</b>	<b>39</b>
Server Configuration (Option 0)	39
IP Address	39
Set Gateway IP Address	40
Netmask: Number of Bits for Host Part	40
Set DNS Server IP Address	40
Change Telnet Configuration Password	41
DHCP Name	41
<b>8: Setup Mode: Channel Configuration</b>	<b>42</b>
Channel 1 (Option 1)	42
Baudrate	42
I/F (Interface) Mode	43
Flow	43
Port Number	44
Connect Mode	44
a) Incoming Connection	45
b) Response	46
c) Active Startup	46
Host List Option (Hostlist)	47
d) Datagram Type	48
e) Modem Mode	48
Send the Escape Sequence (+++) in Modem Mode	50
Show IP Address after 'RING'	50
Auto Increment Source Port	51
Remote IP Address	51
Remote Port	51
Disconnect Mode (DisConnMode)	51
Flush Mode (Buffer Flushing)	52
Pack Control	53
Packing Interval	53
Trailing Characters	53
Send Characters	53
DisConnTime (Inactivity Timeout)	54
Send Characters	54
Telnet Terminal Type	54
Channel (Port) Password	54

---

<b>9: Setup Mode: Advanced Settings</b>	<b>55</b>
Expert Settings (Option 5)	55
TCP Keepalive Time In Seconds	55
ARP Cache Timeout In Seconds	55
CPU Performance	55
Monitor Mode at Bootup	56
HTTP Port Number	56
MTU Size	56
TCP Re-Transmission Timeout	56
Enable Alternate MAC	56
Ethernet Connection Type	56
Security Settings (Option 6)	56
Disable SNMP	57
SNMP Community Name	57
Disable Telnet Setup	57
Disable TFTP Firmware Update	58
Disable Port 77FE (Hex)	58
Disable Web Server	58
Disable Web Setup	58
Disable ECHO Ports	58
Enable Encryption	58
Enable Enhanced Password	59
Default Settings (Option 7)	59
Channel 1 Configuration Defaults	60
Expert Settings Defaults	60
Security Settings Defaults	60
<b>10: Firmware Upgrades</b>	<b>61</b>
Obtaining Firmware	61
Reloading Firmware	61
Using TFTP: Graphical User Interface	61
Using TFTP: Command Line Interface	62
Recovering the Firmware Using the Serial Port and DeviceInstaller	62
<b>11: Monitor Mode</b>	<b>64</b>
Entering Monitor Mode Using the Serial Port	64
Entering Monitor Mode Using the Network Port	64
Monitor Mode Commands	65

---

<b>Appendix A: Troubleshooting and Contact Info</b>	<b>67</b>
LEDs _____	67
Status LED _____	67
Serial LEDs _____	68
RJ45 Ethernet LED _____	68
Problems and Error Messages _____	68
Technical Support _____	71
<b>Appendix B: Connections and Pinouts</b>	<b>72</b>
Serial Port Pinouts _____	72
Ethernet Connector Pinouts _____	73
Power Jack (Mini USB-B) _____	74
<b>Appendix C: Technical Specifications</b>	<b>75</b>
<b>Appendix D: Alternative Ways to Assign an IP Address</b>	<b>77</b>
DHCP _____	77
AutoIP _____	77
BOOTP _____	78
ARP and Telnet _____	78
<b>Appendix E: Binary to Hexadecimal Conversions</b>	<b>79</b>
Converting Binary to Hexadecimal _____	79
Conversion Table _____	79
Scientific Calculator _____	79
<b>Appendix F: Compliance</b>	<b>81</b>

## List of Figures

Figure 2-1 Serial Tunneling Example	13
Figure 2-2 Direct TCP/IP or Redirector Configuration	13
Figure 2-3 Product Label	15
Figure 2-4 Sample Hardware Address	15
Figure 3-1 xDirect with PoE Connected to a Serial Device and Network	16
Figure 3-2 Standard xDirect (without PoE) Connected to a Serial Device and Network	16
Figure 5-1 Web Manager Login Window	22
Figure 5-2 Lantronix Web Manager	23
Figure 5-3 Network Settings	24
Figure 5-4 Server Settings	26
Figure 5-5 Hostlist Settings	28
Figure 5-6 Channel Serial Settings	29
Figure 5-7 TCP Connection Settings	31
Figure 5-8 UDP Connection Settings	34
Figure 5-9 Apply Settings and Apply Defaults	35
Figure 6-1 MAC Address and Login Prompt	36
Figure 6-2 Setup Menu Options	37
Figure 7-1 Network Settings	39
Figure 8-1 Serial Port Settings	42
Figure 8-8 Host List Option (Hostlist)	47
Figure 9-1 Expert Settings	55
Figure 9-2 Security Settings	57
Figure 10-2 TFTP Window	62
Figure 11-1 MAC Address and Login Prompt	64
Figure A-1 xDirect LEDs	67
Figure B-1 Single Serial Port and Ethernet Port on xDirect	72
Figure B-2 DB9F in RS232 Mode (All Models)	72
Figure B-3 DB9F in RS422/485 (4-Wire) Mode (xDirect485 & PoE Models)	72
Figure B-4 DB9F in RS485 (2-Wire) Mode (xDirect485 & PoE Models)	73
Figure B-5 RJ45 Ethernet Connector	73
Figure B-7 Mini USB Power Port Connector on Standard xDirect Units	74
Figure E-2 Windows Scientific Calculator	80
Figure E-3 Hexadecimal Values in the Scientific Calculator	80



## List of Tables

Table 4-1 xDirect Configuration in DeviceInstaller	19
Table 7-2 BootP/DHCP/AutoIP options	39
Table 7-3 Standard IP Network Netmasks	40
Table 8-2 Interface Mode Options	43
Table 8-3 Common Interface Mode Settings	43
Table 8-4 Flow Control Options	44
Table 8-5 Reserved Port Numbers	44
Table 8-6 Connect Mode Options	45
Table 8-7 Manual Connection Address Example	46
Table 8-9 Modem Mode Messages	49
Table 8-10 Modem Mode Commands	50
Table 8-11 Disconnect Mode Options	52
Table 8-12 Flush Mode Options	52
Table 8-13 Pack Control Options	53
Table 10-1 Firmware Files	61
Table 11-2 Monitor Mode Commands	65
Table 11-3 Command Response Codes	66
Table A-2 Status LED	67
Table A-3 Serial LEDs	68
Table A-4 Ethernet Link LED	68
Table A-5 Ethernet Activity LED	68
Table A-6 Problems and Error Messages	68
Table B-6 Ethernet RJ45 Connector Pin-Outs	73
Table C-1 xDirect Technical Specifications	75
Table E-1 Binary to Hexadecimal Conversion	79

# 1: Using this Guide

## Purpose and Audience

This guide provides the information needed to configure, use, and update the xDirect device server. It is for system administrators and those responsible for installing and maintaining the xDirect.

## Chapter Summary

The remaining chapters in this guide include:

Chapter	Description
<a href="#">Chapter 2: Introduction</a>	Describes the main features of the xDirect and the protocols it supports.
<a href="#">Chapter 3: Installation of xDirect</a>	Provides information for installing your unit and getting it up and running using DeviceInstaller or a serial port connection.
<a href="#">Chapter 4: Using DeviceInstaller</a>	Instructions for viewing the current configuration using DeviceInstaller.
<a href="#">Chapter 5: Configuration Using Web Manager</a>	Details using the Web Manager to set parameters such as port and server properties.
<a href="#">Chapter 6: Configuration Via Telnet or Serial Port (Setup Mode)</a>	Provides instructions for accessing Setup Mode (command line interface) using a Telnet connection through the network or a terminal or terminal emulation program through the serial port.
<a href="#">Chapter 7: Setup Mode: Server Configuration</a>	Details the network (server) settings
<a href="#">Chapter 8: Setup Mode: Channel Configuration</a>	Details the serial port settings.
<a href="#">Chapter 9: Setup Mode: Advanced Settings</a>	Details expert and security settings and explains how to reset the unit to factory default values.
<a href="#">Chapter 10: Firmware Upgrades</a>	Provides instructions for obtaining the latest firmware and updating the xDirect.
<a href="#">Chapter 11: Monitor Mode</a>	Provides instructions for accessing and using the command line interface to monitor the network and diagnose problems.
<a href="#">Appendix A: Troubleshooting and Contact Info</a>	Describes common problems and error messages and how to contact Lantronix Technical Support.
<a href="#">Appendix B: Connections and Pinouts</a>	Provides descriptions and illustrations of connection hardware.
<a href="#">Appendix C: Technical Specifications</a>	Lists technical specifications for the xDirect.
<a href="#">Appendix D: Alternative Ways to Assign an IP Address</a>	Provides detailed information about using DHCP, AutoIP, BOOTP, ARP, and Telnet to assign an IP address.
<a href="#">Appendix E: Binary to Hexadecimal Conversions</a>	Provides instructions for converting binary values to hexadecimals.
<a href="#">Appendix F: Compliance</a>	Provides Lantronix compliance information.

---

## Additional Documentation

Visit the Lantronix Web site at [www.lantronix.com/support/documentation](http://www.lantronix.com/support/documentation) for the latest documentation and the following additional documentation.

<b>Document</b>	<b>Description</b>
<b><i>xDirect Quick Start</i></b>	Provides the steps for getting the xDirect up and running.
<b><i>DeviceInstaller Online Help</i></b>	Provides instructions for using the Windows-based utility to configure the xDirect and other Lantronix device servers.
<b><i>“Live” Tutorials on the Lantronix Web Site (English)</i></b>	Explain and demonstrate assigning an IP address to the xDirect and setting up the xDirect and Com Port Redirector. See <a href="http://ltxfaq.custhelp.com/app/answers/detail/a_id/1119">http://ltxfaq.custhelp.com/app/answers/detail/a_id/1119</a> .
<b><i>Com Port Redirector User Guide</i></b>	Provides information on using the Windows-based utility to create a virtual com port.

## 2: Introduction

xDirect is a sleek and compact Serial-to-Ethernet device server, providing quick and easy Ethernet connectivity to virtually any device or machine with a serial interface. With an integrated Ethernet port and serial cable, multiple power options including PoE, and an industry-best five year warranty, xDirect provides a portable, extremely flexible, and highly affordable network connectivity solution in the market. xDirect comes with a built-in web server that enables users to access and configure the unit using a standard web browser on a PC, smartphone, or tablet from anywhere. With plug-and-play simplicity, small form factor, multiple power options, and a robust device server application, xDirect provides the easiest and shortest path to network connectivity 'right on the wire'.

### Key Features

- ◆ Complete Network Connectivity Solution
- ◆ Integrated 10/100 Ethernet Port and Serial Cable
- ◆ Complete Device Server Application with Full IP Stack and Web Server
- ◆ Space Saving Form Factor
- ◆ Serial Data Rate of up to 921 Kbps<sup>1</sup>
- ◆ 128/192/256-bit AES Encryption
- ◆ Flexible Power Options: 5 VDC USB Jack, 5-15 VDC DB9 Pin 9, and PoE<sup>2</sup>
- ◆ Extended Temperature Range of -40° to 85°C<sup>3</sup>
- ◆ 5-year Limited Warranty
- ◆ Short cable
- ◆ 256-bit AES Encryption
- ◆ Password Protection

### Applications

The xDirect family of Device Servers allows serial devices, such as those listed below, to connect and communicate over Ethernet networks using the IP protocol family (TCP for connection-oriented stream applications and UDP for datagram applications).

- ◆ ATM Machines
- ◆ CNC Controllers
- ◆ Data Collection Devices
- ◆ Automation Control
- ◆ Data Display Devices/Digital Signage

---

1. When high performance mode in server settings is enabled.

2. PoE model only.

3. Non-PoE models only (UL certified -40° to +75°C).

- ◆ HVAC Systems
- ◆ Medical Devices
- ◆ Oil and Gas Exploration
- ◆ Security Alarms and Access Control Devices
- ◆ Telecommunications Equipment
- ◆ Time/Attendance Clocks and Terminals
- ◆ Universal Power Supply (UPS) Management Units

Using a method called serial tunneling, the xDirect encapsulates serial data into packets and transports them over Ethernet. Using two xDirect units, connected by a network, virtual serial connections can extend across a facility or around the world.

**Figure 2-1 Serial Tunneling Example**

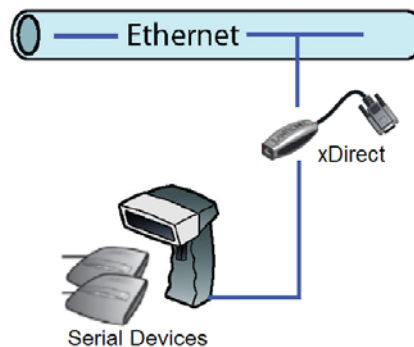

The Com Port Redirector software available for download at [www.lantronix.com/support/downloads](http://www.lantronix.com/support/downloads) simplifies the integration process by extending the functionality of COM-port-based Windows™ applications. Virtual COM ports, mapped to remote device servers on the network, can replace direct serial connections.

**Figure 2-2 Direct TCP/IP or Redirector Configuration**

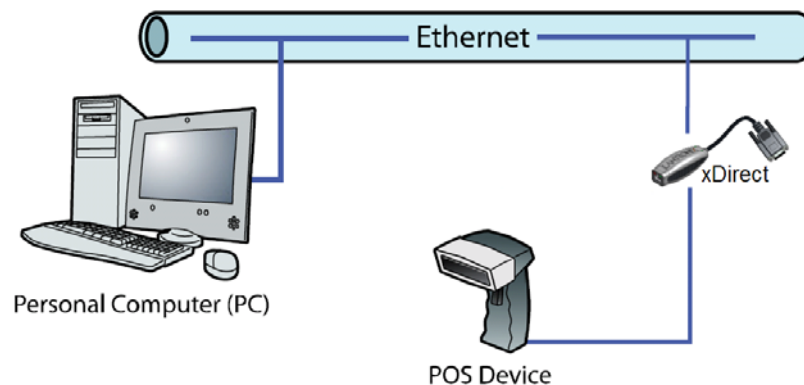

**Note:** For step-by-step instructions on configuring the xDirect for serial tunneling or for use with the Com Port Redirector, see xDirect Configuration Tutorials on the Lantronix web site: [www.lantronix.com/support](http://www.lantronix.com/support).

## Protocol Support

The xDirect uses the Internet Protocol (IP) for network communications and the Transmission Control Protocol (TCP) to assure that no data is lost or duplicated and that everything sent to the connection arrives correctly at the target.

Supported protocols include:

- ◆ ARP, UDP/IP, TCP/IP, BOOTP, ICMP, Telnet, TFTP, AutoIP, DHCP, HTTP, and SNMP for network communications.
- ◆ TCP/IP, UDP/IP, and Telnet for connections to the serial port as well as Telnet Com Port Control.
- ◆ TFTP for firmware updates.
- ◆ IP for addressing, routing, and data block handling over the network.
- ◆ User Datagram Protocol (UDP) for typical datagram applications in which devices interact with other devices without a point-to-point connection.

## Additional Features

**Modem Emulation:** In modem emulation mode, the xDirect can replace dial-up modems. The unit accepts modem AT commands on the serial port and then establishes a network connection to the end device. This arrangement leverages network connections and bandwidth to eliminate dedicated modems and phone lines.

**Built-in Web Server:** The xDirect includes a built-in web server for configuring the unit and displaying operating and troubleshooting information on the attached links to online support.

**Security Features:** Password Protection and 256-bit AES Encryption

## Configuration Methods

After installation, the xDirect requires configuration. For the unit to operate correctly on a network, it must have a unique IP address on the network. There are three basic methods for logging into the xDirect and assigning IP addresses and other configurable settings:

- ◆ **Web Manager:** View and configure all settings easily through a web browser using the Lantronix Web Manager. See [Chapter 5: Configuration Using Web Manager](#).
- ◆ **DeviceInstaller:** Configure the IP address and related settings and view current settings on the xDirect using a Graphical User Interface (GUI) on a PC attached to a network. You will need the latest version of DeviceInstaller. See [Chapter 4: Using DeviceInstaller](#).
- ◆ **Serial and Telnet Ports:** Use Setup Mode, a command line interface. There are two approaches to accessing Setup Mode: making a Telnet connection to the network port (9999) or connecting a terminal (or a PC running a terminal emulation program) to the unit's serial port. See [Chapter 6: Configuration Via Telnet or Serial Port \(Setup Mode\)](#).

## Product Information Label

The product information label on the unit contains the following information about the specific unit:

- ◆ Part Number
- ◆ Revision
- ◆ Manufacturing Date Code
- ◆ Product Model
- ◆ Country of Origin
- ◆ Lantronix Datamatrix Barcode
- ◆ MAC Address (also used as Serial Number)

**Note:** The hardware address on the label is also the product serial number. The hardware address on the label is the address for the Ethernet (eth0) interface.

Figure 2-3 Product Label

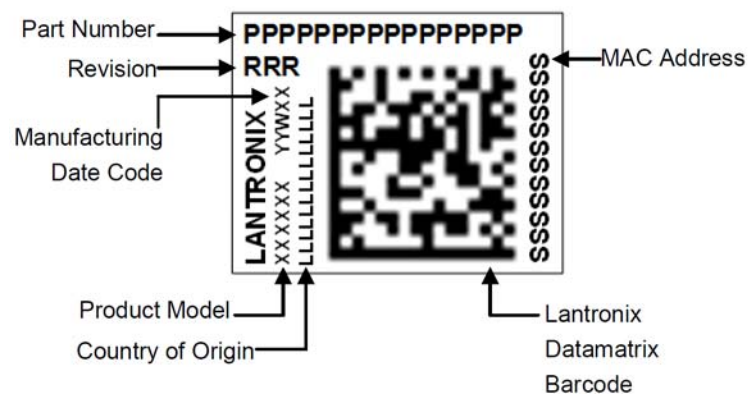

The first three bytes of the hardware address are fixed and identify the unit as a Lantronix product. The fourth, fifth, and sixth bytes are unique numbers assigned to each unit.

Figure 2-4 Sample Hardware Address

00-80-A3-14-01-18 or 00:80:A3:14:01:18

## 3: Installation of xDirect

This chapter describes how to install your xDirect and get it up and running in the shortest possible time.

### Package Contents

Verify and inspect the contents of the xDirect package using the following list. If any item is missing or damaged, contact your place of purchase immediately.

- ◆ xDirect
- ◆ Power supply\*

**Note:** \*Power supply available for non-Power Over Ethernet (PoE) units only.

- ◆ Quick Start Guide

### Installing the xDirect

Figure 3-1 xDirect with PoE Connected to a Serial Device and Network



Figure 3-2 Standard xDirect (without PoE) Connected to a Serial Device and Network

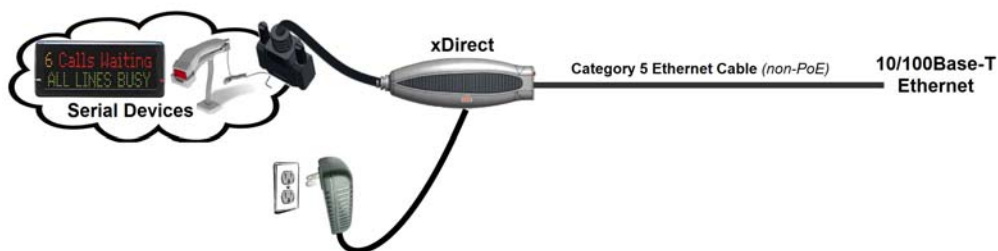

To install the unit:

**Note:** See the [Connections and Pinouts](#) for details about connectors and pinouts.

1. Connect a serial device to your xDirect.
2. Connect an Ethernet cable to the RJ45 port.
3. For the xDirect PoE version, power is supplied to your unit over the Ethernet interface using an 802.3af PoE-compliant power source such as a PoE mid-span or PoE Ethernet switch.

**Note:** xDirect is a PoE Power Device, Class 1. For indoor use only. Do not connect to PoE networks with cable routing to the outside plant!



- For non-PoE xDirect unit, supply power to your unit using the power supply that was included in the packaging.

**Note:** The provided power supply is 5 VDC 1A. For all xDirect units power can also be supplied via pin 9 (+) and pin 5 (-) on the DB9F connector (voltage range = 5 VDC to 15 VDC). The xDirect will draw 1.3W max power.

## Required Information

Before configuring the xDirect, have the following information available:

### Hardware Address

Take note of the unit's hardware address (also known as the Ethernet or MAC address). It is on the product label, in the format: 00-80-A3-XX-XX-XX, where the XXs are unique numbers assigned to the product (see [Product Information Label](#)).

Hardware Address: \_\_\_\_\_ - \_\_\_\_\_ - \_\_\_\_\_ - \_\_\_\_\_ - \_\_\_\_\_ - \_\_\_\_\_

### IP Address

The xDirect must have a unique IP address on your network. This address references the specific unit. By default, the unit is DHCP-enabled and automatically assigned an IP address on DHCP-enabled networks. If you are assigning a static IP address, the systems administrator generally provides the IP address, subnet mask, and gateway.

**Note:** The factory default IP address is 0.0.0.0 to enable DHCP, BOOTP, and AutoIP. When the units boots, it sends a DHCP broadcast to try and get an IP address. If it receives no reply from a DHCP server, the xDirect tries BOOTP. If the xDirect does not receive a response from BOOTP, it reverts to an AutoIP address.

IP Address: \_\_\_\_\_ . \_\_\_\_\_ . \_\_\_\_\_ . \_\_\_\_\_

Subnet Mask: \_\_\_\_\_ . \_\_\_\_\_ . \_\_\_\_\_ . \_\_\_\_\_

Gateway: \_\_\_\_\_ . \_\_\_\_\_ . \_\_\_\_\_ . \_\_\_\_\_

You have several options for assigning an IP address and related network settings to your unit. This chapter provides information about using the DeviceInstaller (graphical user interface) and serial port login (command line interface) methods.

**Note:** For information about other methods of assigning the IP address, such as DHCP, AutoIP, ARP, and Telnet, see [Appendix D: Alternative Ways to Assign an IP Address](#).

## 4: Using DeviceInstaller

This chapter covers the steps for getting the xDirect device server online and for viewing its current configuration.

**Note:** *DeviceInstaller* is a free utility program provided by Lantronix that discovers, configures, upgrades, and manages Lantronix Device Servers. It can be downloaded from the Lantronix website at [www.lantronix.com/support/downloads](http://www.lantronix.com/support/downloads).

For instructions on using *DeviceInstaller* to configure the IP address and related settings or for more advanced features, see the *DeviceInstaller Online Help*.

### Installing DeviceInstaller

**To install DeviceInstaller:**

1. Download the latest version of DeviceInstaller from <http://www.lantronix.com/support/downloads>.
2. Run the executable to start the installation process.
3. Respond to the installation wizard prompts. (If prompted to select an installation type, select Typical).

### Assigning an IP Address

The unit's IP address must be configured before it can work correctly on a network. The unit's IP address is normally set to 0.0.0.0 at the factory. The hardware address is on the product label. The unit is DHCP enabled as the default.

**To assign an IP address manually:**

1. Click **Start**→**Programs** → **Lantronix**→**DeviceInstaller**→**DeviceInstaller**. If your PC has more than one network adapter, a message displays. Select an adapter and click **OK**.  
**Note:** *If the unit already has an IP address (e.g., DHCP has assigned an IP address), click the **Search** icon and select the unit from the list of Lantronix device servers on the local network.*
2. Click the **Assign IP** icon.
3. If prompted, enter the hardware address (on the product label) and click **Next**.
4. Select **Assign a specific IP address** and click **Next**.
5. Enter the **IP address**. The **Subnet mask** displays automatically based on the IP address; if desired, you may change it. On a local network, you can leave the **Default gateway** blank (all zeros). Click **Next**.
6. Click the **Assign** button and wait several seconds until a confirmation message displays. Click **Finish**.
7. Select the device from the main window list and select **Ping** from the **Tools** menu. The Ping Device dialog box shows the IP address of the selected unit.
8. From the **Tools** menu, click the **Ping** button. The results display in the Status window. Click

the **Clear Status** button to clear the window so you can ping the device again.

**Note:** If you do not receive “Reply” messages, make sure the unit is attached to the network properly and the IP address assigned is valid for the particular network segment you are working with. If you are not sure, check with your systems administrator.

9. Click the **Close** button to close the dialog box and return to the main window.

## Adding the Unit to the Manage List

Now add the unit to the list of similar Lantronix devices on the network so you can manage and configure it. To perform this step, click the **Search** icon.

DeviceInstaller locates the unit and adds it to the list. Now you can manage (configure) the unit so it works with the serial device on the network.

## Accessing the xDirect Using DeviceInstaller

1. Click **Start**→**Programs** → **Lantronix**→**DeviceInstaller**→**DeviceInstaller**.
2. Click the xDirect folder. The list of available Lantronix xDirect devices displays.
3. Expand the list of xDirects by clicking the **+** symbol next to the xDirect icon. Select the xDirect unit by clicking on its IP address to view its configuration.

## Viewing the Current Configuration

DeviceInstaller provides a view of the unit's configuration.

**To view the unit's current settings:**

1. Follow the instructions above to locate the xDirect.
2. In the right pane, click the **Device Details** tab. The current xDirect configuration displays.

**Table 4-1 xDirect Configuration in DeviceInstaller**

Current Settings	Description
<b>Name</b>	Configurable field. A name that identifies the xDirect. The name field is blank by default. Double-click the field, type in the value, and press <b>Enter</b> to complete. This name is not visible on other PCs or laptops using DeviceInstaller.
<b>DHCP Device Name</b>	Non-configurable field. Displays the name associated with xDirect's current IP address, if the IP address was obtained dynamically. To change the DHCP device name, see <a href="#">Chapter 5: Configuration Using Web Manager</a> or <a href="#">Chapter 6: Configuration Via Telnet or Serial Port (Setup Mode)</a> .
<b>Group</b>	Configurable field. A group name to categorize the xDirect. Double-click the field, type in the value, and press <b>Enter</b> to complete. This group name is not visible on other PCs or laptops using DeviceInstaller.

Current Settings (continued)	Description
<b>Comments</b>	Configurable field. Information about the xDirect. Double-click the field, type in the value, and press <b>Enter</b> to complete. This description or comment is not visible on other PCs or laptops using DeviceInstaller.
<b>Device Family</b>	Non-configurable field. Displays the xDirect's device family as xDirect.
<b>Type</b>	Non-configurable field. Displays the device type as XDT232 or XDT485.
<b>ID</b>	Non-configurable field. Displays the xDirect's ID embedded within the unit.
<b>Hardware Address</b>	Non-configurable field. Displays the xDirect's hardware (or MAC) address.
<b>Firmware Version</b>	Non-configurable field. Displays the firmware currently installed on the xDirect.
<b>Extended Firmware Version</b>	Non-configurable field. Displays the full version nomenclature of the firmware.
<b>Online Status</b>	Non-configurable field. Displays the xDirect's status as online, offline, unreachable (the xDirect is on a different subnet), or busy (the xDirect is currently performing a task).
<b>IP Address</b>	Non-configurable field. Displays the xDirect's current IP address. To change the IP address, see <a href="#">Assigning an IP Address</a> .
<b>IP Address was Obtained</b>	Non-configurable field. Displays "Dynamically" if the xDirect automatically received an IP address (e.g., from DHCP). Displays "Statistically" if the IP address was configured manually. If the IP address was assigned dynamically, the following fields appear: <ul style="list-style-type: none"> <li>◆ Obtain with DHCP with value of True or False</li> <li>◆ Obtain with BOOTP with value of True or False</li> <li>◆ Obtain with RARP with value of True or False</li> <li>◆ Obtain with Auto IP with value of True or False</li> </ul>
<b>Subnet Mask</b>	Non-configurable field. Displays the xDirect's current subnet mask. To change the subnet mask, see <a href="#">Assigning an IP Address</a> .
<b>Gateway</b>	Non-configurable field. Displays the xDirect's current gateway. To change the gateway, see <a href="#">Assigning an IP Address</a> .
<b>Number of COB partitions supported</b>	Non-configurable field. Displays the number of COB partitions supported.
<b>Number of Ports</b>	Non-configurable field. Displays the number of ports on the xDirect.
<b>TCP Keepalive</b>	Non-configurable field. Displays the xDirect's TCP keepalive value. The value is in the range <b>1-65s</b> , and the default setting is <b>45</b> .
<b>Telnet Supported</b>	Non-configurable field. Indicates if Telnet sessions are permitted. Displays <b>True</b> .
<b>Telnet Port</b>	Non-configurable field. Displays the xDirect's port for telnet sessions.
<b>Web Port</b>	Non-configurable field. Displays the xDirect's port for Web Manager configuration.
<b>Maximum Baud Rate Supported</b>	Non-configurable field. Displays the xDirect's maximum baud rate. <b>Note:</b> The xDirect may not currently be running at this rate.
<b>Firmware Upgradable</b>	Non-configurable field. Displays <b>True</b> , indicating the xDirect's firmware is upgradable as newer version become available.
<b>Supports Configurable Pins</b>	Non-configurable field. Displays <b>False</b> .
<b>Supports Email Triggers</b>	Non-configurable field. Displays <b>False</b> .
<b>Supports AES Data Stream</b>	Non-configurable field. Displays <b>True</b> . xDirect supports AES encryption

Current Settings (continued)	Description
<b>Supports 485</b>	Non-configurable field. xDirect supports the RS-485 protocol. Displays: <ul style="list-style-type: none"> <li>◆ <b>False</b> for XDT232.</li> <li>◆ <b>True</b> for XDT485.</li> </ul>
<b>Supports 921K Baud Rate</b>	Non-configurable field. Displays <b>True</b> . xDirect supports baud rates up to 921600 bits per second (bps).
<b>Supports HTTP Server</b>	Non-configurable field. Displays <b>True</b> .
<b>Supports HTTP Setup</b>	Non-configurable field. Displays <b>True</b> .
<b>Supports 230K Baud Rate</b>	Non-configurable field. Displays <b>True</b> . xDirect supports a baud rate of 230400.
<b>Supports GPIO</b>	Non-configurable field. Displays <b>False</b> , indicating the xDirect does not support General Purpose Input Output (GPIO).

### Next Step

Now that the xDirect unit has an IP address and other initial settings, you can configure it.

1. Double-click the unit in the list. Details about the unit display.
2. You have the following options:
  - ◆ To configure the unit using a Web browser, click the Web Configuration tab. The Lantronix Web Manager window displays in your browser. Continue with [Chapter 5: Configuration Using Web Manager](#).

**Note:** To assign Expert and Security settings, you must use the Setup Mode window in a Telnet session.

  - ◆ To configure the unit using a Telnet session, click the Telnet Configuration tab. The Setup Mode window displays. Continue with [Chapter 6: Configuration Via Telnet or Serial Port \(Setup Mode\)](#).

## Assigning the IP Address: Serial Port Login

**To assign the IP address and other network settings using a serial connection:**

1. Connect a console terminal or a PC running a terminal emulation program to the unit's serial port. The default serial port settings are **9600 baud, 8 bits, no parity, 1 stop bit, no flow control**.
2. To enter Setup Mode, cycle the unit's power (power off and back on). After power-up, the self-test begins and the red Diagnostic LED starts blinking. **You have one second** to enter three lowercase **x** characters.

**Note:** The easiest way to enter Setup Mode is to hold down the **x** key at the terminal (or emulation) while powering up the unit.
3. Select **0** (Server Configuration) and follow the prompts until you get to **IP address**.
4. Enter the new IP address, subnet mask, and gateway (if applicable).
5. Do one of the following:
  - ◆ Continue with [Chapter 6: Configuration Via Telnet or Serial Port \(Setup Mode\)](#).
  - ◆ Select **9** to save and exit Setup Mode. The unit performs a power reset.

## 5: Configuration Using Web Manager

You must configure the unit so it can communicate on a network with your serial device. For example, you must set the way the unit will respond to serial and network traffic, how it will handle serial packets, and when to start or close a connection.

The unit's configuration is stored in nonvolatile memory and is retained without power. You can change the configuration at any time. The unit performs a reset after you change and store the configuration.

In this chapter, we describe how to configure the xDirect using Web Manager, Lantronix's browser-based configuration tool. (For information on using Setup Mode, our command line configuration interface, see [Chapter 6: Configuration Via Telnet or Serial Port \(Setup Mode\)](#).)

**Note:** The examples in this section show a typical device. Your device may have different configuration options.

### Accessing xDirect Using DeviceInstaller

**Note:** For more information on DeviceInstaller, see [Chapter 4: Using DeviceInstaller](#).

1. Run DeviceInstaller and search for the list of available Lantronix device servers.
2. Click on the **xDirect** folder. The list of available xDirect products display.
3. Expand the list of xDirect units by clicking the **+** symbol next to the xDirect icon.
4. Select the xDirect unit by clicking its hardware address.
5. In the right pane, click the **Web Configuration** tab.
6. To view the xDirect's Web Manager in the current DeviceInstaller window, click the **Go** button. To open the Web Manager in a web browser, click the **External Browser** button.

**Note:** Alternatively, to open Web Manager, open your web browser and enter the IP address of the xDirect.

A dialog box appears to prompt for a User Name and Password.

Figure 5-1 Web Manager Login Window

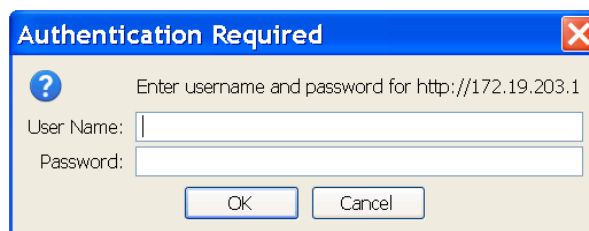

7. Enter your user name and password. The factory-default user name is "admin" and the password is "PASS". The Device Status page of Web Manager displays.

Figure 5-2 Lantronix Web Manager

The screenshot shows the Lantronix xDirect Web Manager interface. The left navigation pane includes links for Home, Network, Server, Serial Tunnel (with sub-links for Hostlist and Channel 1), Channel 1 (with sub-links for Serial Settings and Connection), Apply Settings, and Apply Defaults. The main content area is titled "Device Status" and displays the following configuration details:

Product Information	
Firmware Version:	V6.9.0.0
Build Date:	06-Sep-2012
Network Settings	
MAC Address:	00-20-4A-9D-02-8B
Network Mode:	Wired
DHCP HostName:	< None >
IP Address:	172.19.100.39
Default Gateway:	172.19.0.1
DNS Server:	172.19.1.1
MTU:	1400
Line settings	
Line 1:	RS232, 9600, 8, None, 1, None.

At the bottom of the interface, the footer text reads: "WebManager Version: 2.0.0.0" on the left and "Copyright © Lantronix, Inc. 2007-2012. All rights reserved." on the right.

8. Navigate between pages by clicking links in the left pane of the Web Manager window.

## Network Configuration

The unit's network values display when you select **Network** from the main menu. The following sections describe the configurable parameters on the Network Settings page.

Figure 5-3 Network Settings

### Network Mode

1. Click **Network** from the main menu.
2. Note the following:

<b>Network Mode</b>	For the xDirect, Wired Only is the only choice. It enables the Ethernet network connectivity.
---------------------	---

### Automatic IP Address Configuration

An IP address can be assigned automatically. You then enter related network settings.

#### To assign an IP address automatically:

1. On the main menu, click **Network**.
2. Select **Obtain IP address automatically**.
3. Enter the following (as necessary):

<b>BOOTP</b>	Select <b>Enable</b> to permit the Bootstrap Protocol (BOOTP) server to assign the IP address from a pool of addresses automatically. <b>Enable</b> is the default.
<b>DHCP</b>	Select <b>Enable</b> to permit the Dynamic Host Configuration Protocol (DHCP) to assign a leased IP address to the xDirect unit automatically. <b>Enable</b> is the default.



<b>AutoIP</b>	Select <b>Enable</b> to permit the xDirect to generate an IP in the 169.254.x.x address range with a Class B subnet. <b>Enable</b> is the default.
<b>DHCP Host Name</b>	Enter the name of the host on the network providing the IP address.

**Note:** Disabling *BOOTP*, *DHCP*, and *AutoIP* (all three checkboxes) is not advised as the only available IP assignment method will then be *ARP* or serial port.

- When you are finished, click the **OK** button.
- On the main menu, click **Apply Settings**.

### Static IP Address Configuration

You can manually assign an IP address to the unit and enter related network settings.

**To assign an IP address manually:**

- On the main menu, click **Network**.
- Select **Use the following IP configuration**.
- Enter the following (as necessary):

<b>IP Address</b>	If DHCP is not used to assign IP addresses, enter it manually in decimal-dot notation. The IP address must be set to a unique value in the network.
<b>Subnet Mask</b>	A subnet mask defines the number of bits taken from the IP address that are assigned for the host part.
<b>Default Gateway</b>	The gateway address, or router, allows communication to other LAN segments. The gateway address should be the IP address of the router connected to the same LAN segment as the unit. The gateway address must be within the local network.
<b>DNS Server</b>	The DNS server allows the name of a remote machine to be resolved automatically. Enter the IP address of the DNS server. If the device is DHCP enabled, the DHCP server provides the DNS server IP address, which will override this configured value.  <b>Note:</b> This setting is applicable only in Manual Connection mode.

- When you are finished, click the **OK** button.
- On the main menu, click **Apply Settings**.

### Ethernet Configuration

You must specify the speed and direction of data transmission.

**To specify how data will be transmitted:**

- On the main menu, click **Network**.
- Enter the following (as necessary):

<b>Auto Negotiate</b>	With this option, the Ethernet port auto-negotiates the speed and duplex with the hardware endpoint to which it is connected. This is the default. If this option is not selected, complete the fields that become available: ◆ <b>Speed:</b> The speed of data transmission. The default setting is <b>100 Mbps</b> . ◆ <b>Duplex:</b> The direction of data transmission. The default setting is <b>Full</b> .
-----------------------	---

- When you are finished, click the **OK** button.
- On the main menu, click **Apply Settings**.

## Server Configuration

The unit's server values display when you select **Server** from the main menu. The following sections describe the configurable parameters on the Server Settings page.

Figure 5-4 Server Settings

### To configure the xDirect device server settings:

1. On the main menu, click **Server**.
2. Configure or modify the following fields:

#### Server Configuration

<b>Enhanced Password</b>	Select whether to enable advanced password: <ul style="list-style-type: none"> <li>◆ <b>Enable</b>: selecting this option enables advanced password creation, allowing you to create passwords up to 16 bytes in length.</li> <li>◆ <b>Disable</b>: selecting this option disables advanced password creation, allowing you to create basic passwords up to 4 bytes in length.</li> </ul>
<b>Telnet/Web Manager Password</b>	Enter the password required for Telnet configuration and Web Manager access. No password or entering a “blank” password entry will disable default password protection.
<b>Retype Password</b>	Re-enter the password required for Telnet configuration and Web Manager access.

#### Advanced

<b>ARP Cache Timeout (secs)</b>	When the unit communicates with another device on the network, it adds an entry into its ARP table. ARP Cache timeout defines the number of seconds (1-600) before it refreshes this table.
---------------------------------	---

<b>TCP Keepalive (secs)</b>	TCP Keepalive time defines how many seconds the unit waits during an inactive connection before checking its status. If the unit does not receive a response, it drops that connection. Enter a value between <b>0</b> and 60 seconds. <b>0</b> disables keepalive. The default setting is <b>45</b> .
<b>Monitor Mode @ Bootup</b>	Select <b>Disable</b> to disable entry into the monitor mode using the <b>yyy</b> or <b>xx1</b> key sequence at startup. This field prevents the unit from entering monitor mode by interpreting the stream of characters that are received during the device server's initialization at startup. The default setting is <b>Enable</b> .
<b>CPU Performance Mode</b>	Select the xDirect's performance mode. Higher performance settings require more energy. <b>Low</b> is 26 MHz. <b>Regular</b> is 48 MHz; <b>High</b> is 88 MHz. The default is <b>Regular</b> .
<b>HTTP Server Port</b>	This option allows the configuration of the web server port number. The valid range is <b>1-65535</b> . The default setting is 80.
<b>Config Server Port</b>	Not applicable for this product.
<b>MTU Size</b>	The Maximum Transmission Unit (MTU) is the largest physical packet size a network can transmit for TCP and UDP. Enter between <b>512</b> and <b>1400</b> bytes. The default setting is <b>1400</b> bytes.
<b>TCP Re-transmission timeout (ms)</b>	The desired TCP re-transmission timeout value. If the ACK is not received for a packet sent from the xDirect device, then the unit will retransmit the data. The valid range is 500-4000 msec. The default is 500.

3. When you are finished, click the **OK** button.
4. On the main menu, click **Apply Settings**.

## Host List Configuration

The xDirect scrolls through the host list until it connects to a device listed in the host list table. After a successful connection, the unit stops trying to connect to any others. If this connection fails, the unit continues to scroll through the table until the next successful connection.

The host list supports a minimum of 1 and a maximum of 12 entries. Each entry contains an IP address and a port number.

**Note:** The host list is disabled for Manual and Modem Mode. The unit does not accept a data connection from a remote device when the hostlist option is enabled.

### To configure the host list:

1. On the main menu, click **Hostlist**.

Figure 5-5 Hostlist Settings

**Hostlist Settings**

**Retry Settings**

Retry Counter:       Retry Timeout:

**Host Information**

No.	Host Address	Port	No.	Host Address	Port
1	<input type="text" value="0.0.0.0"/>	<input type="text" value="0"/>	2	<input type="text" value="0.0.0.0"/>	<input type="text" value="0"/>
3	<input type="text" value="0.0.0.0"/>	<input type="text" value="0"/>	4	<input type="text" value="0.0.0.0"/>	<input type="text" value="0"/>
5	<input type="text" value="0.0.0.0"/>	<input type="text" value="0"/>	6	<input type="text" value="0.0.0.0"/>	<input type="text" value="0"/>
7	<input type="text" value="0.0.0.0"/>	<input type="text" value="0"/>	8	<input type="text" value="0.0.0.0"/>	<input type="text" value="0"/>
9	<input type="text" value="0.0.0.0"/>	<input type="text" value="0"/>	10	<input type="text" value="0.0.0.0"/>	<input type="text" value="0"/>
11	<input type="text" value="0.0.0.0"/>	<input type="text" value="0"/>	12	<input type="text" value="0.0.0.0"/>	<input type="text" value="0"/>

2. Enter or modify the following fields:

### Retry Settings

<b>Retry Counter</b>	Enter the value for the number of times the xDirect should attempt to retry connecting to the host list. The default setting is <b>3</b> .
<b>Retry Timeout</b>	Enter the duration (in milliseconds) the xDirect should abandon attempting a connection to the host list. The default setting is <b>250</b> .

### Host Information

<b>Host Address</b>	Enter or modify the host's IP address.
<b>Port</b>	Enter the target port number.

3. When you are finished, click the **OK** button.
4. On the main menu, click **Apply Settings**.

## Channel 1 Configuration

The Channel 1 configuration defines how the serial ports respond to network and serial communication.

### Serial Settings

To configure the channel's serial settings:

1. On the main menu, click **Serial Settings** (under **Channel 1**) to display the Serial Settings window.

Figure 5-6 Channel Serial Settings

2. In the available fields, enter the following information:

#### Channel 1

<b>Disable Serial Port</b>	When selected, disables communication through the serial port. The serial port is enabled by default. <b>Note:</b> This feature is not available on single port device servers, since it can only be applied to channel 1.
----------------------------	---

#### Port Settings

<b>Protocol</b>	From the drop-down menu, select the protocol type for the selected channel. The default setting is <b>RS232</b> .
<b>Flow Control</b>	Flow control manages data flow between devices in a network to ensure it is processed efficiently. Too much data arriving before a device is prepared to manage it causes lost or retransmitted data. <b>None</b> is the default.

<b>Baud Rate</b>	The unit and attached serial device, such as a modem, must agree on a speed or baud rate to use for the serial connection. Valid baud rates are 300, 600, 1200, 2400, 4800, 9600, 19200, 38400, 57600, 115200, and 230400 baud. Additionally, 921600 and 460800 baud rates are available when CPU is set to High. The default setting is <b>9600</b> .
<b>Data Bits</b>	Indicates the number of bits in a transmitted data package. The default setting is <b>8</b> .
<b>Parity</b>	Checks for the parity bit. The default setting is <b>None</b> .
<b>Stop Bits</b>	The stop bit follows the data and parity bits in serial communication. It indicates the end of transmission. The default setting is <b>1</b> .

### Pack Control

<b>Enable Packing</b>	Select to enable packing on the xDirect. Two firmware-selectable packing algorithms define how and when packets are sent to the network. The standard algorithm is optimized for applications in which the unit is used in a local environment, allowing for very small delays for single characters, while keeping the packet count low. The alternate packing algorithm minimizes the packet count on the network and is especially useful in applications in a routed Wide Area Network (WAN). Adjusting parameters in this mode can economize the network data stream. Disabled by default.
<b>Idle Gap Time</b>	Select the maximum time for inactivity. The default time is <b>12</b> milliseconds.
<b>Match 2 Byte Sequence</b>	Use to indicate the end of a series of data to be sent as one group. The sequence must occur sequentially to indicate end of the data collection to the xDirect. The default setting is <b>No</b> .
<b>Match Bytes</b>	Use to indicate the end of a series of data to be sent as one group. Set this value to <b>00</b> if specific functions are not needed.
<b>Send Frame Immediate</b>	After the detection of the byte sequence, indicates whether to send the data frame or the entire buffer. Select <b>Yes</b> to send only the data frame. The default setting is <b>No</b> .
<b>Send Trailing Bytes</b>	Select the number of bytes to send after the end-of-sequence characters. The default setting is <b>None</b> .

### Flush Input Buffer (Serial to Network)

<b>With Active Connect</b>	Select <b>Yes</b> to clear the input buffer with a connection that is initiated from the device to the network. The default setting is <b>No</b> .
<b>With Passive Connect</b>	Select <b>Yes</b> to clear the input buffer with a connection initiated from the network to the device. The default setting is <b>No</b> .
<b>At Time of Disconnect</b>	Select <b>Yes</b> to clear the input buffer when the network connection to or from the device is disconnected. The default setting is <b>No</b> .

### Flush Output Buffer (Network to Serial)

<b>With Active Connect</b>	Select <b>Yes</b> to clear the output buffer with a connection that is initiated from the device to the network. The default setting is <b>No</b> .
<b>With Passive Connect</b>	Select <b>Yes</b> to clear the output buffer with a connection initiated from the network to the device. The default setting is <b>No</b> .

<b>At Time of Disconnect</b>	Select <b>Yes</b> to clear the output buffer when the network connection to or from the device is disconnected. The default setting is <b>No</b> .
------------------------------	--

- When you are finished, click the **OK** button.
- On the main menu, click **Apply Settings**.

## Connection Settings - TCP

To configure a channel's TCP settings:

- On the main menu, click **Connection**. The Connection Settings window for the channel displays.

Figure 5-7 TCP Connection Settings

**Connection Settings**

---

**Channel 1**

**Connect Protocol**  
Protocol: TCP

**Connect Mode**

<p><b>Passive Connection:</b></p> <p>Accept Incoming: <span style="border: 1px solid gray; padding: 2px;">Yes</span></p> <p>Password Required: <input type="radio"/> Yes <input checked="" type="radio"/> No</p> <p>Password: <span style="border: 1px solid gray; padding: 2px;"> </span></p> <p>Modem Escape Sequence Pass Through: <input checked="" type="radio"/> Yes <input type="radio"/> No</p>	<p><b>Active Connection:</b></p> <p>Active Connect: <span style="border: 1px solid gray; padding: 2px;">None</span></p> <p>Start Character: 0x<span style="border: 1px solid gray; padding: 2px;">DD</span> (in Hex)</p> <p>Modem Mode: <span style="border: 1px solid gray; padding: 2px;">None</span></p> <p>Show IP Address After RING: <input checked="" type="radio"/> Yes <input type="radio"/> No</p>
---	--

---

**Endpoint Configuration:**

Local Port: <span style="border: 1px solid gray; padding: 2px;">10001</span>	<input type="checkbox"/> Auto increment for active connect
Remote Port: <span style="border: 1px solid gray; padding: 2px;">0</span>	Remote Host: <span style="border: 1px solid gray; padding: 2px;">0.0.0.0</span>

---

**Common Options:**

Telnet Com Port Cntrl: <span style="border: 1px solid gray; padding: 2px;">Disable</span>	Connect Response: <span style="border: 1px solid gray; padding: 2px;">None</span>
Terminal Name: <span style="border: 1px solid gray; padding: 2px;"> </span>	Use Hostlist: <input type="radio"/> Yes <input checked="" type="radio"/> No
	LED: <span style="border: 1px solid gray; padding: 2px;">Blink</span>

---

**Disconnect Mode**

On Mdm_Ctrl_In Drop: <input type="radio"/> Yes <input checked="" type="radio"/> No	Hard Disconnect: <input checked="" type="radio"/> Yes <input type="radio"/> No
Check EOT(Ctrl-D): <input type="radio"/> Yes <input checked="" type="radio"/> No	Inactivity Timeout: <span style="border: 1px solid gray; padding: 2px;">0</span> : <span style="border: 1px solid gray; padding: 2px;">0</span> (mins : secs)

OK

- In the available fields, enter or modify the following information:

### Connect Protocol

<b>Protocol</b>	From the drop-down menu, select <b>TCP</b> .
-----------------	--

### Connect Mode: Passive Connection

<b>Accept Incoming</b>	Select <b>Yes</b> to accept incoming connections. The default setting is <b>Yes</b> .
------------------------	---

<b>Password Required</b>	Determines whether a password is required for an incoming passive connection. This field is not available when a password is set for Telnet mode. The default setting is <b>No</b> .
<b>Password</b>	If <b>Password Required</b> was set to <b>Yes</b> , enter the password for passive connections.
<b>Modem Escape Sequence Pass Through</b>	Disable or enable the xDirect's ability to send the escape sequence. The default is <b>Yes</b> (send the escape sequence).

### Connect Mode: Active Connection

<b>Active Connect</b>	Select <b>None</b> (default) to disable <b>Active Connect</b> . Otherwise, indicate the connection type from the drop-down list: <ul style="list-style-type: none"> <li>◆ <b>With Any Character</b>: Attempts to connect when any character is received from the serial port.</li> <li>◆ <b>With Active Mdm Ctrl In</b>: Accepts external connection requests only when the Modem Control In input is asserted.</li> <li>◆ <b>With Start Character</b>: Attempts to connect when it receives a specific start character from the serial port. The default start character is carriage return.</li> <li>◆ <b>Manual Connection</b>: Attempts to connect when directed by a command string received from the serial port.</li> <li>◆ <b>Auto Start</b>: Automatically connects to the remote IP address and port after booting up.</li> </ul>
<b>Start Character</b>	If Active Connect is set to <b>With Start Character</b> , enter the start character in this field. The default setting is <b>0D</b> .
<b>Modem Mode</b>	Indicates the on-screen response type when in Modem Mode (if <b>Modem Mode</b> is enabled). The default setting is <b>None</b> .
<b>Show IP Address After RING</b>	Indicates whether to display the remote IP address upon connection. The default setting is <b>Yes</b> .

### Endpoint Configuration

<b>Local Port</b>	Enter the local port number.
<b>Auto increment for active connect</b>	Select to auto-increment the local port number for new outgoing connections. The range of auto-incremented port numbers is <b>50,000</b> to <b>59,999</b> and loops back to the beginning when the maximum range is reached. Disabled by default.
<b>Remote Port</b>	Enter the remote port number.
<b>Remote Host</b>	Enter the IP address of the remote device.

### Common Options

<b>Telnet Com Port Cntrl</b>	This field is available for configuration only when <b>Active Connect</b> is set to <b>None</b> . Select <b>Enable</b> to permit Telnet communication to the xDirect unit. The <b>Telnet Com Port Cntrl</b> feature is used in conjunction with the Com Port Redirector (CPR) utility. (See the CPR online Help for details.)
<b>Terminal Name</b>	This field is available for configuration only when <b>Telnet Com Port Cntrl</b> is set to <b>Enable</b> . Use the terminal name for the Telnet terminal type. Enter only one name. When this option is enabled, the unit also reacts to the end of record (EOR) and binary options, which can be used for applications such as terminal emulation to IBM hosts.



<b>Connect Response</b>	A single character is transmitted to the serial port when there is a change in connection state. The default setting is None.
<b>Use Hostlist</b>	If this option is set to <b>Yes</b> , the device server scrolls through the host list until it connects to a device listed in the host list table. Once it connects, the unit stops trying to connect to any others. If this connection fails, the unit continues to scroll through the table until it connects to another IP in the host list.  The host list is disabled for Manual Mode and for Modem Mode. The unit will not accept a data connection from a remote device when the host list option is enabled.
<b>LED</b>	Select <b>Blink</b> for the status LEDs to blink upon connection or <b>None</b> for no LED output. The default setting is Blink.

### Disconnect Mode

<b>On Mdm_Ctrl_In Drop</b>	Set to <b>Yes</b> for the network connection to or from the serial port to disconnect (drop) when <b>Modem Control In</b> transitions from an asserted state to not asserted state. The default setting is <b>No</b> .
<b>Hard Disconnect</b>	When set to <b>Yes</b> , the TCP connection closes even if the remote site does not acknowledge the disconnect request.
<b>Check EOT (Ctrl-D)</b>	Select <b>Yes</b> to drop the connection when <b>Ctrl-D</b> or <b>Hex 04</b> is detected. Both <b>Telnet Com Port Cntrl</b> and <b>Check EOT (Ctrl+D)</b> must be enabled for <b>Disconnect with EOT</b> to function properly. <b>Ctrl+D</b> is only detected going from the serial port to the network. The default setting is <b>No</b> .
<b>Inactivity Timeout</b>	Use this parameter to set an inactivity timeout. The unit drops the connection if there is no activity on the serial line before the set time expires. Enter time in the format mm:ss, where m is the number of minutes and s is the number of seconds. To disable the inactivity timeout, enter <b>00:00</b> .

3. When you are finished, click the **OK** button.
4. On the main menu, click **Apply Settings**.

### Connection Settings - UDP

#### To configure a channel's UDP settings:

1. On the main menu, click **Connection**. The Connection Settings window for the selected channel displays.
2. In the available fields, enter or modify the following information:

Figure 5-8 UDP Connection Settings

**Connection Settings**

---

**Channel 1**

**Connect Protocol**

Protocol: UDP

**Datagram Mode:**

Datagram Type: 00      Accept Incoming: Yes

**Endpoint Configuration:**

Local Port: 10001      Remote Port: 0

Remote Host: 0.0.0.0       Use Broadcast

**Device Address Table:**

No.	Dev Addr	No.	Dev Addr	No.	Dev Addr	No.	Dev Addr
0	<span style="border: 1px solid gray; padding: 2px;">0</span>	1	<span style="border: 1px solid gray; padding: 2px;">0</span>	2	<span style="border: 1px solid gray; padding: 2px;">0</span>	3	<span style="border: 1px solid gray; padding: 2px;">0</span>
4	<span style="border: 1px solid gray; padding: 2px;">0</span>	5	<span style="border: 1px solid gray; padding: 2px;">0</span>	6	<span style="border: 1px solid gray; padding: 2px;">0</span>	7	<span style="border: 1px solid gray; padding: 2px;">0</span>
8	<span style="border: 1px solid gray; padding: 2px;">0</span>	9	<span style="border: 1px solid gray; padding: 2px;">0</span>	10	<span style="border: 1px solid gray; padding: 2px;">0</span>	11	<span style="border: 1px solid gray; padding: 2px;">0</span>
12	<span style="border: 1px solid gray; padding: 2px;">0</span>	13	<span style="border: 1px solid gray; padding: 2px;">0</span>	14	<span style="border: 1px solid gray; padding: 2px;">0</span>	15	<span style="border: 1px solid gray; padding: 2px;">0</span>

OK

**Connect Protocol**

<b>Protocol</b>	Select <b>UDP</b> from the drop-down menu.
-----------------	--

**Datagram Mode**

<b>Datagram Type</b>	Configures the remote IP or network broadcast address and the remote port. Enter <b>01</b> for directed or broadcast UDP. The default setting is <b>00</b> .
<b>Accept Incoming</b>	Select <b>Yes</b> to accept incoming UDP datagrams. The default setting is <b>Yes</b> .

**Endpoint Configuration**

<b>Local Port</b>	Enter the local port number.
<b>Remote Port</b>	Enter the port number of the remote device.
<b>Remote Host</b>	Enter the IP address of the remote device.
<b>Use Broadcast</b>	Select to broadcast the UDP datagram. Datagrams of type 01 can be sent as a broadcast by enabling this option. The default is not to broadcast. <i>Note: Datagrams are sent as subnet-directed broadcasts.</i>
<b>Device Address Table</b>	The table is enabled when <b>Datagram Type</b> is set to <b>FD</b> . Enter values between <b>1</b> and <b>255</b> to identify units on the local network of device servers. <i>Note: Lantronix Tech Support supports Datagram type 01. Datagram Type FD is for OEM use.</i>

3. When you are finished, click the **OK** button.
4. On the main menu, click **Apply Settings**.

## Apply Settings

1. To save and apply the configuration changes to the device server, click the **Apply Settings** button.

**Note:** Clicking **OK** on each page does not change the configuration on the device. Clicking the **OK** button tells the xDirect what changes to use; the **Apply Settings** button makes the changes permanent and reboots the xDirect.

## Apply Defaults

1. Click the **Apply Defaults** button to set the device server back to the default settings. For details see [Default Settings \(Option 7\)](#).
2. Click **Yes** to set factory settings, or click **No** to cancel.

Figure 5-9 Apply Settings and Apply Defaults

The screenshot shows the xDirect web manager interface. The left sidebar has a navigation menu with the following items: Network, Server, Serial Tunnel, Hostlist, Channel 1, Serial Settings, Connection, Apply Settings (highlighted with an orange arrow), and Apply Defaults (highlighted with an orange arrow). The main content area is titled 'Device Status' and contains a table of device information.

Product Information	
Firmware Version:	V6.9.0.0
Build Date:	06-Sep-2012
Network Settings	
MAC Address:	00-20-4A-9D-02-8B
Network Mode:	Wired
DHCP HostName:	< None >
IP Address:	172.19.100.39
Default Gateway:	172.19.0.1
DNS Server:	172.19.1.1
MTU:	1400
Line settings	
Line 1:	RS232, 9600, 8, None, 1, None.

WebManager Version: 2.0.0.0 Copyright © Lantronix, Inc. 2007-2012. All rights reserved.

## 6: Configuration Via Telnet or Serial Port (Setup Mode)

You must configure the unit so it can communicate on a network with your serial device. As an alternative to using a web browser, as described in the previous chapter, you can use the following procedures remotely or locally:

- ◆ Use a Telnet connection to configure the unit over the network.
- ◆ Use a terminal or terminal emulation program to access the serial port locally.

The series of prompts at which you enter configuration settings is called **Setup Mode**.

**Note:** Detailed information about other setup methods are available from your Lantronix Sales Associate.

The unit's configuration is stored in nonvolatile memory and is retained without power. You can change the configuration at any time. The unit performs a reset after the configuration has been changed and stored.

This chapter explains how to access and use Setup Mode. To complete the configuration, continue with [Chapter 7: Setup Mode: Server Configuration](#), [Chapter 8: Setup Mode: Channel Configuration](#) and [Chapter 9: Setup Mode: Advanced Settings](#).

**Note:** The menus in the configuration chapters show a typical device. Your device may have different configuration options.

### Accessing Setup Mode

#### Telnet Connection

To configure the unit over the network, establish a Telnet connection to port 9999.

**Note:** You can also use DeviceInstaller to access Telnet. Select the device from the main window list, and click the **Telnet Configuration** tab. Skip steps 1 and 2.

**To establish a Telnet connection:**

1. From the Windows **Start** menu, click **Run** and type the following command, where x.x.x.x is the IP address, and 9999 is the unit's fixed network configuration port number:

Windows: telnet x.x.x.x 9999

UNIX: telnet x.x.x.x:9999

2. Click **OK**. The following information and login prompts display (see [Figure 6-1](#)).

**Figure 6-1 MAC Address and Login Prompt**

```
*** Lantronix xDirect 232 Device Server ***
MAC address 00204A9D028B
Software version V6.9.0.0RC3 (120828) XDIRECT
AES library version 1.8.2.1
User Name :admin
```

Password :----  
Press Enter for Setup Mode

3. Enter **User Name** (user name is admin and cannot be changed). Pressing the **Enter** key after entry is not necessary. The **Password** field will appear.
4. Enter **Password** (default password is PASS). Pressing the **Enter** key after entry is not necessary. You will be prompted to enter Setup Mode.

**Note:** Password can be modified or disabled. See [Server Configuration \(on page 26\)](#).

5. To enter Setup Mode, press **Enter within 5 seconds**. The configuration settings display (see [Figure 6-2](#)), followed by the Change Setup menu.

**Figure 6-2 Setup Menu Options**

```

*** basic parameters
Hardware: Ethernet TPI
IP addr - 0.0.0.0/DHCP/BOOTP/AutoIP, no gateway set
DNS Server not set
Telnet config password set
DHCP device name : not set
DHCP FQDN option: Disabled

*** Security
SNMP is          enabled
SNMP Community Name: public
Telnet Setup is  enabled
TFTP Download is enabled
Port 77FEh is    enabled
Web Server is    enabled
Web Setup is     enabled
ECHO is          disabled
Encryption is    disabled
Enhanced Password is disabled

*** Channel 1
Baudrate 9600, I/F Mode 4C, Flow 00
Port 10001
Connect Mode : C0
Send '+' in Modem Mode enabled
Show IP addr after 'RING' enabled
Auto increment source port disabled
Remote IP adr: --- none ---, Port 00000
Disconn Mode : 00
Flush  Mode : 00

*** Expert
TCP Keepalive   : 45s
ARP cache timeout: 600s
CPU performance: Regular
Monitor Mode @ bootup : enabled
HTTP Port Number : 80
MTU Size: 1400

```

```
TCP Re-transmission timeout: 500 ms
Alternate MAC: disabled
Ethernet connection type: auto-negotiate
```

Change Setup:

```
0 Server
1 Channel 1
5 Expert
6 Security
7 Defaults
8 Exit without save
9 Save and exit          Your choice? _
```

6. Select an option on the menu by entering the number of the option in the **Your choice?** field and pressing **Enter**.
7. To enter a value for a parameter, type the value and press **Enter**, or to confirm a current value, just press **Enter**.
8. When you are finished, save the new configuration (option **9**). The unit reboots.

## Serial Port Connection

To configure the unit through a serial connection:

1. Connect a console terminal or PC running a terminal emulation program to your unit's serial port. The default serial port settings are **9600 baud, 8 bits, no parity, 1-stop bit, no-flow control**.
2. Reset the xDirect unit by cycling the unit's power (turning the power off and back on). Immediately upon resetting the device, enter three lowercase **x** characters (**xxx**).

**Note:** *The easiest way to enter Setup Mode is to hold down the **x** key at the terminal (or emulation) while resetting the unit. **You must do this within three seconds of resetting the xDirect.***

At this point, the screen display is the same as when you use a Telnet connection. To continue, go to [step 6](#) in [Telnet Connection](#) above.

## Exiting Setup Mode

**Two options through which to exit setup mode:**

- ◆ To save all changes and reboot the device, select option **9 Save and exit** from the Change Setup menu. All values are stored in nonvolatile memory.
- ◆ To exit the configuration mode without saving any changes or rebooting, select option **8 Exit without save** from the Change Setup menu.

## 7: Setup Mode: Server Configuration

This chapter explains how to configure the network settings.

**Note:** Current values display in parentheses.

### Server Configuration (Option 0)

The unit's basic network parameters display when you select **Server configuration** (option 0). The **IP Address**, **Set Gateway IP Address**, and **Netmask** fields display the current values.

**Figure 7-1 Network Settings**

```
IP Address : (000) .(000) .(000) .(000)
Set Gateway IP Address (N) ?
Netmask: Number of Bits for Host Part (0=default) (0)
Set DNS Server IP addr (N) ?
Change Telnet/Web Manager password (N) ?
Change DHCP device name (not set) ? (N) ?
Enable DHCP FQDN option : (N) ?
```

### IP Address

If DHCP is not used to assign IP addresses, enter the IP address manually. The IP address must be set to a unique value in the network. Enter each octet and press **Enter** between each section. The current value displays in parentheses.

```
IP Address : (000) (000) (000) (000) _
```

If DHCP is used, the third octet of the IP address sets the BootP/DHCP/AutoIP options. The following table shows the bits you can manually configure to force the xDirect to disable AutoIP, DHCP, or BootP. To disable an option, set the appropriate bit.

**Table 7-2 BootP/DHCP/AutoIP options**

Options	Bit	Value
AutoIP	0	1
DHCP	1	2
BootP	2	4

For example, if the third octet is 0.0.5.0, the AutoIP and BootP options are disabled; only DHCP is enabled. (The value 5 results from adding the binary equivalents of 0 and 2.) This is the most common setting when using DHCP.

## Set Gateway IP Address

The gateway address, or router, allows communication to other LAN segments. The gateway address should be the IP address of the router connected to the same LAN segment as the unit. The gateway address must be within the local network. The default setting is **N** (No), meaning the gateway address has not been set. To set the gateway address, type **Y** and enter the address.

```
Set Gateway IP Address (N) ? Y
Gateway IP addr (000) (000) (000) (000) _
```

## Netmask: Number of Bits for Host Part

A netmask defines the number of bits taken from the IP address that are assigned for the host part.

```
Netmask: Number of Bits for Host Part (0=default) (0) _
```

**Note:** Class A: 24 bits; Class B: 16 bits; Class C: 8 bits

The unit prompts for the number of host bits to be entered, then calculates the netmask, which appears in standard decimal-dot notation (for example, 255.255.255.0) when the saved parameters display. The default setting is **0**.

**Table 7-3 Standard IP Network Netmasks**

Options	Bit	Value
<b>A</b>	24	255.0.0.0
<b>B</b>	16	255.255.0.0
<b>C</b>	8	255.255.255.0

## Set DNS Server IP Address

The DNS server allows the name of a remote machine to be resolved automatically. The default is **N** (No), indicating the DNS server address has not been set. To set the DNS server address, type **Y**. At the prompt, enter the DNS server address. If the device is DHCP enabled, the DHCP server provides the DNS server IP address, which will override this configured value.

**Note:** This setting is applicable only in Manual Connection mode.

```
Set DNS Server IP addr ((N) ?
```



## Change Telnet Configuration Password

Setting the Telnet configuration password prevents unauthorized access to the setup menu through a Telnet connection to port 9999 or through web pages. The password must have 4 characters. The default setting is **N** (No).

```
Change Telnet/Web Manager password (N) ? _
```

An enhanced password setting (for Telnet access only) of 16 characters is available under [Security Settings \(Option 6\)](#) and can be modified or disabled via Web Manager (see [Server Configuration](#)).

**Note:** *You do not need a password to access the Setup Mode window by a serial connection.*

## DHCP Name

If a DHCP server has automatically assigned the IP address and network settings, you can discover the unit by using the DeviceInstaller network search feature or Monitor Mode (see [Chapter 11: Monitor Mode](#)).

**Note:** *When you enter Monitor Mode from the serial port with network connection enabled and issue the **NC** (Network Communication) command, you see the unit's IP configuration.*

There are three methods for assigning DHCP names to the unit.

- ◆ **Default DHCP Name:** If you do not change the DHCP name, and you are using an IP of 0.0.0.0, then the DHCP name defaults to XX.XX.XX.XX (XXXXXX is the last 6 digits of the MAC address shown on the label on the bottom/side of the unit). For example, if the MAC address is 00-20-4A-12-34-56, then the default DHCP name is C123456.
- ◆ **Custom DHCP Name:** You can create your own DHCP name. If you are using an IP address of 0.0.0.0, then the last option in Server configuration is **Change DHCP device name**. This option allows you to change the DHCP name to an alphanumeric name (LTX in our example).

```
Change DHCP device name (not set) ? (N) Y
Enter new DHCP device Name : LTX
```

- ◆ **Numeric DHCP Name:** You can change the DHCP name by specifying the last octet of the IP address. When you use this method, the DHCP name is LTXYY where YY is what you chose for the last octet of the IP address. If the IP address you specify is 0.0.0.12, then the DHCP name is LTX12. This method only works with 2 digit numbers (01-99).

## 8: Setup Mode: Channel Configuration

This chapter explains how to configure the serial port.

### Notes:

- ◆ Current values display in parenthesis.
- ◆ You must enter some values in hexadecimal notation. See [Appendix E: Binary to Hexadecimal Conversions](#).

### Channel 1 (Option 1)

Select **Channel 1 (Option 1)** from the Change Setup menu to define how the serial port responds to network and serial communications. The following sections describe the configurable parameters within the **Channel** configuration menu.

Figure 8-1 Serial Port Settings

```
Baudrate (9600) ?
I/F Mode (4C) ?
Flow (00) ?
Port No (10001) ?
ConnectMode (C0) ?
Send '+++ ' in Modem Mode (Y) ?
Show IP addr after 'RING' (Y) ?
Auto increment source port (N) ?
Remote IP Address : (000) .(000) .(000) .(000)
Remote Port (0) ?
DisConnMode (00) ?
FlushMode (00) ?
DisConnTime (00:00) ? :
SendChar 1 (00) ?
SendChar 2 (00) ?
```

### Baudrate

The unit and attached serial device, such as a modem, must agree on a speed or baud rate to use for the serial connection. Valid baud rates are 300, 600, 1200, 2400, 4800, 9600 (default), 19200, 38400, 57600, 115200, and 230400 baud. xDirect also supports high-performance baud rates of 460800 and 921600 bits per second. See [CPU Performance \(on page 55\)](#).

```
Baudrate (9600) ? _
```

## I/F (Interface) Mode

The Interface (I/F) Mode is a bit-coded byte entered in hexadecimal notation. The default setting is **4C**.

I/F Mode (4C) ? \_

The following table displays available I/F Mode options:

**Note:** All bit positions in the table that are blank represent “don’t care” bits for that particular option, which can be set to either a 0 or 1 value.

**Table 8-2 Interface Mode Options**

I/F Mode Option	7	6	5	4	3	2	1	0
RS-232C <sup>(1)</sup>							0	0
RS-422/485 4-wire							0	1
RS-485 2-wire							1	1
7 Bit					1	0		
8 Bit					1	1		
No Parity			0	0				
Even Parity			1	1				
Odd Parity			0	1				
1 stop bit	0	1						
2 stop bits <sup>(1)</sup>	1	1						

(1) 2 stop bits are implemented by the software. This might influence performance.

The following table demonstrates how to build some common Interface Mode settings:

**Table 8-3 Common Interface Mode Settings**

Common I/F Mode Setting	Binary	Hex
RS-232C, 8-bit, No Parity, 1 stop bit	0100 1100	4C
RS-232C, 7-bit, Even Parity, 1 stop bit	0111 1000	78
RS-485 2-wire, 8-bit, No Parity, 1 stop bit	0100 1111	4F
RS-422, 8-bit, Odd Parity, 1 stop bit	0101 1101	5D

## Flow

Flow control sets the local handshaking method for stopping serial input/output. The default setting is **00**.

Flow (00) ? \_

Use the following table to select flow control options:

**Table 8-4 Flow Control Options**

Flow Control Option	Hex
No flow control	00
XON/XOFF flow control	01
Hardware handshake with RTS/CTS lines	02
XON/XOFF pass characters to host	05

## Port Number

The setting represents the source port number in TCP connections. It is the number that identifies the channel for remote initiating connections.

Port No (10001) ? \_

The default setting for Port 1 is **10001**. The range is **1-65535**, except for the following reserved port numbers:

**Table 8-5 Reserved Port Numbers**

Port Numbers	Reserved for
1 – 1024	Reserved (well known ports)
9999	Telnet setup
14000-14009	Reserved for Redirector
30704	Reserved (77F0h)
30718	Reserved (77FEh)

**Warning:** *We recommend that you not use the reserved port numbers for this setting as incorrect operation may result.*

Use Port **0** for the outgoing local port to change with each connection. The port range is **50,000-59,999**. Each subsequent connection increments the number by 1 (it wraps back around to 50,000).

Only use this automatic port increment feature to initiate a connection using TCP. Set the port to a non-zero value when the unit is in a passive mode or when using UDP instead of TCP.

## Connect Mode

Connect Mode defines how the unit makes a connection, and how it reacts to incoming connections over the network.

ConnectMode (C0) ? \_

Enter Connect Mode options in hexadecimal notation. The default setting is **C0**.

**Note:** All bit positions in the table that are blank represent “don’t care” bits for that particular option, which can be set to either a 0 or 1 value.

**Table 8-6 Connect Mode Options**

Connect Mode Option	7	6	5	4	3	2	1	0
<b>a) Incoming Connection</b>								
Never accept incoming	0	0	0					
Accept with active Modem Control In	0	1	0					
Always Accept	1	1	0					
<b>b) Response</b>								
Nothing (quiet)				0				
Character response (C=connect, D=disconnect, N=unreachable)				1				
<b>c) Active Startup</b>								
No active startup					0	0	0	0
With any character					0	0	0	1
With active Modem Control In					0	0	1	0
With a specific start character					0	0	1	1
Manual connection					0	1	0	0
Autostart					0	1	0	1
Hostlist	0	0	1	0				
<b>d) Datagram Type</b>								
Directed UDP					1	1	0	0
<b>e) Modem Mode</b>								
No Echo			0	0		1	1	
Data Echo & Modem Response (Numeric)			0	1		1	1	1
Data Echo & Modem Response (Verbose)			0	1		1	1	0
Modem Response Only (Numeric)			0	0	1	1	1	1
Modem Response Only (Verbose)			0	0	1	1	1	0

### a) Incoming Connection

<b>Never Accept Incoming</b>	Rejects all external connection attempts.
<b>Accept with active Modem Control in</b>	Accepts external connection requests only when <b>Modem Control In</b> input is asserted. Cannot be used with Modem Mode.
<b>Always Accept</b>	Accepts any incoming connection when a connection is not already established. Default setting.

## b) Response

<b>Character Response</b>	<p>A single character is transmitted to the serial port when there is a change in connection state: <b>C</b> = connected, <b>D</b> = disconnected, <b>N</b> = host unreachable. The IP address of the host connecting to the CoBos device will be provided when you use verbose mode.</p> <p>This option is overridden when the <b>Active Start Modem Mode</b> or <b>Active Start Host List</b> is in effect. Default setting is <b>Nothing (quiet)</b>.</p>
---------------------------	--

## c) Active Startup

<b>No Active Startup</b>	Does <i>not</i> attempt to initiate a connection under any circumstance. Default setting.
<b>With Any Character</b>	Attempts to connect when any character is received from the serial port.
<b>With active Modem Control in</b>	Attempts to connect when the <b>Modem Control In</b> input changes from not asserted to asserted.
<b>With a Specific Start Character</b>	Attempts to connect when it receives a specific start character from the serial port. The default start character is carriage return.
<b>Manual Connection</b>	<p>Attempts to connect when directed by a command string received from the serial port. The first character of the command string must be a <b>C</b> (ASCII 0x43), and the last character must be either a carriage return (ASCII 0x0D) or a line feed (0x0A). No blanks or space characters may be in the command string. Between the first and last command string characters must be a full or partial destination IP address and may be a destination port number.</p> <p>The IP address must be in standard decimal-dot notation and may be a partial address, representing the least significant 1, 2, or 3 bytes of the remote IP address. The period is required between each pair of IP address numbers.</p> <p>If present, the port number must follow the IP address, must be presented as a decimal number in the range <b>1-65535</b>, and must be preceded by a forward slash (ASCII 0x2F). The slash separates the IP address and the port number. If you omit the port number from a command string, the internally stored remote port number starts a connection.</p> <p>If a partial IP address is presented in a command string, it is interpreted to be the least significant bytes of the IP address and uses the internally stored remote IP address to provide the most significant bytes of the IP address. If the IP address entered is 0.0.0.0/0, the device server enters Monitor Mode.</p> <p>For example, if the remote IP address already configured in the unit is 129.1.2.3, then an example command string would be C3/7. (This would connect to 129.1.2.3 and port 7.) You may also use a different ending for the connection string. For example, C50.1/23 would connect you to 129.1.50.1 and port 23.</p> <p>If an IP address does not follow the first command string character (which is "C"), the subsequent character string is interpreted as the host name and domain to be used in DNS lookup. This character string can include a destination port number as well. The port number can be preceded by either a forward slash (/) or a colon (:).</p>

**Table 8-7 Manual Connection Address Example**

<b>Command String</b>	<b>Result if remote IP is 129.1.2.3 and remote port is 1234</b>
<b>C121.2.4.5/1</b>	Complete override; connection is started with host 121.2.4.5, port 1.
<b>C5</b>	Connects to 129.1.2.5, port 1234.
<b>C28.10/12</b>	Connects to 129.1.28.10, port 12.

Command String	Result if remote IP is 129.1.2.3 and remote port is 1234
<b>C0.0.0.0/0</b>	Enters Monitor Mode.
<b>Cwww.lantronix.com/80</b>	Tries to connect to the Lantronix web server if the <hostname:domain> ( <a href="http://www.lantronix.com">www.lantronix.com</a> ) is configured in the DNS server database.

### Host List Option (Hostlist)

<b>Autostart (Automatic Connection)</b>	If you enable <b>Autostart</b> , the unit automatically connects to the remote IP address and remote port specified when the firmware starts.
<b>Hostlist</b>	<p>If you enable this option, the device server scrolls through the hostlist until it connects to a device listed in the hostlist table. Once it connects, the unit stops trying to connect to any others. If this connection fails, the unit continues to scroll through the table until it is able to connect to another IP in the hostlist.</p> <p>Hostlist supports a minimum of <b>1</b> and a maximum of <b>12</b> entries. Each entry contains the IP address and the port number.</p> <p>The hostlist is disabled for Manual and Modem Modes. The unit does not accept a data connection from a remote device when the hostlist option is enabled.</p>

**Figure 8-8 Host List Option (Hostlist)**

```

Baudrate (9600) ?
I/F Mode (4C) ?
Flow (00) ?
Port No (10001) ?
ConnectMode (25) ?
Send '+++ ' in Modem Mode (Y) ?
Show IP addr after 'RING' (Y) ?
Auto increment source port (N) ?

Hostlist :
01. IP : 172.019.000.000 Port : 00023
02. IP : 019.019.002.000 Port : 03001
03. IP : 172.019.003.000 Port : 00000

Change Hostlist ? (N) ? Y
01. IP address : (172) .(019) .(000) .(000) 001 Port : (23) ?
02. IP address : (019) 172.(019) .(002) .(000) 002 Port : (30) ?
03. IP address : (172) .(019) .(003) 000.(000) 003 Port : (0) ?
04. IP address : (000) .(000) .(000) .(000)

Hostlist :
01. IP : 172.019.001.000 Port : 00023
02. IP : 172.019.002.000 Port : 03001
03. IP : 172.019.003.000 Port : 10001

Change Hostlist ? (N) ?
Hostlist Retrycounter (3)
Hostlist Retrytimeout (250) ?
DisConnMode (01) ?
FlushMode (00) ?
DisconnTime (00:00) ?:

```

SendChar 1 (00)  
SendChar 2 (00)

#### To enable the hostlist:

1. Enter a Connect Mode of 0x20 (2X), where X is any digit. The menu shows you a list of current entries already defined in the product.
2. To delete, modify, or add an entry, select Yes. If you enter an IP address of 0.0.0.0, that entry and all others after it are deleted.
3. After completing the hostlist, repeat the previous step if necessary to edit the hostlist again.
4. For **Retrycounter**, enter the number of times the Lantronix unit should try to make a good network connection to a hostlist entry that it has successfully ARPed. The range is **1-15**, with the default set to **3**.
5. For **Retrytimeout**, enter the number of seconds the unit should wait before failing an attempted connection. The time is stored as units of milliseconds in the range of **10-65535**. The default setting is **250**.

#### d) Datagram Type

<b>Directed UDP</b>	<p>When selecting this option, the prompt requests the Datagram type. Enter <b>01</b> for directed or broadcast UDP. Datagrams of type 01 can be sent as a broadcast by enabling this option. The default is not to broadcast.</p> <p><b>Note:</b> <i>Datagrams are sent as subnet-directed broadcasts.</i></p> <p>When the UDP option is in effect, the unit never attempts to initiate a TCP connection because it uses UDP datagrams to send and receive data.</p>
---------------------	---

#### e) Modem Mode

In Modem (Emulation) Mode, the unit presents a modem interface to the attached serial device. It accepts AT-style modem commands and handles the modem signals correctly.

Normally, there is a modem connected to a local PC and a modem connected to a remote machine. A user must dial from the local PC to the remote machine, accumulating phone charges for each connection. Modem Mode allows you to replace modems with xDirects, and to use an Ethernet connection instead of a phone call. By not having to change communications applications, you avoid potentially expensive phone calls.

To select Modem Mode, set the Connect Mode to **C6** (no echo), **D6** (echo with full verbose), **D7** (echo with numeric response), **CF** (modem responses only, numeric response), or **CE** (modem responses only, full verbose).

**Note:** *If the unit is in Modem Mode, and the serial port is idle, the unit can still accept network TCP connections to the serial port if Connect Mode is set to **C6** (no echo), **D6** (echo with full verbose), **D7** (echo with numeric response), **CF** (modem responses only, numeric response), or **CE** (modem responses only, full verbose).*

<b>Without Echo</b>	<p>In Modem Mode, echo refers to the echo of all of the characters entered in command mode; it does <i>not mean</i> to echo data that is transferred. Quiet Mode (without echo) refers to the modem <i>not</i> sending an answer to the commands received (or displaying what was typed).</p>
---------------------	---



<b>Data Echo &amp; Modem Response</b>	<p><b>Full Verbose:</b> The unit echoes modem commands and responds to a command with a message string shown in the table below.</p> <p><b>Numeric Response:</b> The unit echoes modem commands and responds to a command with a numeric response.</p>
<b>Modem Responses Only</b>	<p><b>Full Verbose:</b> The unit does not echo modem commands and responds to a command with a message string shown in the table below.</p> <p><b>Numeric Response:</b> The unit does not echo modem commands and responds to a command with a numeric response.</p>

Table 8-9 Modem Mode Messages

Message	Meaning
<b>Full Verbose</b>	
OK	Command was executed without error.
CONNECT	A network connection has been established.
NO CARRIER	A network connection has been closed.
RING n.n.n.n.	A remote device, having IP address n.n.n.n, is connecting to this device.
<b>Numeric Response</b>	
0	OK
1	Connected
2	Ring
3	No Carrier
4	Error

Received commands must begin with the two-character sequence **AT** and be terminated with a carriage return character.

The unit ignores any character sequence received *not* starting with **AT**, and only recognizes and processes single **AT**-style commands. The unit treats compound **AT** commands as unrecognized commands.

If the **Full Verbose** option is in effect, the unit responds to an unrecognized command string that is otherwise formatted correctly (begins with **AT** and ends with carriage return) with the "OK" message and takes no further action.

If the **Numeric Response** option is in effect, the unit responds to an unrecognized command string that is otherwise formatted correctly with a "0" message and takes no further action.

When an active connection is in effect, the unit transfers data and does not process commands received from the serial interface.

When a connection is terminated or lost, the unit reverts to command mode.

When an active connection is in effect, the unit terminates the connection if it receives the following sequence from the attached serial device:

- ◆ No serial data is received for one second.
- ◆ The character sequence +++ is received, with no more than one second between each two characters.
- ◆ No serial data is received for one second after the last + character. At this time, the unit responds affirmatively per the selected echo/response mode.

- ◆ The character string **ATH** is received, terminated with a carriage return. The unit responds affirmatively according to the selected echo/response mode and drops the network connection. The serial interface reverts to accepting command strings.

If this sequence is not followed, the unit remains in data transfer mode.

**Table 8-10 Modem Mode Commands**

<b>Modem Mode Command</b>	<b>Function</b>
<b>ATDTx.x.x.x,pppp or ATDTx.x.x.x/pppp or ATDTx.x.x.x:pppp</b>	Makes a connection to an IP address (x.x.x.x) and a remote port number (pppp).
<b>ATDTx.x.x.x</b>	Makes a connection to an IP address (x.x.x.x) and the remote port number defined within the unit.
<b>ATD0.0.0.0</b>	Forces the unit into Monitor Mode if a remote IP address and port number are defined within the unit.
<b>ATD or ATDT</b>	Forces the unit into Monitor Mode if a remote IP address and port number are not defined within the unit.
<b>ATDx.x.x.x</b>	Makes a connection to an IP address (x.x.x.x) and the remote port number defined within the unit.
<b>ATH</b>	Hangs up the connection (Entered as +++ATH ).
<b>ATS0=n</b>	Enables or disables connections from the network going to the serial port. n=0 disables the ability to make a connection from the network to the serial port. n=1-9 enables the ability to make a connection from the network to the serial port. n>1-9 is invalid.
<b>ATEn</b>	Enables or disables character echo and responses. n=0 disables character echo and responses. n=1 enables character echo and responses.
<b>ATVn</b>	Enables numeric response or full verbose. n=0 enables numeric response. n=1 enables full verbose.

**Note:** The unit recognizes these AT commands as single commands such as ATE0 or ATV1; it does not recognize compound commands such as ATE0V.

## Send the Escape Sequence (+++) in Modem Mode

Send '+++' in Modem Mode (Y) ? \_

Disable or enable the xDirect's ability to send the escape sequence. The default setting is Y (Yes) (send the escape sequence).

## Show IP Address after 'RING'

Show IP addr after "RING" (Y) ?

Disable or enable the xDirect's ability to show the IP address after RING in Modem Mode. The default is **Y** (Yes), to show the IP address.

## Auto Increment Source Port

Auto increment source port (N) ? \_

**Y** (Yes) auto increment the source port. The xDirect increments the port number used with each new connection.

## Remote IP Address

This is the destination IP address used with an outgoing connection.

Remote IP Address : (000) (000) (000) (000) \_

**Note:** This option does not display when Hostlist is enabled from the **ConnectMode** prompt (see [Connect Mode](#) for more information).

## Remote Port

You must set the remote TCP port number for the unit to make outgoing connections. This parameter defines the port number on the target host to which a connection is attempted.

Remote Port (0) ? \_

To connect an ASCII terminal to a host using the unit for login purposes, use the remote port number 23 (Internet standard port number for Telnet services).

**Note:** This option does not display when Hostlist is enabled from the **ConnectMode** prompt (see [Connect Mode](#) for more information).

## Disconnect Mode (DisConnMode)

This setting determines the conditions under which the unit will cause a network connection to terminate. The default setting is **00**.

DisConnMode (00) ? \_

### Notes:

- ◆ In *DisConnMode* (Disconnect Mode), when **Modem Control In** is not asserted, this condition either drops the connection or is ignored.
- ◆ All bit positions in the table that are blank represent “don’t care” bits for that particular option, which can be set to either a 0 or 1 value.

Table 8-11 Disconnect Mode Options

Disconnect Mode Option	7	6	5	4	3	2	1	0
Disconnect when Modem Control In is not asserted <sup>(6)</sup>	1							
Ignore Modem Control In	0							
Telnet Com Port Cntrl and terminal type setup <sup>(1)</sup>		1						
Channel (port) password <sup>(2)</sup>				1				
Hard disconnect <sup>(3)</sup>					0			
Disable hard disconnect					1			
State LED off with connection <sup>(4)</sup>								1
Disconnect with EOT (^D) <sup>(5)</sup>			1					

- (1) The Telnet Com Port Control feature is used in conjunction with Com Port Redirector. The xDirect sends the **Terminal Type** upon an outgoing connection.
- (2) A password is required for a connection to the serial port from the network.
- (3) The TCP connection closes even if the remote site does not acknowledge the disconnection.
- (4) When there is a network connection to or from the serial port, the state LED turns off instead of blinking.
- (5) When **Ctrl+D** or **Hex 04** is detected, the connection is dropped. Both **Telnet Com Port Cntrl** and **Disconnect with EOT** must be enabled for **Disconnect with EOT** to function properly. **Ctrl+D** is only detected going from the serial port to the network.
- (6) When **Modem Control In** transitions from a high state to a low state, the network connection to or from the serial port drops.

## Flush Mode (Buffer Flushing)

Using this parameter, you can control line handling and network buffers with connection startup and disconnect. The default setting is **00.\**

```
FlushMode (00) ? _
```

You can also select between two different packing algorithms.

**Note:** All bit positions in the table that are blank represent “don’t care” bits for that particular option, which can be set to either a 0 or 1 value.

Table 8-12 Flush Mode Options

Function	7	6	5	4	3	2	1	0
<b>Input Buffer (Serial to Network)</b>								
Clear with a connection initiated from the device to the network				1				
Clear with a connection initiated from the network to the device			1					
Clear when the network connection to or from the device is disconnected		1						
<b>Output Buffer (Network to Serial)</b>								
Clear with a connection initiated from the device to the network								1
Clear with a connection initiated from the network to the device							1	
Clear when the network connection to or from the device is disconnected						1		
<b>Alternate Packing Algorithm (Pack Control)</b>								
Enable	1							

## Pack Control

The packing algorithms define how and when packets are sent to the network. The standard algorithm is optimized for applications in which the unit is used in a local environment, allowing for very small delays for single characters, while keeping the packet count low. The alternate packing algorithm minimizes the packet count on the network and is especially useful in applications in a routed Wide Area Network (WAN). Adjusting parameters in this mode can economize the network data stream.

Pack control settings are enabled in Flush Mode. Set this value to **00** if you do not need specific functions.

**Note:** All bit positions in the table that are blank represent “don’t care” bits for that particular option, which can be set to either a 0 or 1 value.

**Table 8-13 Pack Control Options**

Option	7	6	5	4	3	2	1	0
<b>Packing Interval</b>								
Interval: 12 msec							0	0
Interval: 52 msec							0	1
Interval: 250 msec							1	0
Interval: 5 sec							1	1
<b>Trailing Characters</b>								
None					0	0		
One					0	1		
Two					1	0		
2-Byte Send Character Sequence				1				
Send Immediately After Send chars			1					

### Packing Interval

Packing Interval defines how long the unit should wait before sending accumulated characters. This wait period is between successive network segments containing data. For alternate packing, the default interval is **12 ms**.

### Trailing Characters

In some applications, CRC, Checksum, or other trailing characters follow the end-of-sequence character; this option helps to adapt frame transmission to the frame boundary. The default setting is **00** (none).

### Send Characters

- ◆ If **2-Byte Send Character Sequence** is enabled, the unit interprets the sendchars as a 2-byte sequence; if this option is not enabled, the unit interprets them independently. The default setting is **0** (disabled).
- ◆ If **Send Immediately After Characters** is *not* set, any characters already in the serial buffer are included in the transmission after a "transmit" condition is found. If this option is set, the

unit sends immediately after recognizing the transmit condition (sendchar or timeout). The default setting is **0**.

**Note:** A transmission might occur if status information needs to be exchanged or an acknowledgment needs to be sent.

## DisConnTime (Inactivity Timeout)

Use this parameter to set an inactivity timeout. The unit drops the TCP connection to the local port if there is no activity on the serial line before the set time expires. Enter time in the format **mm:ss**, where **m** is the number of minutes and **s** is the number of seconds.

```
DisConnTime (00:00) ?:
```

To disable the inactivity timeout, enter **00:00**. Range is 0 (disabled) to 5999 seconds (99 minutes, 59 seconds). Default setting is **0**.

## Send Characters

Enter up to two characters in hexadecimal representation in sendchar.

```
SendChar 1 (00) ? _  
SendChar 2 (00) ? _
```

If the unit receives a character on the serial line that matches one of these characters, it sends the character immediately, along with any awaiting characters, to the TCP connection. This action minimizes the response time for specific protocol characters on the serial line (for example, ETX, EOT). Setting the first sendchar to **00** disables the recognition of the characters. Alternatively, the unit can interpret two characters as a sequence (see [Pack Control](#)). The default setting is **00**.

## Telnet Terminal Type

This parameter displays only if you enabled the terminal type option in Disconnect Mode. With this option enabled, you can use the terminal name for the Telnet terminal type. Enter only one name.

With terminal type option enabled, the unit also reacts to the EOR (end of record) and binary options, useful for applications like terminal emulation to IBM hosts.

## Channel (Port) Password

This parameter appears only if the channel (port) password option is enabled in Disconnect Mode. With this option enabled, you can set a password on the serial port. The default setting is all 0s.

## 9: Setup Mode: Advanced Settings

### Expert Settings (Option 5)

**Note:** You can change these settings using telnet or serial connections only, not on the Web Manager.

**Caution:** Changing the expert settings can drastically affect the performance and access to the product. These settings should only be changed by an experienced network administrator.

Select **5** to configure expert settings.

Figure 9-1 Expert Settings

```
TCP Keepalive time in s (1s - 65s; 0s=disable): (45) ?
ARP Cache timeout in s (1s - 600s) : (600) ?
CPU performance (0=Regular, 1=Low, 2=High): (0) ?
Disable Monitor Mode @ bootup (N) ?
HTTP Port Number : (80) ?
MTU Size (512 - 1400): (1400) ?
TCP Re-transmission Timeout (500 - 4000) (ms): (500) ?
Enable alternate MAC (N) ?
Ethernet connection type: (0) ?
```

#### TCP Keepalive Time In Seconds

This option allows you to change how many seconds the unit waits during a silent connection before attempting to see if the currently connected network device is still on the network. If the unit gets no response, it drops that connection. The default setting is 45.

```
TCP Keepalive time in s (1s - 65s; 0s=disable): (45) ?
```

#### ARP Cache Timeout In Seconds

Whenever the unit communicates with another device on the network, it adds an entry into its ARP table. The ARP Cache timeout option allows you to define how many seconds (1-600) the unit will wait before timing out this table. The default setting is **600**.

```
ARP cache timeout in s (1s - 600s) : (600) ?
```

#### CPU Performance

This option allows you to increase the CPU performance required to use the higher baud rates on the serial interface (460800 bps and 921600 bps). The default CPU performance mode supports up to 230400 bps.

```
CPU performance (0=Regular, 1=Low, 2=High): (0) ?
```

- ◆ If a baud rate of 460 Kbps or 920 Kbps is set and the high performance mode is disabled, the operation of the serial channel would be out of the specified error tolerance, thereby leading to inconsistent speed settings on the two ends of the serial channel.

- ◆ Increasing CPU clock speed consumes more power and generates more heat. This reduces the maximum operating temperature specification. See the appropriate product brief for details.

### Monitor Mode at Bootup

This option allows you to disable all entries into Monitor Mode during startup, except for the 'xxx' sequence. This prevents entry using **yyy**, **zzz**, **xx1**, and **yy1** key sequences (only during the bootup sequence). The default for disabling Monitor Mode at bootup is **N** (No). See [Chapter 11: Monitor Mode](#).

Disable Monitor Mode @ bootup (N) ?

### HTTP Port Number

This option allows the configuration of the web server port number. The valid range is **1-65535**. The default HTTP port number is **80**.

HTTP Port Number : (80) ?

### MTU Size

The Maximum Transmission Unit (MTU) is the largest physical packet size a network can transmit for TCP and UDP. Enter between **512** and **1400** bytes. The default setting is **1400** bytes.

MTU Size (512 - 1400): (1400) ?

### TCP Re-Transmission Timeout

This feature allows the configuration of the desired TCP re-transmission timeout value. If the ACK is not received for a packet sent from the xDirect device, then the unit will retransmit the data. The valid range is 500-4000 msec. Default is 500.

TCP Re-transmission Timeout (500 - 4000) (ms): (500) ?

### Enable Alternate MAC

If necessary, enable the alternate MAC address (if specified in the OEM setup record). The default setting is **N** (No).

Enable alternate MAC (N) ?

### Ethernet Connection Type

The xDirect allows for the Ethernet speed and duplex to be manually configured. Enter **0** for auto-negotiation (default). To select the speed and duplex, enter one of the following: **2** (10Mbit/half duplex), **3** (10Mbit/full duplex), **4** (100Mbit/half duplex), or **5** (100Mbit/full duplex).

Ethernet connection type: (0) ?

## Security Settings (Option 6)

You can change security settings by means of Telnet or serial connections only, not on the Web Manager. We recommend that you set security over the dedicated network or over the serial setup to prevent eavesdropping.



**Caution:** *Disabling both Telnet Setup and Port 77FE will prevent users from accessing the setup menu from the network. Disabling Port 77FE also disables the Web from configuring the device.*

Select **6** to configure security settings.

**Figure 9-2 Security Settings**

```

Disable SNMP (N) ?
SNMP Community Name (public):
Disable Telnet Setup (N) ?
Disable TFTP Firmware Update (N) ?
Disable Port 77FEh (N) ?
Disable Web Server (N) ?
Disable Web Setup (N) ?
Disable ECHO ports (Y) ?
Enable Encryption (N) ?
Enable Enhanced Password (N) ?

```

### Disable SNMP

This setting allows you to disable the SNMP protocol on the unit for security reasons. The default setting is **N** (No).

```
Disable SNMP (N) ? _
```

### SNMP Community Name

The SNMP Community Name is a required field for NMS to read or write to a device. Enter a string of **1** to **13** characters. The default setting is **public**.

```
SNMP Community Name (public): _
```

The default entry is public. The current value is displayed in parentheses.

### Disable Telnet Setup

**Note:** *If you choose to disable this option, keep in mind that disabling both Telnet Setup and Port 77FE will prevent users from accessing the setup menu from the network.*

This setting defaults to the **N** (No) option. The **Y** (Yes) option disables access to Setup Mode by Telnet (port 9999). It only allows access locally using the web pages and the serial port of the unit.

```
Disable Telnet Setup (N) ? _
```

### Disable TFTP Firmware Update

This setting defaults to the **N** (No) option. The **Y** (Yes) option disables the use of TFTP to perform network firmware upgrades. With this option, you can download firmware upgrades over the serial port using DeviceInstaller's Recover Firmware procedure. See [Chapter 10: Firmware Upgrades](#).

Disable TFTP Firmware Update (N) : \_

### Disable Port 77FE (Hex)

**Note:** If you choose to disable this option, keep in mind that disabling both Telnet Setup and Port 77FE will prevent users from accessing the setup menu from the network.

Port 77FE is a setting that allows DeviceInstaller, Web Manager, and custom programs to configure the unit remotely. You may wish to disable this capability for security purposes.

Disable Port 77FEh (N) ? \_

The default setting is the **N** (No) option, which enables remote configuration. You can configure the unit by using DeviceInstaller, web pages, Telnet, or serial configuration.

The **Y** (Yes) option disables remote configuration and web sites.

### Disable Web Server

This setting defaults to the **N** (No) option. The **Y** (Yes) option disables the web server.

Disable Web Server (N) ? \_

### Disable Web Setup

The **Y** (Yes) option disables configuration using the Web Manager. This setting defaults to the **N** (No) option.

Disable Web Setup (N) ? \_

### Disable ECHO Ports

This setting controls whether port 7 echoes characters it receives. The default setting is **Y** (Yes), which disables ECHO ports.

Disable ECHO ports (Y) ? \_

### Enable Encryption

Rijndael is the block cipher algorithm chosen by the National Institute of Science and Technology (NIST) as the Advanced Encryption Standard (AES) to be used by the US government. The xDirect supports 128-, 192-, and 256-bit encryption key lengths.

**Note:** Configuring encryption should be done through a local connection to the serial port of the xDirect, or via a secured network connection. Initial configuration information, including the encryption key, is sent in clear text over the network.

#### To configure AES encryption on the xDirect:

Enable Encryption (N) Y

Key length in bits (0): 128

Change Keys (N) Y

Enter Keys:   \*\*-\*

1. When prompted to enable encryption, select **Y**.
2. When prompted, enter the encryption key length. The xDirect supports 128-, 192-, and 256-bit encryption key lengths.
3. When prompted to change keys, select **Y**.
4. At the **Enter Keys** prompt, enter your encryption key. The encryption keys are entered in hexadecimal. The hexadecimal values are echoed as asterisks to prevent onlookers from seeing the key. Hexadecimal values are 0-9 and A-F.
  - ◆ For a 128-bit key length, enter 32 hexadecimal characters.
  - ◆ For a 192-bit key length, enter 48 hexadecimal characters.
  - ◆ For a 256-bit key length, enter 64 hexadecimal characters
5. Continue pressing **Enter** until you return to the Change Setup menu.
6. From the Change Setup menu, select option **9** to save and exit.

Encryption only applies to the port selected for data tunneling (default 10001), regardless of whether you are using TCP or UDP.

Generally, one of these situations applies:

- ◆ Encrypted xDirect-to-xDirect communication. Be sure to configure both xDirect devices with the same encryption key.
- ◆ Third-party application to xDirect-encrypted communication: xDirect uses standard AES encryption protocols. To communicate successfully, products and applications on the peer side must use the same protocols and the same encryption key as the xDirect.
- ◆ Lantronix Secure Com Port Redirector provides an encrypted connection from Windows-based applications to the xDirect. Information about SCPR is at [www.lantronix.com/device-networking/utilities-tools/scpr](http://www.lantronix.com/device-networking/utilities-tools/scpr). A 30-day trial version of SCPR is available.

**Note:** Developers can license the Lantronix Encryption Library Suite. See [www.lantronix.com/device-networking/utilities-tools](http://www.lantronix.com/device-networking/utilities-tools).

### Enable Enhanced Password

This setting defaults to the **N** (No) option, which allows you to set a 4-character password that protects Setup Mode by means of Telnet and web pages. The **Y** (Yes) option allows you to set an extended security password of 16-characters for protecting Telnet and Web Page access.

Enable Enhanced Password (N) ? \_

## Default Settings (Option 7)

Select **7** to reset the unit's Channel 1 configuration and expert settings to the default settings. The server configuration settings for IP address, gateway IP address, and netmask remain unchanged. The specific settings that this option changes are listed below:

## Channel 1 Configuration Defaults

<b>Baudrate</b>	9600
<b>I/F Mode</b>	4C (1 stop bit, no parity, 8 bit, RS-232C)
<b>Flow</b>	00
<b>TCP port number</b>	10001
<b>Connect Mode</b>	C0 (always accept incoming connection; no active connection startup)
<b>Send '+++' in Modem Modem</b>	Enabled
<b>Show IP addr after 'RING'</b>	Enabled
<b>Auto increment source port</b>	Disabled
<b>Hostlist retry counter</b>	3
<b>Hostlist retry timeout</b>	250 (msec)
<b>Start Character</b>	0x0D (CR)
<b>All other parameters</b>	0

## Expert Settings Defaults

<b>TCP Keepalive time in s</b>	45
<b>ARP Cache timeout in s</b>	600
<b>CPU Performance</b>	0 (Regular)
<b>Disable Monitor Mode @ bootup</b>	No
<b>HTTP Port Number (1-65535)</b>	80
<b>MTU Size (512 – 1400)</b>	1400
<b>TCP Re-transmission Timeout (500-4000)</b>	500 (ms)
<b>Alternate MAC</b>	Disabled ( for OEM use only)
<b>Ethernet Connection Type</b>	0 (auto-negotiate)

## Security Settings Defaults

<b>Disable SNMP</b>	No
<b>SNMP community name</b>	public
<b>Disable Telnet setup</b>	No
<b>Disable TFTP Firmware Update</b>	No
<b>Disable Port 77FEh</b>	No
<b>Disable Web Server</b>	No
<b>Disable Web Setup</b>	No
<b>Disable ECHO ports</b>	Yes
<b>Enable Enhanced Password</b>	No

# 10: Firmware Upgrades

## Obtaining Firmware

You can obtain the most up-to-date firmware and release notes for the unit from the Lantronix web site ([www.lantronix.com/support/downloads](http://www.lantronix.com/support/downloads)) or by using anonymous FTP ([ftp.lantronix.com/pub](ftp://lantronix.com/pub)).

## Reloading Firmware

There are several ways to update the unit's internal operational code (\*.ROM): using DeviceInstaller (the preferred way), using TFTP, or using the serial port. You can also update the unit's internal Web interface (\*.COB) using TFTP or DeviceInstaller.

Here are *typical* names for those files. Check the Lantronix web site for the latest versions and release notes.

**Table 10-1 Firmware Files**

ROM File	COB
xdirect_6900.rom	xdirect_webm_2000.cob

Please refer to the DeviceInstaller online Help for information about reloading firmware using DeviceInstaller. The other methods are discussed below.

### Using TFTP: Graphical User Interface

#### To download new firmware from a computer:

1. Use a TFTP client to send a binary file to the unit (\*.ROM to upgrade the unit's internal operational code and \*.COB to upgrade its internal Web interface).

**Note:** TFTP requires the .ROM (binary) version of the unit's internal operational code.

2. In the **TFTP server** field, enter the IP address of the unit being upgraded.
3. Select **Upload** operation and **Binary** format.
4. Enter the full path of the firmware file in the **Local file name** field.
5. In the **Remote file name** field, enter the current internal operational code (**U5**) or **WEB1** to **WEB6** for the internal Web interface.
6. Click the **Upload Now** button to transfer the file to the unit.

Figure 10-2 TFTP Window

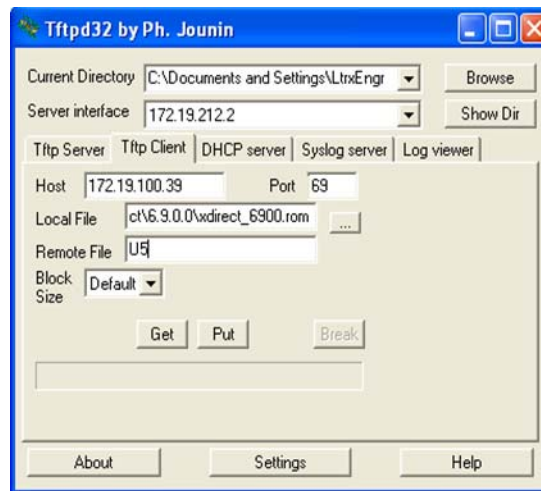

After the firmware has been loaded and stored, which takes approximately 8 seconds to complete, the unit performs a power reset.

### Using TFTP: Command Line Interface

**To download new firmware from a computer:**

1. Enter the following from a TFTP command line interface:

```
tftp -i <ip address> put <local filename> <destination file name>
```

The following examples demonstrate the TFTP command sequence to download the .rom file and the .cob file:

```
tftp -i 192.168.1.111 put xdirect_6900.rom U5
tftp -i 192.168.1.111 put xdirect_webm_2000.cob WEB1
```

### Recovering the Firmware Using the Serial Port and DeviceInstaller

If for some reason the firmware is damaged, you can recover the firmware file by using DeviceInstaller to download the \*.ROM file over the serial port.

**To recover firmware:**

1. Start DeviceInstaller. If your PC has more than one network adapter, a message displays. Select an adapter and click **OK**.
2. From the **Tools** menu, select **Advanced/Recover Firmware**. The Serial Port Firmware Upgrade window displays.
3. For **Port on PC**, enter the COM port on the PC that is connected to the serial port of the Lantronix unit.
4. For **Device Model**, be sure the appropriate device (e.g., xDirect) displays.
5. For **Firmware File**, click the **Browse** button and go to the location where the firmware file resides.

**Note:** Make sure the xDirect on which you are recovering firmware is connected to this selected port on your PC.

6. Click **OK** to download the file.
7. When prompted, reset the device. Status messages and a progress bar at the bottom of the screen show the progress of the file transfer. When the file transfer completes, the message "**Successful, Click OK to Close**" displays.
8. Click the **OK** button to complete this procedure.

**Note:** For more information, see *Recovering Firmware in the DeviceInstaller online Help*.

## 11: Monitor Mode

Monitor Mode is a command-line interface used for diagnostic purposes. There are two ways to enter Monitor Mode: locally using the serial port or remotely using the network.

### Entering Monitor Mode Using the Serial Port

**To enter Monitor Mode locally:**

1. Follow the same steps used for setting the serial configuration parameters.
2. Instead of typing three **x** keys, however:
  - ◆ Type **zzz** (or **xx1**) to enter Monitor Mode with network connections.
  - ◆ Type **yyy** (or **yy1**) to enter Monitor Mode without network connections.

A **0>** prompt indicates that you have successfully entered Monitor Mode.

### Entering Monitor Mode Using the Network Port

**To enter Monitor Mode using a Telnet connection:**

1. From the Windows **Start** menu, click **Run** and type the following command, where **x.x.x.x** is the IP address, and **9999** is the unit's fixed network configuration port number:

Windows: `telnet x.x.x.x 9999`

UNIX: `telnet x.x.x.x:9999`

2. Click **OK**. The following information and login prompts display (see [Figure 11-1](#)).

**Figure 11-1 MAC Address and Login Prompt**

```
*** Lantronix xDirect 232 Device Server ***
MAC address 00204A9D028B
Software version V6.9.0.0RC3 (120828) XDIRECT
AES library version 1.8.2.1
User Name :admin
Password  :----
Press Enter for Setup Mode
```

3. Enter **User Name** (user name is **admin** and cannot be changed). Pressing the **Enter** key after entry is not necessary. The **Password** field will appear.
4. Enter **Password** (default password is **PASS**). Pressing the **Enter** key after entry is not necessary. You will be prompted to enter Setup Mode.

**Note:** Password can be modified or disabled. See [Server Configuration \(on page 26\)](#).

5. Type **M** (upper case) immediately.

A **0>** prompt indicates that you have successfully entered Monitor Mode.



## Monitor Mode Commands

The following commands are available in Monitor Mode. Many commands have an IP address as an optional parameter (xxx.xxx.xxx.xxx). If you enter the IP address, the command is applied to another unit with that IP address. If you do not enter the IP address, the command is executed locally.

**Note:** All commands must be in capital letters. Responses to some of the commands are in Intel Hex format.

**Table 11-2 Monitor Mode Commands**

Command	Command Name	Function
<b>VS x.x.x.x</b>	Version	Queries software header record (16 bytes) of unit with IP address x.x.x.x.
<b>GC x.x.x.x</b>	Get Configuration	Gets configuration of unit with IP address x.x.x.x as hex records (120 bytes).
<b>SC x.x.x.x</b>	Send Configuration	Sets configuration of unit with IP address x.x.x.x from hex records.
<b>PI x.x.x.x</b>	Ping	Pings unit with IP address x.x.x.x to check device status.
<b>AT</b>	ARP Table	Shows the unit's ARP table entries.
<b>TT</b>	TCP Connection Table	Shows all incoming and outgoing TCP connections.
<b>NC</b>	Network Connection	Shows the unit's current IP address, gateway, subnet mask, and DNS server.
<b>RS</b>	Reset	Resets the unit's power.
<b>QU</b>	Quit	Exits diagnostics mode.
<b>G0, G1, ...,Ge, Gf</b>	Get configuration from memory page	Gets a memory page of configuration information from the device.
<b>S0, S1, ...,Se, Sf</b>	Set configuration to memory page	Sets a memory page of configuration information on the device.
<b>GM</b>	Get MAC address	Shows the unit's 6-byte MAC address.
<b>SS</b>	Set Security record	Sets the Security record without the encryption key and length parameters. The entire record must still be written, but the encryption-specific bytes do not need to be provided (they can be null since they are not overwritten).
<b>SA</b>	Scan	Initiates a wireless scan if the wireless interface is enabled. Reports any stations found, including BSSID, SSID, and RSSI. If SA is followed by a string, the string is used to filter SSIDs before reporting. If the BSS does not broadcast its SSID, only the BSSID and RSSI are returned.
<b>NS</b>	Network Status	Reports the network interfaces' statuses. Includes potentially negotiated parameters like speed/duplex for Ethernet or BSSID, encryption, authentication for wireless interfaces.

Command (continued)	Command Name	Function
<b>co</b>	Set IP address, host bits, gateway, and DNS server IP	<p>Example:</p> <pre>co 192.168.0.10 8 192.168.0.1 10001 192.168.1.10</pre> <p>with</p> <ul style="list-style-type: none"> <li>192.168.0.10 = IP address of the xDirect</li> <li>8 = number of host bits</li> <li>192.168.0.1 = gateway IP address</li> <li>10001 = port number of the xDirect</li> <li>192.168.1.10 = IP address of the DNS Server</li> </ul> <p>The xDirect stores the setup and performs a reset. It sends an <b>X</b> before the reset if the command was OK.</p>

**Note:** Entering any of the commands listed above generates one of the following command response codes:

**Table 11-3 Command Response Codes**

Response	Meaning
<b>0&gt;</b>	OK; no error
<b>1&gt;</b>	No answer from remote device
<b>2&gt;</b>	Cannot reach remote device or no answer
<b>8&gt;</b>	Wrong parameter(s)
<b>9&gt;</b>	Invalid command

## Appendix A: Troubleshooting and Contact Info

This chapter discusses how you can diagnose and fix errors quickly without having to contact a dealer or Lantronix. It helps to connect a terminal to the serial port while diagnosing an error to view summary messages that may display. When troubleshooting, always ensure that the physical connections (power cable, network cable, and serial cable) are secure.

**Note:** Some unexplained errors might be caused by duplicate IP addresses on the network. Make sure that your unit's IP address is unique.

When troubleshooting the following problems, make sure that the xDirect is powered up. Confirm that you are using a good network connection.

### LEDs

xDirect has the following LEDs, which help indicate and monitor device activity.

- ◆ "X" Power/Status
- ◆ Ethernet Link
- ◆ Ethernet Data Activity
- ◆ Serial RX Data Activity
- ◆ Serial TX Data Activity

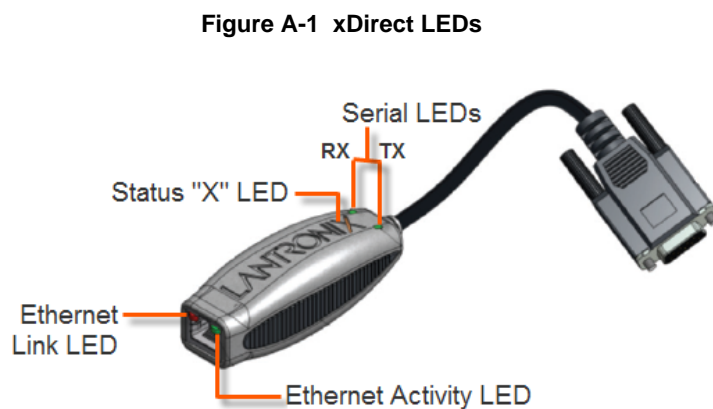

### Status LED

The "X" Power/Status LED located on the top of the xDirect unit displays multiple blink patterns. The following table explains the Status LED functions based on the number of LED blinks between pauses:

**Table A-2 Status LED**

Status LED	Condition
OFF	No power.
Blinks 3 times every 4 seconds	Duplicate IP address present on network.
Blinks 5 times every 4 seconds	No DHCP address obtained.
Blinks 2 times every second	Setup menu active.
Blinks 1 time every second	Socket connection to the serial channel.

## Serial LEDs

Two serial LEDs on top of the xDirect unit, directly adjacent to the "X" Power/Status LED, indicate transmit and receive data activity:

**Table A-3 Serial LEDs**

Serial LED	Color	Condition
TX Serial LED	Green	Indicates transmit data activity.
RX Serial LED	Amber	Indicates receive data activity.

## RJ45 Ethernet LED

The following two tables describe the meaning of the left and right LED colors on the Ethernet.

**Table A-4 Ethernet Link LED**

Color	Meaning
Off	No Link
Amber	10 Mbps
Green	100 Mbps

**Table A-5 Ethernet Activity LED**

Color	Meaning
Off	No Activity
Amber	Half Duplex
Green	Full Duplex

## Problems and Error Messages

**Table A-6 Problems and Error Messages**

Problem/Message	Reason	Solution
When you issue the <b>ARP -S</b> command in Windows, the "ARP entry addition failed: 5" message displays. For Windows Vista/7 you need to run DOS as administrator regardless of your login.	Your currently logged-in user does not have the correct rights to use this command on this PC. Windows Vista/7 has changed security measures.	Have someone from your IT department log you in with sufficient rights. To configure Windows Vista/7 use the link below for FAQ 1442. <a href="http://ltxfaq.custhelp.com/app/answers/list">http://ltxfaq.custhelp.com/app/answers/list</a> Enter 1442 in the keyword search field to retrieve the FAQ 1442 instructions.
When you attempt to assign an IP address to the unit by the ARP method, the "Press Enter to go into Setup Mode" error "(described below) message displays. Now when you Telnet to the device server, the connection fails.	When you Telnet to port 1 on the device server, you are only assigning a temporary IP address. When you Telnet into port 9999 and do not press <b>Enter</b> quickly, the device server may have rebooted, causing it to lose the IP address.	Telnet back to Port 1. Wait for it to fail, then Telnet to port 9999 again. Make sure you press <b>Enter</b> quickly.

Problem/Message (continued)	Reason	Solution
When you Telnet to port 9999, the "Press Enter to go into Setup Mode" message displays. However, nothing happens when you press <b>Enter</b> , or your connection is closed.	You did not press <b>Enter</b> quickly enough. You only have 5 seconds to press <b>Enter</b> before the connection is closed.	Telnet to port 9999 again, but press <b>Enter</b> as soon as you see the "Press Enter to go into Setup Mode" message.
When you Telnet to port 1 to assign an IP address to the device server, the Telnet window does not respond for a long time.  For an audio/video instruction segment about assigning an IP using ARP go to: <a href="http://ltxfqa.custhelp.com/app/answers/list">http://ltxfqa.custhelp.com/app/answers/list</a>  Enter 1119 in the keyword search field to retrieve the FAQ 1119 for instructions. Look for the tutorial that is titled "Assigning an IP address using ARP" under the CoBos tutorials.	You may have entered the Ethernet address incorrectly with the ARP command.  The IP address you are trying to assign is not on your local subnet.  The device server may not be plugged into the network properly.	Confirm that the Ethernet address that you entered with the ARP command is correct. The Ethernet address may only include numbers 0-9 and letters A-F. In Windows and usually in Unix, the segments of the Ethernet address are separated by dashes. In some forms of Unix, the Ethernet address is segmented with colons.  Confirm that your PC has an IP address and that it is in the same local subnet that you are trying to assign to the device server.  Make sure that the Link LED is lit. If the Link LED is not lit, then the device server is not properly plugged into the network.
When you try to assign an IP with DeviceInstaller, you get the following:  "No response from device! Verify the IP, Hardware Address and Network Class. Please try again."	The cause is most likely one of the following: <ul style="list-style-type: none"><li>◆ The hardware address you specified is incorrect.</li><li>◆ The IP address you are trying to assign is not a valid IP for your logical subnet.</li><li>◆ You did not choose the correct subnet mask.</li></ul>	Double-check the parameters that you specified.  <b>Note:</b> You cannot assign an IP address to a device server through a router. See <a href="#">Chapter 4: Using DeviceInstaller</a> .
The device server is not communicating with the serial device to which it is attached.	The most likely reason is the wrong serial settings were chosen.	The serial settings for the serial device and the device server must match. The default serial settings for the device server are RS-232, 9600 baud, 8 character bits, no parity, 1 stop bit, no flow control. Reference <a href="#">Serial Settings (on page 29)</a> or <a href="http://ltxfqa.custhelp.com/app/answers/list">http://ltxfqa.custhelp.com/app/answers/list</a> .  Enter 1119 in the keyword search field to retrieve the FAQ 1119 for instructions. Look for the tutorial that is titled "Assigning an IP address using Device Installer" under the CoBos tutorials.

Problem/Message (continued)	Reason	Solution
<p>When you try to enter the setup mode on the device server using the serial port, you get no response.</p>	<p>The issue is most likely something covered in the previous problem, or possibly, you have <b>Caps Lock</b> on.</p>	<p>Double-check everything in the problem above. Confirm that <b>Caps Lock</b> is not on. Reference <a href="http://ltxfaq.custhelp.com/app/answers/list">Serial Settings (on page 29)</a> or <a href="http://ltxfaq.custhelp.com/app/answers/list">http://ltxfaq.custhelp.com/app/answers/list</a>.</p> <p>Enter 1119 in the keyword search field to retrieve the FAQ 1119 for instructions. Look for the tutorial that is titled "Assigning an IP address using serial" under the CoBos tutorials.</p>
<p>You can ping the device server, but not Telnet to the device server on port 9999.</p>	<p>There may be an IP address conflict on your network</p> <p>You are not Telneting to port 9999.</p> <p>The Telnet configuration port (9999) is disabled within the device server security settings.</p>	<p>Turn the device server off and then issue the following commands at the DOS prompt of your computer:</p> <p>ARP -D X.X.X.X (X.X.X.X is the IP of the device server).</p> <p>PING X.X.X.X (X.X.X.X is the IP of the device server).</p> <p>If you get a response, then there is a duplicate IP address on the network. If you do not get a response, use the serial port to verify that Telnet is not disabled.</p>
<p>With DeviceInstaller, you get the <i>Wrong Password</i> error when you try to upgrade the firmware.</p>	<p>The file you are attempting to load is the incorrect firmware file for the XDIRECT.</p>	<p>Download the correct firmware file from the Lantronix website.</p>
<p>The device server appears to be set up correctly, but you are not communicating with your device attached to the device server across the network.</p>	<p>If you are sure that the serial port settings are correct, then you may not be connecting to the correct socket of the device server.</p> <p>Another possibility is that the device server is not set up correctly to make a good socket connection to the network.</p>	<p>You can check to see whether there is a socket connection to or from the XDIRECT by looking at the Status LED.</p> <p>If the Status LED is blinking consistently, then there is a good socket connection.</p> <p>If the Status LED is solid, then the socket connection does not exist. Use the Connect Mode option <b>C0</b> for making a connection to the XDIRECT from the network. Use Connect Mode option <b>C1</b> or <b>C5</b> for a connection to the network from the XDIRECT.</p>
<p>When connecting to the Web-Manager within the device server, the "No Connection With The Device Server" message displays.</p>	<p>Your computer is not able to connect to port 30718 (77FEh) on the device server.</p>	<p>Make sure that port 30718 (77FEh) is not blocked with any router that you are using on the network. Also, make sure that port 77FEh is not disabled within the Security settings of the device server.</p>

## Technical Support

### United States

Phone: (800) 422-7044

Please check our online knowledge base or send a question to Technical Support at <http://www.lantronix.com/support>.

### Europe, Middle East and Africa

Phone: (33) 13-930-4172

Email: [eu\\_techsupp@lantronix.com](mailto:eu_techsupp@lantronix.com) or [eu\\_support@lantronix.com](mailto:eu_support@lantronix.com)

Firmware downloads, FAQs, and the most up-to-date documentation are available at <http://www.lantronix.com/support>

When you report a problem, please provide the following information:

- ◆ Your name, and your company name, address, and phone number
- ◆ Lantronix model number
- ◆ Lantronix serial number/MAC address
- ◆ Firmware version (on the first screen shown when you Telnet to the device)
- ◆ Description of the problem
- ◆ Status of the unit when the problem occurred (please try to include information on user and network activity at the time of the problem)

## Appendix B: Connections and Pinouts

The xDirect has a DB9F DCE connector, and an Ethernet 10/100 RJ45 interface. The xDirect can be powered via a mini USB-B jack with a provided 5 VDC power supply, or Ethernet PoE (hardware optional), or DB9F pin 9 and 5.

Figure B-1 Single Serial Port and Ethernet Port on xDirect



### Serial Port Pinouts

The xDirect has one female DB9 DCE serial port that supports one of three pinouts depending on the model of your xDirect unit:

Figure B-2 DB9F in RS232 Mode (All Models)

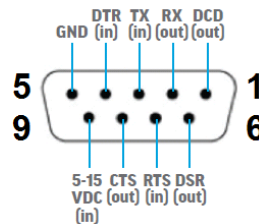

Figure B-3 DB9F in RS422/485 (4-Wire) Mode (xDirect485 & PoE Models)

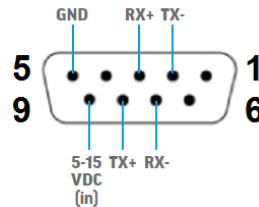
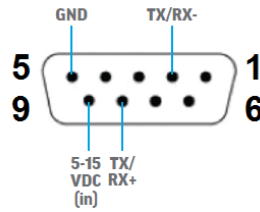



Figure B-4 DB9F in RS485 (2-Wire) Mode (xDirect485 & PoE Models)



## Ethernet Connector Pinouts

The xDirect supports 10/100 Mbps half or full duplex Ethernet through an RJ45 connector. For PoE option, the xDirect is compliant as an IEEE 802.3af Power Device, Class . Power connections can be established via data pins (1 & 2 and 3 & 6), or spare pins (4 & 5 and 7 & 8).

Figure B-5 RJ45 Ethernet Connector

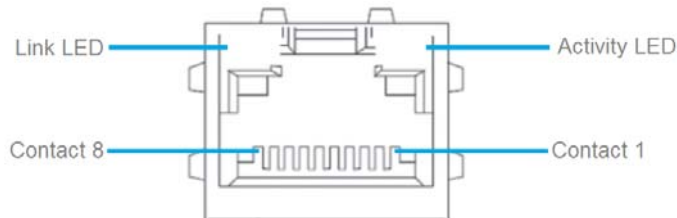

Table B-6 Ethernet RJ45 Connector Pin-Outs

Pin	Ethernet Data	PoE Alternate A (data pins)	PoE Alternate B (data pins)	PoE Alternate C (spare pins)	PoE Alternate D (spare pins)
1	TX+ (out)	VDC+	VDC-		
2	TX- (out)	VDC+	VDC-		
3	RX+ (in)	VDC-	VDC+		
4				VDC+	VDC-
5				VDC+	VDC-
6	RX- (in)	VDC-	VDC+		
7				VDC-	VDC+
8				VDC-	VDC+

**Note:** The Ethernet connector pin-out above is provided only for reference during installation and troubleshooting. xDirect is not HP Auto-MDIX compatible (i.e. not straight/cross cable interchangeable). When utilizing PoE to power the xDirect (for PoE model only), use an Ethernet hub/switch or PoE injector that is IEEE 802.3af compliant.

## Power Jack (Mini USB-B)

The 5 VDC power supply included with standard xDirect devices (and not included the xDirect PoE model) connects to standard xDirect units through a mini USB connector on the side of the device.

**Figure B-7 Mini USB Power Port Connector on Standard xDirect Units**



## Appendix C: Technical Specifications

**Table C-1 xDirect Technical Specifications**

Category	Description
<b>CONTROLLER</b>	
CPU	Lantronix DSTni-EX enhanced 16-bit x86 architecture, 48 MHz clock
<b>MEMORY</b>	
Internal CPU Memory	256 KB zero wait state SRAM
Flash	8 Mbits (1 MB)
<b>POWER INPUT<sup>1,2</sup></b>	
1 Mini USB-B jack	<ul style="list-style-type: none"> <li>◆ Accepts 5 VDC Wall Adapter (included in non-PoE models)</li> <li>◆ Pin 1 (+) and pin 4, 5 (-)</li> <li>◆ Data pins = no connection</li> </ul> <p><i>Note: User can also use USB powering from a PC as long as the USB source is able to provide 5V 500mA with no requirement for power negotiation</i></p>
1 DB9F Redundant Powering	<ul style="list-style-type: none"> <li>◆ 5 to 15 VDC</li> <li>◆ Pin 9 (+) and pin 5 (-)</li> </ul> <p><i>Note: If using a null modem gender (Lantronix P/N 140-448-R), Pin 9 can be used to power the unit.</i></p>
Optional PoE Redundant Powering via Ethernet RJ45 Connector (PoE version only)	<ul style="list-style-type: none"> <li>◆ IEEE 802.3af PoE standard-compliant PD</li> <li>◆ Powering via data pins or spare pins</li> <li>◆ Magnetic Isolation 1500 VAC between Ethernet connection and internal logic</li> </ul> <p><i>Note: See ordering part number for PoE option on Lantronix website</i></p>
LED Indicator (amber "X")	Power/Status
Power Rating	<ul style="list-style-type: none"> <li>◆ 1.3W max with no PoE</li> <li>◆ 2.0W max with PoE option</li> </ul>
<b>SERIAL INTERFACE</b>	
1 DB9F Connector	<ul style="list-style-type: none"> <li>◆ DCE serial port</li> <li>◆ Software-selectable baud rate from 300 to 921 Kbaud</li> <li>◆ Software-selectable RS232, RS422 or RS485 (2 and 4 wire support)</li> <li>◆ Redundant powering from pin 9 (+) and pin 5 (-), 5V to 15 VDC</li> <li>◆ 15kV HBM ESD protection on RS232 and RS422/485 transceivers</li> </ul>
Serial Line Formats	<ul style="list-style-type: none"> <li>◆ Characters: 7 or 8 data bits</li> <li>◆ Stop bits: 1 or 2</li> <li>◆ Parity: odd, even, none</li> </ul>
Modem Control	DTR, DSR
Flow Control	<ul style="list-style-type: none"> <li>◆ Hardware: CTS/RTS</li> <li>◆ Software: XON/XOFF</li> </ul>
LEDs for Serial Data	<p>Transmit and Receive Activities:</p> <ul style="list-style-type: none"> <li>◆ Green: indicates transmission activity</li> <li>◆ Amber: indicates reception activity</li> </ul>

Category (continued)	Description
<b>NETWORK INTERFACE</b>	
1 RJ45 Connector	<ul style="list-style-type: none"> <li>◆ 10Base-T/100Base-TX Ethernet port</li> <li>◆ Software selectable Ethernet speed 10/100/Auto</li> <li>◆ Software selectable Half/Full/Auto duplex</li> <li>◆ 15 KV ESD protection by TVS diodes</li> </ul>
Ethernet LEDs	<ul style="list-style-type: none"> <li>◆ 10/100 Mbit Link (green/amber)</li> <li>◆ 10/100 Activity (green/amber)</li> </ul>
Magnetic Isolation	1500 VAC between Ethernet connection and internal logic
<b>WEIGHT</b>	0.068 kg (0.15 lbs)
<b>ENVIRONMENTAL</b>	
Operating Temperature <sup>3</sup>	-40° to +85°C for non-PoE models UL certified -40° to +75°C
Storage Temperature	-40° to +85°C
Relative Humidity	0 to 90% non-condensing

1. Connect Power Input only to IEC Class III or NEC Class 2 Circuits. Connect POE only to IEEE 802.3 series Standard (Ethernet).
2. In the case of more than one power sources are plugged in for power redundancy (e.g. PoE and DB9F pins, or mini USB-B and DB9F pins, or PoE and DB9F pins), unit's power usage is likely provided between sources. Also, note that this redundancy configuration does not guarantee an uninterrupted operation at the moment when one source goes out of service.
3. Lantronix power supply shipped with xDirect is UL certified 0° to +40°C operating only, thus, users are cautioned when using with xDirect in environments outside of this temperature range. Users can:
  - a) use both the xDirect and the power supply at 0° to +40°C, or
  - b) place the power supply in the environment temperature 0° to +40°C, and run the output cord to xDirect which could be placed in its own environment operating -40° to +75°C, or
  - c) use a power supply that has similar rated temperature to that of xDirect so that the power supply and xDirect can be placed in the same environment.

## Appendix D: Alternative Ways to Assign an IP Address

Earlier chapters describe how to assign a static IP address using DeviceInstaller, Web Manager, and Setup Mode (through a Telnet or serial connection). This section covers other methods for assigning an IP address over the network.

### DHCP

The unit ships with a default IP address of 0.0.0.0, which automatically enables DHCP. If a DHCP server exists on the network, it provides the unit with an IP address, gateway address, and subnet mask when the unit boots up.

You can use the DeviceInstaller software to search the network for the DHCP-assigned IP address and add it to the list of devices retrieved.

**Note:** This DHCP address does **not** appear in the unit's Setup Mode or in Web Manager. You can determine your unit's DHCP-assigned IP address in Monitor Mode. When you enter Monitor Mode from the serial port with network connection enabled and issue the **NC** (Network Communication) command, you see the unit's IP configuration.

### AutoIP

The unit ships with a default IP address of 0.0.0.0, which automatically enables Auto IP within the unit. AutoIP is an alternative to DHCP that allows hosts to obtain an IP address automatically in smaller networks that may not have a DHCP server. A range of IP addresses (from 169.254.0.1 to 169.254.255.1) has been explicitly reserved for AutoIP-enabled devices. Do not use this range of Auto IP addresses over the Internet.

- ◆ If your unit cannot find a DHCP server, and you have not manually assigned an IP address to it, the unit automatically selects an address from the AutoIP reserved range. Then, your unit sends out a (ARP) request to other nodes on the same network to see whether the selected address is being used.
- ◆ If the selected address is not in use, then the unit uses it for local subnet communication.
- ◆ If another device is using the selected IP address, the unit selects another address from the AutoIP range and reboots. After reboot, the unit sends out another ARP request to see if the selected address is in use, and so on.

AutoIP does not replace DHCP. The unit continues to look for a DHCP server on the network. If it finds a DHCP server, the unit switches to the DHCP server-provided address and reboots.

**Note:** If a DHCP server is found, but it denies the request for an IP address, the unit does not attach to the network, but waits and retries.

AutoIP can be disabled by setting the unit's IP address to 0.0.1.0. This setting enables DHCP but disables AutoIP.

## BOOTP

Similar to DHCP, but for smaller networks. Automatically assigns the IP address for a specific duration of time.

## ARP and Telnet

If the unit has no IP address, you can use Address Resolution Protocol (ARP) method from UNIX and Windows-based systems to assign a temporary IP address.

### To assign a temporary IP address:

1. On a UNIX or Windows-based host, create an entry in the host's ARP table using the intended IP address and the hardware address of the unit (on the product label on the bottom of the unit).

```
arp -s 191.12.3.77 00:20:4a:xx:xx:xx (Unix)
```

```
arp -s 191.12.3.77 00-20-4a-xx-xx-xx (Windows)
```

**Note:** For the ARP command to work on Windows 95, the ARP table on the PC must have at least one IP address defined other than its own.

2. If you are using Windows 95, type `ARP -A` at the DOS command prompt to verify that there is at least one entry in the ARP table. If the local machine is the only entry, ping another IP address on your network to build a new entry in the ARP table; the IP address must be a host other than the machine on which you are working. Once there is at least one additional entry in the ARP table, use the following command to ARP an IP address to the unit:

```
arp -s 191.12.3.77 00-20-4a-xx-xx-xx
```

3. Open a Telnet connection to port 1. The connection fails quickly, but the unit temporarily changes its IP address to the one designated in this step.

```
telnet 191.12.3.77 1
```

4. Open a Telnet connection to port 9999, and press **Enter** within **five seconds** to go into Setup Mode. If you wait longer than five seconds, the unit reboots.

```
telnet 191.12.3.77 9999
```

**Note:** The IP address you just set is temporary and reverts to the default value when the unit's power is reset, unless you configure the unit with a static IP address and store the changes permanently.

## Appendix E: Binary to Hexadecimal Conversions

Many of the unit's configuration procedures require you to assemble a series of options (represented as bits) into a complete command (represented as a byte).

The resulting binary value must be converted to a hexadecimal representation.

Use this chapter to learn to convert binary values to hexadecimal or to look up hexadecimal values in the tables of configuration options. The tables include:

- ◆ Command Mode (serial string sign-on message)
- ◆ AES Keys

### Converting Binary to Hexadecimal

Following are two simple ways to convert binary numbers to hexadecimal notation.

#### Conversion Table

Hexadecimal digits have values ranging from 0 to F, which are represented as 0-9, A (for 10), B (for 11), etc. To convert a binary value (for example, 0100 1100) to a hexadecimal representation, treat the upper and lower four bits separately to produce a two-digit hexadecimal number (in this case, 4C). Use the following table to convert values from binary to hexadecimal.

#### Scientific Calculator

Another simple way to convert binary to hexadecimal is to use a scientific calculator, such as the one available on the Windows operating systems. For example:

1. On the Windows Start menu, click **Programs -> Accessories -> Calculator**.
2. On the View menu, select **Scientific**. The scientific calculator appears.
3. Click **Bin** (Binary), and type the number you want to convert.

**Table E-1 Binary to Hexadecimal Conversion**

Decimal	Binary	Hex
0	0000	0
1	0001	1
2	0010	2
3	0011	3
4	0100	4
5	0101	5
6	0110	6
7	0111	7
8	1000	8
9	1001	9
10	1010	A
11	1011	B
12	1100	C
13	1101	D
14	1110	E
15	1111	F

Figure E-2 Windows Scientific Calculator

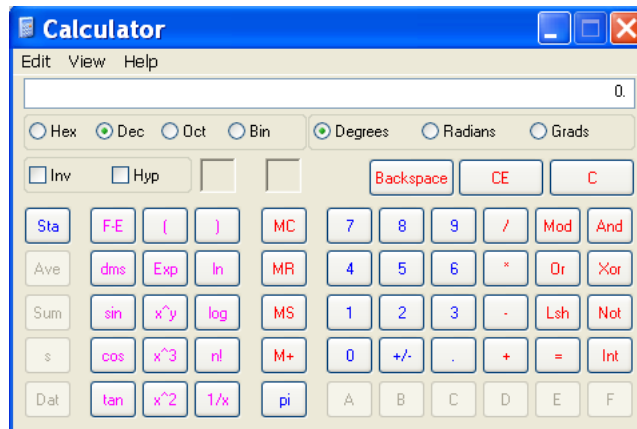

4. Click Hex. The hexadecimal value appears.

Figure E-3 Hexadecimal Values in the Scientific Calculator

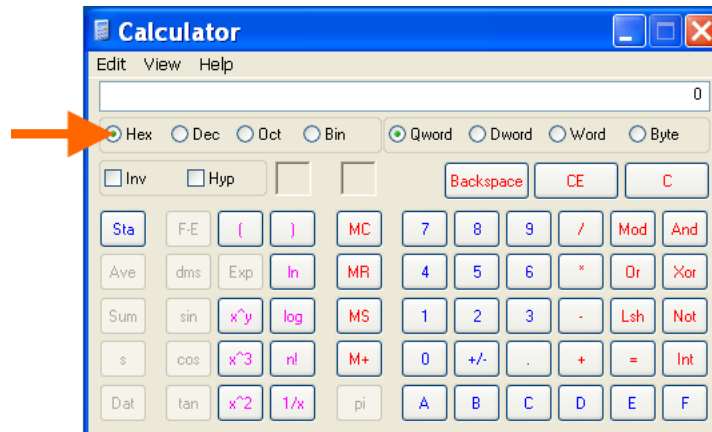



## Appendix F: Compliance

### Manufacturer's Name & Address

Lantronix, Inc.  
167 Technology Drive, Irvine, CA 92618 USA  
Tel: 800-526-8766  
Tel: 949-453-3990  
Fax: 949-450-7249

Declares that the following product:

**Product Name Model:** xDirect Device Server

Conforms to the following standards or other normative documents:

### Safety

- ◆ UL 60950-1, 2nd Edition
- ◆ CAN/CSA-C22.2 No. 60950-1-07, 2nd Edition
- ◆ IEC 60950-1:2005, 2nd Edition with National Deviations
- ◆ Low Voltage Directive (2006/95/EC)
- ◆ VCCI
- ◆ C-TICK

### Electromagnetic Emissions

- ◆ FCC Part 15 Subpart B, Class B
- ◆ Industry Canada ICES-003 Issue 4 February 2004
- ◆ CISPR 22:2008
- ◆ VCCI V-3/2011.04
- ◆ AS/NZS CISPR 22:2009
- ◆ EN 55022:2010
- ◆ EN 61000-3-2:2006 + A1:2009 + A2:2009
- ◆ EN 61000-3-3:2008
- ◆ ANSI C63.4:2009

### Electromagnetic Immunity

- ◆ EN 55024:2010
- ◆ EN 61000-4-2:2009
- ◆ EN 61000-4-3:2006 + A1:2008 + A2:2010
- ◆ EN 61000-4-4:2004 + A1:2010
- ◆ EN 61000-4-5:2006
- ◆ EN 61000-4-6:2009
- ◆ EN 61000-4-8:2010
- ◆ EN 61000-4-11:2004

**RoHS Notice**

All Lantronix products in the following families are China RoHS-compliant and free of the following hazardous substances and elements:

- ◆ Lead (Pb)
- ◆ Cadmium (Cd)
- ◆ Mercury (Hg)
- ◆ Hexavalent Chromium (Cr (VI))
- ◆ Polybrominated biphenyls (PBB)
- ◆ Polybrominated diphenyl ethers (PBDE)

Product Family Name	Toxic or hazardous Substances and Elements					
	Lead (Pb)	Mercury (Hg)	Cadmium (Cd)	Hexavalent Chromium (Cr (VI))	Polybrominated biphenyls (PBB)	Polybrominated diphenyl ethers (PBDE)
DSC	0	0	0	0	0	0
EDS	0	0	0	0	0	0
IntelliBox	0	0	0	0	0	0
MatchPort	0	0	0	0	0	0
Micro	0	0	0	0	0	0
MSS100	0	0	0	0	0	0
PremierWave	0	0	0	0	0	0
SCS	0	0	0	0	0	0
SecureBox	0	0	0	0	0	0
SLB	0	0	0	0	0	0
SLC	0	0	0	0	0	0
SLP	0	0	0	0	0	0
Spider and Spider Duo	0	0	0	0	0	0
UBox	0	0	0	0	0	0
UDS1100 and 2100	0	0	0	0	0	0
WiBox	0	0	0	0	0	0
WiPort	0	0	0	0	0	0
xDirect	0	0	0	0	0	0
xPico	0	0	0	0	0	0
XPort	0	0	0	0	0	0
XPress DR & XPress-DR+	0	0	0	0	0	0
xPrintServer	0	0	0	0	0	0
xSenso	0	0	0	0	0	0

O: toxic or hazardous substance contained in all of the homogeneous materials for this part is below the limit requirement in SJ/T11363-2006.

X: toxic or hazardous substance contained in at least one of the homogeneous materials used for this part is above the limit requirement in SJ/T11363-2006.