



## Standard Recovery Diodes (Stud Version), 300 A



DO-205AB (DO-9)

### FEATURES

- Wide current range
- High voltage rating up to 2500 V
- High surge current capabilities
- Stud cathode and stud anode version
- High resistance to acceleration
- Designed and qualified for industrial level
- Material categorization: for definitions of compliance please see [www.vishay.com/doc?99912](http://www.vishay.com/doc?99912)



**RoHS**  
COMPLIANT

### TYPICAL APPLICATIONS

- Converters
- Power supplies
- Machine tool controls
- High power drives
- Medium traction applications

PRODUCT SUMMARY	
$I_{F(AV)}$	300 A
Package	DO-205AB (DO-9)
Circuit configuration	Single diode

MAJOR RATINGS AND CHARACTERISTICS				
PARAMETER	TEST CONDITIONS	301U(R)		UNITS
		160 TO 200	250	
$I_{F(AV)}$		330	300	A
	$T_C$	120	120	°C
$I_{F(RMS)}$		520	470	A
$I_{FSM}$	50 Hz	8250	6050	A
	60 Hz	8640	6335	
$I^2t$	50 Hz	340	183	kA <sup>2</sup> s
	60 Hz	311	167	
$V_{RRM}$	Range	1600 to 2000	2500	V
$T_J$		-40 to 180	-40 to 180	°C

### ELECTRICAL SPECIFICATIONS

VOLTAGE RATINGS				
TYPE NUMBER	VOLTAGE CODE	$V_{RRM}$ , MAXIMUM REPETITIVE PEAK REVERSE VOLTAGE V	$V_{RSM}$ , MAXIMUM NON-REPETITIVE PEAK REVERSE VOLTAGE V	$I_{RRM}$ MAXIMUM AT $T_J = T_J$ MAXIMUM mA
VS-301U(R) VS-303U(R)	160	1600	1700	15
VS-305U(R) VS-307U(R)	200	2000	2100	
VS-309U(R)	250	2500	2600	



<b>FORWARD CONDUCTION</b>							
PARAMETER	SYMBOL	TEST CONDITIONS		301U(R)		UNITS	
				160 TO 200	250		
Maximum average forward current at case temperature	$I_{F(AV)}$	180° conduction, half sine wave		330	300	A	
				120	120	°C	
Maximum RMS forward current	$I_{F(RMS)}$	DC at $T_C = 115\text{ °C}$ (up to 2000 V), $T_C = 102\text{ °C}$ (2500 V)		520	470	A	
Maximum peak, one cycle forward, non-repetitive surge current	$I_{FSM}$	t = 10 ms	No voltage reapplied	Sinusoidal half wave, initial $T_J = T_J$ maximum	8250	6050	A
		t = 8.3 ms			8640	6335	
		t = 10 ms	100 % $V_{RRM}$ reapplied		6940	5090	
		t = 8.3 ms			7270	5330	
Maximum $I^2t$ for fusing	$I^2t$	t = 10 ms	No voltage reapplied		340	183	kA <sup>2</sup> s
		t = 8.3 ms			311	167	
		t = 10 ms	100 % $V_{RRM}$ reapplied		241	129	
		t = 8.3 ms			220	118	
Maximum $I^2\sqrt{t}$ for fusing	$I^2\sqrt{t}$	t = 0.1 to 10 ms, no voltage reapplied		3400	1830	kA <sup>2</sup> √s	
Low level value of threshold voltage	$V_{F(TO)1}$	(16.7 % $\times \pi \times I_{F(AV)} < I < \pi \times I_{F(AV)}$ , $T_J = T_J$ maximum)		0.77	0.90	V	
High level value of threshold voltage	$V_{F(TO)2}$	(I > $\pi \times I_{F(AV)}$ , $T_J = T_J$ maximum)		0.84	0.97		
Low level value of forward slope resistance	$r_{f1}$	(16.7 % $\times \pi \times I_{F(AV)} < I < \pi \times I_{F(AV)}$ , $T_J = T_J$ maximum)		0.49	0.59	mΩ	
High level value of forward slope resistance	$r_{f2}$	(I > $\pi \times I_{F(AV)}$ , $T_J = T_J$ maximum)		0.49	0.55		
Maximum forward voltage drop	$V_{FM}$	$I_{pk} = 942\text{ A}$ , $T_J = T_J$ maximum, $t_p = 10\text{ ms}$ sinusoidal wave		1.22	1.46	V	

<b>SPECIAL SELECTION FORWARD VOLTAGE (<math>T_j = 25\text{ °C}</math>)</b>					
DEVICE CLASSIFICATION	BAND	MIN.	MAX.	UNIT	TEST CONDITIONS
VS-305U250P4 VS-307UA250P4 VS-305UR250P4 VS-307URA250P4	P4	1.31	1.40	V	1000 A <sub>pk</sub>

<b>THERMAL AND MECHANICAL SPECIFICATIONS</b>					
PARAMETER	SYMBOL	TEST CONDITIONS		VALUES	UNITS
Maximum junction operating temperature range	$T_J$			-40 to 180	°C
Maximum storage temperature range	$T_{Stg}$			-40 to 200	
Maximum thermal resistance, junction to case	$R_{thJC}$	DC operation		0.14	K/W
Maximum thermal resistance, case to heatsink	$R_{thCS}$	Mounting surface, smooth, flat and greased		0.08	
Maximum allowed mounting torque +0 -20 %		Not lubricated threads		37	N · m
		Lubricated threads		28	
Weight	301U			250 ± 5	g
	303U			152 ± 5	
	305U			177 ± 5	
	307U			197 ± 5	
	309U			160 ± 5	
Case style		See dimensions - link at the end of datasheet		DO-205AB (DO-9)	



<b><math>\Delta R_{thJC}</math> CONDUCTION</b>						
CONDUCTION ANGLE	SINUSOIDAL CONDUCTION		RECTANGULAR CONDUCTION		TEST CONDITIONS	UNITS
	80 TO 200	250	80 TO 200	250		
180°	0.015	0.015	0.011	0.011	$T_J = T_J$ maximum	K/W
120°	0.018	0.018	0.019	0.019		
90°	0.023	0.023	0.025	0.025		
60°	0.034	0.034	0.035	0.035		
30°	0.056	0.056	0.057	0.057		

**Note**

- The table above shows the increment of thermal resistance  $R_{thJC}$  when devices operate at different conduction angles than DC

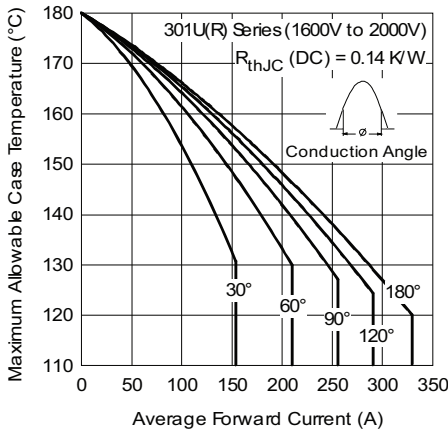

Fig. 1 - Current Ratings Characteristics

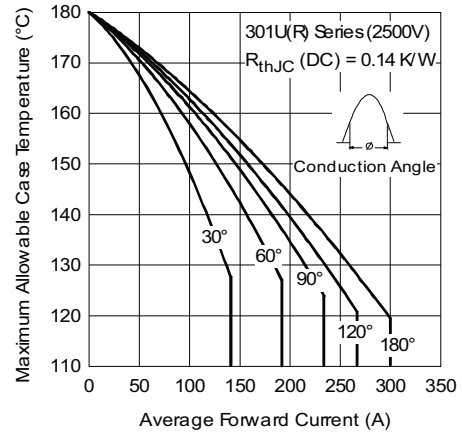

Fig. 2 - Current Ratings Characteristics

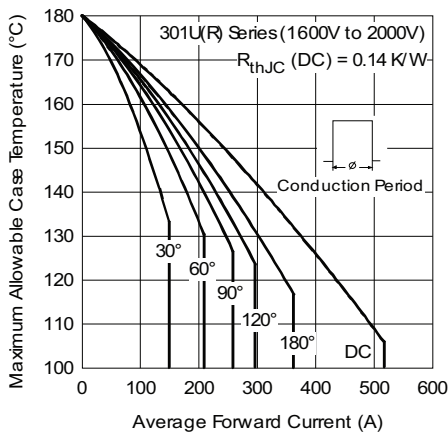

Fig. 1 - Current Ratings Characteristics

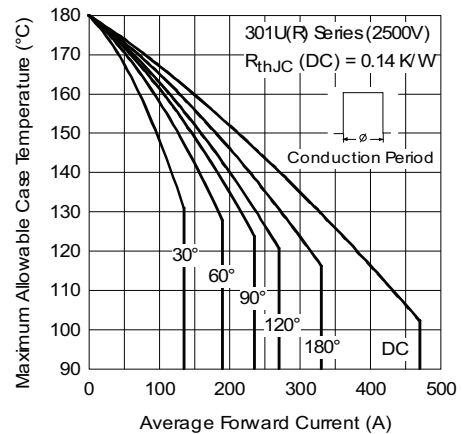

Fig. 3 - Current Ratings Characteristics



Fig. 4 - Forward Power Loss Characteristics



Fig. 5 - Forward Power Loss Characteristics

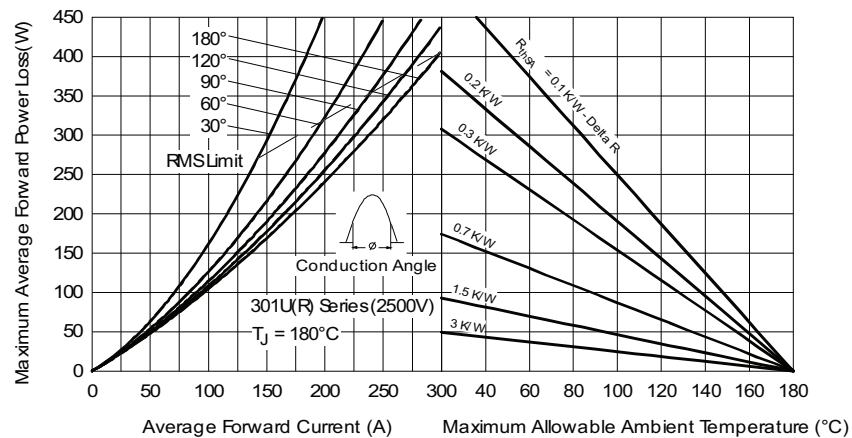

Fig. 6 - Forward Power Loss Characteristics

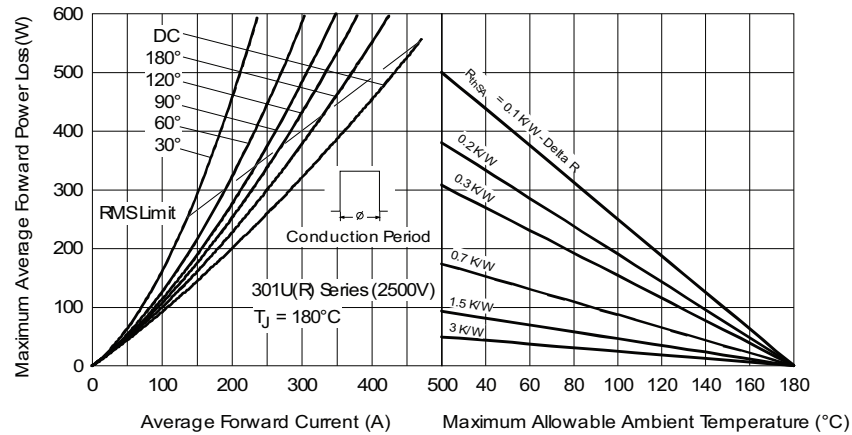

Fig. 7 - Forward Power Loss Characteristics



Fig. 8 - Maximum Non-Repetitive Surge Current



Fig. 10 - Maximum Non-Repetitive Surge Current



Fig. 9 - Maximum Non-Repetitive Surge Current



Fig. 11 - Maximum Non-Repetitive Surge Current



Fig. 12 - Forward Voltage Drop Characteristics



Fig. 13 - Forward Voltage Drop Characteristics



Fig. 14 - Thermal Impedance  $Z_{thJC}$  Characteristic



**ORDERING INFORMATION TABLE**



- 1** - Vishay Semiconductors product
- 2** - 30 = essential part number
- 3** -
  - 1 = standard device
  - 3 = top threaded version
  - 5 = type for rotating application with top threaded version 3/8 16UNC-2A
  - 7 = type for rotating application with flexible lead
  - 9 = type for rotating application with top threaded version 3/8 24UNF
- 4** -
  - U = stud normal polarity (cathode to stud)
  - UR = stud reverse polarity (anode to stud)
- 5** - A = maximum leakage selection  $I_{RRM} = 2 \text{ mA}$ ,  $T_J = 25 \text{ }^\circ\text{C}$
- 6** - Voltage code  $\times 10 = V_{RRM}$  (see Voltage Ratings table)
- 7** - Refer special selection table for applicable parts

**LINKS TO RELATED DOCUMENTS**

Dimensions	<a href="http://www.vishay.com/doc?95337">www.vishay.com/doc?95337</a>
------------	--

## DO-205AB (DO-9), B-60, B-61, B-41, B-40 for 301U(R), 307U(R), 305U(R) and 309U(R) Series

**DIMENSIONS FOR 301U(R) SERIES - DO-205AB (DO-9)** in millimeters (inches)





# Outline Dimensions



Vishay Semiconductors DO-205AB (DO-9), B-60, B-61, B-41, B-40 for 301U(R), 307U(R), 305U(R) and 309U(R) Series

## DIMENSIONS FOR 307U(R) SERIES - B-60 in millimeters (inches)

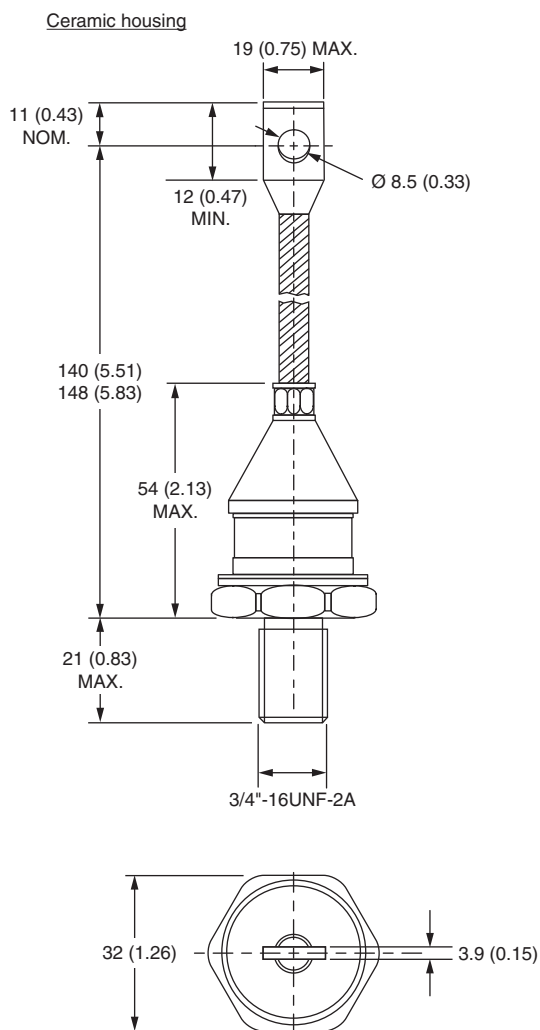



## DIMENSIONS FOR 305U(R) SERIES - B-61 in millimeters (inches)



## DIMENSIONS FOR 309U(R) SERIES - B-41 in millimeters (inches)



# Outline Dimensions



Vishay Semiconductors DO-205AB (DO-9), B-60, B-61, B-41, B-40 for 301U(R), 307U(R), 305U(R) and 309U(R) Series

## DIMENSIONS FOR 303U(R) SERIES - B-40 in millimeters (inches)





## **Disclaimer**

ALL PRODUCT, PRODUCT SPECIFICATIONS AND DATA ARE SUBJECT TO CHANGE WITHOUT NOTICE TO IMPROVE RELIABILITY, FUNCTION OR DESIGN OR OTHERWISE.

Vishay Intertechnology, Inc., its affiliates, agents, and employees, and all persons acting on its or their behalf (collectively, "Vishay"), disclaim any and all liability for any errors, inaccuracies or incompleteness contained in any datasheet or in any other disclosure relating to any product.

Vishay makes no warranty, representation or guarantee regarding the suitability of the products for any particular purpose or the continuing production of any product. To the maximum extent permitted by applicable law, Vishay disclaims (i) any and all liability arising out of the application or use of any product, (ii) any and all liability, including without limitation special, consequential or incidental damages, and (iii) any and all implied warranties, including warranties of fitness for particular purpose, non-infringement and merchantability.

Statements regarding the suitability of products for certain types of applications are based on Vishay's knowledge of typical requirements that are often placed on Vishay products in generic applications. Such statements are not binding statements about the suitability of products for a particular application. It is the customer's responsibility to validate that a particular product with the properties described in the product specification is suitable for use in a particular application. Parameters provided in datasheets and / or specifications may vary in different applications and performance may vary over time. All operating parameters, including typical parameters, must be validated for each customer application by the customer's technical experts. Product specifications do not expand or otherwise modify Vishay's terms and conditions of purchase, including but not limited to the warranty expressed therein.

Except as expressly indicated in writing, Vishay products are not designed for use in medical, life-saving, or life-sustaining applications or for any other application in which the failure of the Vishay product could result in personal injury or death. Customers using or selling Vishay products not expressly indicated for use in such applications do so at their own risk. Please contact authorized Vishay personnel to obtain written terms and conditions regarding products designed for such applications.

No license, express or implied, by estoppel or otherwise, to any intellectual property rights is granted by this document or by any conduct of Vishay. Product names and markings noted herein may be trademarks of their respective owners.

# Mouser Electronics

Authorized Distributor

Click to View Pricing, Inventory, Delivery & Lifecycle Information:

[Vishay:](#)

[VS-301UA200](#) [VS-301U200](#) [VS-307UR160](#) [VS-301UR160](#) [VS-301U250](#) [VS-303UA250](#) [VS-305UR250P4](#) [VS-305U200](#) [VS-305UR200](#) [VS-307U160](#) [VS-307UR250](#) [VS-309U160](#) [VS-309U250](#) [VS-309UA250](#) [VS-309URA200](#) [VS-301UR250](#) [VS-301URA180](#) [VS-305U160](#) [VS-303URA200](#) [VS-305UA250](#) [VS-301URA250](#) [VS-309UR160](#) [VS-305URA160](#) [VS-307URA250](#) [VS-301URA240](#) [VS-301URA80](#) [VS-303URA160](#) [VS-305UR160](#) [VS-307URA160](#) [VS-307URA200](#) [VS-309UR250](#) [VS-301U160](#) [VS-307U250](#) [VS-305URA250](#) [VS-301UR200](#) [VS-301URA200](#) [VS-309URA160](#) [VS-309UR120](#) [VS-305U250](#) [VS-301URA160](#) [VS-309URA250](#) [VS-303URA250](#) [VS-309UA160](#) [VS-301URA120](#) [VS-305URA200](#)