

Notice for TAIYO YUDEN products

Please read this notice before using the TAIYO YUDEN products.

REMINDERS

- Product information in this catalog is as of October 2016. All of the contents specified herein are subject to change without notice due to technical improvements, etc. Therefore, please check for the latest information carefully before practical application or use of our products.

Please note that TAIYO YUDEN shall not be in any way responsible for any damages and defects in products or equipment incorporating our products, which are caused under the conditions other than those specified in this catalog or individual specification.

- Please contact TAIYO YUDEN for further details of product specifications as the individual specification is available.
- Please conduct validation and verification of our products in actual condition of mounting and operating environment before using our products.
- The products listed in this catalog are intended for use in general electronic equipment (e.g., AV equipment, OA equipment, home electric appliances, office equipment, information and communication equipment), general medical equipment, industrial equipment, and automotive interior applications, etc. Please be sure to contact TAIYO YUDEN for further information before using the products for any equipment which may directly cause loss of human life or bodily injury (e.g., specially controlled medical equipment, transportation equipment including, without limitation, automotive powertrain control system, train control system, and ship control system, traffic signal equipment).

Please do not incorporate our products into any equipment requiring high levels of safety and/or reliability (e.g., aerospace equipment, aviation equipment, nuclear control equipment, undersea equipment, military equipment).

When our products are used even for high safety and/or reliability-required devices or circuits of general electronic equipment, it is strongly recommended to perform a thorough safety evaluation prior to use of our products and to install a protection circuit as necessary.

Please note that unless you obtain prior written consent of TAIYO YUDEN, TAIYO YUDEN shall not be in any way responsible for any damages incurred by you or third parties arising from use of the products listed in this catalog for any equipment requiring inquiry to TAIYO YUDEN or prohibited for use by TAIYO YUDEN as described above.

- Please note that TAIYO YUDEN shall have no responsibility for any controversies or disputes that may occur in connection with a third party's intellectual property rights and other related rights arising from use of our products. TAIYO YUDEN grants no license for such rights.
- Please note that unless otherwise agreed in writing, the scope of warranty for our products is limited to the delivered our products themselves and TAIYO YUDEN shall not be in any way responsible for any damages resulting from a fault or defect in our products.
- The contents of this catalog are applicable to our products which are purchased from our sales offices or authorized distributors (hereinafter "TAIYO YUDEN's official sales channel"). Please note that the contents of this catalog are not applicable to our products purchased from any seller other than TAIYO YUDEN's official sales channel.
- Caution for Export
Some of our products listed in this catalog may require specific procedures for export according to "U.S. Export Administration Regulations", "Foreign Exchange and Foreign Trade Control Law" of Japan, and other applicable regulations. Should you have any questions on this matter, please contact our sales staff.



REFLOW

AEC-200

MULTILAYER CERAMIC CAPACITORS

■ PART NUMBER

| | | | | | | | | | | | | | | | | |
|---|---|---|---|---|---|---|---|---|---|---|---|---|---|---|---|---|
| J | M | K | 3 | 1 | 6 | △ | B | J | 1 | 0 | 6 | M | L | H | T | △ |
| ① | ② | ③ | ④ | ⑤ | ⑥ | ⑦ | ⑧ | ⑨ | ⑩ | ⑪ | ⑫ | | | | | |

△=Blank space

① Rated voltage

| Code | Rated voltage[VDC] |
|------|--------------------|
| A | 4 |
| J | 6.3 |
| L | 10 |
| E | 16 |
| T | 25 |
| G | 35 |
| U | 50 |
| H | 100 |
| Q | 250 |
| S | 630 |

② Series name

| Code | Series name |
|------|---|
| M | Multilayer ceramic capacitor |
| V | Multilayer ceramic capacitor for high frequency |
| W | LW reverse type multilayer capacitor |

③ End termination

| Code | End termination |
|------|------------------------------|
| K | Plated |
| J | Soft Termination |
| S | Cu Internal Electrodes |
| R | High Reliability Application |

④ Dimension (L × W)

| Type | Dimensions (L × W) [mm] | EIA (inch) |
|------|-------------------------|------------|
| 063 | 0.6 × 0.3 | 0201 |
| 105 | 1.0 × 0.5 | 0402 |
| | 0.52 × 1.0 ※ | 0204 |
| 107 | 1.6 × 0.8 | 0603 |
| | 0.8 × 1.6 ※ | 0306 |
| 212 | 2.0 × 1.25 | 0805 |
| | 1.25 × 2.0 ※ | 0508 |
| 316 | 3.2 × 1.6 | 1206 |
| 325 | 3.2 × 2.5 | 1210 |
| 432 | 4.5 × 3.2 | 1812 |

Note : ※LW reverse type (□WK) only

⑤ Dimension tolerance

| Code | Type | L [mm] | W [mm] | T [mm] |
|------|------|----------------|-----------------|------------------------------|
| △ | ALL | Standard | Standard | Standard |
| A | 063 | 0.6±0.05 | 0.3±0.05 | 0.3±0.05 |
| | 105 | 1.0±0.10 | 0.5±0.10 | 0.5±0.10 |
| | 107 | 1.6+0.15/-0.05 | 0.8+0.15/-0.05 | 0.8+0.15/-0.05 |
| | 212 | 2.0+0.15/-0.05 | 1.25+0.15/-0.05 | 0.85±0.10 1.25+0.15/-0.05 |
| | 316 | 3.2±0.20 | 1.6±0.20 | 1.6±0.20 |
| | 325 | 3.2±0.30 | 2.5±0.30 | 2.5±0.30 |
| B | 105 | 1.0+0.15/-0.05 | 0.5+0.15/-0.05 | 0.5+0.15/-0.05 |
| | 107 | 1.6+0.20/-0 | 0.8+0.20/-0 | 0.8+0.20/-0 |
| | 212 | 2.0+0.20/-0 | 1.25+0.20/-0 | 0.85±0.10 1.25+0.20/-0 |
| C | 105 | 1.0+0.20/-0 | 0.5+0.20/-0 | 0.5+0.20/-0 |
| | 107 | 1.6+0.25/-0 | 0.8+0.25/-0 | 0.8+0.25/-0 |
| | 212 | 2.0+0.25/-0 | 1.25+0.25/-0 | 1.25+0.25/-0 |
| K | 212 | 2.0±0.15 | 1.25±0.15 | 0.85±0.15 |
| | 316 | 3.2±0.20 | 1.6±0.20 | 1.15±0.20 1.6±0.20 |
| | 325 | 3.2±0.50 | 2.5±0.30 | 2.5±0.30 |

Note: P. 22 Standard external dimensions

△= Blank space

⑥ Temperature characteristics code

■ High dielectric type

| Code | Applicable standard | Temperature range [°C] | Ref. Temp. [°C] | Capacitance change | Capacitance tolerance | Tolerance code |
|------|---------------------|------------------------|-----------------|--------------------|-----------------------|----------------|
| BJ | EIA X5R | -55 ~ + 85 | 25 | ± 15% | ± 10% | K |
| | | | | | ± 20% | M |
| C6 | EIA X6S | -55 ~ + 105 | 25 | ± 22% | ± 10% | K |
| | | | | | ± 20% | M |
| B7 | EIA X7R | -55 ~ + 125 | 25 | ± 15% | ± 10% | K |
| | | | | | ± 20% | M |
| C7 | EIA X7S | -55 ~ + 125 | 25 | ± 22% | ± 10% | K |
| | | | | | ± 20% | M |
| D7 | EIA X7T | -55 ~ + 125 | 25 | + 22% / - 33% | ± 10% | K |
| | | | | | ± 20% | M |

▶ This catalog contains the typical specification only due to the limitation of space. When you consider the purchase of our products, please check our specification. For details of each product (characteristics graph, reliability information, precautions for use, and so on), see our website (<http://www.ty-top.com/>).

■ Temperature compensating type

| Code | Applicable standard | | Temperature range [°C] | Ref. Temp. [°C] | Capacitance change | Capacitance tolerance | Tolerance code |
|------|---------------------|-----|------------------------|-----------------|--------------------|-----------------------|----------------|
| CG | JIS | CG | -55 ~ +125 | 20 | 0 ± 30 ppm/°C | ± 0.1 pF | B |
| | | | | | | ± 0.25 pF | C |
| | | | | | | ± 0.5 pF | D |
| | EIA | COG | | 25 | | ± 1 pF | F |
| | | | | | | ± 2% | G |
| | | | | | | ± 5% | J |

⑦ Nominal capacitance

| Code (example) | Nominal capacitance |
|----------------|---------------------|
| 0R5 | 0.5 pF |
| 010 | 1 pF |
| 100 | 10 pF |
| 101 | 100 pF |
| 102 | 1,000 pF |
| 103 | 0.01 μ F |
| 104 | 0.1 μ F |
| 105 | 1.0 μ F |
| 106 | 10 μ F |
| 107 | 100 μ F |

Note : R=Decimal point

⑧ Capacitance tolerance

| Code | Capacitance tolerance |
|------|-----------------------|
| B | ± 0.1 pF |
| C | ± 0.25 pF |
| D | ± 0.5 pF |
| G | ± 2% |
| J | ± 5% |
| K | ± 10% |
| M | ± 20% |

⑨ Thickness

| Code | Thickness [mm] |
|------|-------------------------|
| P | 0.3 |
| T | |
| V | 0.5 |
| C | 0.7 (107 type or more) |
| A | 0.8 |
| D | 0.85 (212 type or more) |
| F | 1.15 |
| G | 1.25 |
| H | 1.5 |
| L | 1.6 |
| N | 1.9 |
| M | 2.5 |

⑩ Special code

| Code | Special code |
|------|------------------------------------|
| H | MLCC for Industrial and Automotive |

⑪ Packaging

| Code | Packaging |
|------|--|
| F | φ 178mm Taping (2mm pitch) |
| R | φ 178mm Embossed Taping (4mm pitch) |
| T | φ 178mm Taping (4mm pitch) |
| P | φ 178mm Taping (4mm pitch, 1000 pcs/reel) 325 type (Thickness code M) |

⑫ Internal code

| Code | Internal code |
|------|---------------|
| △ | Standard |

STANDARD EXTERNAL DIMENSIONS

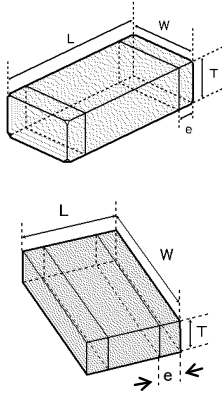

※ LW reverse type

| Type(EIA) | Dimension [mm] (inch) | | | | |
|---------------|----------------------------|----------------------------|----------------------------|----|--|
| | L | W | T | *1 | e |
| □MK063(0201) | 0.6±0.03 (0.024±0.001) | 0.3±0.03 (0.012±0.001) | 0.3±0.03 (0.012±0.001) | T | 0.15±0.05 (0.006±0.002) |
| □MK105(0402) | 1.0±0.05 (0.039±0.002) | 0.5±0.05 (0.020±0.002) | 0.5±0.05 (0.020±0.002) | V | 0.25±0.10 (0.010±0.004) |
| □WK105(0204)※ | 0.52±0.05 (0.020±0.002) | 1.0±0.05 (0.039±0.002) | 0.3±0.05 (0.012±0.002) | P | 0.18±0.08 (0.007±0.003) |
| □MK107(0603) | 1.6±0.10 (0.063±0.004) | 0.8±0.10 (0.031±0.004) | 0.8±0.10 (0.031±0.004) | A | 0.35±0.25 (0.014±0.010) |
| □MJ107(0603) | 1.6±0.10 (0.063±0.004) | 0.8±0.10 (0.031±0.004) | 0.8±0.10 (0.031±0.004) | A | 0.35+0.3/-0.25 (0.014+0.012/-0.010) |
| □VS107(0603) | 1.6±0.10 (0.063±0.004) | 0.8±0.10 (0.031±0.004) | 0.7±0.10 (0.028±0.004) | C | 0.35±0.25 (0.014±0.010) |
| □MR107(0603) | 1.6±0.10 (0.063±0.004) | 0.8±0.10 (0.031±0.004) | 0.8±0.10 (0.031±0.004) | A | 0.1~0.6 (0.004~0.024) |
| □WK107(0306)※ | 0.8±0.10 (0.031±0.004) | 1.6±0.10 (0.063±0.004) | 0.5±0.05 (0.020±0.002) | V | 0.25±0.15 (0.010±0.006) |
| □MK212(0805) | 2.0±0.10 (0.079±0.004) | 1.25±0.10 (0.049±0.004) | 0.85±0.10 (0.033±0.004) | D | 0.5±0.25 (0.020±0.010) |
| | | | 1.25±0.10 (0.049±0.004) | G | |
| □MJ212(0805) | 2.0±0.10 (0.079±0.004) | 1.25±0.10 (0.049±0.004) | 0.85±0.10 (0.033±0.004) | D | 0.5+0.35/-0.25 (0.020+0.014/-0.010) |
| | | | 1.25±0.10 (0.049±0.004) | G | |
| □VS212(0805) | 2.0±0.10 (0.079±0.004) | 1.25±0.10 (0.049±0.004) | 0.85±0.10 (0.033±0.004) | D | 0.5±0.25 (0.020±0.010) |
| □MR212(0805) | 2.0±0.10 (0.079±0.004) | 1.25±0.10 (0.049±0.004) | 1.25±0.10 (0.049±0.004) | G | 0.25~0.75 (0.010~0.029) |
| □WK212(0508)※ | 1.25±0.15 (0.049±0.006) | 2.0±0.15 (0.079±0.006) | 0.85±0.10 (0.033±0.004) | D | 0.3±0.2 (0.012±0.008) |
| □MK316(1206) | 3.2±0.15 (0.126±0.006) | 1.6±0.15 (0.063±0.006) | 1.15±0.10 (0.045±0.004) | F | 0.5+0.35/-0.25 (0.020+0.014/-0.010) |
| | | | 1.6±0.20 (0.063±0.008) | L | |
| □MJ316(1206) | 3.2±0.15 (0.126±0.006) | 1.6±0.15 (0.063±0.006) | 1.15±0.10 (0.045±0.004) | F | 0.6+0.4/-0.3 (0.024+0.016/-0.012) |
| | | | 1.6±0.20 (0.063±0.008) | L | |
| □MR316(1206) | 3.2±0.15 (0.126±0.006) | 1.6±0.15 (0.063±0.006) | 1.6±0.20 (0.063±0.008) | L | 0.25~0.85 (0.010~0.033) |
| □MK325(1210) | 3.2±0.30 (0.126±0.012) | 2.5±0.20 (0.098±0.008) | 1.15±0.10 (0.045±0.004) | F | 0.6±0.3 (0.024±0.012) |
| | | | 1.5±0.10 (0.059±0.004) | H | |
| | | | 1.9±0.20 (0.075±0.008) | N | |
| | | | 2.5±0.20 (0.098±0.008) | M | |
| □MJ325(1210) | 3.2±0.30 (0.126±0.012) | 2.5±0.20 (0.098±0.008) | 1.9±0.20 (0.075±0.008) | N | 0.6+0.4/-0.3 (0.024+0.016/-0.012) |
| | | | 2.5±0.20 (0.098±0.008) | M | |
| □MR325(1210) | 3.2±0.30 (0.126±0.012) | 2.5±0.20 (0.098±0.008) | 1.9±0.20 (0.075±0.008) | N | 0.3~0.9 (0.012~0.035) |
| | | | 2.5±0.20 (0.098±0.008) | M | |
| □MK432(1812) | 4.5±0.40 (0.177±0.016) | 3.2±0.30 (0.126±0.012) | 2.5±0.20 (0.098±0.008) | M | 0.9±0.6 (0.035±0.024) |

Note : ※. LW reverse type, *1.Thickness code

► This catalog contains the typical specification only due to the limitation of space. When you consider the purchase of our products, please check our specification. For details of each product (characteristics graph, reliability information, precautions for use, and so on), see our website (<http://www.ty-top.com/>).

■ STANDARD QUANTITY

| Type | EIA (inch) | Dimension | | Standard quantity [pcs] | |
|------|------------|-----------|------|----------------------------|----------------------------|
| | | [mm] | Code | Paper tape | Embossed tape |
| 063 | 0201 | 0.3 | T | 15000 | — |
| 105 | 0402 | 0.5 | V | 10000 | — |
| | 0204 ※ | 0.30 | P | | |
| 107 | 0603 | 0.7 | C | 4000 | — |
| | | 0.8 | A | | |
| | | 0.8 | A | 3000 (Soft Termination) | — |
| | | 0.8 | A | — | 3000 (Soft Termination) |
| | 0306 ※ | 0.50 | V | — | 4000 |
| 212 | 0805 | 0.85 | D | 4000 | — |
| | | 1.25 | G | — | 3000 |
| | | 1.25 | G | — | 2000 (Soft Termination) |
| | 0508 ※ | 0.85 | D | 4000 | — |
| 316 | 1206 | 1.15 | F | — | 3000 |
| | | 1.6 | L | — | 2000 |
| 325 | 1210 | 1.15 | F | — | 2000 |
| | | 1.5 | H | | |
| | | 1.9 | N | — | — |
| | | 2.5 | M | — | 500(T), 1000(P) |
| 432 | 1812 | 2.5 | M | — | 500 |

Note : ※:LW Reverse type (□WK)

■ PART NUMBER

Soft Termination Multilayer Ceramic Capacitors

● **107TYPE (Dimension:1.6×0.8mm JIS:1608 EIA:0603)**

[Temperature Characteristic B7 : X7R] 0.8mm thickness(A)

| Part number 1 | Part number 2 | Rated voltage [V] | Temperature characteristics | Capacitance [F] | Capacitance tolerance [%] | tan δ [%] | HRTL | | Thickness*3 [mm] | Note |
|------------------|---------------|-------------------|-----------------------------|-----------------|---------------------------|-----------|-------------------|----------------|------------------|------|
| | | | | | | | Rated voltage x % | | | |
| TMJ107BB7473□AHT | | 25 | X7R | 0.047 μ | ±10, ±20 | 3.5 | 200 | 0.8+0.20/-0 | *1, *2 | |
| TMJ107BB7104□AHT | | | X7R | 0.1 μ | ±10, ±20 | 3.5 | 200 | 0.8+0.20/-0 | *1, *2 | |
| TMJ107BB7224□AHT | | | X7R | 0.22 μ | ±10, ±20 | 10 | 150 | 0.8+0.20/-0 | *1, *2 | |
| TMJ107BB7474□AHT | | | X7R | 0.47 μ | ±10, ±20 | 10 | 150 | 0.8+0.20/-0 | *1, *2 | |
| TMJ107CB7105□AHR | | | X7R | 1 μ | ±10, ±20 | 10 | 150 | 0.8+0.25/-0 | *1, *2 | |
| GMJ107BB7473□AHT | | | X7R | 0.047 μ | ±10, ±20 | 3.5 | 200 | 0.8+0.20/-0 | *1, *2 | |
| GMJ107BB7104□AHT | | 35 | X7R | 0.1 μ | ±10, ±20 | 3.5 | 200 | 0.8+0.20/-0 | *1, *2 | |
| GMJ107BB7224□AHT | | | X7R | 0.22 μ | ±10, ±20 | 10 | 150 | 0.8+0.20/-0 | *1, *2 | |
| GMJ107BB7474□AHT | | | X7R | 0.47 μ | ±10, ±20 | 10 | 150 | 0.8+0.20/-0 | *1, *2 | |
| GMJ107CB7105□AHR | | | X7R | 1 μ | ±10, ±20 | 10 | 150 | 0.8+0.25/-0 | *1, *2 | |
| UMJ107AB7102□AHT | | | X7R | 1000 p | ±10, ±20 | 3.5 | 200 | 0.8+0.15/-0.05 | *1, *2 | |
| UMJ107AB7222□AHT | | | X7R | 2200 p | ±10, ±20 | 3.5 | 200 | 0.8+0.15/-0.05 | *1, *2 | |
| UMJ107BB7472□AHT | | 50 | X7R | 4700 p | ±10, ±20 | 3.5 | 200 | 0.8+0.20/-0 | *1, *2 | |
| UMJ107BB7103□AHT | | | X7R | 0.01 μ | ±10, ±20 | 3.5 | 200 | 0.8+0.20/-0 | *1, *2 | |
| UMJ107BB7223□AHT | | | X7R | 0.022 μ | ±10, ±20 | 3.5 | 200 | 0.8+0.20/-0 | *1, *2 | |
| UMJ107BB7473□AHT | | | X7R | 0.047 μ | ±10, ±20 | 3.5 | 200 | 0.8+0.20/-0 | *1, *2 | |
| UMJ107BB7104□AHT | | | X7R | 0.1 μ | ±10, ±20 | 3.5 | 200 | 0.8+0.20/-0 | *1, *2 | |
| HMJ107AB7102□AHT | | | X7R | 1000 p | ±10, ±20 | 3.5 | 200 | 0.8+0.15/-0.05 | *1, *2 | |
| HMJ107AB7222□AHT | | 100 | X7R | 2200 p | ±10, ±20 | 3.5 | 200 | 0.8+0.15/-0.05 | *1, *2 | |
| HMJ107BB7472□AHT | | | X7R | 4700 p | ±10, ±20 | 3.5 | 200 | 0.8+0.20/-0 | *1, *2 | |
| HMJ107BB7103□AHT | | | X7R | 0.01 μ | ±10, ±20 | 3.5 | 200 | 0.8+0.20/-0 | *1, *2 | |
| HMJ107BB7223□AHT | | | X7R | 0.022 μ | ±10, ±20 | 3.5 | 200 | 0.8+0.20/-0 | *1, *2 | |
| HMJ107BB7473□AHT | | | X7R | 0.047 μ | ±10, ±20 | 3.5 | 200 | 0.8+0.20/-0 | *1, *2 | |
| HMJ107BB7104□AHT | | | X7R | 0.1 μ | ±10, ±20 | 3.5 | 200 | 0.8+0.20/-0 | *1, *2 | |

● **212TYPE (Dimension:2.0×1.25mm JIS:2012 EIA:0805)**

[Temperature Characteristic B7 : X7R] 0.85mm thickness(D) , 1.25mm thickness(G)

| Part number 1 | Part number 2 | Rated voltage [V] | Temperature characteristics | Capacitance [F] | Capacitance tolerance [%] | tan δ [%] | HRTL | | Thickness*3 [mm] | Note |
|------------------|---------------|-------------------|-----------------------------|-----------------|---------------------------|-----------|-------------------|--------------|------------------|--------|
| | | | | | | | Rated voltage x % | | | |
| JMJ212CB7106□GHT | | 6.3 | X7R | 10 μ | ±10, ±20 | 10 | 150 | 1.25+0.25/-0 | *1, *2 | |
| EMJ212CB7225□GHT | | 16 | X7R | 2.2 μ | ±10, ±20 | 10 | 150 | 1.25+0.25/-0 | *1, *2 | |
| EMJ212CB7475□GHT | | | X7R | 4.7 μ | ±10, ±20 | 10 | 150 | 1.25+0.25/-0 | *1, *2 | |
| TMJ212CB7225□GHT | | 25 | X7R | 2.2 μ | ±10, ±20 | 10 | 150 | 1.25+0.25/-0 | *1, *2 | |
| GMJ212CB7105□GHT | | 35 | X7R | 1 μ | ±10, ±20 | 10 | 150 | 1.25+0.25/-0 | *1, *2 | |
| UMJ212BB7103□GHT | | | X7R | 0.01 μ | ±10, ±20 | 2.5 | 200 | 1.25+0.20/-0 | *1, *2 | |
| UMJ212BB7223□GHT | | 50 | X7R | 0.022 μ | ±10, ±20 | 2.5 | 200 | 1.25+0.20/-0 | *1, *2 | |
| UMJ212BB7473□GHT | | | X7R | 0.047 μ | ±10, ±20 | 3.5 | 200 | 1.25+0.20/-0 | *1, *2 | |
| UMJ212BB7104□GHT | | | X7R | 0.1 μ | ±10, ±20 | 3.5 | 200 | 1.25+0.20/-0 | *1, *2 | |
| UMJ212CB7105□GHT | | | X7R | 1 μ | ±10, ±20 | 10 | 150 | 1.25+0.25/-0 | *1, *2 | |
| HMJ212KB7102□DHT | | | 100 | X7R | 1000 p | ±10, ±20 | 2.5 | 200 | 0.85±0.15 | *1, *2 |
| HMJ212KB7222□DHT | | | | X7R | 2200 p | ±10, ±20 | 2.5 | 200 | 0.85±0.15 | *1, *2 |
| HMJ212BB7472□GHT | | X7R | | 4700 p | ±10, ±20 | 2.5 | 200 | 1.25+0.20/-0 | *1, *2 | |
| HMJ212BB7103□GHT | | X7R | | 0.01 μ | ±10, ±20 | 2.5 | 200 | 1.25+0.20/-0 | *1, *2 | |
| HMJ212BB7223□GHT | | X7R | | 0.022 μ | ±10, ±20 | 3.5 | 200 | 1.25+0.20/-0 | *1, *2 | |
| HMJ212BB7473□GHT | | X7R | | 0.047 μ | ±10, ±20 | 3.5 | 200 | 1.25+0.20/-0 | *1, *2 | |
| HMJ212BB7104□GHT | | 250 | X7R | 0.1 μ | ±10, ±20 | 3.5 | 200 | 1.25+0.20/-0 | *1, *2 | |
| HMJ212BB7224□GHT | | | X7R | 0.22 μ | ±10, ±20 | 3.5 | 200 | 1.25+0.20/-0 | *1, *2 | |
| QMJ212KB7102□DHT | | | X7R | 1000 p | ±10, ±20 | 2.5 | 150 | 0.85±0.15 | *1, *2 | |
| QMJ212KB7222□DHT | | | X7R | 2200 p | ±10, ±20 | 2.5 | 150 | 0.85±0.15 | *1, *2 | |
| QMJ212BB7472□GHT | | | X7R | 4700 p | ±10, ±20 | 2.5 | 150 | 1.25+0.20/-0 | *1, *2 | |
| QMJ212BB7103□GHT | | | X7R | 0.01 μ | ±10, ±20 | 2.5 | 150 | 1.25+0.20/-0 | *1, *2 | |
| QMJ212BB7223□GHT | | X7R | 0.022 μ | ±10, ±20 | 2.5 | 150 | 1.25+0.20/-0 | *1, *2 | | |

● **316TYPE (Dimension:3.2×1.6mm JIS:3216 EIA:1206)**

[Temperature Characteristic B7 : X7R] 1.15mm thickness(F) , 1.6mm thickness(L)

| Part number 1 | Part number 2 | Rated voltage [V] | Temperature characteristics | Capacitance [F] | Capacitance tolerance [%] | tan δ [%] | HRTL | | Thickness*3 [mm] | Note |
|------------------|---------------|-------------------|-----------------------------|-----------------|---------------------------|-----------|-------------------|-----------|------------------|--------|
| | | | | | | | Rated voltage x % | | | |
| LMJ316BB7226□LHT | | 10 | X7R | 22 μ | ±10, ±20 | 10 | 150 | 1.6±0.30 | *1, *2 | |
| EMJ316BB7475□LHT | | 16 | X7R | 4.7 μ | ±10, ±20 | 10 | 150 | 1.6±0.30 | *1, *2 | |
| EMJ316BB7106□LHT | | | X7R | 10 μ | ±10, ±20 | 10 | 150 | 1.6±0.30 | *1, *2 | |
| TMJ316BB7474□LHT | | 25 | X7R | 0.47 μ | ±10, ±20 | 3.5 | 200 | 1.6±0.30 | *1, *2 | |
| TMJ316BB7475□LHT | | | X7R | 4.7 μ | ±10, ±20 | 10 | 150 | 1.6±0.30 | *1, *2 | |
| TMJ316BB7106□LHT | | | X7R | 10 μ | ±10, ±20 | 10 | 150 | 1.6±0.30 | *1, *2 | |
| GMJ316BB7474□LHT | | | X7R | 0.47 μ | ±10, ±20 | 3.5 | 200 | 1.6±0.30 | *1, *2 | |
| GMJ316AB7225□LHT | | | 35 | X7R | 2.2 μ | ±10, ±20 | 10 | 150 | 1.6±0.20 | *1, *2 |
| GMJ316BB7475□LHT | | | | X7R | 4.7 μ | ±10, ±20 | 10 | 150 | 1.6±0.30 | *1, *2 |
| GMJ316BB7106□LHT | | X7R | | 10 μ | ±10, ±20 | 10 | 150 | 1.6±0.30 | *1, *2 | |
| UMJ316BB7473□LHT | | X7R | | 0.047 μ | ±10, ±20 | 2.5 | 200 | 1.6±0.30 | *1, *2 | |
| UMJ316BB7104□LHT | | X7R | | 0.1 μ | ±10, ±20 | 3.5 | 200 | 1.6±0.30 | *1, *2 | |
| UMJ316BB7224□LHT | | 50 | | X7R | 0.22 μ | ±10, ±20 | 3.5 | 200 | 1.6±0.30 | *1, *2 |
| UMJ316BB7474□LHT | | | X7R | 0.47 μ | ±10, ±20 | 3.5 | 200 | 1.6±0.30 | *1, *2 | |
| UMJ316BB7105□LHT | | | X7R | 1 μ | ±10, ±20 | 3.5 | 200 | 1.6±0.30 | *1, *2 | |
| UMJ316AB7225□LHT | | | X7R | 2.2 μ | ±10, ±20 | 10 | 150 | 1.6±0.20 | *1, *2 | |
| HMJ316 B7102□FHT | | | 100 | X7R | 1000 p | ±10, ±20 | 2.5 | 200 | 1.15±0.10 | *1, *2 |
| HMJ316 B7222□FHT | | | | X7R | 2200 p | ±10, ±20 | 2.5 | 200 | 1.15±0.10 | *1, *2 |
| HMJ316 B7472□FHT | | X7R | | 4700 p | ±10, ±20 | 2.5 | 200 | 1.15±0.10 | *1, *2 | |
| HMJ316KB7103□FHT | | X7R | | 0.01 μ | ±10, ±20 | 2.5 | 200 | 1.15±0.20 | *1, *2 | |
| HMJ316BB7223□LHT | | X7R | | 0.022 μ | ±10, ±20 | 2.5 | 200 | 1.6±0.30 | *1, *2 | |
| HMJ316BB7473□LHT | | X7R | | 0.047 μ | ±10, ±20 | 2.5 | 200 | 1.6±0.30 | *1, *2 | |
| HMJ316BB7104□LHT | | 250 | X7R | 0.1 μ | ±10, ±20 | 2.5 | 200 | 1.6±0.30 | *1, *2 | |
| HMJ316BB7224□LHT | | | X7R | 0.22 μ | ±10, ±20 | 3.5 | 200 | 1.6±0.30 | *1, *2 | |
| HMJ316BB7474□LHT | | | X7R | 0.47 μ | ±10, ±20 | 3.5 | 200 | 1.6±0.30 | *1, *2 | |
| HMJ316BB7105□LHT | | | X7R | 1 μ | ±10, ±20 | 3.5 | 200 | 1.6±0.30 | *1, *2 | |

▶ This catalog contains the typical specification only due to the limitation of space. When you consider the purchase of our products, please check our specification. For details of each product (characteristics graph, reliability information, precautions for use, and so on), see our website (<http://www.ty-top.com/>).

■ PART NUMBER

| Part number 1 | Part number 2 | Rated voltage [V] | Temperature characteristics | Capacitance [F] | Capacitance tolerance [%] | tan δ [%] | HTLT | | Thickness*3 [mm] | Note |
|------------------|---------------|-------------------|-----------------------------|-----------------|---------------------------|-----------|-------------------|-----------|------------------|-------|
| | | | | | | | Rated voltage x % | | | |
| QMJ316 B7102□FHT | | 250 | X7R | 1000 p | ±10, ±20 | 2.5 | 150 | 1.15±0.10 | *1 *2 | |
| QMJ316 B7222□FHT | | | X7R | 2200 p | ±10, ±20 | 2.5 | 150 | 1.15±0.10 | *1 *2 | |
| QMJ316 B7472□FHT | | | X7R | 4700 p | ±10, ±20 | 2.5 | 150 | 1.15±0.10 | *1 *2 | |
| QMJ316KB7103□FHT | | | X7R | 0.01 μ | ±10, ±20 | 2.5 | 150 | 1.15±0.20 | *1 *2 | |
| QMJ316BB7223□LHT | | | X7R | 0.022 μ | ±10, ±20 | 2.5 | 150 | 1.6±0.30 | *1 *2 | |
| QMJ316BB7473□LHT | | | X7R | 0.047 μ | ±10, ±20 | 2.5 | 150 | 1.6±0.30 | *1 *2 | |
| QMJ316BB7104□LHT | | | X7R | 0.1 μ | ±10, ±20 | 2.5 | 150 | 1.6±0.30 | *1 *2 | |
| SMJ316 B7102□FHT | | | 630 | X7R | 1000 p | ±10, ±20 | 2.5 | 120 | 1.15±0.10 | *1 *2 |
| SMJ316 B7222□FHT | | | | X7R | 2200 p | ±10, ±20 | 2.5 | 120 | 1.15±0.10 | *1 *2 |
| SMJ316 B7472□FHT | | | | X7R | 4700 p | ±10, ±20 | 2.5 | 120 | 1.15±0.10 | *1 *2 |
| SMJ316KB7103□FHT | | X7R | | 0.01 μ | ±10, ±20 | 2.5 | 120 | 1.15±0.20 | *1 *2 | |
| SMJ316BB7223□LHT | | X7R | | 0.022 μ | ±10, ±20 | 2.5 | 120 | 1.6±0.30 | *1 *2 | |
| | | | | | | | | | | |

● 325TYPE (Dimension:3.2×2.5mm JIS:3225 EIA:1210)

[Temperature Characteristic B7 : X7R] 1.9mm thickness (N) , 2.5mm thickness (M)

| Part number 1 | Part number 2 | Rated voltage [V] | Temperature characteristics | Capacitance [F] | Capacitance tolerance [%] | tan δ [%] | HTLT | | Thickness*3 [mm] | Note |
|------------------|------------------|-------------------|-----------------------------|-----------------|---------------------------|-----------|-------------------|----------|------------------|-------|
| | | | | | | | Rated voltage x % | | | |
| JMJ325KB7476□MHP | JMJ325KB7476□MHT | 6.3 | X7R | 47 μ | ±10, ±20 | 10 | 150 | 2.5±0.30 | *1 *2 | |
| EMJ325KB7226□MHP | EMJ325KB7226□MHT | 16 | X7R | 22 μ | ±10, ±20 | 10 | 150 | 2.5±0.30 | *1 *2 | |
| TMJ325AB7475□MHP | TMJ325AB7475□MHT | 25 | X7R | 4.7 μ | ±10, ±20 | 2.5 | 150 | 2.5±0.30 | *1 *2 | |
| TMJ325KB7106□MHP | TMJ325KB7106□MHT | | X7R | 10 μ | ±10, ±20 | 10 | 150 | 2.5±0.30 | *1 *2 | |
| GMJ325AB7475□MHP | GMJ325AB7475□MHT | 35 | X7R | 4.7 μ | ±10, ±20 | 2.5 | 150 | 2.5±0.30 | *1 *2 | |
| GMJ325KB7106□MHP | GMJ325KB7106□MHT | | X7R | 10 μ | ±10, ±20 | 10 | 150 | 2.5±0.30 | *1 *2 | |
| UMJ325AB7225□MHP | UMJ325AB7225□MHT | 50 | X7R | 2.2 μ | ±10, ±20 | 3.5 | 200 | 2.5±0.30 | *1 *2 | |
| UMJ325AB7475□MHP | UMJ325AB7475□MHT | | X7R | 4.7 μ | ±10, ±20 | 2.5 | 150 | 2.5±0.30 | *1 *2 | |
| UMJ325KB7106□MHP | UMJ325KB7106□MHT | | X7R | 10 μ | ±10, ±20 | 10 | 150 | 2.5±0.30 | *1 *2 | |
| HMJ325 B7223□NHT | | | 100 | X7R | 0.022 μ | ±10, ±20 | 2.5 | 200 | 1.9±0.20 | *1 *2 |
| HMJ325 B7473□NHT | | | | X7R | 0.047 μ | ±10, ±20 | 2.5 | 200 | 1.9±0.20 | *1 *2 |
| HMJ325 B7104□NHT | | | | X7R | 0.1 μ | ±10, ±20 | 2.5 | 200 | 1.9±0.20 | *1 *2 |
| HMJ325 B7224□NHT | | X7R | | 0.22 μ | ±10, ±20 | 2.5 | 200 | 1.9±0.20 | *1 *2 | |
| HMJ325 B7474□NHT | | X7R | | 0.47 μ | ±10, ±20 | 3.5 | 200 | 1.9±0.20 | *1 *2 | |
| HMJ325 B7105□NHT | | X7R | | 1 μ | ±10, ±20 | 3.5 | 200 | 1.9±0.20 | *1 *2 | |
| HMJ325AB7225□MHP | HMJ325AB7225□MHT | X7R | | 2.2 μ | ±10, ±20 | 3.5 | 200 | 2.5±0.30 | *1 *2 | |
| QMJ325 B7223□NHT | | 250 | | X7R | 0.022 μ | ±10, ±20 | 2.5 | 150 | 1.9±0.20 | *1 *2 |
| QMJ325 B7473□NHT | | | X7R | 0.047 μ | ±10, ±20 | 2.5 | 150 | 1.9±0.20 | *1 *2 | |
| QMJ325 B7104□NHT | | | X7R | 0.1 μ | ±10, ±20 | 2.5 | 150 | 1.9±0.20 | *1 *2 | |
| QMJ325 B7224□NHT | | | X7R | 0.22 μ | ±10, ±20 | 2.5 | 150 | 1.9±0.20 | *1 *2 | |
| SMJ325 B7223□NHT | | 630 | X7R | 0.022 μ | ±10, ±20 | 2.5 | 120 | 1.9±0.20 | *1 *2 | |
| SMJ325 B7473□NHT | | | X7R | 0.047 μ | ±10, ±20 | 2.5 | 120 | 1.9±0.20 | *1 *2 | |

LW Reversal Decoupling Capacitors (LWDC™)

● 105TYPE (Dimension:0.52×1.0mm JIS:0510 EIA:0204)

[Temperature Characteristic BJ : X5R] 0.3mm thickness (P)

| Part number 1 | Part number 2 | Rated voltage [V] | Temperature characteristics | Capacitance [F] | Capacitance tolerance [%] | tan δ [%] | HTLT | | Thickness*3 [mm] | Note |
|------------------|---------------|-------------------|-----------------------------|-----------------|---------------------------|-----------|-------------------|----------|------------------|------|
| | | | | | | | Rated voltage x % | | | |
| TWK105 BJ104MPHF | | 25 | X5R | 0.1 μ | ±20 | 5 | 150 | 0.3±0.05 | *1 *2 | |
| EWK105 BJ224MPHF | | 16 | X5R | 0.22 μ | ±20 | 10 | 150 | 0.3±0.05 | *1 *2 | |
| LWK105 BJ474MPHF | | 10 | X5R | 0.47 μ | ±20 | 10 | 150 | 0.3±0.05 | *1 *2 | |
| AWK105 BJ105MPHF | | 4 | X5R | 1 μ | ±20 | 10 | 150 | 0.3±0.05 | *1 *2 | |

[Temperature Characteristic C6 : X6S , C7 : X7S] 0.3mm thickness (P)

| Part number 1 | Part number 2 | Rated voltage [V] | Temperature characteristics | Capacitance [F] | Capacitance tolerance [%] | tan δ [%] | HTLT | | Thickness*3 [mm] | Note |
|------------------|---------------|-------------------|-----------------------------|-----------------|---------------------------|-----------|-------------------|----------|------------------|-------|
| | | | | | | | Rated voltage x % | | | |
| EWK105 C6104MPHF | | 16 | X6S | 0.1 μ | ±20 | 5 | 150 | 0.3±0.05 | *1 *2 | |
| LWK105 C7104MPHF | | 10 | X7S | 0.1 μ | ±20 | 5 | 150 | 0.3±0.05 | *1 *2 | |
| LWK105 C6224MPHF | | | X6S | 0.22 μ | ±20 | 10 | 150 | 0.3±0.05 | *1 *2 | |
| JWK105 C7104MPHF | | 6.3 | X7S | 0.1 μ | ±20 | 5 | 150 | 0.3±0.05 | *1 *2 | |
| JWK105 C7224MPHF | | | X7S | 0.22 μ | ±20 | 10 | 150 | 0.3±0.05 | *1 *2 | |
| JWK105 C6474MPHF | | | X6S | 0.47 μ | ±20 | 10 | 150 | 0.3±0.05 | *1 *2 | |
| AWK105 C7224MPHF | | | 4 | X7S | 0.22 μ | ±20 | 10 | 150 | 0.3±0.05 | *1 *2 |
| AWK105 C6474MPHF | | X6S | | 0.47 μ | ±20 | 10 | 150 | 0.3±0.05 | *1 *2 | |

● 107TYPE (Dimension:0.8×1.6mm JIS:0816 EIA:0306)

[Temperature Characteristic BJ : X5R] 0.5mm thickness (V)

| Part number 1 | Part number 2 | Rated voltage [V] | Temperature characteristics | Capacitance [F] | Capacitance tolerance [%] | tan δ [%] | HTLT | | Thickness*3 [mm] | Note |
|------------------|---------------|-------------------|-----------------------------|-----------------|---------------------------|-----------|-------------------|----------|------------------|------|
| | | | | | | | Rated voltage x % | | | |
| LWK107 BJ105MVHT | | 10 | X5R | 1 μ | ±20 | 10 | 150 | 0.5±0.05 | *1 *2 | |
| JWK107 BJ225MVHT | | 6.3 | X5R | 2.2 μ | ±20 | 10 | 150 | 0.5±0.05 | *1 *2 | |
| JWK107 BJ475MVHT | | | X5R | 4.7 μ | ±20 | 10 | 150 | 0.5±0.05 | *1 *2 | |

[Temperature Characteristic B7 : X7R , C6 : X6S , C7 : X7S] 0.5mm thickness (V)

| Part number 1 | Part number 2 | Rated voltage [V] | Temperature characteristics | Capacitance [F] | Capacitance tolerance [%] | tan δ [%] | HTLT | | Thickness*3 [mm] | Note |
|------------------|---------------|-------------------|-----------------------------|-----------------|---------------------------|-----------|-------------------|----------|------------------|------|
| | | | | | | | Rated voltage x % | | | |
| TWK107 B7104MVHT | | 25 | X7R | 0.1 μ | ±20 | 5 | 150 | 0.5±0.05 | *1 *2 | |
| EWK107 B7224MVHT | | 16 | X7R | 0.22 μ | ±20 | 5 | 150 | 0.5±0.05 | *1 *2 | |
| EWK107 B7474MVHT | | | X7R | 0.47 μ | ±20 | 5 | 150 | 0.5±0.05 | *1 *2 | |
| LWK107 B7474MVHT | | 10 | X7R | 0.47 μ | ±20 | 5 | 150 | 0.5±0.05 | *1 *2 | |
| JWK107 C7105MVHT | | 6.3 | X7S | 1 μ | ±20 | 10 | 150 | 0.5±0.05 | *1 *2 | |
| AWK107 C6225MVHT | | | X6S | 2.2 μ | ±20 | 10 | 150 | 0.5±0.05 | *1 *2 | |
| AWK107 C6475MVHT | | 4 | X6S | 4.7 μ | ±20 | 10 | 150 | 0.5±0.05 | *1 *2 | |

▶ This catalog contains the typical specification only due to the limitation of space. When you consider the purchase of our products, please check our specification. For details of each product (characteristics graph, reliability information, precautions for use, and so on), see our website (<http://www.ty-top.com/>).

Multilayer Ceramic Capacitors

PACKAGING

① Minimum Quantity

● Taped package

| Type(EIA) | Thickness | | Standard quantity [pcs] | |
|------------------------------|-----------|------|-------------------------|-----------------|
| | mm | code | Paper tape | Embossed tape |
| □MK021(008004) | 0.125 | K | — | 50000 |
| □MK042(01005) | 0.2 | C, D | — | 40000 |
| □VS042(01005) | 0.2 | C | | |
| □MK063(0201) | 0.3 | P, T | 15000 | — |
| □WK105(0204) ※ | 0.3 | P | 10000 | — |
| □MK105(0402) | 0.13 | H | — | 20000 |
| | 0.18 | E | — | 15000 |
| | 0.2 | C | 20000 | — |
| | 0.3 | P | 15000 | — |
| | 0.5 | V | 10000 | — |
| □VK105(0402) | 0.5 | W | 10000 | — |
| □MK107(0603) | 0.45 | K | 4000 | — |
| □WK107(0306) ※ | 0.5 | V | — | 4000 |
| □MR107(0603) | 0.8 | A | 4000 | — |
| □VS107(0603) | 0.7 | C | 4000 | — |
| □MJ107(0603) | 0.8 | A | 3000 | 3000 |
| □MK212(0805) | 0.45 | K | 4000 | — |
| □WK212(0508) ※ | 0.85 | D | | |
| □MR212(0805) | 1.25 | G | — | 3000 |
| □VS212(0805) | 0.85 | D | 4000 | — |
| □MJ212(0805) | 0.85 | D | 4000 | — |
| | 1.25 | G | — | 2000 |
| □MK316(1206) | 0.85 | D | 4000 | — |
| □MR316(1206) | 1.15 | F | — | 3000 |
| | 1.6 | L | — | 2000 |
| □MJ316(1206) | 1.15 | F | — | 3000 |
| | 1.6 | L | — | 2000 |
| □MK325(1210) □MR325(1210) | 0.85 | D | — | 2000 |
| | 1.15 | F | | |
| | 1.9 | N | | |
| | 2.0max. | Y | | |
| □MJ325(1210) | 1.9 | N | — | 2000 |
| | 2.5 | M | — | 500(T), 1000(P) |
| □MK432(1812) | 2.5 | M | — | 500 |

Note : ※ LW Reverse type.

② Taping material

※No bottom tape for pressed carrier tape

● Card board carrier tape

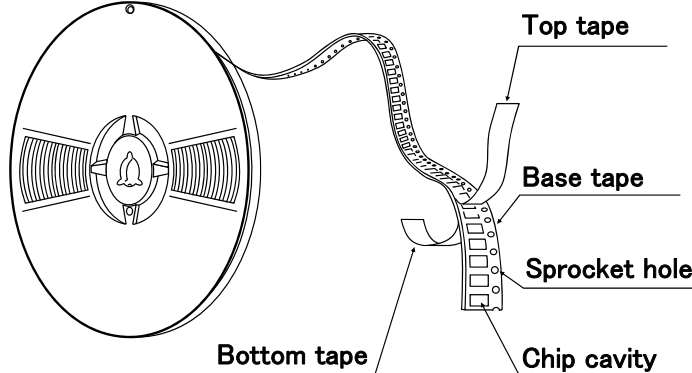

● Embossed tape

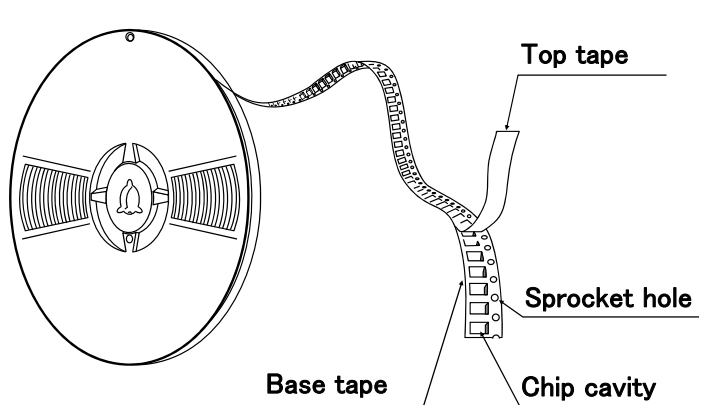

▶ This catalog contains the typical specification only due to the limitation of space. When you consider the purchase of our products, please check our specification. For details of each product (characteristics graph, reliability information, precautions for use, and so on), see our Web site (<http://www.ty-top.com/>).

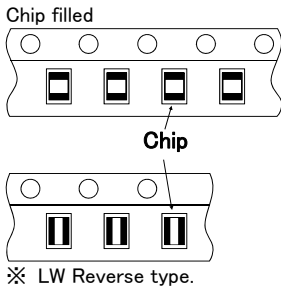

③ Representative taping dimensions

● Paper Tape (8mm wide)

● Pressed carrier tape (2mm pitch)

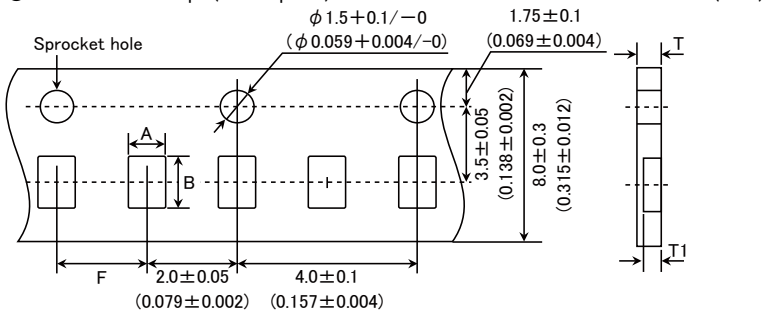

| Type(EIA) | Chip Cavity | | Insertion Pitch F | Tape Thickness | |
|---------------------|-------------|------|----------------------|----------------|----------|
| | A | B | | T | T1 |
| □MK063(0201) | 0.37 | 0.67 | 2.0±0.05 | 0.45max. | 0.42max. |
| □WK105(0204) ※ | 0.65 | 1.15 | | 0.4max. | 0.3max. |
| □MK105(0402) (*1 C) | | | | 0.45max. | 0.42max. |
| □MK105(0402) (*1 P) | | | | | |

Note *1 Thickness, C: 0.2mm ,P: 0.3mm. ※ LW Reverse type.

Unit: mm

● Punched carrier tape (2mm pitch)

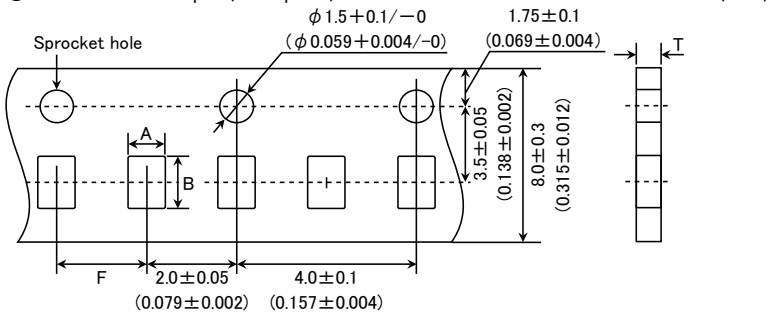

| Type(EIA) | Chip Cavity | | Insertion Pitch F | Tape Thickness |
|---------------|-------------|------|----------------------|----------------|
| | A | B | | T |
| □MK105 (0402) | 0.65 | 1.15 | 2.0±0.05 | 0.8max. |
| □VK105 (0402) | | | | |

Unit: mm

● Punched carrier tape (4mm pitch)

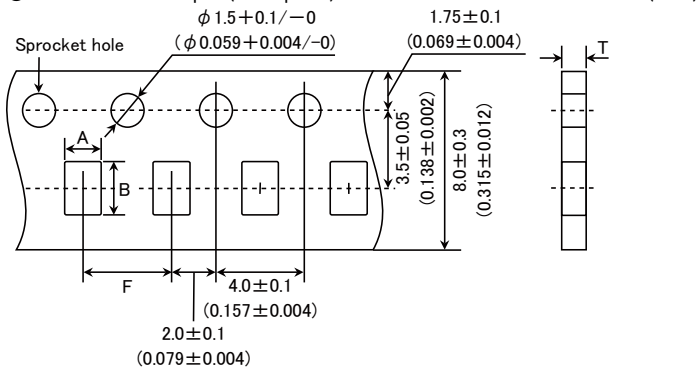

▶ This catalog contains the typical specification only due to the limitation of space. When you consider the purchase of our products, please check our specification. For details of each product (characteristics graph, reliability information, precautions for use, and so on), see our Web site (<http://www.ty-top.com/>).

| Type(EIA) | Chip Cavity | | Insertion Pitch | Tape Thickness |
|--|-------------|-----|-----------------|----------------|
| | A | B | F | T |
| □MK107(0603) □WK107(0306) ※ □MR107(0603) | 1.0 | 1.8 | 4.0±0.1 | 1.1max. |
| □MK212(0805) □WK212(0508) ※ □MK316(1206) | 1.65 | 2.4 | | 1.1max. |
| | 2.0 | 3.6 | | |

Note: Taping size might be different depending on the size of the product. ※ LW Reverse type.

Unit: mm

● Embossed tape (4mm wide)

Unit: mm (inch)

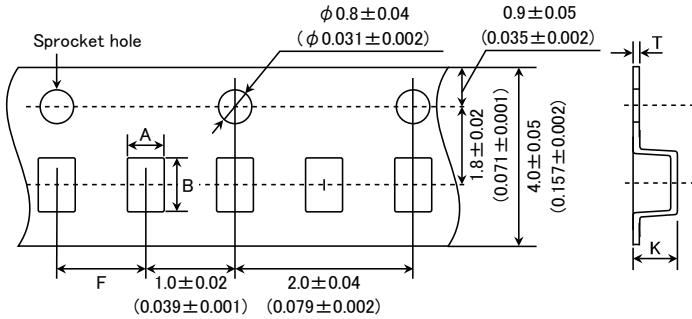

| Type(EIA) | Chip Cavity | | Insertion Pitch | Tape Thickness | |
|---------------------------------|-------------|------|-----------------|----------------|----------|
| | A | B | F | K | T |
| □MK021(008004) □MK042(01005) | 0.135 | 0.27 | 1.0±0.02 | 0.5max. | 0.25max. |
| □VS042(01005) | 0.23 | 0.43 | | | |

Unit: mm

● Embossed tape (8mm wide)

Unit: mm (inch)

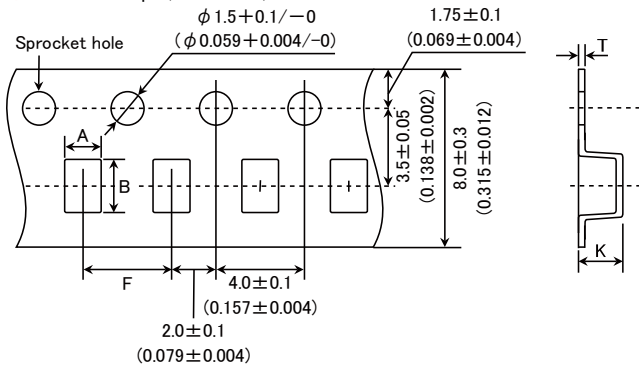

| Type(EIA) | Chip Cavity | | Insertion Pitch | Tape Thickness | |
|--|-------------|-----|-----------------|----------------|---------|
| | A | B | F | K | T |
| □MK105(0402) □WK107(0306) ※ □MK212(0805) □MR212(0805) | 0.6 | 1.1 | 2.0±0.1 | 0.6max | 0.2±0.1 |
| □MK316(1206) □MR316(1206) | 2.0 | 3.6 | 4.0±0.1 | 3.4max. | 0.6max. |
| □MK325(1210) □MR325(1210) | 2.8 | 3.6 | | | |
| | | | | | |

Note: ※ LW Reverse type.

Unit: mm

● Embossed tape (12mm wide) Unit: mm (inch)

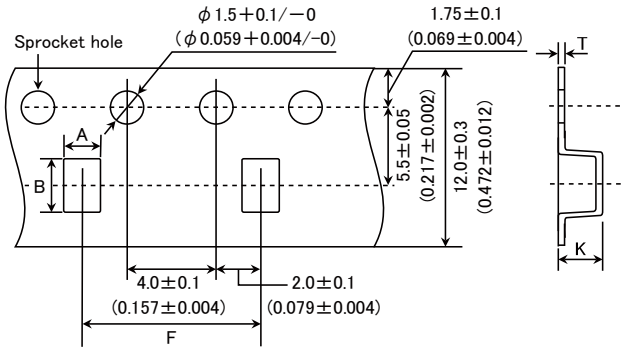

| Type(EIA) | Chip Cavity | | Insertion Pitch | Tape Thickness | |
|--------------|-------------|-----|-----------------|----------------|---------|
| | A | B | | K | T |
| □MK325(1210) | 3.1 | 4.0 | 8.0±0.1 | 4.0max. | 0.6max. |
| □MK432(1812) | 3.7 | 4.9 | 8.0±0.1 | 4.0max. | 0.6max. |

Unit: mm

④Trailer and Leader

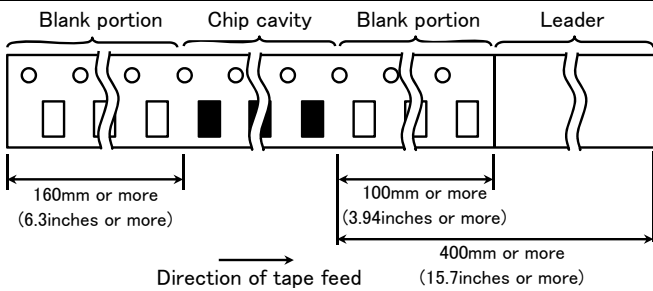

⑤Reel size

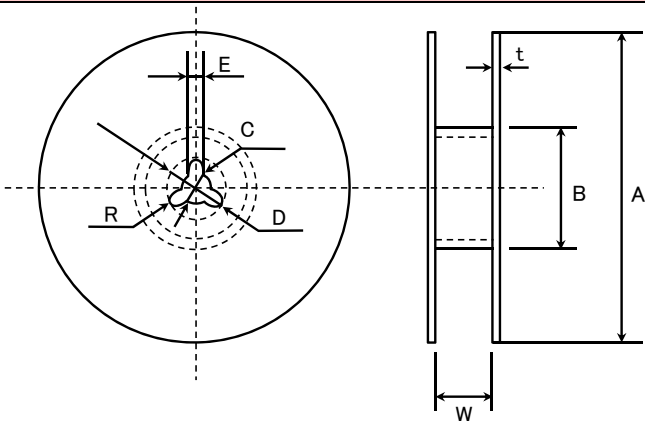

| A | B | C | D | E | R |
|----------------|---------|-----------|-----------|---------|-----|
| φ178±2.0 | φ50min. | φ13.0±0.2 | φ21.0±0.8 | 2.0±0.5 | 1.0 |
| | T | W | | | |
| 4mm wide tape | 1.5max. | 5±1.0 | | | |
| 8mm wide tape | 2.5max. | 10±1.5 | | | |
| 12mm wide tape | 2.5max. | 14±1.5 | | | |

Unit: mm

⑥Top Tape Strength

The top tape requires a peel-off force of 0.1 to 0.7N in the direction of the arrow as illustrated below.

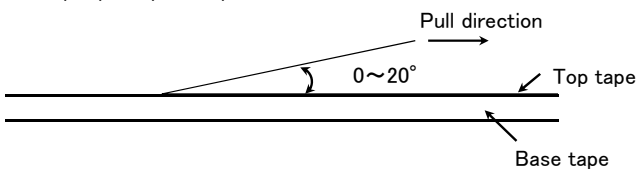

▶ This catalog contains the typical specification only due to the limitation of space. When you consider the purchase of our products, please check our specification. For details of each product (characteristics graph, reliability information, precautions for use, and so on), see our Web site (<http://www.ty-top.com/>).

Multilayer Ceramic Capacitors

RELIABILITY DATA

1. Operating Temperature Range

| | | | | |
|-----------------|-----------------------------------|---------------------|---------------|---------------|
| Specified Value | Temperature Compensating (Class1) | Standard | -55 to +125°C | |
| | | High Frequency Type | | |
| Specified Value | High Permittivity (Class2) | | | |
| | | BJ | B | -25 to +85°C |
| | | | X5R | -55 to +85°C |
| | | B7 | X7R | -55 to +125°C |
| | | C6 | X6S | -55 to +105°C |
| | | C7 | X7S | -55 to +125°C |
| | | D7 | X7T | -55 to +125°C |
| | | LD(※) | X5R | -55 to +85°C |

Note: ※LD Low distortion high value multilayer ceramic capacitor

2. Storage Conditions

| | | | | |
|-----------------|-----------------------------------|---------------------|---------------|---------------|
| Specified Value | Temperature Compensating (Class1) | Standard | -55 to +125°C | |
| | | High Frequency Type | | |
| Specified Value | High Permittivity (Class2) | | | |
| | | BJ | B | -25 to +85°C |
| | | | X5R | -55 to +85°C |
| | | B7 | X7R | -55 to +125°C |
| | | C6 | X6S | -55 to +105°C |
| | | C7 | X7S | -55 to +125°C |
| | | D7 | X7T | -55 to +125°C |
| | | LD(※) | X5R | -55 to +85°C |

Note: ※LD Low distortion high value multilayer ceramic capacitor

3. Rated Voltage

| | | | |
|-----------------|-----------------------------------|---------------------|---|
| Specified Value | Temperature Compensating (Class1) | Standard | 50VDC, 25VDC |
| | | High Frequency Type | 50VDC, 25VDC |
| | High Permittivity (Class2) | | 50VDC, 35VDC, 25VDC, 16VDC, 10VDC, 6.3VDC, 4VDC, 2.5VDC |

4. Withstanding Voltage (Between terminals)

| | | | |
|--------------------------|-----------------------------------|---------------------|------------------------|
| Specified Value | Temperature Compensating (Class1) | Standard | No breakdown or damage |
| | | High Frequency Type | |
| Test Methods and Remarks | High Permittivity (Class2) | | |
| | | Class 1 | Class 2 |
| | Applied voltage | Rated volta × 3 | Rated voltage × 2.5 |
| | Duration | 1 to 5 sec. | |
| | Charge/discharge current | 50mA max. | |

5. Insulation Resistance

| | | | |
|-----------------|-----------------------------------|---------------------|---|
| Specified Value | Temperature Compensating (Class1) | Standard | 10000 MΩ min. |
| | | High Frequency Type | |
| Specified Value | High Permittivity (Class2) Note 1 | | C ≤ 0.047 μF : 10000 MΩ min. C > 0.047 μF : 500MΩ · μF |
| | Test Methods and Remarks | Applied voltage | : Rated voltage |
| | Duration | : 60 ± 5 sec. | |
| | Charge/discharge current | : 50mA max. | |

6. Capacitance (Tolerance)

| | | | | | |
|----------------------------|----------------------------------|----------|--|------------------|-----------|
| Specified Value | Temperature Compensating(Class1) | Standard | C□ | 0.2pF ≤ C ≤ 5pF | : ±0.25pF |
| | | | U□ | 0.2pF ≤ C ≤ 10pF | : ±0.5pF |
| | SL | C > 10pF | : ±5% or ±10% | | |
| High Permittivity (Class2) | High Frequency Type | CH | 0.3pF ≤ C ≤ 2pF | : ±0.1pF | |
| | | | C > 2pF | : ±5% | |
| | | | BJ, B7, C6, C7, D7, LD(※): ±10% or ±20% | | |
| | | | Note: ※LD Low distortion high value multilayer ceramic capacitor | | |

7. Q or Dissipation Factor

| | | | | | |
|-------------------------------|-----------------------------------|---------------------|--|--|--|
| Specified Value | Temperature Compensating(Class1) | Standard | C < 30pF : Q ≥ 400 + 20C | | |
| | | | C ≥ 30pF : Q ≥ 1000 (C: Nominal capacitance) | | |
| | High Permittivity (Class2) Note 1 | High Frequency Type | Refer to detailed specification | | |
| BJ, B7, C6, C7, D7: 2.5% max. | | | | | |

| | | | | | |
|--------------------------|--------------------------|--------------|---------------------|---|--------------|
| Test Methods and Remarks | | Class 1 | | Class 2 | |
| | | Standard | High Frequency Type | C ≤ 10 μF | C > 10 μF |
| | Preconditioning | None | | Thermal treatment (at 150°C for 1hr) Note 2 | |
| | Measuring frequency | 1MHz ± 10% | | 1kHz ± 10% | 120 ± 10Hz |
| | Measuring voltage Note 1 | 0.5 to 5Vrms | | 1 ± 0.2Vrms | 0.5 ± 0.1rms |
| | Bias application | one | | | |

| | | | | | |
|--------------------------|--------------------------|--------------|---------------------|---|---------------|
| Test Methods and Remarks | | Class 1 | | Class 2 | |
| | | Standard | High Frequency Type | C ≤ 10 μF | C > 10 μF |
| | Preconditioning | None | | Thermal treatment (at 150°C for 1hr) Note 2 | |
| | Measuring frequency | 1MHz ± 10% | 1GHz | 1kHz ± 10% | 120 ± 10Hz |
| | Measuring voltage Note 1 | 0.5 to 5Vrms | | 1 ± 0.2Vrms | 0.5 ± 0.1Vrms |
| | Bias application | None | | | |

High Frequency Type
 Measuring equipment : HP4291A
 Measuring jig : HP16192A

8. Temperature Characteristic (Without voltage application)

| | | | | | | |
|----------------------------|----------------------------------|----------|-------------------------------------|----------------|--------------------|----------|
| Specified Value | Temperature Compensating(Class1) | Standard | Temperature Characteristic [ppm/°C] | | Tolerance [ppm/°C] | |
| | | | C□ : 0 | CG, CH, CJ, CK | G : ±30 | H : ±60 |
| | | | U□ : -750 | UJ, UK | J : ±120 | K : ±250 |
| High Permittivity (Class2) | High Frequency Type | CH | Temperature Characteristic [ppm/°C] | | Tolerance [ppm/°C] | |
| | | | C□ : 0 | CH | H : ±60 | |
| | | | | | | |

| | Specification | Capacitance change | Reference temperature | Temperature Range |
|-------|---------------|--------------------|-----------------------|-------------------|
| BJ | B | ±10% | 20°C | -25 to +85°C |
| | X5R | ±15% | 25°C | -55 to +85°C |
| B7 | X7R | ±15% | 25°C | -55 to +125°C |
| C6 | X6S | ±22% | 25°C | -55 to +105°C |
| C7 | X7S | ±22% | 25°C | -55 to +125°C |
| D7 | X7S | +22/-33% | 25°C | -55 to +125°C |
| LD(※) | X5R | ±15% | 25°C | -55 to +85°C |

Note : ※LD Low distortion high value multilayer ceramic capacitor

| | | | | |
|--------------------------|--|--|-----------------|--|
| Test Methods and Remarks | Class 1 | Capacitance at 20°C and 85°C shall be measured in thermal equilibrium, and the temperature characteristic shall be calculated from the following equation. | | |
| | | $\frac{(C_{85} - C_{20})}{C_{20} \times \Delta T} \times 10^6 \text{ (ppm/°C)}$ | $\Delta T = 65$ | |
| Class 2 | Capacitance at each step shall be measured in thermal equilibrium, and the temperature characteristic shall be calculated from the following equation. | | | |
| | | | | |

| Step | B | X5R, X7R, X6S, X7S, X7T |
|------|-------------------------------|-------------------------|
| 1 | Minimum operating temperature | |
| 2 | 20°C | 25°C |
| 3 | Maximum operating temperature | |

| | |
|--|--|
| | $\frac{(C-C_2)}{C_2} \times 100(\%)$ <p>C : Capacitance in Step 1 or Step 3 C2 : Capacitance in Step 2</p> |
|--|--|

9. Deflection

| | | | |
|-----------------|----------------------------------|---------------------|---|
| Specified Value | Temperature Compensating(Class1) | Standard | Appearance : No abnormality Capacitance change : Within $\pm 5\%$ or ± 0.5 pF, whichever is larger. |
| | | High Frequency Type | Appearance : No abnormality Capacitance change : Within ± 0.5 pF |
| | High Permittivity (Class2) | | Appearance : No abnormality Capacitance change : Within $\pm 12.5\%$ (BJ, B7, C6, C7, D7, LD(※)) Note: ※LD Low distortion high value multilayer ceramic capacitor |

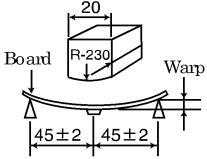
| Test Methods and Remarks | <table border="1"> <tr> <th colspan="2">Multilayer Ceramic Capacitors</th> </tr> <tr> <td>042, 063, ※105 Type</td> <td>The other types</td> </tr> <tr> <td colspan="2">Board</td> </tr> <tr> <td colspan="2">Glass epoxy-resin substrate</td> </tr> <tr> <td>Thickness</td> <td>0.8mm / 1.6mm</td> </tr> <tr> <td>Warp</td> <td>1mm (Soft Termination type:3mm)</td> </tr> <tr> <td>Duration</td> <td>10 sec.</td> </tr> </table> | | Multilayer Ceramic Capacitors | | 042, 063, ※105 Type | The other types | Board | | Glass epoxy-resin substrate | | Thickness | 0.8mm / 1.6mm | Warp | 1mm (Soft Termination type:3mm) | Duration | 10 sec. |  <p>(Unit: mm)</p> <p>Capacitance measurement shall be conducted with the board bent</p> |
|--|---|--|-------------------------------|--|---------------------|-----------------|-------|--|-----------------------------|--|-----------|---------------|------|---------------------------------|----------|---------|---|
| | Multilayer Ceramic Capacitors | | | | | | | | | | | | | | | | |
| 042, 063, ※105 Type | The other types | | | | | | | | | | | | | | | | |
| Board | | | | | | | | | | | | | | | | | |
| Glass epoxy-resin substrate | | | | | | | | | | | | | | | | | |
| Thickness | 0.8mm / 1.6mm | | | | | | | | | | | | | | | | |
| Warp | 1mm (Soft Termination type:3mm) | | | | | | | | | | | | | | | | |
| Duration | 10 sec. | | | | | | | | | | | | | | | | |
| <p>※1: 105 Type thickness, C: 0.2mm, P: 0.3mm.</p> | | | | | | | | | | | | | | | | | |

10. Body Strength

| | | | |
|-----------------|----------------------------------|---------------------|-----------------------|
| Specified Value | Temperature Compensating(Class1) | Standard | — |
| | | High Frequency Type | No mechanical damage. |
| | High Permittivity (Class2) | | — |

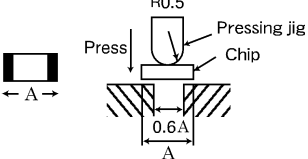
| | |
|--------------------------|--|
| Test Methods and Remarks | <p>High Frequency Type Applied force : 5N Duration : 10 sec.</p>  |
|--------------------------|--|

11. Adhesive Strength of Terminal Electrodes

| | | | |
|-----------------|----------------------------------|---------------------|---|
| Specified Value | Temperature Compensating(Class1) | Standard | No terminal separation or its indication. |
| | | High Frequency Type | |
| | High Permittivity (Class2) | | |

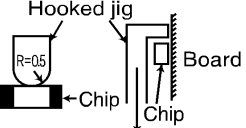
| Test Methods and Remarks | <table border="1"> <tr> <th colspan="2">Multilayer Ceramic Capacitors</th> </tr> <tr> <td>042, 063 Type</td> <td>105 Type or more</td> </tr> <tr> <td>Applied force</td> <td>2N / 5N</td> </tr> <tr> <td>Duration</td> <td>30±5 sec.</td> </tr> </table> | | Multilayer Ceramic Capacitors | | 042, 063 Type | 105 Type or more | Applied force | 2N / 5N | Duration | 30±5 sec. |  |
|--------------------------|--|------------------|-------------------------------|--|---------------|------------------|---------------|---------|----------|-----------|--|
| | Multilayer Ceramic Capacitors | | | | | | | | | | |
| | 042, 063 Type | 105 Type or more | | | | | | | | | |
| Applied force | 2N / 5N | | | | | | | | | | |
| Duration | 30±5 sec. | | | | | | | | | | |
| | | | | | | | | | | | |
| | | | | | | | | | | | |

12. Solderability

| | | | |
|-----------------|----------------------------------|---------------------|--|
| Specified Value | Temperature Compensating(Class1) | Standard | At least 95% of terminal electrode is covered by new solder. |
| | | High Frequency Type | |
| | High Permittivity (Class2) | | |

| | | | |
|--------------------------|--------------------|-----------------|------------------|
| Test Methods and Remarks | | Eutectic solder | Lead-free solder |
| | Solder type | H60A or H63A | Sn-3.0Ag-0.5Cu |
| | Solder temperature | 230±5°C | 245±3°C |
| | Duration | 4±1 sec. | |

▶ This catalog contains the typical specification only due to the limitation of space. When you consider the purchase of our products, please check our specification. For details of each product (characteristics graph, reliability information, precautions for use, and so on), see our Web site (<http://www.ty-top.com/>).

13. Resistance to Soldering

| | | | |
|-----------------|-----------------------------------|---------------------|--|
| Specified Value | Temperature Compensating(Class1) | Standard | Appearance : No abnormality Capacitance change : Within $\pm 2.5\%$ or $\pm 0.25\text{pF}$, whichever is larger. Q : Initial value Insulation resistance : Initial value Withstanding voltage (between terminals) : No abnormality |
| | | High Frequency Type | Appearance : No abnormality Capacitance change : Within $\pm 2.5\%$ Q : Initial value Insulation resistance : Initial value Withstanding voltage (between terminals) : No abnormality |
| | High Permittivity (Class2) Note 1 | | Appearance : No abnormality Capacitance change : Within $\pm 7.5\%$ (BJ, B7, C6, C7, D7, LD(※)) Dissipation factor : Initial value Insulation resistance : Initial value Withstanding voltage (between terminals) : No abnormality Note: ※LD Low distortion high value multilayer ceramic capacitor |

| | | | | |
|--------------------------|-----------------|--|---|---|
| Test Methods and Remarks | Class 1 | | | |
| | | 042, 063 Type | 105 Type | |
| | Preconditioning | None | | |
| | Preheating | 150°C, 1 to 2 min. | 80 to 100°C, 2 to 5 min. 150 to 200°C, 2 to 5 min. | |
| | Solder temp. | 270 \pm 5°C | | |
| | Duration | 3 \pm 0.5 sec. | | |
| | Recovery | 6 to 24 hrs (Standard condition) Note 5 | | |
| | Class 2 | | | |
| | | 042, 063 Type | 105, 107, 212 Type | 316, 325 Type |
| | Preconditioning | Thermal treatment (at 150°C for 1 hr) Note 2 | | |
| | Preheating | 150°C, 1 to 2 min. | 80 to 100°C, 2 to 5 min. 150 to 200°C, 2 to 5 min. | 80 to 100°C, 5 to 10 min. 150 to 200°C, 5 to 10 min. |
| | Solder temp. | 270 \pm 5°C | | |
| | Duration | 3 \pm 0.5 sec. | | |
| | Recovery | 24 \pm 2 hrs (Standard condition) Note 5 | | |

14. Temperature Cycle (Thermal Shock)

| | | | |
|-----------------|-----------------------------------|---------------------|--|
| Specified Value | Temperature Compensating(Class1) | Standard | Appearance : No abnormality Capacitance change : Within $\pm 2.5\%$ or $\pm 0.25\text{pF}$, whichever is larger. Q : Initial value Insulation resistance : Initial value Withstanding voltage (between terminals) : No abnormality |
| | | High Frequency Type | Appearance : No abnormality Capacitance change : Within $\pm 0.25\text{pF}$ Q : Initial value Insulation resistance : Initial value Withstanding voltage (between terminals) : No abnormality |
| | High Permittivity (Class2) Note 1 | | Appearance : No abnormality Capacitance change : Within $\pm 7.5\%$ (BJ, B7, C6, C7, D7, LD(※)) Dissipation factor : Initial value Insulation resistance : Initial value Withstanding voltage (between terminals) : No abnormality Note: ※LD Low distortion high value multilayer ceramic capacitor |

| | | | | |
|--------------------------|---|--|---|-------------|
| Test Methods and Remarks | Class 1 | | Class 2 | |
| | Preconditioning | None | Thermal treatment (at 150°C for 1 hr) Note 2 | |
| | 1 cycle | Step | Temperature (°C) | Time (min.) |
| | | 1 | Minimum operating temperature | 30 \pm 3 |
| | | 2 | Normal temperature | 2 to 3 |
| | | 3 | Maximum operating temperature | 30 \pm 3 |
| 4 | Normal temperature | 2 to 3 | | |
| Number of cycles | 5 times | | | |
| Recovery | 6 to 24 hrs (Standard condition) Note 5 | 24 \pm 2 hrs (Standard condition) Note 5 | | |

▶ This catalog contains the typical specification only due to the limitation of space. When you consider the purchase of our products, please check our specification.
 For details of each product (characteristics graph, reliability information, precautions for use, and so on), see our Web site (<http://www.ty-top.com/>).

| 15. Humidity (Steady State) | | | | | |
|-----------------------------|-----------------------------------|---|---|--|---|
| Specified Value | Temperature Compensating(Class1) | Standard | Appearance : No abnormality Capacitance change : Within $\pm 5\%$ or $\pm 0.5\text{pF}$, whichever is larger. Q : $C < 10\text{pF} : Q \geq 200 + 10C$ $10 \leq C < 30\text{pF} : Q \geq 275 + 2.5C$ $C \geq 30\text{pF} : Q \geq 350 (C : \text{Nominal capacitance})$ Insulation resistance : $1000 \text{ M}\Omega$ min. | | |
| | | High Frequency Type | Appearance : No abnormality Capacitance change : Within $\pm 0.5\text{pF}$, Insulation resistance : $1000 \text{ M}\Omega$ min. | | |
| | High Permittivity (Class2) Note 1 | | Appearance : No abnormality Capacitance change : Within $\pm 12.5\%$ (BJ, B7, C6, C7, D7, LD(※)) Dissipation factor : 5.0% max. (BJ, B7, C6, C7, D7, LD(※)) Insulation resistance : $50 \text{ M}\Omega \mu\text{F}$ or $1000 \text{ M}\Omega$ whichever is smaller. Note: ※LD Low distortion high value multilayer ceramic capacitor | | |
| Test Methods and Remarks | | Class 1 | | Class 2 | |
| | | Standard | High Frequency Type | All items | |
| | Preconditioning | None | | | Thermal treatment (at 150°C for 1 hr) Note 2 |
| | Temperature | $40 \pm 2^\circ\text{C}$ | $60 \pm 2^\circ\text{C}$ | $40 \pm 2^\circ\text{C}$ | |
| | Humidity | 90 to 95%RH | | 90 to 95%RH | |
| | Duration | $500 + 24 / - 0$ hrs | | $500 + 24 / - 0$ hrs | |
| | Recovery | 6 to 24 hrs (Standard condition) Note 5 | | 24 ± 2 hrs (Standard condition) Note 5 | |

| 16. Humidity Loading | | | | | |
|--------------------------|---|--------------------------|--|--------------------------|---|
| Specified Value | Temperature Compensating(Class1) | Standard | Appearance : No abnormality Capacitance change : Within $\pm 7.5\%$ or $\pm 0.75\text{pF}$, whichever is larger. Q : $C < 30\text{pF} : Q \geq 100 + 10C/3$ $C \geq 30\text{pF} : Q \geq 200 (C : \text{Nominal capacitance})$ Insulation resistance : $500 \text{ M}\Omega$ min. | | |
| | | High Frequency Type | Appearance : No abnormality Capacitance change : $C \leq 2\text{pF} : \text{Within } \pm 0.4 \text{ pF}$ $C > 2\text{pF} : \text{Within } \pm 0.75 \text{ pF}$ (C:Nominal capacitance) Insulation resistance : $500 \text{ M}\Omega$ min. | | |
| | High Permittivity (Class2) Note 1 | | Appearance : No abnormality Capacitance change : Within $\pm 12.5\%$ (BJ, B7, C6, C7, D7, LD(※)) Dissipation factor : 5.0% max. (BJ, B7, C6, C7, D7, LD(※)) Insulation resistance : $25 \text{ M}\Omega \mu\text{F}$ or $500 \text{ M}\Omega$, whichever is smaller. Note: ※LD Low distortion high value multilayer ceramic capacitor | | |
| Test Methods and Remarks | | Class 1 | | Class 2 | |
| | | Standard | High Frequency Type | All items | |
| | Preconditioning | None | | | Voltage treatment (Rated voltage are applied for 1 hour at 40°C) Note 3 |
| | Temperature | $40 \pm 2^\circ\text{C}$ | $60 \pm 2^\circ\text{C}$ | $40 \pm 2^\circ\text{C}$ | |
| | Humidity | 90 to 95%RH | | 90 to 95%RH | |
| | Duration | $500 + 24 / - 0$ hrs | | $500 + 24 / - 0$ hrs | |
| | Applied voltage | Rated voltage | | Rated voltage | |
| | Charge/discharge current | 50mA max. | | 50mA max. | |
| Recovery | 6 to 24 hrs (Standard condition) Note 5 | | 24 ± 2 hrs (Standard condition) Note 5 | | |

17. High Temperature Loading

| | | | |
|-----------------|-----------------------------------|---|--|
| Specified Value | Temperature Compensating (Class1) | Standard | Appearance : No abnormality Capacitance change : Within $\pm 3\%$ or $\pm 0.3\text{pF}$, whichever is larger. Q : $C < 10\text{pF}$: $Q \geq 200 + 10C$ $10 \leq C < 30\text{pF}$: $Q \geq 275 + 2.5C$ $C \geq 30\text{pF}$: $Q \geq 350$ (C: Nominal capacitance) Insulation resistance : 1000 M Ω min. |
| | | High Frequency Type | Appearance : No abnormality Capacitance change : Within $\pm 3\%$ or $\pm 0.3\text{pF}$, whichever is larger. Insulation resistance : 1000 M Ω min. |
| | High Permittivity (Class2) Note 1 | Appearance : No abnormality Capacitance change : Within $\pm 12.5\%$ (BJ, B7, C6, C7, D7, LD(※)) Dissipation factor : 5.0% max. (BJ, B7, C6, C7, D7, LD(※)) Insulation resistance : 50 M Ω μF or 1000 M Ω , whichever is smaller. Note: ※LD Low distortion high value multilayer ceramic capacitor | |

| | | | | | | |
|--------------------------|--------------------------|---------------------------------------|---------------------|---|----|------------|
| Test Methods and Remarks | | Class 1 | | Class 2 | | |
| | | Standard | High Frequency Type | BJ, LD(※) | C6 | B7, C7, D7 |
| | Preconditioning | None | | Voltage treatment (Twice the rated voltage shall be applied for 1 hour at 85°C, 105°C or 125°C) Note 3, 4 | | |
| | Temperature | Maximum operating temperature | | Maximum operating temperature | | |
| | Duration | 1000 + 48 / - 0 hrs | | 1000 + 48 / - 0 hrs | | |
| | Applied voltage | Rated voltage $\times 2$ | | Rated voltage $\times 2$ Note 4 | | |
| | Charge/discharge current | 50mA max. | | 50mA max. | | |
| | Recovery | 6 to 24hr (Standard condition) Note 5 | | 24 \pm 2 hrs (Standard condition) Note 5 | | |

Note: ※LD Low distortion high value multilayer ceramic capacitor

Note 1 The figures indicate typical specifications. Please refer to individual specifications in detail.

Note 2 Thermal treatment : Initial value shall be measured after test sample is heat-treated at 150 \pm 0 / - 10°C for an hour and kept at room temperature for 24 \pm 2 hours.

Note 3 Voltage treatment : Initial value shall be measured after test sample is voltage-treated for an hour at both the temperature and voltage specified in the test conditions, and kept at room temperature for 24 \pm 2 hours.

Note 4 150% of rated voltage is applicable to some items. Please refer to their specifications for further information.

Note 5 Standard condition: Temperature: 5 to 35°C, Relative humidity: 45 to 85 % RH, Air pressure: 86 to 106kPa When there are questions concerning measurement results, in order to provide correlation data, the test shall be conducted under the following condition.
Temperature: 20 \pm 2°C, Relative humidity: 60 to 70 % RH, Air pressure: 86 to 106kPa Unless otherwise specified, all the tests are conducted under the "standard condition".

Medium-High Voltage Multilayer Ceramic Capacitor

RELIABILITY DATA

| 1. Operating Temperature Range | |
|---|--|
| Specified Value | Temperature Compensating(High Frequency type) CG(C0G) : -55 to +125°C |
| | High permittivity X7R, X7S : -55 to +125°C X5 : -55 to +85°C B : -25 to +85°C |
| 2. Storage Temperature Range | |
| Specified Value | Temperature Compensating(High Frequency type) CG(C0G) : -55 to +125°C |
| | High permittivity X7R, X7S : -55 to +125°C X5R : -55 to +85°C B : -25 to +85°C |
| 3. Rated Voltage | |
| Specified Value | 100VDC(HMK,HMJ), 250VDC(QMK,QMJ,QVS), 630VDC(SMK,SMJ) |
| 4. Withstanding Voltage (Between terminals) | |
| Specified Value | No breakdown or damage |
| Test Methods and Remarks | Applied voltage : Rated voltage × 2.5 (HMK,HMJ), Rated voltage × 2 (QMK,QMJ,QVS), Rated voltage × 1.2 (SMK,SMJ) Duration : 1 to 5sec. Charge/discharge current : 50mA max. |
| 5. Insulation Resistance | |
| Specified Value | Temperature Compensating(High Frequency type) 10000MΩ min |
| | High permittivity 100MΩ μF or 10GΩ, whichever is smaller. |
| Test Methods and Remarks | Applied voltage : Rated voltage (HMK,HMJ, QMK,QMJ,QVS), 500V (SMK,SMJ) Duration : 60±5sec. Charge/discharge current : 50mA max. |
| 6. Capacitance (Tolerance) | |
| Specified Value | Temperature Compensating(High Frequency type) ±0.1pF (C<5pF) ±0.25pF (C<10pF) ±0.5pF (5pF≤C<10pF) ±2%(C=10pF) ±5%(C≥10pF) |
| | High permittivity ±10%, ±20% |
| Test Methods and Remarks | Temperature Compensating(High Frequency type) Measuring frequency : 1MHz±10% Measuring voltage : 0.5 to 5Vrms Bias application : None |
| | High permittivity Measuring frequency : 1kHz±10% Measuring voltage : 1±0.2Vrms Bias application : None |

| 7. Q or Dissipation Factor | |
|----------------------------|---|
| Specified Value | Temperature Compensating(High Frequency type) $C < 30\text{pF} : Q \geq 800 + 20C$ $C \geq 30\text{pF} : Q \geq 1400$ C:Normal Capacitance(/pF) High permittivity 3.5%max (HMK,HMJ) 2.5%max (QMK,QMJ, SMK,SMJ) |
| Test Methods and Remarks | Temperature Compensating(High Frequency type) Measuring frequency : 1MHz±10% Measuring voltage : 0.5 to 5Vrms Bas application : None High permittivity Measuring frequency : 1kHz±10% Measuring voltage : 1±0.2Vrms Bas application : None |

8. Temperature Characteristic of Capacitance

| Specified Value | Temperature Compensating(High Frequency type) C0G : ±30ppm(25 to +125°C) High permittivity B : ±10% (-25 to +85°C) X5R : ±15% (-55 to +85°C) X7R : ±15% (-55 to +125°C) X7S : ±22% (-55 to +125°C) | | | | | | | | | | | | |
|--------------------------|--|---------------|---|---------------|---|------------------------------|--|---|------|------|---|-------------------------------|--|
| Test Methods and Remarks | Temperature Compensating(High Frequency type) Capacitance at 25°C and 85°C shall be measured in thermal equilibrium, and the temperature characteristic shall be calculated from the following equation. $\frac{(C_{85} - C_{25})}{C_{25} \times \Delta T} \times 10^6 \times [\text{ppm}/^\circ\text{C}]$ High permittivity Capacitance value at each step shall be measured in thermal equilibrium, and the temperature characteristic shall be calculated from the following equation. <table border="1" style="margin-left: 20px;"> <thead> <tr> <th>Step</th> <th>B</th> <th>X5R, X7R, X7S</th> </tr> </thead> <tbody> <tr> <td>1</td> <td colspan="2">Minimum operating teperature</td> </tr> <tr> <td>2</td> <td>20°C</td> <td>25°C</td> </tr> <tr> <td>3</td> <td colspan="2">Maximum operating temperature</td> </tr> </tbody> </table> $\frac{(C - C_2)}{C_2} \times 100(\%)$ C : Capacitance value in Step 1 or Step 3 C2 : Capacitance value in Step 2 | Step | B | X5R, X7R, X7S | 1 | Minimum operating teperature | | 2 | 20°C | 25°C | 3 | Maximum operating temperature | |
| Step | B | X5R, X7R, X7S | | | | | | | | | | | |
| 1 | Minimum operating teperature | | | | | | | | | | | | |
| 2 | 20°C | 25°C | | | | | | | | | | | |
| 3 | Maximum operating temperature | | | | | | | | | | | | |

9. Deflection

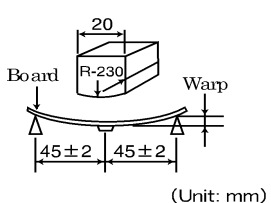
| | |
|--------------------------|---|
| Specified Value | Temperature Compensating(High Frequency type) Appearance : No abnormality Capacitance change : ±5% or ±0.5pF, whichever is larger. High permittivity Appearance : No abnormality Capacitance change : Within ±10% |
| Test Methods and Remarks | Warp : 1mm (Soft Termination type:3mm) Duration : 10sec. Test board : Glass epoxy-resin substrate Thicknss : 1.6mm <div style="text-align: center;">  <p>(Unit: mm)</p> </div> Capacitance measurement shall be conducted with the board bent. |

▶ This catalog contains the typical specification only due to the limitation of space. When you consider the purchase of our products, please check our specification. For details of each product (characteristics graph, reliability information, precautions for use, and so on), see our Web site (<http://www.ty-top.com/>).

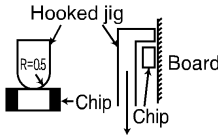
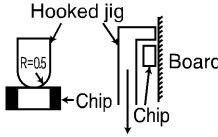
| 10. Adhesive Strength of Terminal Electrodes | |
|--|--|
| Specified Value | No terminal separation or its indication. |
| Test Methods and Remarks | Temperature Compensating(High Frequency type) Applied force : 2N Duration : 10±5sec.  |
| | High permittivity Applied force : 5N Duration : 30±5sec.  |

| 11. Solderability | | | |
|--------------------------|---|-----------------|------------------|
| Specified Value | At least 95% of terminal electrode is covered by new solder | | |
| Test Methods and Remarks | | Eutectic solder | Lead-free solder |
| | Solder type | H60A or H63A | Sn-3.0Ag-0.5Cu |
| | Solder temperature | 230±5°C | 245±3°C |
| | Duration | 4±1 sec. | |

| 12. Resistance to Soldering | |
|-----------------------------|--|
| Specified Value | Temperature Compensating(High Frequency type) Appearance : No abnormality Capacitance change : C※ ≤ 10pF : ±0.25pF C※ > 10pF : ±2.5% ※Normal capacitance Insulation resistance : Initial value Withstanding voltage (between terminals) : No abnormality |
| | High permittivity Appearance : No abnormality Capacitance change : Within ±15% (HMK, HMJ), ±10% (QMK, QMJ, SMK, SMJ) Dissipation factor : Initial value Insulation resistance : Initial value Withstanding voltage (between terminals) : No abnormality |
| Test Methods and Remarks | Preconditioning : Thermal treatment (at 150°C for 1hr) Note1 (Only High permittivity) Solder temperature : 270±5°C Duration : 3±0.5sec. Preheating conditions : 80 to 100°C, 2 to 5 min. 150 to 200°C, 2 to 5min. Recovery : 24±2hrs under the standard condition Note3 |

| 13. Temperature Cycle (Thermal Shock) | | | | | | | | | | | | | | | | |
|---------------------------------------|---|------------------|------------------|-------------|---|-------------------------------|----------|---|--------------------|------------|---|-------------------------------|----------|---|--------------------|------------|
| Specified Value | Temperature Compensating(High Frequency type) Appearance : No abnormality Capacitance change : C※ ≤ 10pF : ±0.25% C※ > 10pF : ±2.5% Insulation resistance : Initial value Withstanding voltage (between terminals) : No abnormality | | | | | | | | | | | | | | | |
| | High permittivity Appearance : No abnormality Capacitance change : Within ±15% (HMK, HMJ), ±7.5% (QMK, QMJ, SMK, SMJ) Dissipation factor : Initial value Insulation resistance : Initial value Withstanding voltage (between terminals) : No abnormality | | | | | | | | | | | | | | | |
| Test Methods and Remarks | Preconditioning : Thermal treatment (at 150°C for 1hr) Note1 Conditions for 1 cycle <table border="1" data-bbox="287 1780 1125 1921"> <thead> <tr> <th>Step</th> <th>temperature (°C)</th> <th>Time (min.)</th> </tr> </thead> <tbody> <tr> <td>1</td> <td>Minimum operating temperature</td> <td>30±3min.</td> </tr> <tr> <td>2</td> <td>Normal temperature</td> <td>2 to 3min.</td> </tr> <tr> <td>3</td> <td>Maximum operating temperature</td> <td>30±3min.</td> </tr> <tr> <td>4</td> <td>Normal temperature</td> <td>2 to 3min.</td> </tr> </tbody> </table> | Step | temperature (°C) | Time (min.) | 1 | Minimum operating temperature | 30±3min. | 2 | Normal temperature | 2 to 3min. | 3 | Maximum operating temperature | 30±3min. | 4 | Normal temperature | 2 to 3min. |
| | Step | temperature (°C) | Time (min.) | | | | | | | | | | | | | |
| 1 | Minimum operating temperature | 30±3min. | | | | | | | | | | | | | | |
| 2 | Normal temperature | 2 to 3min. | | | | | | | | | | | | | | |
| 3 | Maximum operating temperature | 30±3min. | | | | | | | | | | | | | | |
| 4 | Normal temperature | 2 to 3min. | | | | | | | | | | | | | | |
| | Number of cycles : 5 times Recovery : 24±2hrs under the standard condition Note3 | | | | | | | | | | | | | | | |

▶ This catalog contains the typical specification only due to the limitation of space. When you consider the purchase of our products, please check our specification. For details of each product (characteristics graph, reliability information, precautions for use, and so on), see our Web site (<http://www.ty-top.com/>).

| 14. Humidity (Steady state) | |
|-----------------------------|--|
| Specified Value | Temperature Compensating(High Frequency type) Appearance : No abnormality Capacitance change : $C \times \leq 10\text{pF} : \pm 0.5\text{pF}$ $C \times > 10\text{pF} : \pm 5\%$ \times Normal capacitance Insulation resistance : $1000\text{M}\Omega$ min |
| | High permittivity Appearance : No abnormality Capacitance change : Within $\pm 15\%$ Dissipation factor : $7\%_{\text{max}}$ (HMK, HMJ), $5\%_{\text{max}}$ (QMK, QMJ, SMK, SMJ). Insulation resistance : $25\text{M}\Omega \mu\text{F}$ or $1000\text{M}\Omega$, whichever is smaller. |
| Test Methods and Remarks | Preconditioning : Thermal treatment (at 150°C for 1hr) Note1 (Only High permittivity) Temperature : $40 \pm 2^\circ\text{C}$ Humidity : 90 to 95%RH Duration : 500 +24/−0 hrs Recovery : 24 ± 2 hrs under the standard condition Note3 |

| 15. Humidity Loading | |
|--------------------------|---|
| Specified Value | Temperature Compensating(High Frequency type) Appearance : No abnormality Capacitance change : $C \times \leq 2.0\text{pF} : \pm 0.4\text{pF}$ $2.0\text{pF} < C \leq 10\text{pF} : \pm 0.75\text{pF}$ $C \times > 10\text{pF} : \pm 7.5\%$: \times Normal capacitance Insulation resistance : $500\text{M}\Omega$ min |
| | High permittivity Appearance : No abnormality Capacitance change : Within $\pm 15\%$ Dissipation factor : $7\%_{\text{max}}$ (HMK, HMJ), $5\%_{\text{max}}$ (QMK, QMJ, SMK, SMJ). Insulation resistance : $10\text{M}\Omega \mu\text{F}$ or $500\text{M}\Omega$, whichever is smaller. |
| Test Methods and Remarks | According to JIS 5102 clause 9.9. Preconditioning : Voltage treatment Note2 (Only High permittivity) Temperature : $40 \pm 2^\circ\text{C}$ Humidity : 90 to 95%RH Applied voltage : Rated voltage Charge/discharge current : 50mA max. Duration : 500 +24/−0 hrs Recovery : 24 ± 2 hrs under the standard condition Note3 |

| 16. High Temperature Loading | |
|------------------------------|---|
| Specified Value | Temperature Compensating(High Frequency type) Appearance : No abnormality Capacitance change : $C \times \leq 10\text{pF} : \pm 0.3\text{pF}$ $C \times > 10\text{pF} : \pm 3\%$ Insulation resistance : $1000\text{M}\Omega$ min |
| | High permittivity Appearance : No abnormality Capacitance change : Within $\pm 15\%$ Dissipation factor : $7\%_{\text{max}}$ (HMK, HMJ), $5\%_{\text{max}}$ (QMK, QMJ, SMK, SMJ). Insulation resistance : $50\text{M}\Omega \mu\text{F}$ or $1000\text{M}\Omega$, whichever is smaller. |
| Test Methods and Remarks | According to JIS 5102 clause 9.10. Preconditioning : Voltage treatment Note2 (Only High permittivity) Temperature : Maximum operating temperature Applied voltage : Rated voltage $\times 2$ (HMK, HMJ, QVS) Rated voltage $\times 1.5$ (QMK, QMJ) Rated voltage $\times 1.2$ (SMK, SMJ) Charge/discharge current : 50mA max. Duration : 1000 +24/−0 hrs Recovery : 24 ± 2 hrs under the standard condition Note3 |

Note1 Thermal treatment : Initial value shall be measured after test sample is heat-treated at $150 \pm 0/ - 10^\circ\text{C}$ for an hour and kept at room temperature for 24 ± 2 hours.

Note2 Voltage treatment : Initial value shall be measured after test sample is voltage-treated for an hour at both the temperature and voltage specified in the test conditions, and kept at room temperature for 24 ± 2 hours.

Note3 Standard condition : Temperature: 5 to 35°C , Relative humidity: 45 to 85 % RH, Air pressure: 86 to 106kPa
When there are questions concerning measurement results, in order to provide correlation data, the test shall be conducted under the following condition.
Temperature: $20 \pm 2^\circ\text{C}$, Relative humidity: 60 to 70 % RH, Air pressure: 86 to 106kPa
Unless otherwise specified, all the tests are conducted under the "standard condition".

Precautions on the use of Multilayer Ceramic Capacitors

PRECAUTIONS

1. Circuit Design

Precautions

- ◆ Verification of operating environment, electrical rating and performance
 1. A malfunction of equipment in fields such as medical, aerospace, nuclear control, etc. may cause serious harm to human life or have severe social ramifications. Therefore, any capacitors to be used in such equipment may require higher safety and reliability, and shall be clearly differentiated from them used in general purpose applications.
- ◆ Operating Voltage (Verification of Rated voltage)
 1. The operating voltage for capacitors must always be their rated voltage or less. If an AC voltage is loaded on a DC voltage, the sum of the two peak voltages shall be the rated voltage or less. For a circuit where an AC or a pulse voltage may be used, the sum of their peak voltages shall also be the rated voltage or less.
 2. Even if an applied voltage is the rated voltage or less reliability of capacitors may be deteriorated in case that either a high frequency AC voltage or a pulse voltage having rapid rise time is used in a circuit.

2. PCB Design

Precautions

- ◆ Pattern configurations (Design of Land-patterns)
 1. When capacitors are mounted on PCBs, the amount of solder used (size of fillet) can directly affect the capacitor performance. Therefore, the following items must be carefully considered in the design of land patterns:
 - (1) Excessive solder applied can cause mechanical stresses which lead to chip breaking or cracking. Therefore, please consider appropriate land-patterns for proper amount of solder.
 - (2) When more than one component are jointly soldered onto the same land, each component's soldering point shall be separated by solder-resist.
- ◆ Pattern configurations (Capacitor layout on PCBs)
 After capacitors are mounted on boards, they can be subjected to mechanical stresses in subsequent manufacturing processes (PCB cutting, board inspection, mounting of additional parts, assembly into the chassis, wave soldering of the boards, etc.). For this reason, land pattern configurations and positions of capacitors shall be carefully considered to minimize stresses.

Technical considerations

- ◆ Pattern configurations (Design of Land-patterns)
 The following diagrams and tables show some examples of recommended land patterns to prevent excessive solder amounts.

(1) Recommended land dimensions for typical chip capacitors

● Multilayer Ceramic Capacitors : Recommended land dimensions (unit: mm)

| | | Wave-soldering | | | |
|------|---|----------------|------------|------------|------------|
| Type | | 107 | 212 | 316 | 325 |
| Size | L | 1.6 | 2.0 | 3.2 | 3.2 |
| | W | 0.8 | 1.25 | 1.6 | 2.5 |
| A | | 0.8 to 1.0 | 1.0 to 1.4 | 1.8 to 2.5 | 1.8 to 2.5 |
| B | | 0.5 to 0.8 | 0.8 to 1.5 | 0.8 to 1.7 | 0.8 to 1.7 |
| C | | 0.6 to 0.8 | 0.9 to 1.2 | 1.2 to 1.6 | 1.8 to 2.5 |

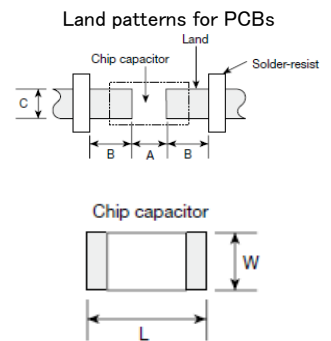

Reflow-soldering

| Type | | 042 | 063 | 105 | 107 | 212 | 316 | 325 | 432 |
|------|---|--------------|--------------|--------------|------------|------------|------------|------------|------------|
| Size | L | 0.4 | 0.6 | 1.0 | 1.6 | 2.0 | 3.2 | 3.2 | 4.5 |
| | W | 0.2 | 0.3 | 0.5 | 0.8 | 1.25 | 1.6 | 2.5 | 3.2 |
| A | | 0.15 to 0.25 | 0.20 to 0.30 | 0.45 to 0.55 | 0.8 to 1.0 | 0.8 to 1.2 | 1.8 to 2.5 | 1.8 to 2.5 | 2.5 to 3.5 |
| B | | 0.15 to 0.20 | 0.20 to 0.30 | 0.40 to 0.50 | 0.6 to 0.8 | 0.8 to 1.2 | 1.0 to 1.5 | 1.0 to 1.5 | 1.5 to 1.8 |
| C | | 0.15 to 0.30 | 0.25 to 0.40 | 0.45 to 0.55 | 0.6 to 0.8 | 0.9 to 1.6 | 1.2 to 2.0 | 1.8 to 3.2 | 2.3 to 3.5 |

Note: Recommended land size might be different according to the allowance of the size of the product.



● LWDC: Recommended land dimensions for reflow-soldering (unit: mm)

| Type | | 105 | 107 | 212 |
|------|---|--------------|-------------|------------|
| Size | L | 0.52 | 0.8 | 1.25 |
| | W | 1.0 | 1.6 | 2.0 |
| A | | 0.18 to 0.22 | 0.25 to 0.3 | 0.5 to 0.7 |
| B | | 0.2 to 0.25 | 0.3 to 0.4 | 0.4 to 0.5 |
| C | | 0.9 to 1.1 | 1.5 to 1.7 | 1.9 to 2.1 |



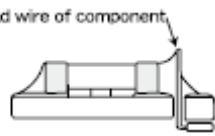
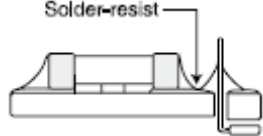

▶ This catalog contains the typical specification only due to the limitation of space. When you consider the purchase of our products, please check our specification. For details of each product (characteristics graph, reliability information, precautions for use, and so on), see our Web site (<http://www.ty-top.com/>).

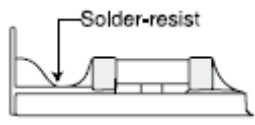
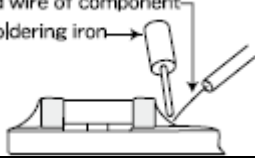
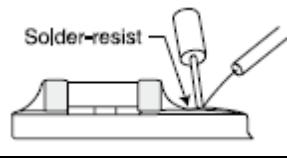
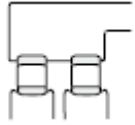
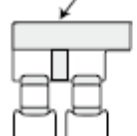
(2) Examples of good and bad solder application

| Items | Not eommended | Recommended |
|---|---|---|
| Mixed mounting of SMD and leaded components |  |  |
| Component placement close to the chassis |  |  |
| Hand-soldering of leaded Components near mounted components |  |  |
| Horizontal component placement |  |  |

◆Pattern configurations (Capacitor layout on PCBs)

1-1. The following is examples of good and bad capacitor layouts ; capacitors shall be located to minimize any possible mechanical stresses from board warp or deflection.

| Items | Not recommended | Recommended |
|---------------------|--|--|
| Deflection of board |  |  Place the product at a right angle to the direction of the anticipated mechanical stress. |

1-2. The amount of mechanical stresses given will vary depending on capacitor layout. Please refer to diagram below.

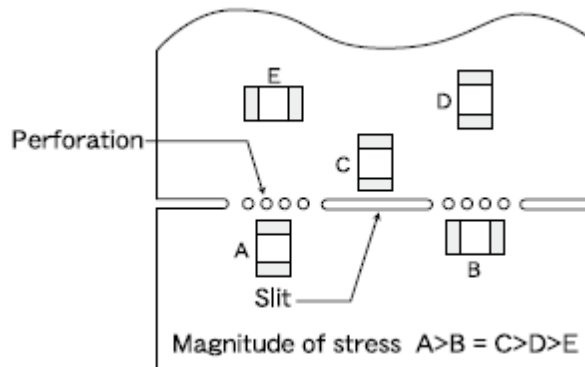

1-3. When PCB is split, the amount of mechanical stress on the capacitors can vary according to the method used. The following methods are listed in order from least stressful to most stressful: push-back, slit, V-grooving, and perforation. Thus, please consider the PCB, split methods as well as chip location.

3. Mounting

| | |
|--------------------------|---|
| Precautions | <p>◆Adjustment of mounting machine</p> <ol style="list-style-type: none"> When capacitors are mounted on PCB, excessive impact load shall not be imposed on them. Maintenance and inspection of mounting machines shall be conducted periodically. <p>◆Selection of Adhesives</p> <ol style="list-style-type: none"> When chips are attached on PCBs with adhesives prior to soldering, it may cause capacitor characteristics degradation unless the following factors are appropriately checked : size of land patterns, type of adhesive, amount applied, hardening temperature and hardening period. Therefore, please contact us for further information. |
| Technical considerations | <p>◆Adjustment of mounting machine</p> <ol style="list-style-type: none"> When the bottom dead center of a pick-up nozzle is too low, excessive force is imposed on capacitors and causes damages. To avoid this, the following points shall be considerable. <ol style="list-style-type: none"> The bottom dead center of the pick-up nozzle shall be adjusted to the surface level of PCB without the board deflection. The pressure of nozzle shall be adjusted between 1 and 3 N static loads. To reduce the amount of deflection of the board caused by impact of the pick-up nozzle, supporting pins or back-up pins shall be used on the other side of the PCB. The following diagrams show some typical examples of good and bad pick-up nozzle placement: |

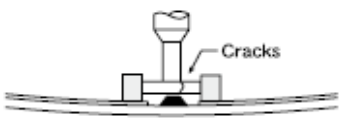
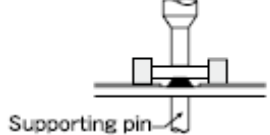
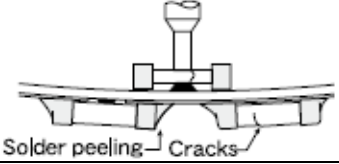
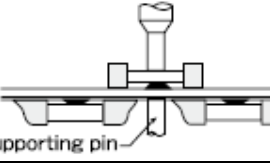
| Items | Not recommended | Recommended |
|-----------------------|---|---|
| Single-sided mounting |  |  |
| Double-sided mounting |  |  |

2. As the alignment pin is worn out, adjustment of the nozzle height can cause chipping or cracking of capacitors because of mechanical impact on the capacitors.
To avoid this, the monitoring of the width between the alignment pins in the stopped position, maintenance, check and replacement of the pin shall be conducted periodically.

◆ Selection of Adhesives

Some adhesives may cause IR deterioration. The different shrinkage percentage of between the adhesive and the capacitors may result in stresses on the capacitors and lead to cracking. Moreover, too little or too much adhesive applied to the board may adversely affect components. Therefore, the following precautions shall be noted in the application of adhesives.

(1) Required adhesive characteristics

- The adhesive shall be strong enough to hold parts on the board during the mounting & solder process.
- The adhesive shall have sufficient strength at high temperatures.
- The adhesive shall have good coating and thickness consistency.
- The adhesive shall be used during its prescribed shelf life.
- The adhesive shall harden rapidly.
- The adhesive shall have corrosion resistance.
- The adhesive shall have excellent insulation characteristics.
- The adhesive shall have no emission of toxic gasses and no effect on the human body.

(2) The recommended amount of adhesives is as follows;

[Recommended condition]

| Figure | 212/316 case sizes as examples |
|--------|----------------------------------|
| a | 0.3mm min |
| b | 100 to 120 μ m |
| c | Adhesives shall not contact land |

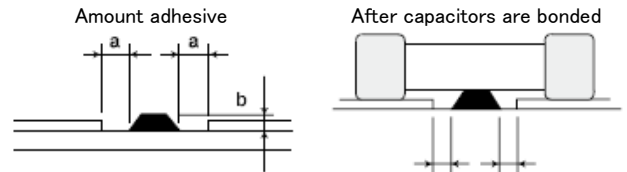

4. Soldering

◆ Selection of Flux

Since flux may have a significant effect on the performance of capacitors, it is necessary to verify the following conditions prior to use;

- Flux used shall be less than or equal to 0.1 wt% (in Cl equivalent) of halogenated content. Flux having a strong acidity content shall not be applied.
- When shall capacitors are soldered on boards, the amount of flux applied shall be controlled at the optimum level.
- When water-soluble flux is used, special care shall be taken to properly clean the boards.

Precautions

◆ Soldering

Temperature, time, amount of solder, etc. shall be set in accordance with their recommended conditions.
Sn-Zn solder paste can adversely affect MLCC reliability.
Please contact us prior to usage of Sn-Zn solder.

◆ Selection of Flux

- When too much halogenated substance (Chlorine, etc.) content is used to activate flux, or highly acidic flux is used, it may lead to corrosion of terminal electrodes or degradation of insulation resistance on the surfaces of the capacitors.
- Flux is used to increase solderability in wave soldering. However if too much flux is applied, a large amount of flux gas may be emitted and may adversely affect the solderability. To minimize the amount of flux applied, it is recommended to use a flux-bubbling system.
- Since the residue of water-soluble flux is easily dissolved in moisture in the air, the residues on the surfaces of capacitors in high humidity conditions may cause a degradation of insulation resistance and reliability of the capacitors. Therefore, the cleaning methods and the capability of the machines used shall also be considered carefully when water-soluble flux is used.

Technical considerations

◆ Soldering

- Ceramic chip capacitors are susceptible to thermal shock when exposed to rapid or concentrated heating or rapid cooling.
- Therefore, the soldering must be conducted with great care so as to prevent malfunction of the components due to excessive thermal shock.
- Preheating : Capacitors shall be preheated sufficiently, and the temperature difference between the capacitors and solder shall be within 100 to 130°C.
- Cooling : The temperature difference between the capacitors and cleaning process shall not be greater than 100°C.

* This catalog contains the typical specification only due to the limitation of space. When you consider the purchase of our products, please check our specification.
For details of each product (characteristics graph, reliability information, precautions for use, and so on), see our Web site (<http://www.ty-top.com/>).

[Reflow soldering]

【Recommended conditions for eutectic soldering】

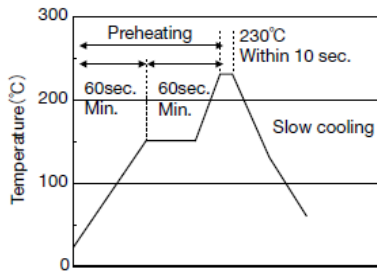

【Recommended condition for Pb-free soldering】

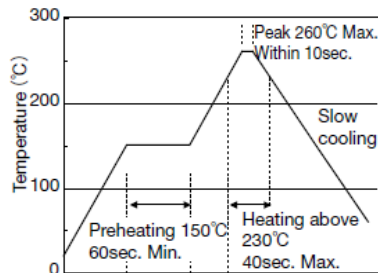

Caution

- ① The ideal condition is to have solder mass(fillet) controlled to 1/2 to 1/3 of the thickness of a capacitor.
- ② Because excessive dwell times can adversely affect solderability, soldering duration shall be kept as close to recommended times as possible.
- ③ Allowable number of reflow soldering : 2 times max.

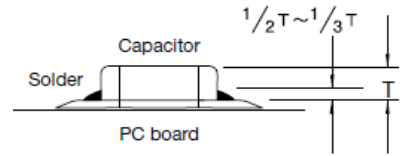

[Wave soldering]

【Recommended conditions for eutectic soldering】

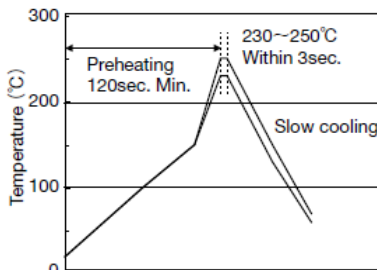

【Recommended condition for Pb-free soldering】

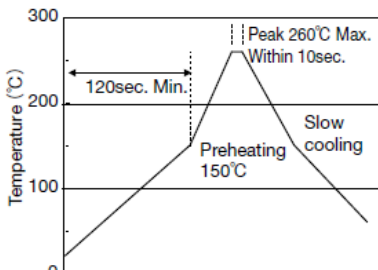

Caution

- ① Wave soldering must not be applied to capacitors designated as for reflow soldering only.
- ② Allowable number of wave soldering : 1 times max.

[Hand soldering]

【Recommended conditions for eutectic soldering】

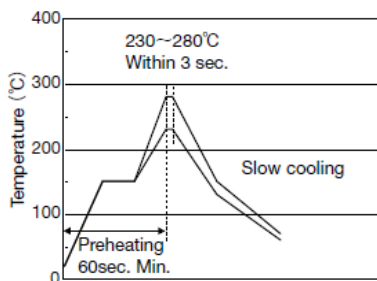

【Recommended condition for Pb-free soldering】

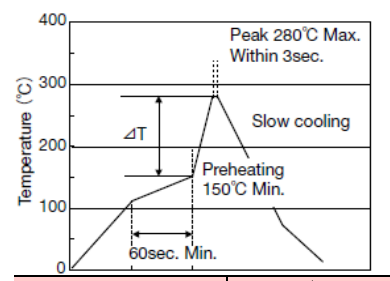
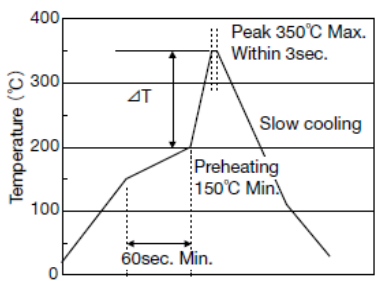

| | |
|-----------------|------------|
| | ΔT |
| 316type or less | ΔT ≤ 150°C |

| | |
|-----------------|------------|
| | ΔT |
| 325type or more | ΔT ≤ 130°C |

Caution

- ① Use a 50W soldering iron with a maximum tip diameter of 1.0 mm.
- ② The soldering iron shall not directly touch capacitors.
- ③ Allowable number of hand soldering : 1 times max.

5. Cleaning

| | |
|--------------------------|---|
| Precautions | ◆Cleaning conditions |
| | <ol style="list-style-type: none"> 1. When PCBs are cleaned after capacitors mounting, please select the appropriate cleaning solution in accordance with the intended use of the cleaning. (e.g. to remove soldering flux or other materials from the production process.) 2. Cleaning condition shall be determined after it is verified by using actual cleaning machine that the cleaning process does not affect capacitor's characteristics. |
| Technical considerations | <ol style="list-style-type: none"> 1. The use of inappropriate cleaning solutions can cause foreign substances such as flux residue to adhere to capacitors or deteriorate their outer coating, resulting in a degradation of the capacitor's electrical properties (especially insulation resistance). 2. Inappropriate cleaning conditions(insufficient or excessive cleaning) may adversely affect the performance of the capacitors. In the case of ultrasonic cleaning, too much power output can cause excessive vibration of PCBs which may lead to the cracking of capacitors or the soldered portion, or decrease the terminal electrodes' strength. Therefore, the following conditions shall be carefully checked; Ultrasonic output : 20 W/l or less Ultrasonic frequency : 40 kHz or less |

▶ This catalog contains the typical specification only due to the limitation of space. When you consider the purchase of our products, please check our specification. For details of each product (characteristics graph, reliability information, precautions for use, and so on), see our Web site (<http://www.ty-top.com/>).

| | |
|--|--|
| | Ultrasonic washing period : 5 min. or less |
| 6. Resin coating and mold | |
| Precautions | <p>1. With some type of resins, decomposition gas or chemical reaction vapor may remain inside the resin during the hardening period or while left under normal storage conditions resulting in the deterioration of the capacitor's performance.</p> <p>2. When a resin's hardening temperature is higher than capacitor's operating temperature, the stresses generated by the excessive heat may lead to damage or destruction of capacitors. The use of such resins, molding materials etc. is not recommended.</p> |
| 7. Handling | |
| Precautions | <p>◆Splitting of PCB</p> <p>1. When PCBs are split after components mounting, care shall be taken so as not to give any stresses of deflection or twisting to the board.</p> <p>2. Board separation shall not be done manually, but by using the appropriate devices.</p> <p>◆Mechanical considerations</p> <p>Be careful not to subject capacitors to excessive mechanical shocks.</p> <p>(1) If ceramic capacitors are dropped onto a floor or a hard surface, they shall not be used.</p> <p>(2) Please be careful that the mounted components do not come in contact with or bump against other boards or components.</p> |
| 8. Storage conditions | |
| Precautions | <p>◆Storage</p> <p>1. To maintain the solderability of terminal electrodes and to keep packaging materials in good condition, care must be taken to control temperature and humidity in the storage area. Humidity should especially be kept as low as possible.</p> <p>•Recommended conditions</p> <p style="padding-left: 20px;">Ambient temperature : Below 30°C</p> <p style="padding-left: 20px;">Humidity : Below 70% RH</p> <p>The ambient temperature must be kept below 40°C. Even under ideal storage conditions, solderability of capacitor is deteriorated as time passes, so capacitors shall be used within 6 months from the time of delivery.</p> <p>•Ceramic chip capacitors shall be kept where no chlorine or sulfur exists in the air.</p> <p>2. The capacitance values of high dielectric constant capacitors will gradually decrease with the passage of time, so care shall be taken to design circuits. Even if capacitance value decreases as time passes, it will get back to the initial value by a heat treatment at 150°C for 1 hour.</p> |
| Technical considerations | If capacitors are stored in a high temperature and humidity environment, it might rapidly cause poor solderability due to terminal oxidation and quality loss of taping/packaging materials. For this reason, capacitors shall be used within 6 months from the time of delivery. If exceeding the above period, please check solderability before using the capacitors. |
| <p>※RCR-2335B (Safety Application Guide for fixed ceramic capacitors for use in electronic equipment) is published by JEITA.</p> <p>Please check the guide regarding precautions for deflection test, soldering by spot heat, and so on.</p> | |

Mouser Electronics

Authorized Distributor

Click to View Pricing, Inventory, Delivery & Lifecycle Information:

Taiyo Yuden:

[TMK316ABJ106KD-T](#) [TMK107ABJ225KA-T](#) [TMK212AB7475KG-T](#) [TMK212AB7475MG-T](#) [TMK212BBJ106KG-T](#)
[TMK212BBJ475KD-T](#) [TMK316AB7475KL-T](#) [UMK212ABJ105KD-T](#) [UMK316AB7475KL-T](#) [UMK316ABJ475KD-T](#)
[UMK325AB7106KM-T](#) [EMK107ABJ475KA-T](#) [EMK212ABJ106KD-T](#) [EMK212ABJ225KD-T](#) [EMK325ABJ107MM-T](#)
[GMK325AB7106MM-T](#) [JMK105BBJ475MV-F](#) [JMK212AB7106KG-T](#) [UMK325AB7106MM-T](#) [UMK107ABJ474KA-T](#)
[UMK212BB7225KG-T](#) [AMK105CBJ106MV-F](#) [EMK107BBJ106MA-T](#) [EMK212BBJ226MG-T](#) [TMK316BBJ226ML-T](#)
[UMK107AB7105KA-T](#) [UMK316BBJ106ML-T](#) [EMK316ABJ226ML-T](#) [JMK212BBJ476MG-T](#) [AMK107ABJ106MAHT](#)
[AMK107BBJ226MAHT](#) [AMK212ABJ226MGHT](#) [AMK212AC6226MG-T](#) [AMK212BBJ476MGHT](#) [AMK212BC6476MG-T](#)
[AMK316AB7226MLHT](#) [AMK316ABJ107MLHT](#) [AMK325ABJ107MMHT](#) [AMK325ABJ227MM-T](#) [EMK105ABJ225MV-F](#)
[EMK105ABJ474KV-F](#) [EMK107ABJ225KAHT](#) [EMK107B7105KAHT](#) [EMK107B7473KAHT](#) [EMK107B7474KAHT](#)
[EMK107BJ104KAHT](#) [EMK107BJ105KAHT](#) [EMK107BJ224KAHT](#) [EMK107BJ474KAHT](#) [EMK212AB7475KGHT](#)
[EMK212ABJ225KDHT](#) [EMK212ABJ475KGHT](#) [EMK212B7105KGHT](#) [EMK212B7224KGHT](#) [EMK212B7225KGHT](#)
[EMK212B7474KGHT](#) [EMK212BB7106MG-T](#) [EMK212BBJ106KGHT](#) [EMK212BJ105KDHT](#) [EMK212BJ105KGHT](#)
[EMK212BJ225KGHT](#) [EMK212BJ475KDHT](#) [EMK316AB7106KLHT](#) [EMK316AB7106KL-T](#) [EMK316AB7475KLHT](#)
[EMK316B7225KLHT](#) [EMK316BBJ226MLHT](#) [EMK316BJ106KLHT](#) [EMK316BJ225KLHT](#) [EMK316BJ475KLHT](#)
[EMK325B7106KNHT](#) [EMK325B7226KMHT](#) [EMK325B7226MMHT](#) [EMK325BJ106MNHT](#) [EMK325BJ226MMHT](#)
[EMK325BJ475MNHT](#) [GMK107AB7105KAHT](#) [GMK107ABJ474KAHT](#) [GMK107B7104KAHT](#) [GMK107B7224KAHT](#)
[GMK107B7474KAHT](#) [GMK107BJ104KAHT](#) [GMK107BJ105KAHT](#) [GMK107BJ223KAHT](#) [GMK107BJ224KAHT](#)
[GMK107BJ473KAHT](#) [GMK212B7105KGHT](#) [GMK212B7224KGHT](#) [GMK212BJ104KGHT](#) [GMK212BJ105KGHT](#)
[GMK212BJ224KGHT](#) [GMK212BJ474KGHT](#) [GMK316AB7475KLHT](#) [GMK316B7105KLHT](#) [GMK316B7225KLHT](#)
[GMK316BJ105KLHT](#) [GMK316BJ225KLHT](#) [GMK316BJ475KLHT](#) [GMK325B7225MNHT](#) [GMK325BJ106MMHT](#)