

SX1230-12SKA

User's Guide: Advanced Mode

Table of Contents

1	Introduction	4
2	Getting Started	5
2.1	<i>Kit Contents.....</i>	5
2.2	<i>Installation.....</i>	5
3	Hardware Description	6
3.1	<i>SX1230SKA Overview</i>	6
3.2	<i>SX1212SKA Overview</i>	7
4	Quick Start Guide: MCU Mode	8
4.1	<i>SX1212SKA Quick Start</i>	8
4.2	<i>SX1230SKA Quick Start</i>	10
4.3	<i>Link Test.....</i>	13
5	Quick Start Guide: Stand Alone Mode	14
5.1	<i>SX1212SKA Configuration.....</i>	14
5.2	<i>SX1230SKA Configuration.....</i>	14
5.3	<i>Link Test.....</i>	15
6	SX1230SKA Software Description.....	16
6.1	<i>Overview</i>	16
6.2	<i>File Menu.....</i>	16
6.3	<i>Shortcut Buttons.....</i>	17
6.4	<i>General Configuration Tabs</i>	18
6.4.1	<i>General [1].....</i>	18
6.4.2	<i>General [2].....</i>	21
6.5	<i>Register Hexadecimal Display</i>	21
6.6	<i>Overview Panel</i>	22
6.7	<i>E²PROM Mode Tab.....</i>	22
6.8	<i>MCU Mode Tab.....</i>	25
6.9	<i>The Mode Control Box</i>	26
6.10	<i>MCU / E²PROM Mode Selection.....</i>	26
7	SX1212SKA Software Description.....	27
7.1	<i>Overview</i>	27
7.2	<i>File Menu.....</i>	27
7.3	<i>Shortcut Buttons.....</i>	28
7.4	<i>McParam Tab.....</i>	29
7.5	<i>Overview Panel</i>	31
7.6	<i>Register Hexadecimal Display</i>	31
7.7	<i>The Mode Control Box</i>	32
7.8	<i>The IrqParam Tab</i>	32
7.9	<i>The RxParam Tab.....</i>	33
7.10	<i>The TxParam Tab</i>	34
7.11	<i>The OscParam Tab</i>	35
7.12	<i>The Packet Test Tab.....</i>	35
8	Schematics and 4-Layer PCB Layout: SX1230SKA.....	37
9	Schematics and 2-Layer PCB Layout: SX1211/12SKA.....	40
10	References	42

Table of Figures

Figure 1. SX1230 Stand Alone Operation with Companion E ² PROM	4
Figure 2. SX1230 Connections for Microcontroller Based Operation	4
Figure 3: SX1230-12SKA Contents (CR2032 Cell not Shown)	5
Figure 4: SX1230SKA, 868 and 915 MHz Band, Board Picture	6
Figure 5: SX1212SKA Board Picture	7
Figure 6. SX1212 User Interface, Default Settings	8
Figure 7. The New SX1212 Configuration: Ready to be Written	9
Figure 8. The SX1212SKA User Interface whilst in Packet Receiver Mode.....	10
Figure 9. SX1230 User Interface, Default Settings	11
Figure 10. The New SX1230 Configuration: Ready to be Written	12
Figure 11. SX1230 During MCU Mode Packet Transmission.....	13
Figure 12. Hardware for E ² PROM (Stand Alone) Operation.....	14
Figure 13: SX1230SKA GUI Overview and References to the User Guide Description of this Chapter.....	16
Figure 14. Example Text Editor Output of the SX1230 Configuration File	17
Figure 15. The General Configuration Tab Features the most Commonly Used Configuration Parameters	18
Figure 16. Second Page of the General Configuration Parameters	21
Figure 17. Register Hexadecimal Display.....	21
Figure 18. The Configuration Overview Display	22
Figure 19. E ² PROM Memory Mapping.....	22
Figure 20. The E ² PROM Mode Tab 'Normal View'	23
Figure 21. E ² PROM Raw View.....	24
Figure 22. E ² PROM Raw View Short-cut Buttons.....	24
Figure 23. MCU Mode Tab Display.....	25
Figure 24. The Control Box	26
Figure 25. SX1212SKA GUI Overview and References to the User Guide Description of this Chapter.....	27
Figure 26. Example Text Editor Output of the SX1212 Configuration File	28
Figure 27. SX1212 Local Oscillator Generation.....	30
Figure 28. The Overview Panel.....	31
Figure 29. The Hexadecimal Register Display Summary	31
Figure 30. The Mode Control Box also Incorporates RSSI.....	32
Figure 31. The Interrupt Mapping Display.....	32
Figure 32. SX1212 Receiver Block Diagram, the Colours Correspond to the Frequency of Operation.....	33
Figure 33. Receiver Parameter Display	33
Figure 34. SX1212 Simplified Transmitter Block Schematic Diagram.....	34
Figure 35. The Transmitter Parameter Tab Display.....	34
Figure 36. The Oscillator Parameter Display	35
Figure 37. The Packet Receiver / Transmitter Test Display	36

1 Introduction

The SX1230 is a single chip transmitter IC designed for operation in the licence free ISM bands between 290 and 1020 MHz. The SX1230 is capable of operation either with or without an external companion microcontroller and features four internally de-bounced digital input pins to enable direct connection to switchgear for wireless remote control applications. Examples of both types of applications are shown below:

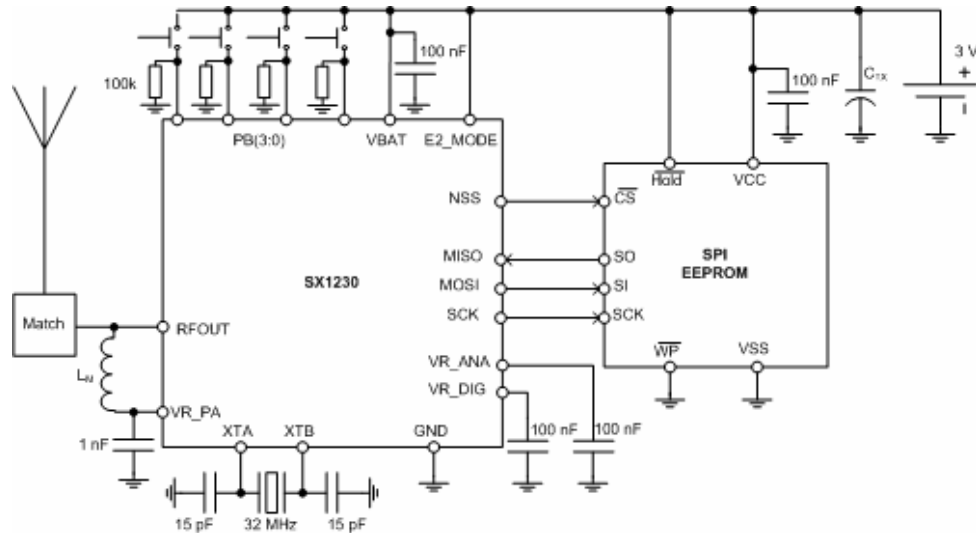

Figure 1. SX1230 Stand Alone Operation with Companion E²PROM

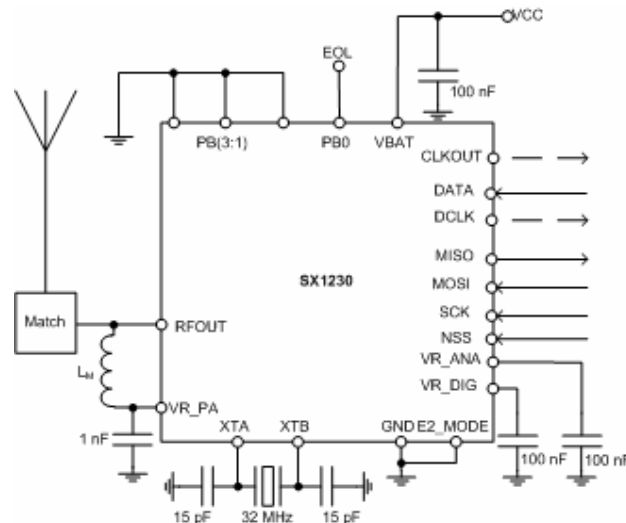

Figure 2. SX1230 Connections for Microcontroller Based Operation

The SX1230 main features include:

- +17 dBm to -18 dBm Programmable output power
- 1.8 to 3.7V Operating range with internal voltage regulation allowing constant RF performance
- Narrow and wide-band operation
- (G)FSK, (G)MSK and both filtered and unfiltered OOK operation.
- Support of bit rates from 1.2 to 600 kbps.
- Low battery detection
- Integrated RC timer for timer / wake-up applications
- Low phase noise -95 dBc/Hz at 50 kHz offset.
- -40°C to +85°C Temperature Range

2 Getting Started

2.1 Kit Contents

As illustrated in the figure below, the SX1230-12SKA Evaluation kit is composed of:

- SX1230SKA board
- SX1212SKA board
- SMA Connectorised Antenna for 434 MHz
- SX1230-12SKA CDROM including all necessary PC software and documentation
- A CR2032 Cell for operation of the SX1230SKA in stand alone mode, in conjunction with the companion E²PROM.



Figure 3: SX1230-12SKA Contents (CR2032 Cell not Shown)

2.2 Installation

The software for the SX1212SKA and SX1230SKA must each be installed individually. The installation process for each is identical.

SX1212SKA Advanced Mode Software Installation

- 1- Put the CDROM in your computer and browse the contents of the CD.
- 2- Open the "sx1212starterkitsetupweb.exe" manually. It can be found in the \Installers sub directory of the CD-ROM.
- 3- Follow installation guidelines until the process is completed. Please note that .NET Framework 2.0 and the FTDI USB driver will be automatically installed if not detected on your computer.
- 4- Connect the SX1212SKA board to the PC via the USB interface.
- 5- Launch "SX1212SKA" from the Start menu.
- 6- Click on "Connect" button in toolbar or in File menu.
- 7- SX1212SKA is now installed and ready to be used.

SX1230SKA Advanced Mode Software Installation

- 8- Put the CDROM in your computer and browse the contents of the CD.
- 9- Open the "sx1230starterkitsetupweb.exe" manually. It can be found in the \Installers sub directory of the CD-ROM.
- 10- Follow installation guidelines until the process is completed. Please note that .NET Framework 2.0 and the FTDI USB driver will be automatically installed if not detected on your computer.
- 11- Connect the SX1230SKA board to the PC via the USB interface.
- 12- Launch "SX1230SKA" from the Start menu.
- 13- Click on "Connect" button in toolbar or in File menu.
- 14- SX1230SKA is now installed and ready to be used.

3 Hardware Description

SX1230SKA and SX1212SKA boards are summarised in this chapter. Please refer to the schematics and layout provided in the document for further information about each hardware implementation.

3.1 SX1230SKA Overview

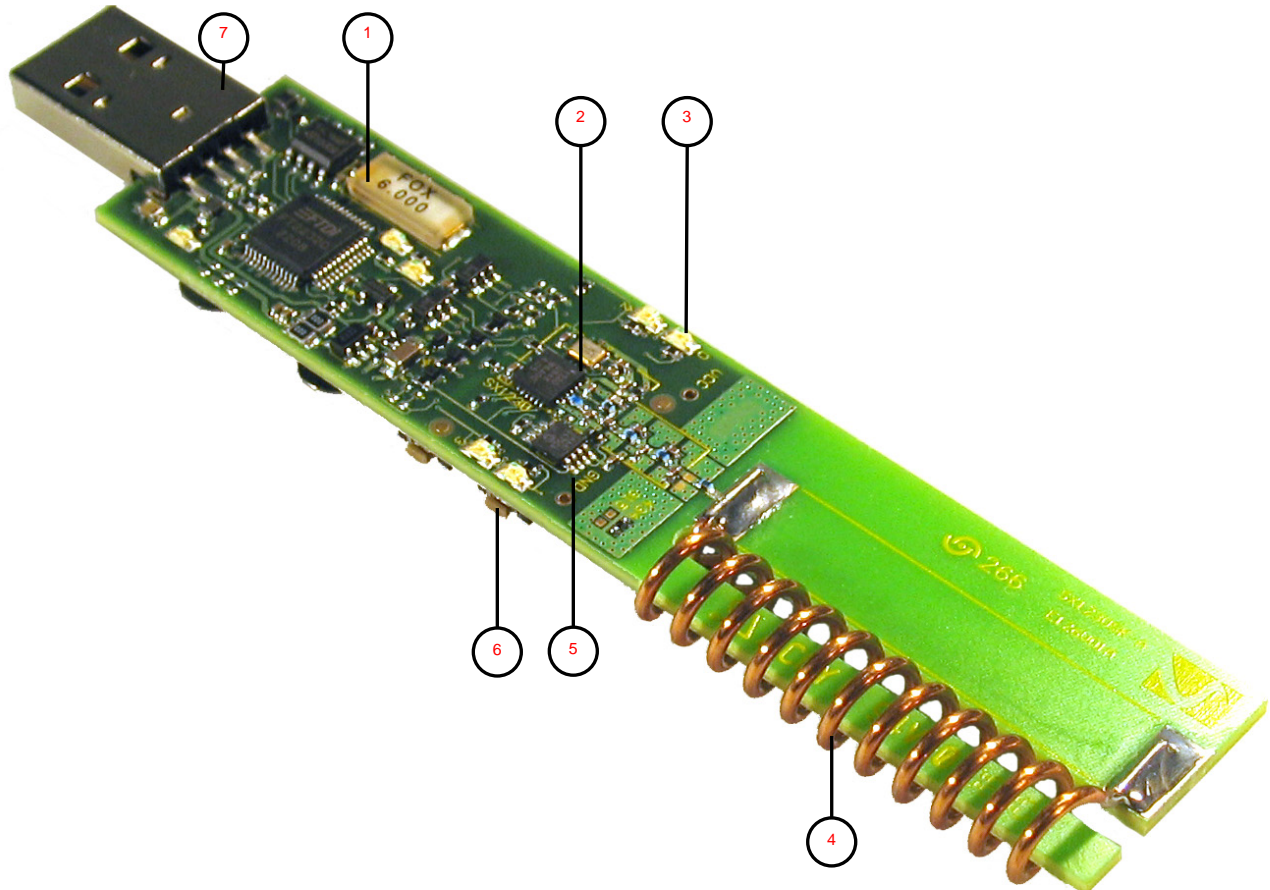

Figure 4: SX1230SKA, 868 and 915 MHz Band, Board Picture

The SX1230SKA is a USB based evaluation tool, which sees the SX1230 reference design (2) connected to a host PC via an FTDI USB to SPI bridge (1) and USB type 'A' connection (7). The SX1230SKA can also operate with in stand alone mode when battery powered. In this mode the initial configuration of the radio is downloaded from the first 77 bytes of the companion E²PROM (5). In response to a user push button input (6) a specific payload may be transmitted. The LED (3) corresponding to that button press illuminates to indicate transmission.

For operation in the 434 MHz band the RF link between SX1230SKA and SX1212SKA is established through a PCB mounted helical antenna (4) to give a realistic impression of the range and other performances attainable in a miniaturised application.

3.2 SX1212SKA Overview

The SX1212SKA features the SX1212 reference design (1) and is also interfaced via an FTDI bridge (6) to the USB type 'A' interface (2) of a host PC. Unlike the SX1230SKA, it has no provision for operation disconnected from the USB port. Indication of transmission and reception is indicated on a pair of LEDs (4). Connection to the separate antenna is made through an SMA connector (3) which can also be useful for laboratory based testing.

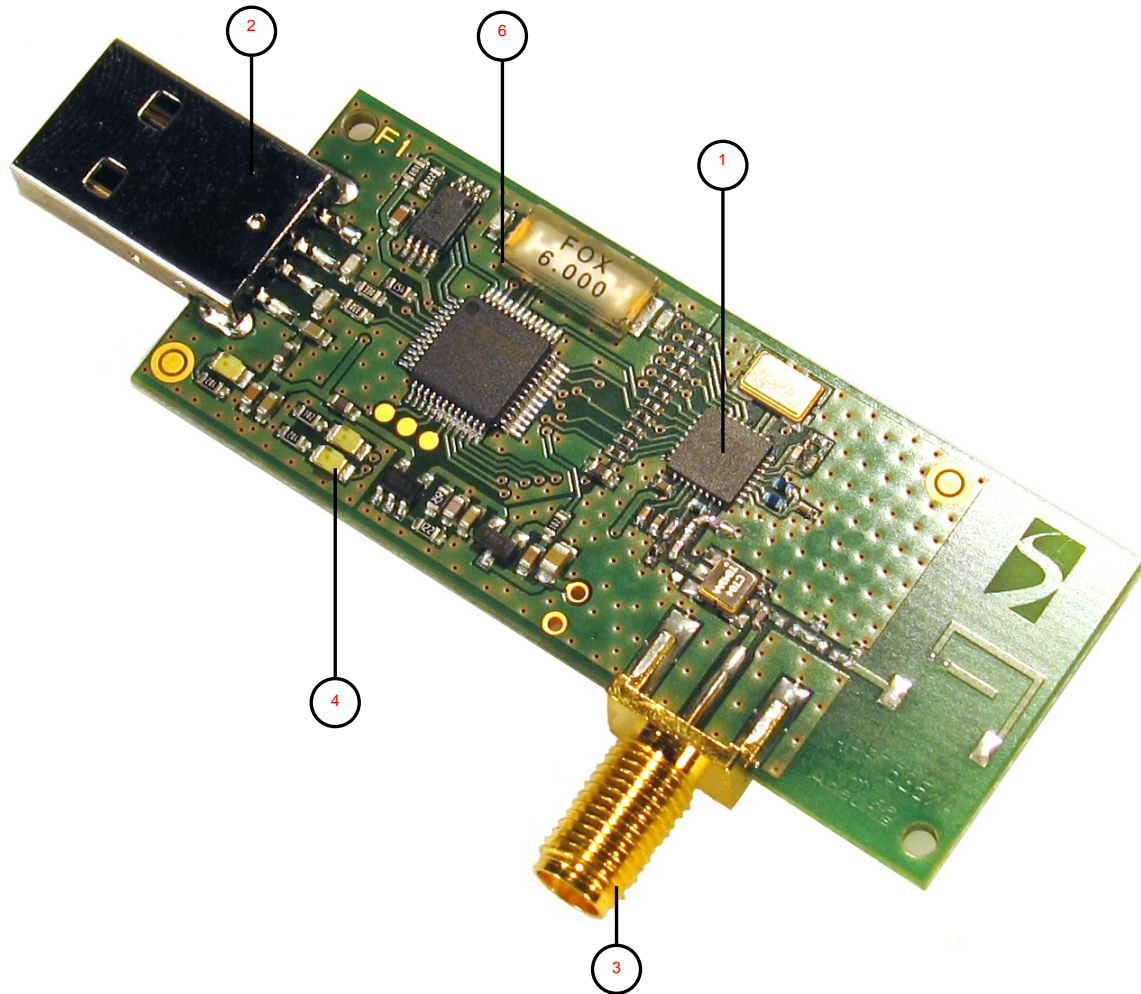



Figure 5: SX1212SKA Board Picture

4 Quick Start Guide: MCU Mode

With both SX1230SKA and SX1212SKA software installed, follow the sequence below to establish communication between the SX1230 as transmitter and the SX1212 as receiver.

4.1 SX1212SKA Quick Start

1. Plug the SX1212SKA into the USB port of the computer.
2. Run the SX1212 User Interface software Start > All Programs > SX1212SKA > SX1212SKA
3. The SX1212SKA should connect automatically to the User Interface Software. If not, then click on the USB connect short-cut button, located in the top left hand corner of the window. 
4. Once connected the SX1212SKA shows the default configuration of the SX1212 register settings upon power-up.

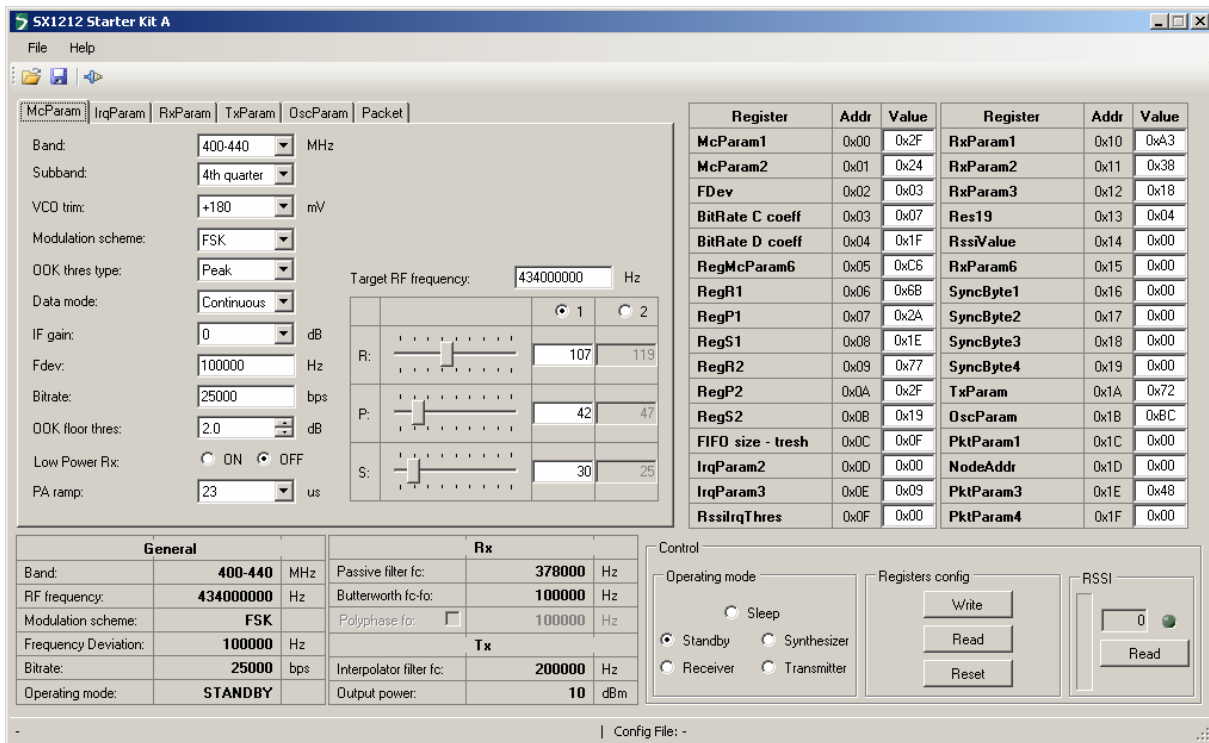

The screenshot shows the SX1212 Starter Kit A software interface. The main window is titled "SX1212 Starter Kit A" and contains several sections:

- Configuration Parameters:** Includes fields for Band (400-440 MHz), Subband (4th quarter), VCO trim (+180 mV), Modulation scheme (FSK), OOK thres type (Peak), Data mode (Continuous), IF gain (0 dB), Fdev (100000 Hz), Bitrate (25000 bps), OOK floor thres (2.0 dB), Low Power Rx (OFF), and PA ramp (23 us).
- Target RF frequency:** Set to 434000000 Hz.
- RF Characteristics:** Three plots for R (107), P (42), and S (30) with corresponding dBm values (119, 47, 25).
- Register Table:** A table listing registers and their values.

Register	Addr	Value	Register	Addr	Value
McParam1	0x00	0x2F	RxParam1	0x10	0xA3
McParam2	0x01	0x24	RxParam2	0x11	0x38
FDev	0x02	0x03	RxParam3	0x12	0x18
BitRate C coeff	0x03	0x07	Res19	0x13	0x04
BitRate D coeff	0x04	0x1F	RssiValue	0x14	0x00
RegMcParam6	0x05	0xC6	RxParam6	0x15	0x00
RegR1	0x06	0x68	SyncByte1	0x16	0x00
RegP1	0x07	0x2A	SyncByte2	0x17	0x00
RegS1	0x08	0x1E	SyncByte3	0x18	0x00
RegR2	0x09	0x77	SyncByte4	0x19	0x00
RegP2	0x0A	0x2F	TxParam	0x1A	0x72
RegS2	0x0B	0x19	OscParam	0x1B	0xBC
FIFO size - tresh	0x0C	0x0F	PktParam1	0x1C	0x00
IrqParam2	0x0D	0x00	NodeAddr	0x1D	0x00
IrqParam3	0x0E	0x09	PktParam3	0x1E	0x48
RssiIqThres	0x0F	0x00	PktParam4	0x1F	0x00
- Summary Tables:**
 - General:** Band: 400-440 MHz, RF frequency: 434000000 Hz, Modulation scheme: FSK, Frequency Deviation: 100000 Hz, Bitrate: 25000 bps, Operating mode: STANDBY.
 - Rx:** Passive filter fc: 378000 Hz, Butterworth fc-fc: 100000 Hz, Polyphase fc: 100000 Hz.
 - Tx:** Interpolator filter fc: 200000 Hz, Output power: 10 dBm.
- Control:** Operating mode (Standby selected), Registers config (Write, Read, Reset buttons), and RSSI (Read button).

Figure 6. SX1212 User Interface, Default Settings

5. Once connected the SX1212SKA shows the default configuration of the SX1212 register settings upon power-up (as shown in Figure 6).

6. The settings for communication between SX1212SKA and SX1230 SKA are located on the installation CD-ROM provided with the kit. Use the File > Open from the menu bar, or the open short-cut button to load a configuration file.



7. Load the "434_SX1212_pingpong.cfg" file from the "SX1212 Demo Files" folder on the CD-ROM.

8. The display will then appear as shown in Figure 7. These are the link parameters which match those which will be programmed to the SX1230SKA.

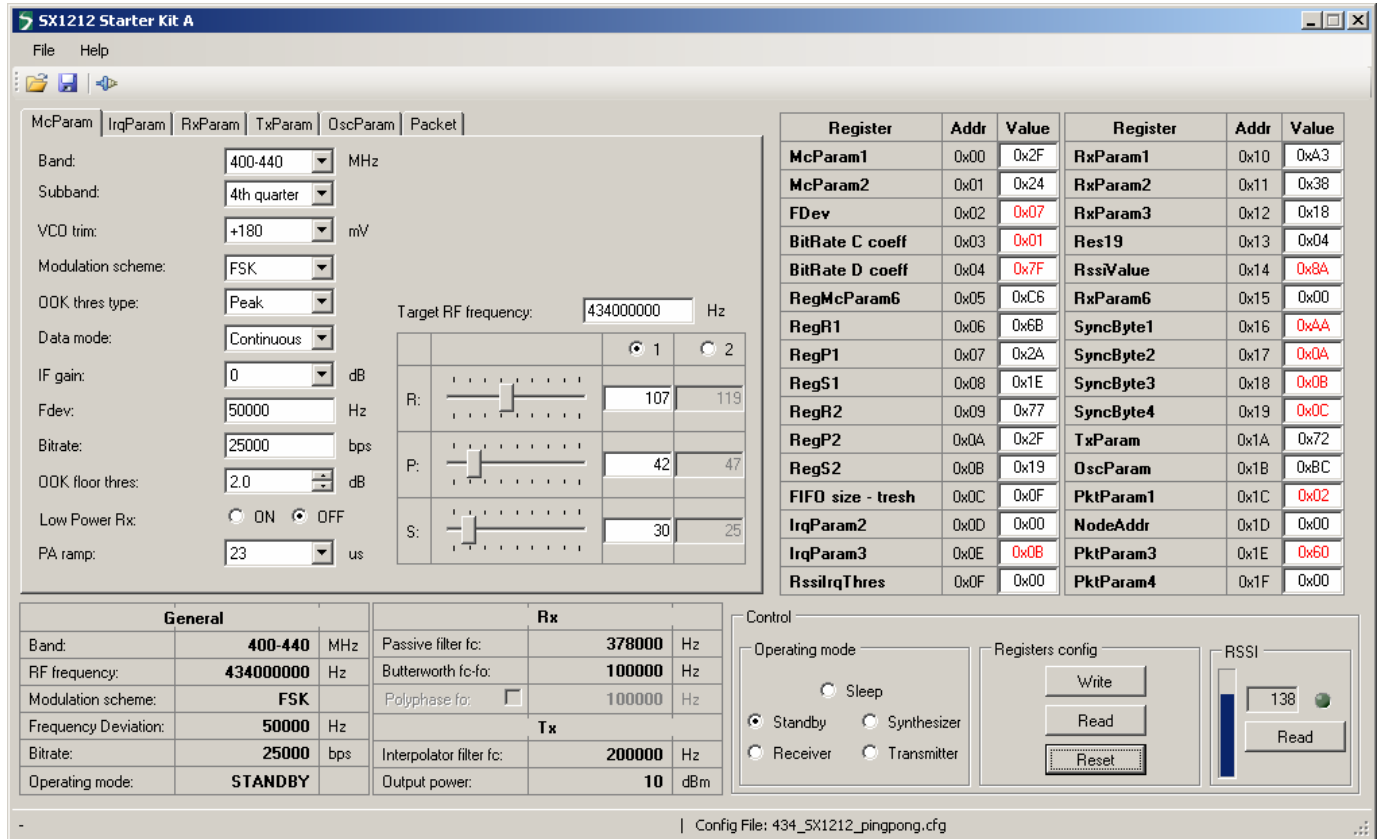

The screenshot shows the 'SX1212 Starter Kit A' software interface. It features several configuration tabs: McParam, IrqParam, RxParam, TxParam, OscParam, and Packet. The 'McParam' tab is active, displaying various radio parameters such as Band (400-440 MHz), Subband (4th quarter), VCO trim (+180 mV), Modulation scheme (FSK), DOK thres type (Peak), Data mode (Continuous), IF gain (0 dB), Fdev (50000 Hz), Bitrate (25000 bps), DOK floor thres (2.0 dB), Low Power Rx (OFF), and PA ramp (23 us). A 'Target RF frequency' field is set to 434000000 Hz. Below these are three frequency sliders for R (107/119), P (42/47), and S (30/25). A summary table at the bottom left lists 'General' (Band: 400-440 MHz, RF frequency: 434000000 Hz, Modulation scheme: FSK, Frequency Deviation: 50000 Hz, Bitrate: 25000 bps, Operating mode: STANDBY) and 'Rx' (Passive filter fc: 378000 Hz, Butterworth fc-fc: 100000 Hz, Polyphase fc: 100000 Hz, Interpolator filter fc: 200000 Hz, Output power: 10 dBm) parameters. A 'Registers config' table on the right lists 16 registers with their addresses and values, some of which are highlighted in red. A 'Control' section at the bottom right includes 'Operating mode' (Sleep, Standby, Receiver, Synthesizer, Transmitter), 'Registers config' (Write, Read, Reset buttons), and an 'RSSI' indicator showing 138 dBm.

Register	Addr	Value	Register	Addr	Value
McParam1	0x00	0x2F	RxParam1	0x10	0xA3
McParam2	0x01	0x24	RxParam2	0x11	0x38
FDev	0x02	0x07	RxParam3	0x12	0x18
BitRate C coeff	0x03	0x01	Res19	0x13	0x04
BitRate D coeff	0x04	0x7F	RssiValue	0x14	0x8A
RegMcParam6	0x05	0xC6	RxParam6	0x15	0x00
RegR1	0x06	0x6B	SyncByte1	0x16	0xAA
RegP1	0x07	0x2A	SyncByte2	0x17	0xDA
RegS1	0x08	0x1E	SyncByte3	0x18	0x0B
RegR2	0x09	0x77	SyncByte4	0x19	0x0C
RegP2	0x0A	0x2F	TxParam	0x1A	0x72
RegS2	0x0B	0x19	OscParam	0x1B	0x8C
FIFO size - tresh	0x0C	0x0F	PktParam1	0x1C	0x02
IrqParam2	0x0D	0x00	NodeAddr	0x1D	0x00
IrqParam3	0x0E	0x0B	PktParam3	0x1E	0x60
RssiIrqThres	0x0F	0x00	PktParam4	0x1F	0x00

Figure 7. The New SX1212 Configuration: Ready to be Written

9. By clicking on the write button in the 'Registers config' section, the new register values are written to the SX1212 registers. If successful, the red values in the hexadecimal register summary table will turn black. As a double check, the register read button may be pressed – the values presented on the user interface should remain unchanged.

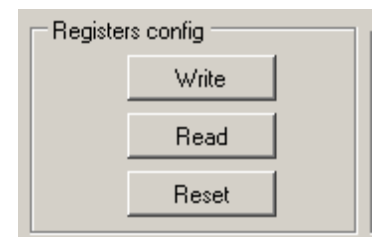

10. Click on the 'Packet' tab to access the packet testing portion of the program. Within this window a pre-defined packet structure is already configured. It remains simply to click the 'Reception' radio button and press the Start button. At this point the SX1212SKA enters packet receive mode and is now listening for valid packets. At this juncture the SX1230SKA transmitter must be configured.

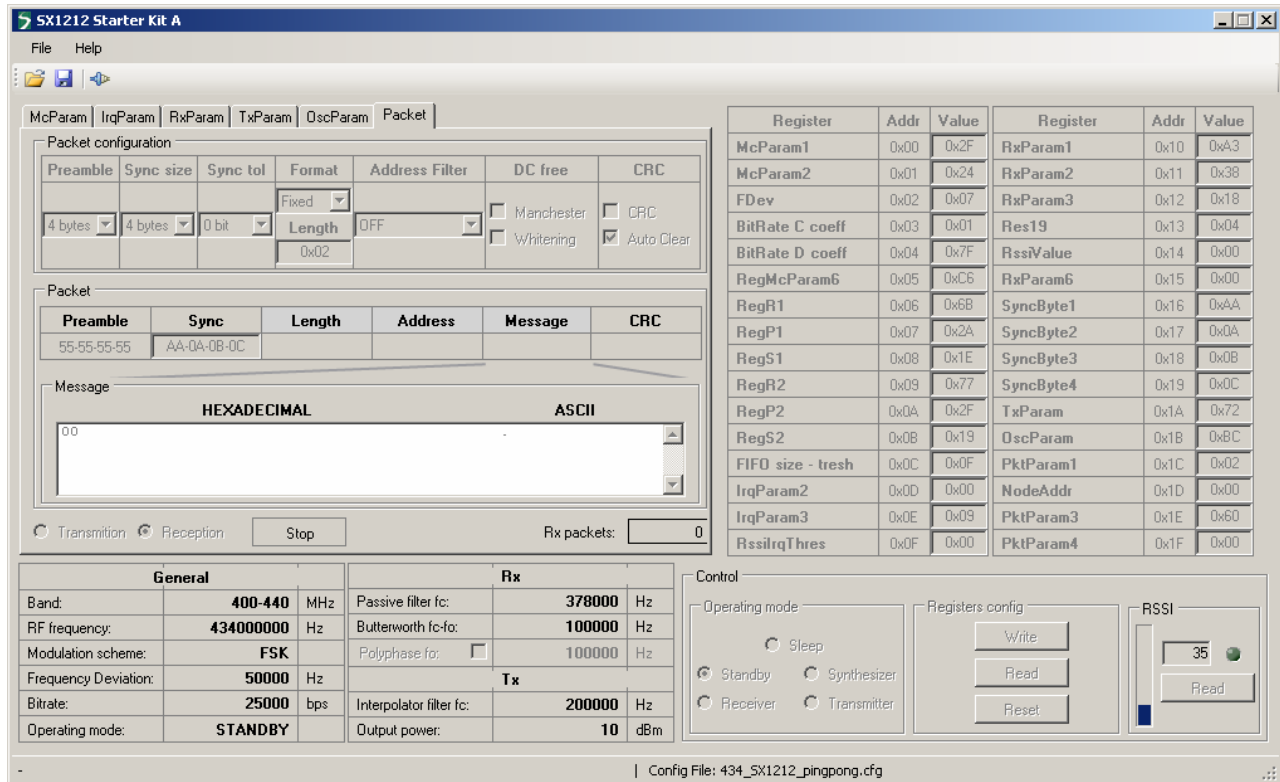



Figure 8. The SX1212SKA User Interface whilst in Packet Receiver Mode

4.2 SX1230SKA Quick Start

1. Plug the SX1230SKA into the USB port of the computer.
2. Run the SX1230 User Interface software Start > All Programs > SX1230SKA > SX1230SKA
3. The SX1230SKA should connect automatically to the User Interface Software. If not, then click on the USB connect short-cut button, located in the top left hand corner of the window.
 
4. Once connected the SX1230SKA shows the default configuration of the SX1230 register settings upon power-up (see Figure 9).

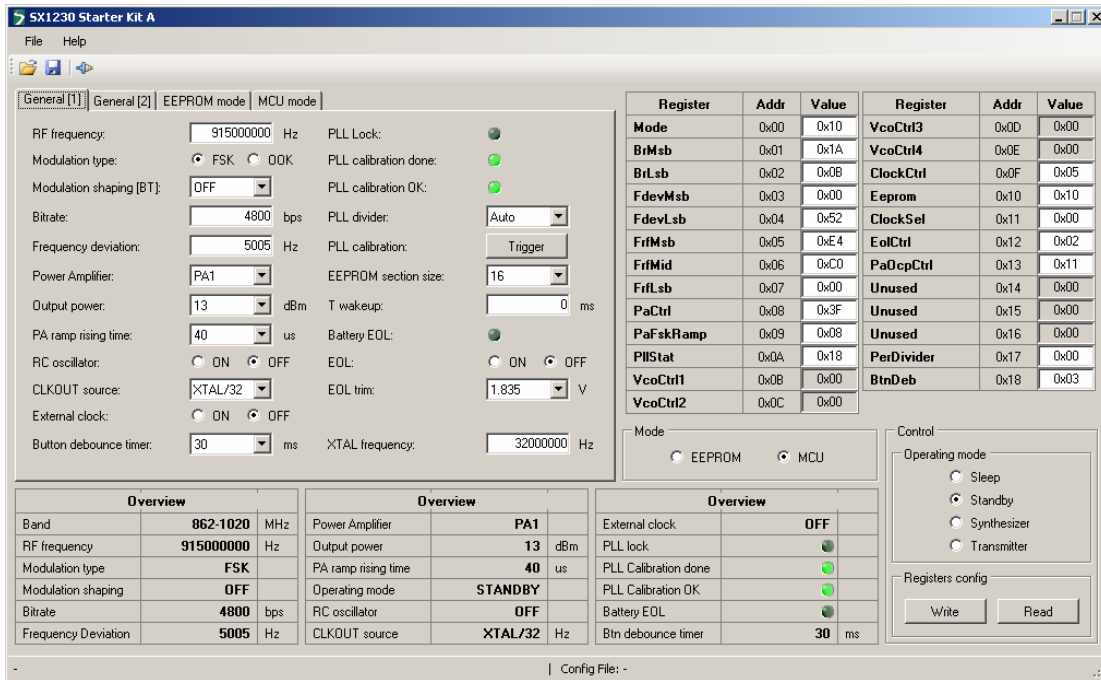

Figure 9. SX1230 User Interface, Default Settings

- The settings for communication between SX1212SKA and SX1230SKA are located on the installation CD-ROM provided with the kit. Use the File > Open from the menu bar, or the open short-cut button to load a configuration file.
- Load the "434_SX1230_pingpong.cfg" file from the "SX1230 Demo Files" folder on the CD-ROM.
- The display will then appear as shown in Figure 10. These are the link parameters which match those which will be programmed to the SX1212SKA.



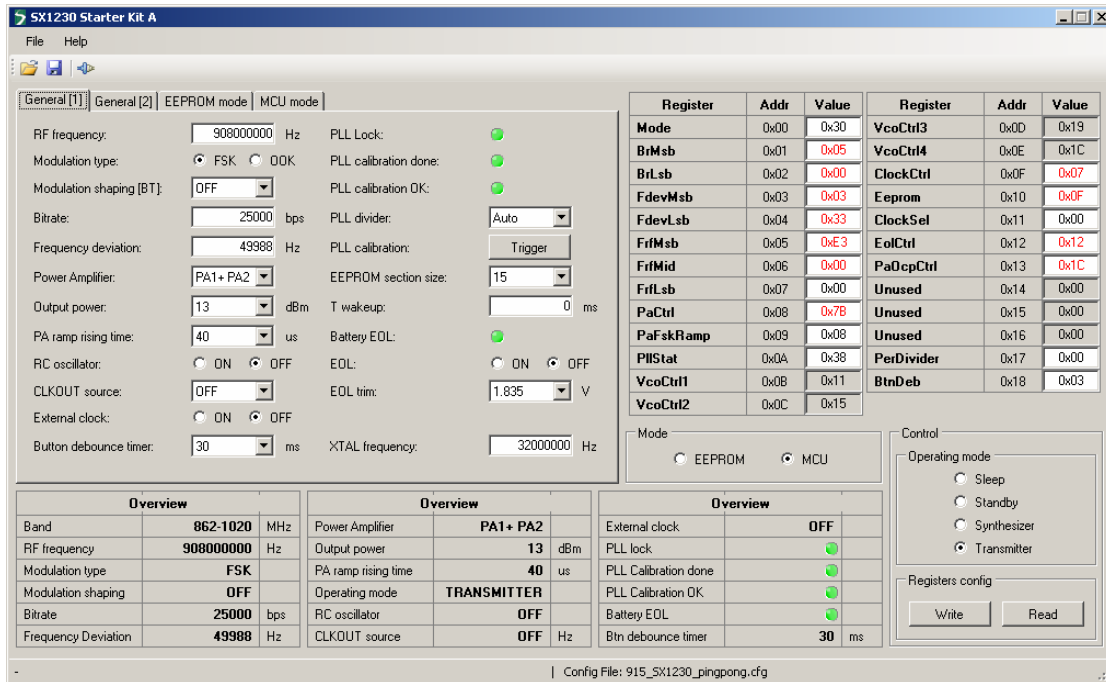

Figure 10. The New SX1230 Configuration: Ready to be Written

- By clicking on the write button in the 'Registers config' section, the new register values are written to the SX1230 registers. If successful, the red values in the hexadecimal register summary table will turn black. As a double check, the register read button may be pressed – the values presented on the user interface should remain unchanged.



- Once successfully configured, the SX1230 must be placed in packet transmission mode. This is done by selecting the 'MCU mode' tab – note that a pre-configured frame format identical to that for the SX1212SKA is already entered into the display. It suffices simply to click on the 'Start' button to begin continuous transmission of this frame. For clarity a screenshot illustrating the display during transmission is shown in Figure 11.

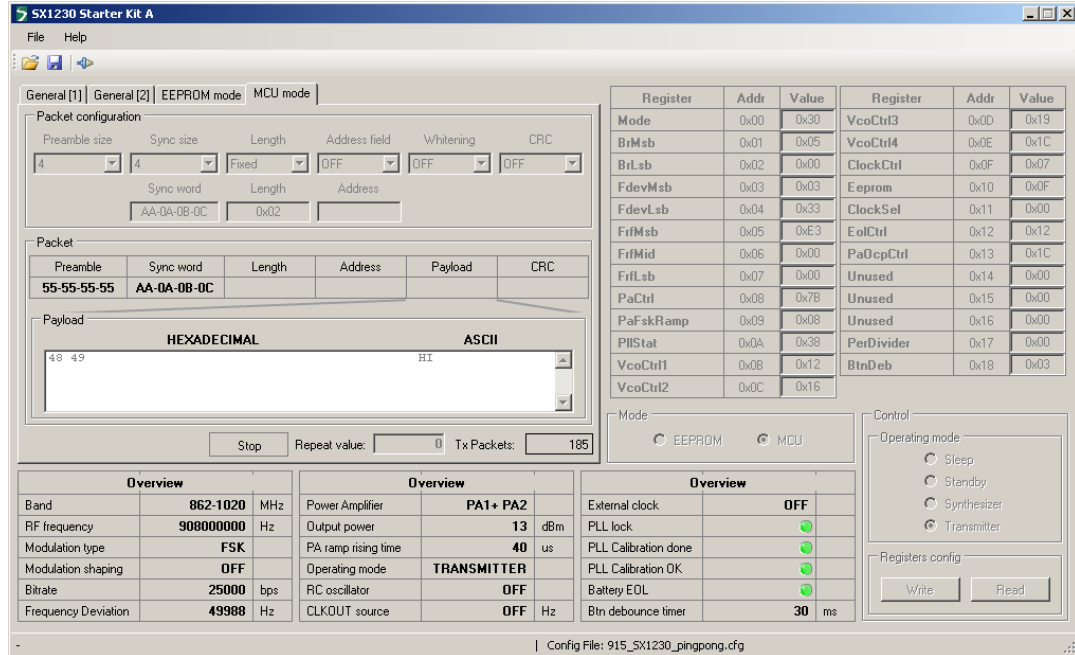

Figure 11. SX1230 During MCU Mode Packet Transmission

4.3 Link Test

With both devices configured as described in the preceding two sections, reception of valid packets by the SX1212 should be visible. Note that during link testing be sure that the USB kits are separated by several cm. Note also, that it is possible to install the SX1212SKA user interface on one machine and the SX1230SKA user interface on another allowing range test evaluation with full control over the link parameters.

Where a pair of computers is not available, the SX1230SKA can be configured in stand alone mode. Please see the next section for a quick start guide on operation of the SX1230SKA in this mode.

5 Quick Start Guide: Stand Alone Mode

5.1 SX1212SKA Configuration

Initiation of the SX1212SKA for operation in Stand Alone Mode is identical to that described in Section 4.1. Please configure the SX1212SKA as described therein and refer to the following section for configuration of the SX1230.

5.2 SX1230SKA Configuration

There are a few simple steps to follow to configure the SX1230SKA for stand alone mode operation. Figure 12 shows both top and bottom views of the SX1230SKA hardware. The SX1230SKA companion EEPROM comes pre-programmed with a band specific configuration file already loaded.

1. Insert the CR2032 button cell into the cell holder (1), taking care to respect the polarity. Note that there is some quiescent current drain caused by the USB interface, so to maximise battery life ensure this is removed when not in use.
2. Three of the four push buttons (labeled 0 to 3 on the PCB silkscreen) are connected to the general purpose digital inputs of the SX1230. The button labeled 3 is configured as a reset button. Push this button following connection of the cell. There should now be no LEDs illuminated on the SX1230SKA.

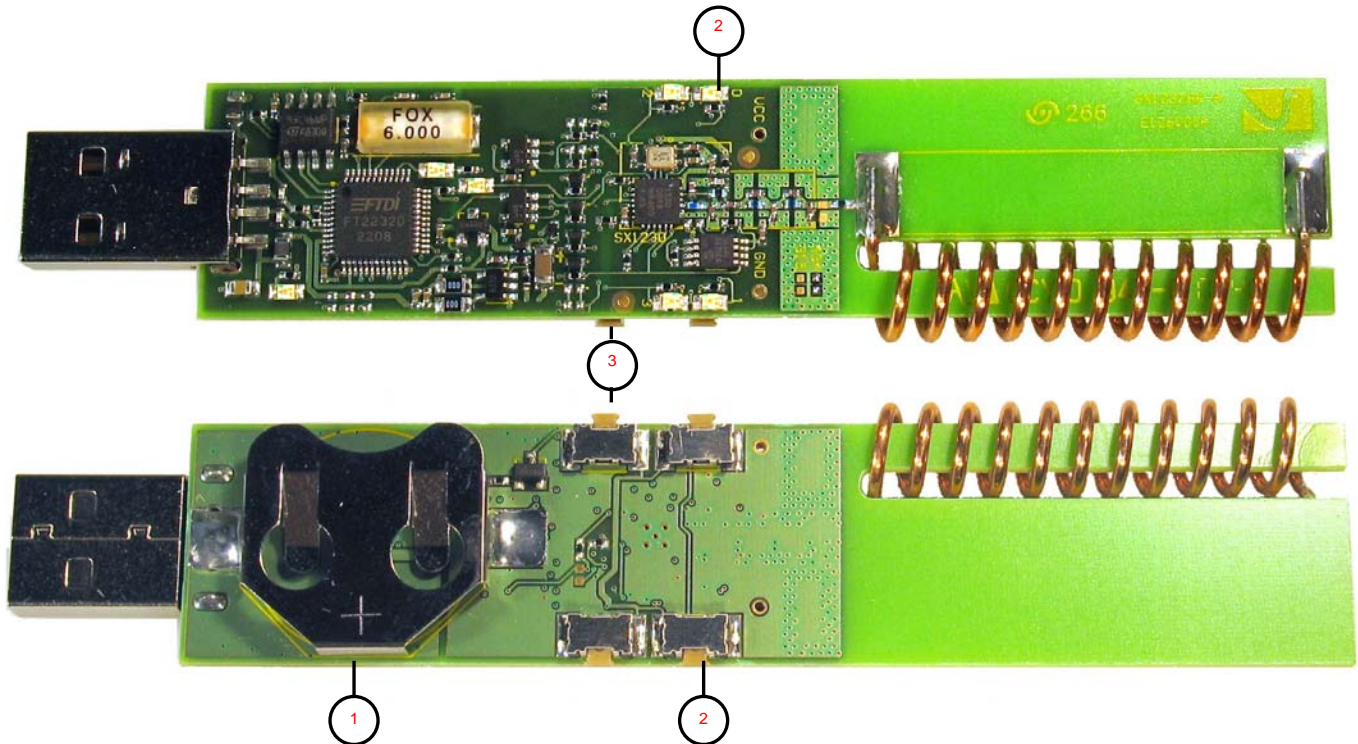

Figure 12. Hardware for E²PROM (Stand Alone) Operation

3. The SX1230SKA is not ready to be used in conjunction with the SX1212SKA in frame reception mode, as described in Section 4.1.

5.3 Link Test

Each push button has the same payload mapped to it. Push button 0 transmits this single, standard format frame, once. Push button 1 has a demonstration of packet repetition. Here the packet is programmed to be resent five times. Note that the SX1212SKA may not receive all five frames successfully. This is due to the time required to empty the FIFO, whereas SX1230 will transmit all five frames in quick succession. Finally, push button 2 gives a demonstration of periodic mode. Here the frame is configured to repeat several times a second whilst the push button is held down.

To modify the E²PROM contents please see Section 6.7. Note also that the original quick start configuration is included on the CD. Please also refer to Section 6.7 on how to load a non-volatile memory configuration file and program the E²PROM.

Otherwise, guidance for performing link testing is the same as that already given in Section 4.3.

6 SX1230SKA Software Description

6.1 Overview

Figure 13 shows the SX1230SKA graphical user interface (GUI). Each of the numbers surrounding the display corresponds to the Chapter within this section gives the description of that feature.

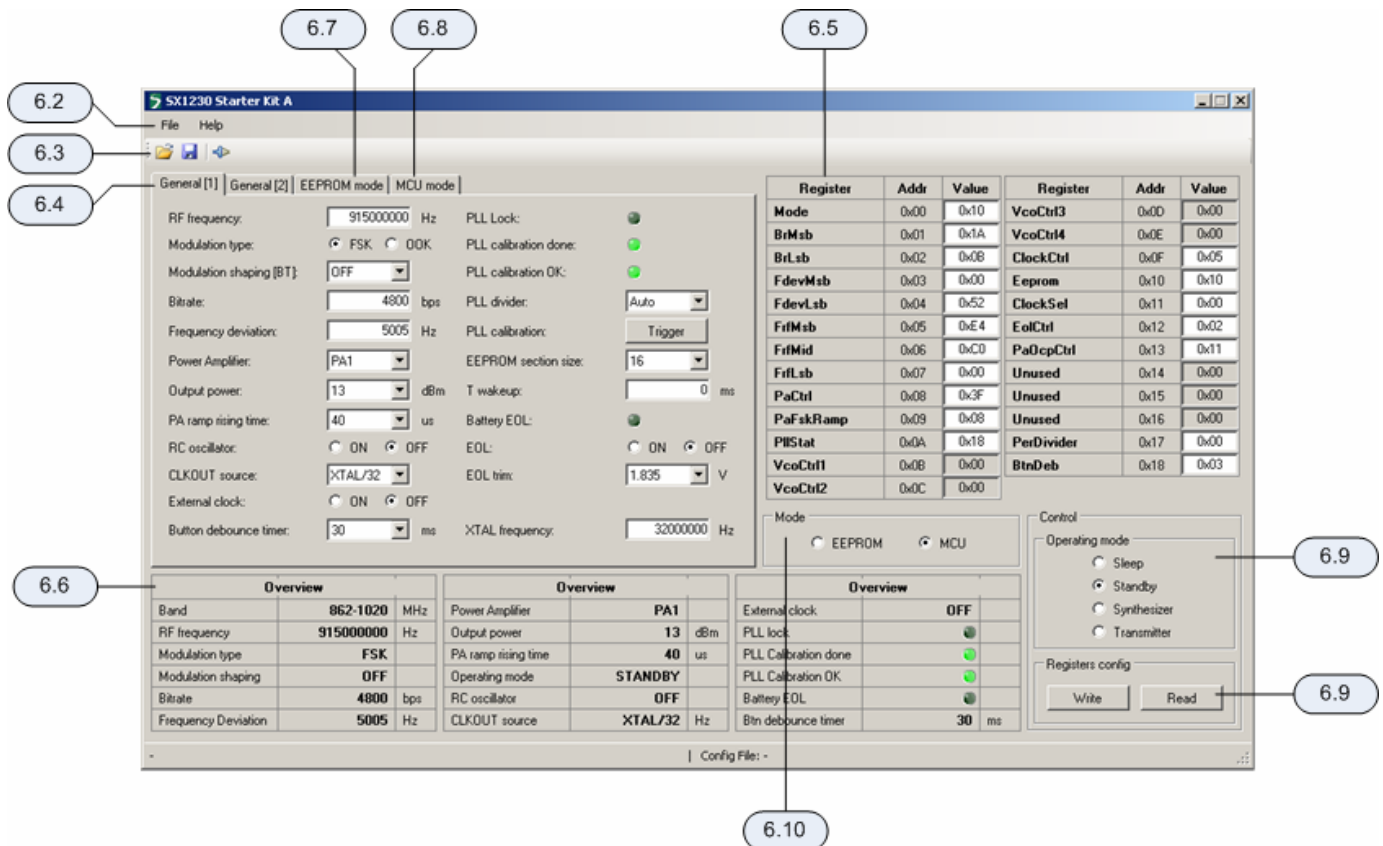
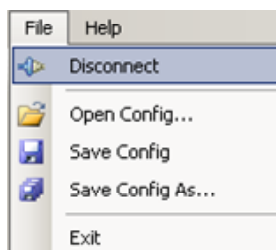

Figure 13: SX1230SKA GUI Overview and References to the User Guide Description of this Chapter.

6.2 File Menu



File menu contains some general purpose functions. The first feature in the list provides the possibility of connecting or disconnecting to the USB kit. Care must be taken to ensure that the USB port is closed before unplugging the USB kit. This functionality may also be accessed through the short cut buttons (see Section 6.3).

The possibility of opening configuration files and saving the present configuration is also provided. This is done through a standard Windows file dialog box.

The Help menu contains two menu items. The first item provides a link to this user guide in PDF format. The second, 'About SX1230 Starter kit...', gives information in the revision of the software installed.

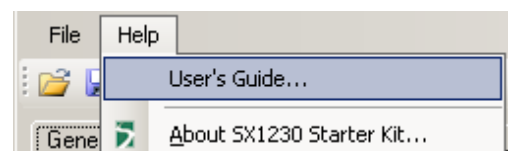

6.3 Shortcut Buttons

The shortcut buttons provide identical functionality to those listed under the file menu



The configuration 'file open' shortcut button. This opens a windows file dialog box to allow access to previously saved SX1230 register configuration files.

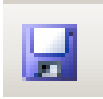

The 'save' configuration file shortcut button immediately saves and overwrites the existing configuration file.



The 'connect / disconnect' button allows the user to manage manually connection and disconnection of the kit. Note that any time the SX1230SKA is to be removed from the system; the kit must first be disconnected.

The saved configuration files are designed to be a useful tool for embedded software development. The file can be opened in any text editor to display the programmed register name, address and hexadecimal value programmed to that address.

```

File Edit Format View Help
#Type Register Name Address [Hex] Value [Hex]
REG Mode 0x00 0x30
REG BrMsb 0x01 0x05
REG BrLsb 0x02 0x00
REG FdevMsb 0x03 0x03
REG FdevLsb 0x04 0x33
REG FrfMsb 0x05 0xE3
REG FrfMid 0x06 0x00
REG FrfLsb 0x07 0x00
REG PaCtrl 0x08 0x7B
REG PaFskRamp 0x09 0x08
REG PllStat 0x0A 0x38
REG VcoCtrl1 0x0B 0x12
REG VcoCtrl2 0x0C 0x16
REG VcoCtrl3 0x0D 0x19
REG VcoCtrl4 0x0E 0x1C
REG ClockCtrl 0x0F 0x07
REG Eeprom 0x10 0x0F
REG ClockSel 0x11 0x00
REG EolCtrl 0x12 0x12
REG PaOcpCtrl 0x13 0x1C
REG Unused 0x14 0x00
REG Unused 0x15 0x00
REG Unused 0x16 0x00
REG PerDivider 0x17 0x00
REG BtnDeb 0x18 0x03
PKT 4;4;1;0;0;0;AA-0A-0B-0C;2;0;48,49
  
```

Figure 14. Example Text Editor Output of the SX1230 Configuration File

6.4 General Configuration Tabs

For clarity and ease of use the general configuration settings have been split between two tabs.

6.4.1 General [1]

The most commonly used configuration parameters are located on the General [1] tab. Each field is directly editable by the user and is refreshed every time a register read or write is performed.

Figure 15. The General Configuration Tab Features the most Commonly Used Configuration Parameters

Where the data entry field allows direct keyboard entry, the following background highlight conventions are used to aid the user in their choice of programmed value:

RF frequency: Hz

An orange background highlight indicates that the precise value entered into the data entry field is not directly addressable by the SX1230. Instead the closest (rounded) value will be used.

RF frequency: Hz

Conversely a red background highlight indicates where the maximum or minimum value for that register parameter has been exceeded.

Each data entry field and user control of the General [1] tab is described below.

RF Frequency

RF frequency: Hz

The RF frequency field accepts a numerical text input from the keyboard. Values in any one of the three frequency bands from 290 to 1020 MHz are permitted. Please note that the entry units are Hz.

Modulation Type

Modulation type: FSK OOK

The SX1230 is capable of both FSK and OOK modulation, they are selectable through the user interface by clicking with the mouse on the appropriate radio button.

Modulation Shaping

Modulation shaping [BT]:

The Tx bit-stream may be pre-filtered before modulation. Varying strengths of filtering are accessible. The filter type also depends upon the type of modulation used. Filter coefficients are selectable from a drop-down menu.

Bitrate

Bitrate: bps

The bit rate of the transmitted signal (in bps) can be directly edited in this data entry field.

Frequency Deviation

Frequency deviation: Hz

Text entry field for the frequency deviation when using FSK modulation.

Power Amplifier

Power Amplifier:

Selection of single (low power) or dual (high power) operation. Note that PAs 1 and 2 must be enabled for +17 dBm operation.

Output Power

Output power: dBm

The output power is selectable from a drop down list in the programmable 1 dB increments.

PA Ramping

PA ramp rising time: us

The PA ramp rise time is selectable from the list of programmable values.

Oscillator

RC oscillator: ON OFF
CLKOUT source:
External clock: ON OFF

Although not directly accessible from the SX1230SKA, for completeness, the source of the clock output signal can be selected and its frequency altered in accordance with the range of programmable divider values. For more information please consult the SX1230 datasheet.

Push Button Debouncer

Button debounce timer: ms

The four general purpose digital inputs – here connected to the four push buttons – has a variable debounce timer. Several common values are accessible from a drop down menu.

PLL Lock Detection Parameters

PLL Lock:

PLL calibration done:

PLL calibration OK:

PLL divider:

PLL calibration:

Three LED type indicators display the status of the SX1230 following the last register read cycle of the SX1230. Various options exist for changing the PLL divider ratio and triggering PLL calibration. Please consult the SX1230 datasheet for a more detailed description.

E²PROM Mode Parameters

EEPROM section size:

T wakeup: ms

These two register settings are used to determine the size of each section in the E²PROM memory and the wake-up time if periodic mode is enabled respectively. Please see Section 6.7, in conjunction with the SX1230 datasheet, for a description of how to use these E²PROM parameters.

Low Battery Detection Parameters

Battery EOL:

EOL: ON OFF

EOL trim: V

The battery end of life (EOL) indicator is set if the EOL is enabled (here controlled by a radio button input) and the supply voltage passes the corresponding threshold – EOL trim.

Crystal Frequency

XTAL frequency: Hz

Most of the programmable communication setting parameters are a function of the crystal frequency used. This field allows other crystal frequencies to be tried, however, the SX1230SKA comes fitted with a 32 MHz crystal. The value should hence not be changed.

6.4.2 General [2]

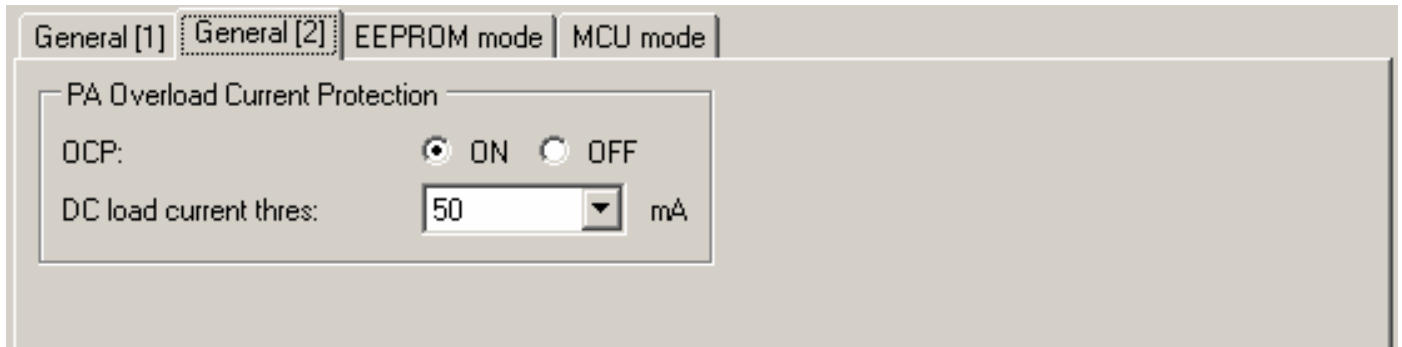

Figure 16. Second Page of the General Configuration Parameters

The second page of general configuration settings (see *Figure 16*) contains the user inputs for enabling of the power amplifier over current protection (OCP) and setting the current limit from a drop down menu. The current limit must be increased to 100 mA or higher for operation of the SX1230 at the maximum output power of +17 dBm.

6.5 Register Hexadecimal Display

Figure 17 shows the register summary of the SX1230. In addition to manual user entry in the fields described in the previous section, direct hexadecimal entries may be made into the register display. Note that values yet to be written to the SX1230 registers appear in red. Note, also, that for full control flexibility, incorrect (red) values entered in the hexadecimal section *will still be written* in the event of a register 'write'. So care must be exercised when editing the hexadecimal values.

Register	Addr	Value	Register	Addr	Value
Mode	0x00	0x10	VcoCtrl3	0x0D	0x19
BrMsb	0x01	0x1A	VcoCtrl4	0x0E	0x1C
BrLsb	0x02	0x0B	ClockCtrl	0x0F	0x05
FdevMsb	0x03	0x01	Eeprom	0x10	0x10
FdevLsb	0x04	0x52	ClockSel	0x11	0x00
FrfMsb	0x05	0xE4	EolCtrl	0x12	0x12
FrfMid	0x06	0xC0	PaOcpCtrl	0x13	0x1B
FrfLsb	0x07	0x00	Unused	0x14	0x00
PaCtrl	0x08	0x3F	Unused	0x15	0x00
PaFskRamp	0x09	0x08	Unused	0x16	0x00
PlIStat	0x0A	0x10	PerDivider	0x17	0x00
VcoCtrl1	0x0B	0x12	BtnDeb	0x18	0x03
VcoCtrl2	0x0C	0x16			

Figure 17. Register Hexadecimal Display

Note that values changed in this portion of the display cause the values in the tabbed configuration section to be changed dynamically.

6.6 Overview Panel

A summary of the values presently entered into the user interface software is shown in the overview display at the bottom of the screen. This covers all of the SX1230 register values, including those not displayed on the tab presently selected, and indicates the true value which will be written to the SX1230 configuration registers.

Overview			Overview			Overview		
Band	862-1020	MHz	Power Amplifier	PA1		External clock	OFF	
RF frequency	915000000	Hz	Output power	13	dBm	PLL lock	<input type="checkbox"/>	
Modulation type	FSK		PA ramp rising time	40	us	PLL Calibration done	<input checked="" type="checkbox"/>	
Modulation shaping	OFF		Operating mode	STANDBY		PLL Calibration OK	<input checked="" type="checkbox"/>	
Bitrate	4800	bps	RC oscillator	OFF		Battery EOL	<input type="checkbox"/>	
Frequency Deviation	5005	Hz	CLKOUT source	XTAL/32	Hz	Btn debounce timer	30	ms

Figure 18. The Configuration Overview Display

6.7 E²PROM Mode Tab

The E²PROM mode tab is used to configure the contents of the E²PROM for stand alone mode operation of the SX1230SKA. In this mode the SX1230 acts as SPI master and can download both configuration and payload information from an SPI E²PROM. The E²PROM memory map is shown below:

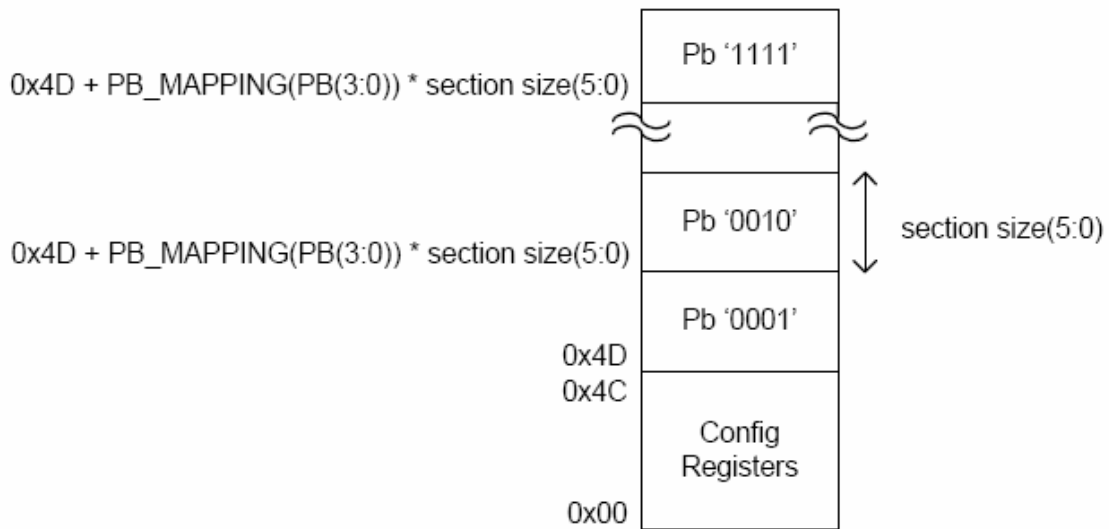

Figure 19. E²PROM Memory Mapping

The bottom 0x4C locations in the E²PROM are reserved general configuration information – configuration which is the same for every button press. The subsequent sections are then mapped to the remaining 15 possible combinations of the 4 digital inputs (for mapping details please see the SX1230 datasheet). These may contain either i) solely payload or ii) a combination of supplementary configuration information and payload.

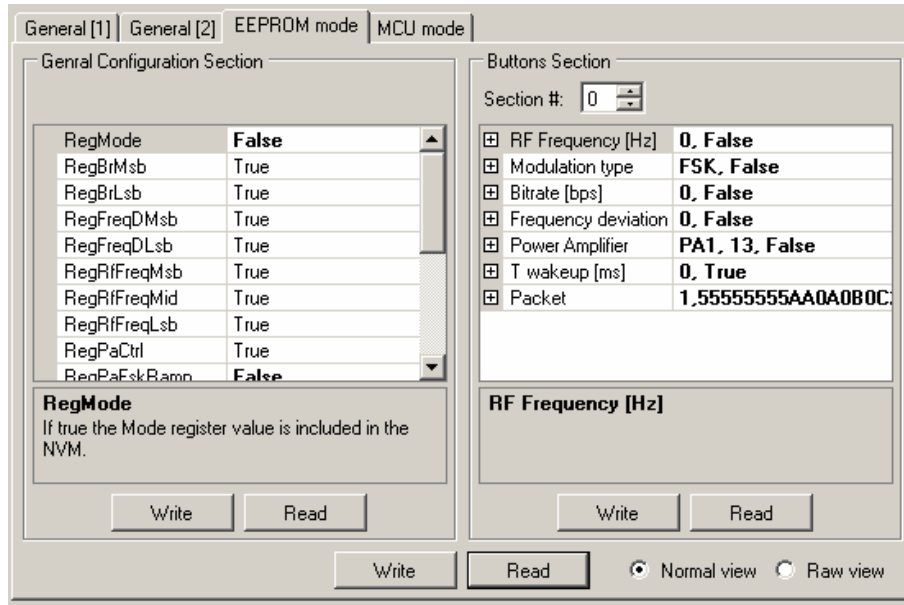

Figure 20. The E²PROM Mode Tab 'Normal View'

The E²PROM mode display is broken down into two types, selectable by the radio button control in the bottom right hand corner of the display. The default is 'Normal view' which shows the E²PROM contents in human readable format (see Figure 20). The left hand 'General Configuration Section' dictates which registers are to be written to the general configuration section – True indicating that the value will be written, False that it will not. The values written to the configuration section are taken from the General setting tabs of Sections 6.4.1 and 6.4.2. The general configuration settings may be read or written independently of the rest of the E²PROM contents by clicking the Read or Write button within the section.

The rightmost frame contains the contents of each of the input specific sections. The contents of a particular section are displayed individually. The section may be changed by entering the desired section in the 'Section #:' input. Several useful common parameters and the payload itself are listed within the 'Buttons' section. Each can be edited directly. The input specific section of the E²PROM memory can be written or read independently of the rest of the E²PROM contents by clicking on the write or read button within the Buttons Section.

At the bottom of the display are the controls for global read or write of the E²PROM contents. These cause the whole E²PROM to be read or written, respectively.

The radio button control in the bottom right hand corner allows selection between Normal and Raw views of the E²PROM contents.

An alternative perspective of the E²PROM contents is available in 'Raw view', illustrated in Figure 21. Here we see the E²PROM contents in hexadecimal (centre column) and ASCII (right column) versus the E²PROM address in hexadecimal (left column) in tabular format. Note also the addition of several short-cut buttons. These allow the user to save or recall E²PROM (.NVM – non volatile memory) files to or from disc storage. Copy, cut and paste functionality is also provided.

Once programmed the SX1230 may be disconnected from the USB port, unplugged and used in stand-alone mode. The SX1230SKA comes pre-programmed with an example E²PROM contents (see the quick start Section for more details).

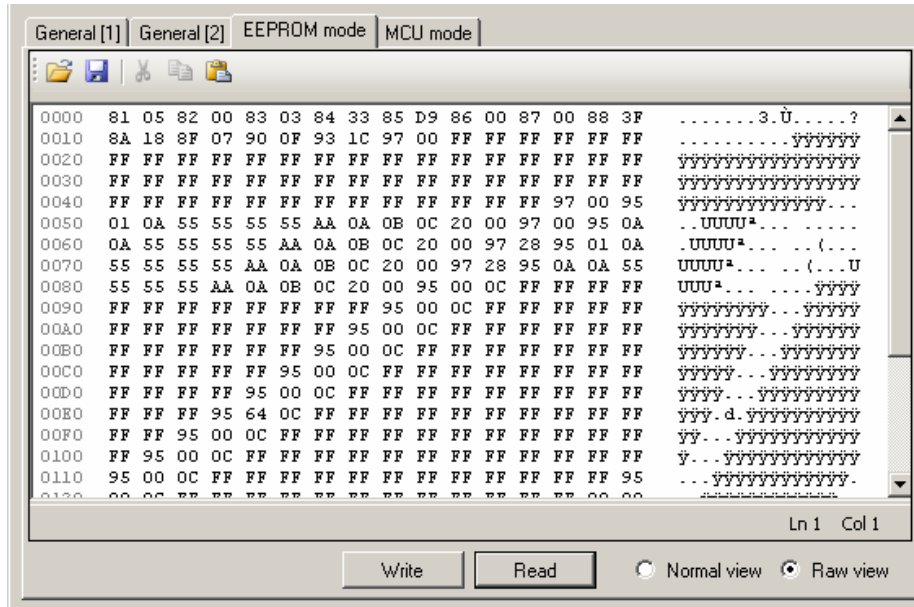

Figure 21. E²PROM Raw View

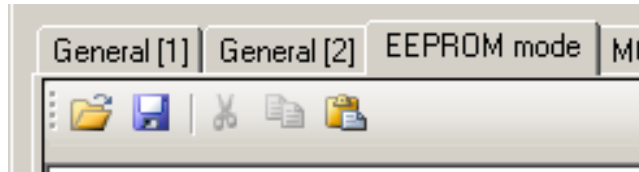

Figure 22. E²PROM Raw View Short-cut Buttons

6.8 MCU Mode Tab

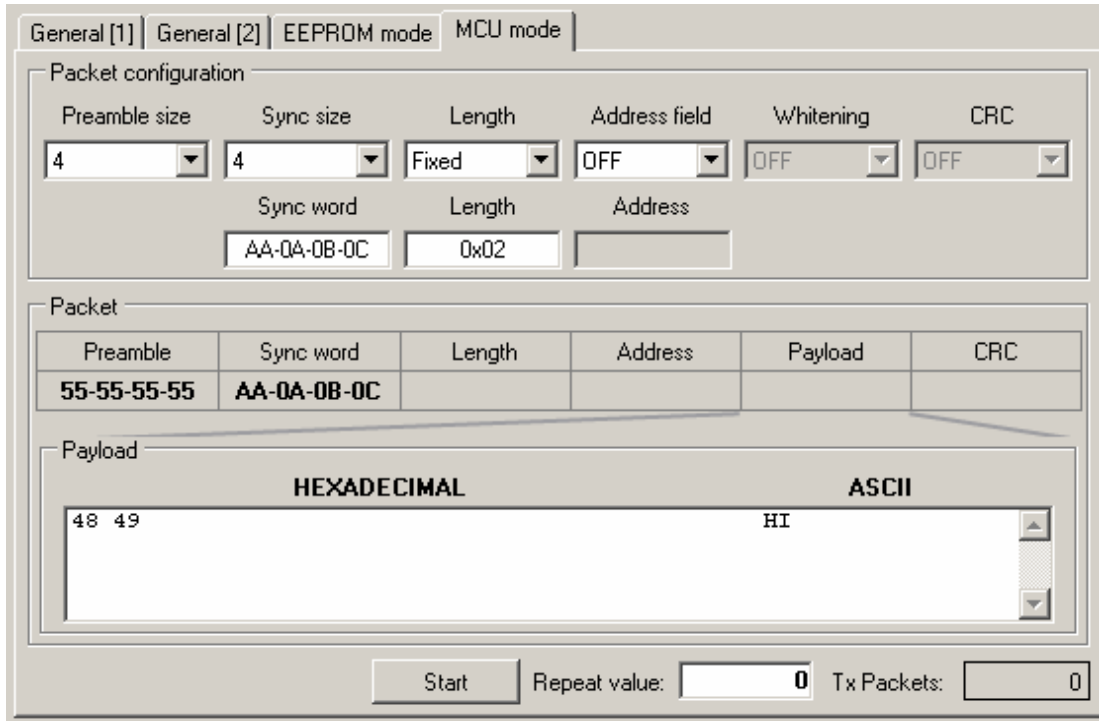

Figure 23. MCU Mode Tab Display

The MCU mode tab allows the user to define a custom packet for transmission by the SX1230SKA. The packet configuration section (top) allows the user enable and set the length of a pulse train preamble (sent at the data rate). A custom synchronisation word of up to 4 bytes may also be added. Fixed or variable length packets may also be stipulated (see the SX1212 datasheet for more information), as may an optional 1 byte address.

With these options entered the constructed packet is shown in the 'Packet' frame. The packet payload may also be edited in either ASCII or hexadecimal. Packet transmission starts when the 'Start' button is pressed. Either infinite transmission (repeat value = 0) or a finite number of packets may be transmitted by editing the repeat value.

6.9 The Mode Control Box



Figure 24. The Control Box

The control box gives access to the operating modes of the SX1230. By selecting one of the radio buttons, the SX1230 is immediately transferred into that mode without the need to read or write to the registers. The control for reading and writing to the registers is also within the control frame. The Read button will read the contents of the SX1230 configuration registers and display them in the hexadecimal, overview and tabbed configuration areas.

Similarly, a register write can be performed by clicking the write button. Here the contents of the hexadecimal display are written directly to the SX1230 configuration registers.

Note that the E²PROM contents cannot be manipulated from this section instead see Section 6.7.

6.10 MCU / E²PROM Mode Selection

In the frame labeled 'Mode' either MCU or Stand Alone (E²PROM) operation can be selected. This allows the stand alone mode to be entered whilst connected to the USB port. Note that transition to and from E²PROM mode generates a hardware reset (transition cannot be made dynamically) and so the register contents of the SX1230 will be lost upon transition.

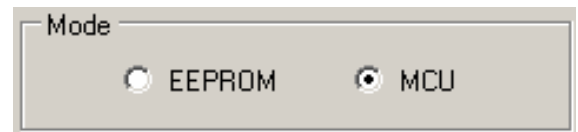

7 SX1212SKA Software Description

7.1 Overview

Figure 25 shows the SX1212SKA graphical user interface. Each of the numbers surrounding the display corresponds to the Chapter within this section which corresponds to the description of that GUI feature.

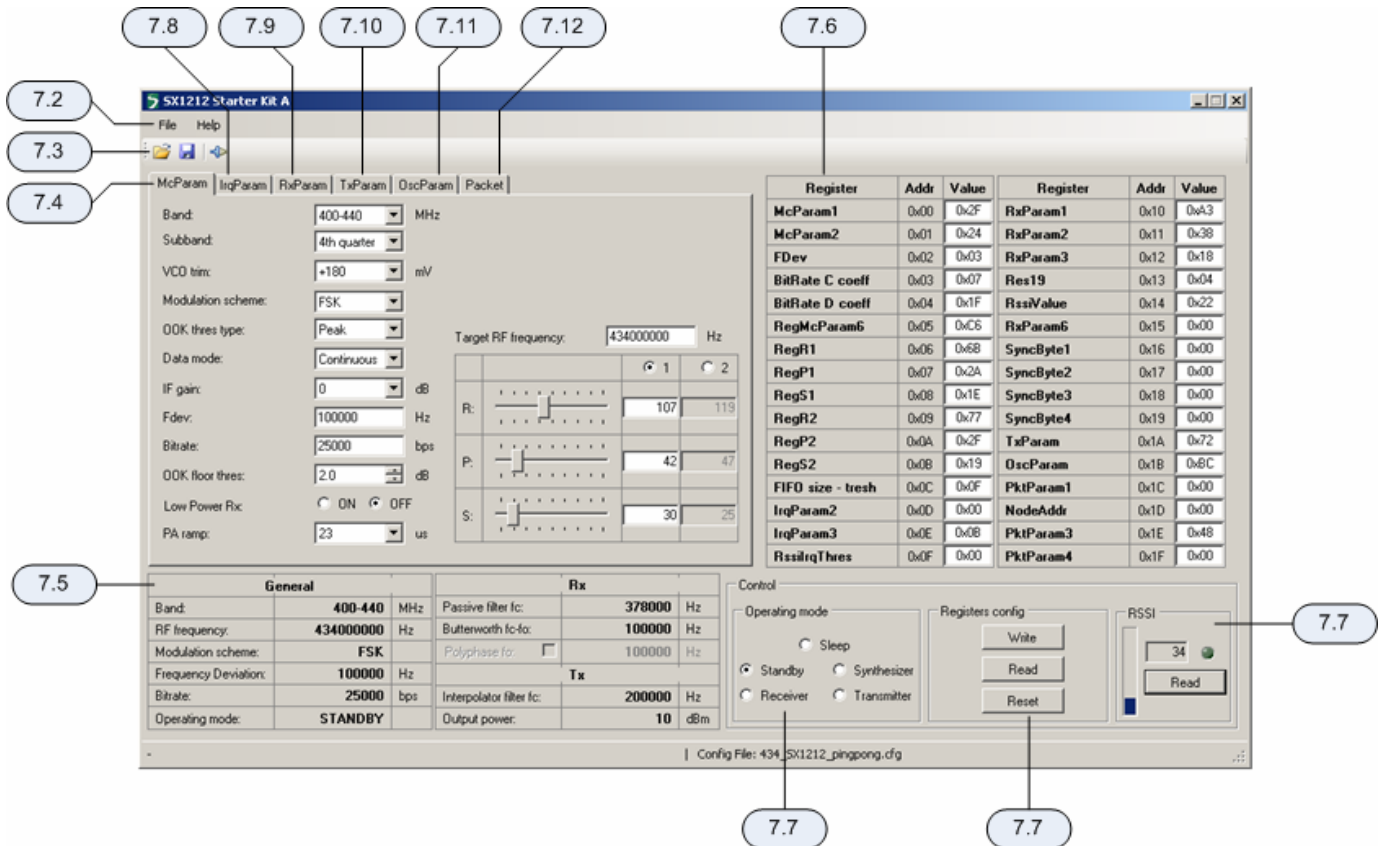
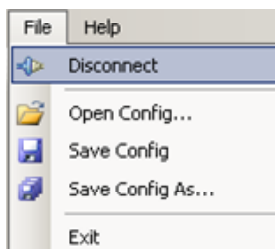

Figure 25. SX1212SKA GUI Overview and References to the User Guide Description of this Chapter

7.2 File Menu



File menu contains some general purpose functions. Some of them can also be accessed on the toolbar by clicking directly on the icon. The first feature in the list provides the possibility of connecting or disconnecting to the USB kit. Care must be taken to ensure that the USB port is closed before removing the USB kit. This functionality may also be accessed through the short cut buttons (see Section 7.3).

The possibility of opening configuration files and saving the present configuration is also provided. This is done through a standard Windows file dialog box.

The Help menu contains two menu items. The first item provides a link to this user guide in PDF format. The second, About SX1212 Starter kit..., gives information in the revision of the software installed.

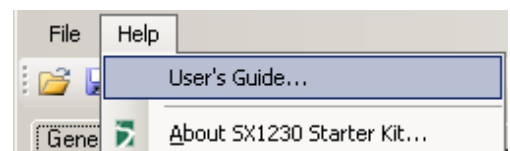

7.3 Shortcut Buttons

The shortcut buttons provide identical functionality to those listed under the file menu



The configuration file open shortcut button. This opens a windows file dialog box to allow access to previously saved SX1212 register configuration files.

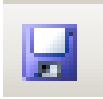

The save configuration file shortcut button immediately saves and overwrites the existing configuration file.



The connect / disconnect button allows the user to manage manually connection and disconnection of the kit. Note that any time the SX1212SKA is to be removed from the system; the kit must first be disconnected.

The saved configuration files are designed to be a useful tool for embedded software development. The file can be opened in any text editor to display the programmed register name, address and hexadecimal value programmed to that address.

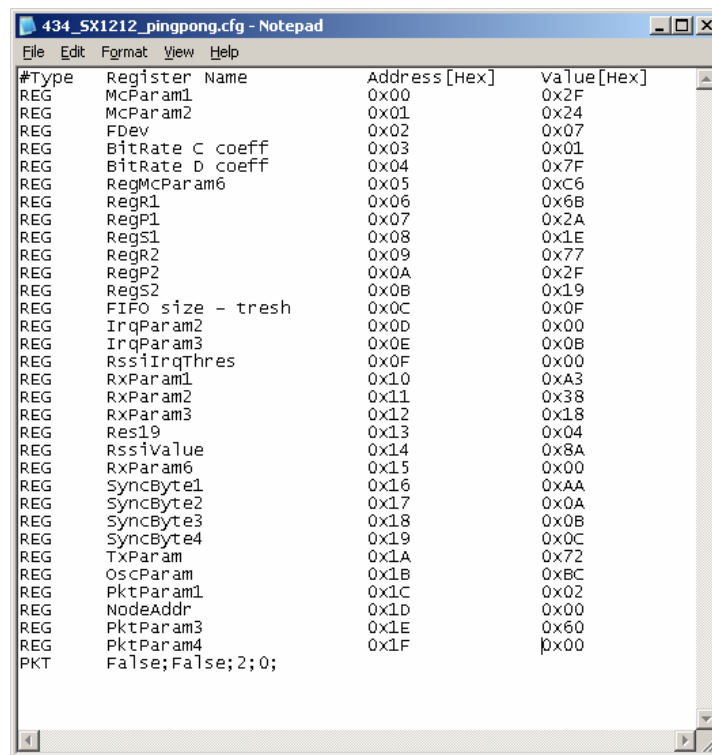

```

#Type Register Name Address [Hex] Value [Hex]
REG McParam1 0x00 0x2F
REG McParam2 0x01 0x24
REG Fdev 0x02 0x07
REG BitRate C coeff 0x03 0x01
REG BitRate D coeff 0x04 0x7F
REG RegMcParam6 0x05 0xC6
REG RegR1 0x06 0x6B
REG RegP1 0x07 0x2A
REG RegS1 0x08 0x1E
REG RegR2 0x09 0x77
REG RegP2 0x0A 0x2F
REG RegS2 0x0B 0x19
REG FIFO size - tresh 0x0C 0x0F
REG IrqParam2 0x0D 0x00
REG IrqParam3 0x0E 0x0B
REG RssiIrqThres 0x0F 0x00
REG RxParam1 0x10 0xA3
REG RxParam2 0x11 0x38
REG RxParam3 0x12 0x18
REG Res19 0x13 0x04
REG RssiValue 0x14 0x8A
REG RxParam6 0x15 0x00
REG SyncByte1 0x16 0xAA
REG SyncByte2 0x17 0x0A
REG SyncByte3 0x18 0x0B
REG SyncByte4 0x19 0x0C
REG TxParam 0x1A 0x72
REG OscParam 0x1B 0xBC
REG PktParam1 0x1C 0x02
REG NodeAddr 0x1D 0x00
REG PktParam3 0x1E 0x60
REG PktParam4 0x1F 0x00
PKT False;False;2;0;
  
```

Figure 26. Example Text Editor Output of the SX1212 Configuration File

7.4 McParam Tab

Band Selection

Band:	400-440	MHz
Subband:	4th quarter	

One of the six operating bands for the SX1212 may be selected here. The SX1212SKA hardware is band specific and so the corresponding band should be selected. Each band is further subdivided into a subband. This should also be selected.

VCO Voltage Trim

VCO trim:	0	mV
-----------	---	----

In some designs the VCO voltage requires trimming. The SX1212SKA reference requires the default offset of 180mV.

Modulation Selection

Modulation scheme:	FSK
--------------------	-----

The SX1212 is capable of FSK and OOK modulation, for a full description please consult the datasheet.

OOK Receiver Detection Type

OOK thres type:	Peak
-----------------	------

Several modes of OOK detection are possible, please see the SX1212 datasheet for mode information on configuring the OOK receiver.

Data Mode

Data mode:	Continuous
------------	------------

Three data modes are available for the SX1212, typically packet mode is selected automatically, requiring no user selection, upon launching the Packet Test (see Section 7.12).

Gain of the IF Stage

IF gain:	0	dB
----------	---	----

The gain of the intermediate frequency amplifier chain can be adjusted manually.

Frequency Deviation

Fdev:	100000	Hz
-------	--------	----

Text entry field for the frequency deviation when using FSK modulation.

Bit Rate

Bitrate:	25000	bps
----------	-------	-----

The bit rate of the transmitted signal (in bps) can be directly edited in this data entry field.

Floor Threshold for OOK Detection

OOK floor thres: dB

Margin to the OOK demodulation threshold – see SX1212 datasheet for more details.

PA Ramping

PA ramp: us

The PA ramp rise time is selectable from the list of programmable values.

Frequency of Operation

Target RF frequency: Hz

		<input checked="" type="radio"/> 1	<input type="radio"/> 2
R:	<input type="text" value="107"/>	<input type="text" value="119"/>	
P:	<input type="text" value="42"/>	<input type="text" value="47"/>	
S:	<input type="text" value="30"/>	<input type="text" value="25"/>	

The frequency of operation of the SX1212 is a set by three frequency divider ratios. (See the illustration below). Based upon the frequency of the crystal oscillator and the values of these divider ratios the local oscillator frequency may be determined.

To simplify this process, the SX1212SKA user interface sees this process completely automated. By entering the desired operating frequency in the text field at the top of the display, the resultant R, P and S divider ratios are calculated (see the SX1212 datasheet for information on their calculation).

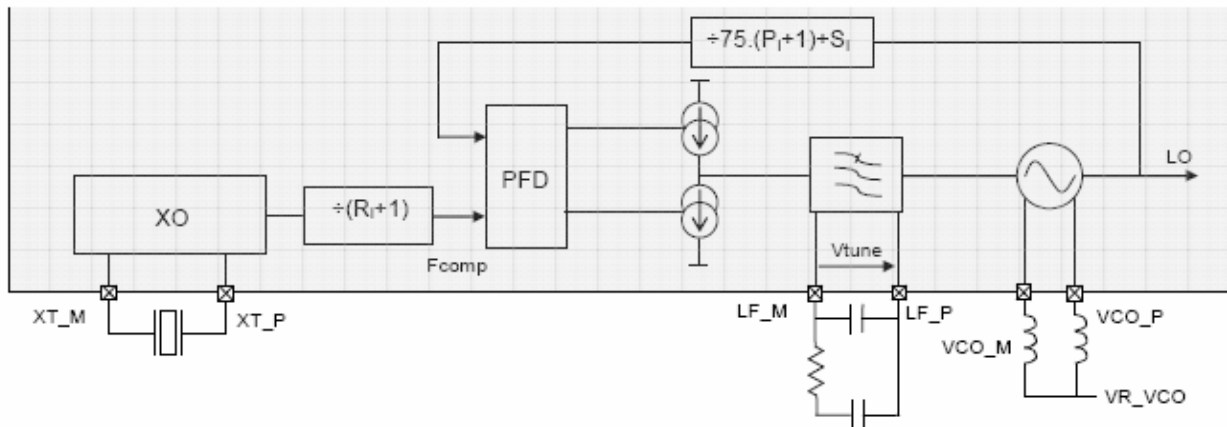

Figure 27. SX1212 Local Oscillator Generation

7.5 Overview Panel

A summary of the values presently entered into the user interface software is shown in the overview display at the bottom of the screen. This is sub-divided into three sections pertaining to: general configuration, transmitter settings and receiver parameters.

General			Rx		
Band:	400-440	MHz	Passive filter fc:	378000	Hz
RF frequency:	434000000	Hz	Butterworth fc-fo:	100000	Hz
Modulation scheme:	FSK		Polyphase fc: <input type="checkbox"/>	100000	Hz
Frequency Deviation:	100000	Hz	Tx		
Bitrate:	25000	bps	Interpolator filter fc:	200000	Hz
Operating mode:	STANDBY		Output power:	10	dBm

Figure 28. The Overview Panel

7.6 Register Hexadecimal Display

Figure 29 shows the register summary of the SX1212. In addition to manual user entry in the fields described in the previous section, direct hexadecimal entries may be made into the register display. Note that values yet to be written to the SX1212 registers appear in red. Note, also, that for full control flexibility, incorrect (red) values entered in the hexadecimal section *will still be written* in the event of a register 'write'. So care must be exercised when editing the hexadecimal values.

Register	Addr	Value	Register	Addr	Value
McParam1	0x00	0x2F	RxParam1	0x10	0xA3
McParam2	0x01	0x24	RxParam2	0x11	0x38
FDev	0x02	0x03	RxParam3	0x12	0x18
BitRate C coeff	0x03	0x07	Res19	0x13	0x04
BitRate D coeff	0x04	0x1F	RssiValue	0x14	0x22
RegMcParam6	0x05	0xC6	RxParam6	0x15	0x00
RegR1	0x06	0x8F	SyncByte1	0x16	0x00
RegP1	0x07	0x38	SyncByte2	0x17	0x00
RegS1	0x08	0x37	SyncByte3	0x18	0x00
RegR2	0x09	0x77	SyncByte4	0x19	0x00
RegP2	0x0A	0x2F	TxParam	0x1A	0x72
RegS2	0x0B	0x19	OscParam	0x1B	0xBC
FIFO size - tresh	0x0C	0x0F	PktParam1	0x1C	0x00
IrqParam2	0x0D	0x00	NodeAddr	0x1D	0x00
IrqParam3	0x0E	0x0B	PktParam3	0x1E	0x48
RssiIrqThres	0x0F	0x00	PktParam4	0x1F	0x00

Figure 29. The Hexadecimal Register Display Summary

7.7 The Mode Control Box

The mode control box is sub-divided into three sections. The first 'Operating mode' allows the user to change the operating mode of the SX1212 by clicking on the radio button corresponding to the desired mode. Note that the transition between modes is instantaneous. The centre section, 'Registers config' allows the register settings entered elsewhere in the user interface to be written to the configuration registers of the SX1212 by clicking the write button. The read operation will read the configuration registers and refresh the user interface display with the values read from the SX1212.

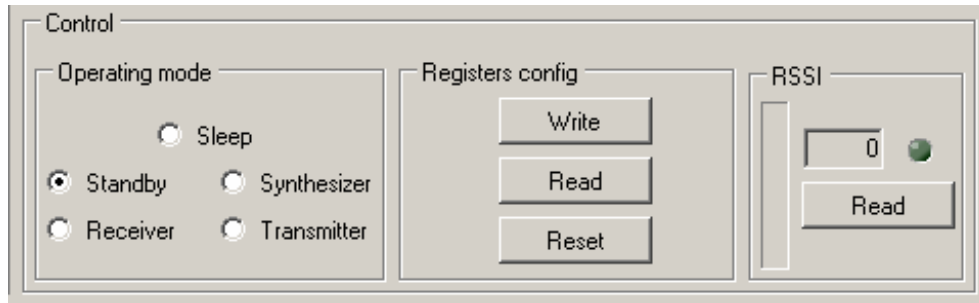

Figure 30. The Mode Control Box also Incorporates RSSI

The third, rightmost, section of the mode control box allows an instantaneous RSSI (received signal strength indicator) measurement. Please note that this feature is only accessible when the SX1212 is in the receiver operating mode.

7.8 The IrqParam Tab

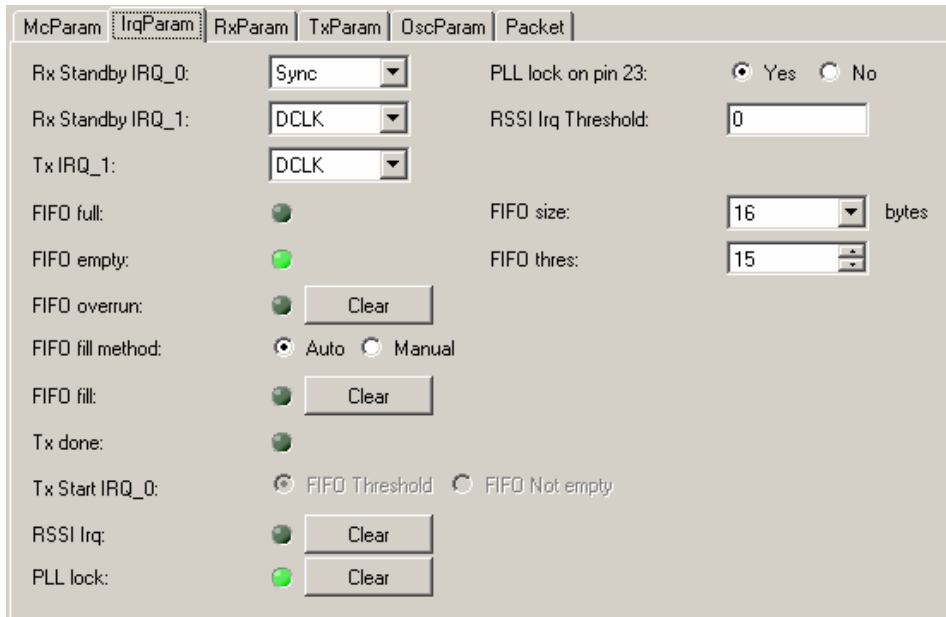

Figure 31. The Interrupt Mapping Display

For total register coverage by the user interface, the interrupt mapping for the SX1212 can be controlled through the configuration of the IrqParam display. Note, however, that the hardware interrupt feature is not used directly by the GUI. For further information please see the corresponding register descriptions in the SX1212 datasheet and the PCB layout and schematics of Section 9.

7.9 The RxParam Tab

The receiver parameter field provides full access to all of the software configurable settings of the SX1212. For reference, a simplified block schematic of the SX1212 receiver is shown in figure Figure 32. The settings configurable in the receiver parameter tab correspond to the programmable baseband receiver functions.

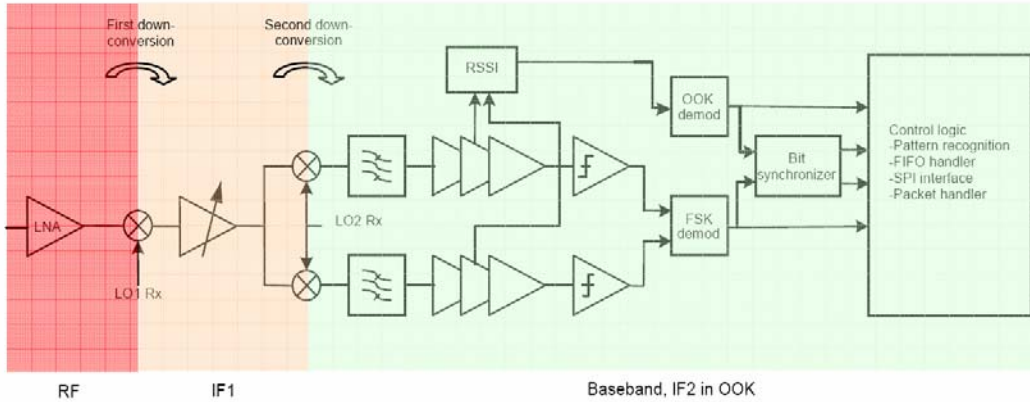

Figure 32. SX1212 Receiver Block Diagram, the Colours Correspond to the Frequency of Operation.

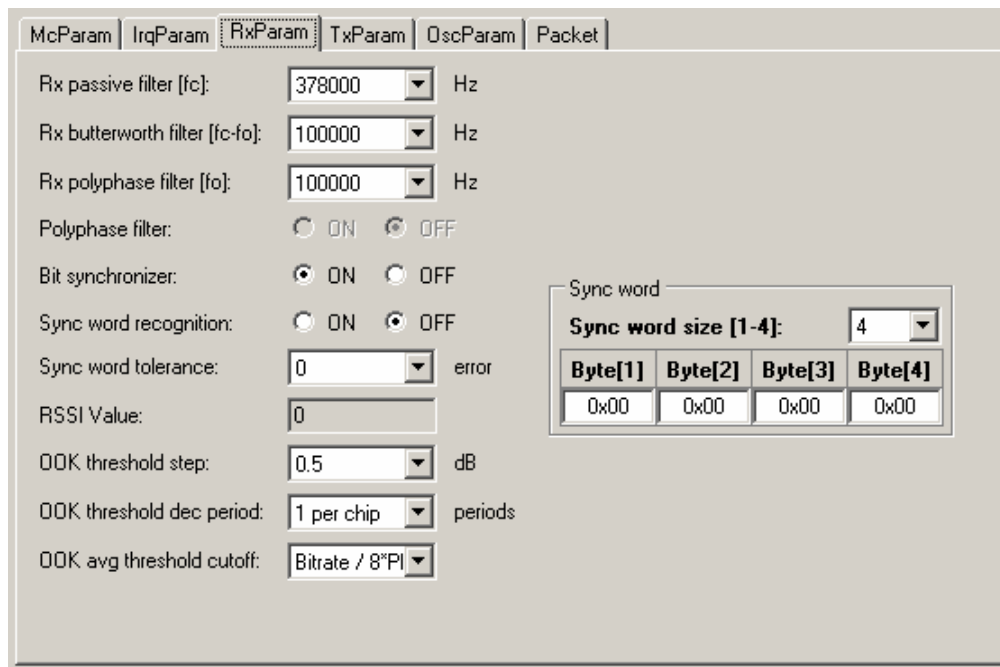

Figure 33. Receiver Parameter Display

For a complete description of the functionality of the receiver section please consult the SX1212 datasheet. However, the principle fields of interest for general use are:

Rx Filters:

The first three text entry fields of the receiver parameters correspond to the baseband filtering section. Note that the Butterworth filter is the narrowest of the three filters and determines the receiver channel bandwidth.

Bit Synchroniser:

This block performs timing recovery and synchronises the decision on whether a given bit is logical high or low based upon the received bit stream. This block yields a substantial improvement in receiver sensitivity performance and it is hence recommended that it be left enabled.

Sync Word:

The synchronisation word is applicable to operation in buffered and packet modes. For packet mode operation the sync word is set using the packet editor – this may be found in the 'Packet' Tab (Section 7.12). Link testing by the SX1212SKA is done in packet mode only – sync word provision is made here for completeness.

OOK Settings:

OOK demodulation is based upon measurements from the RSSI block and there are a rich variety of settings for how the OOK signal is detected and processed. These techniques and the corresponding settings are given a detailed treatment in the SX1212 datasheet.

7.10 The TxParam Tab

The transmitter configuration of the SX1212 is shown in Figure 34. This shows that the modulating signal is generated by direct digital synthesis (DDS), unconverted through the superheterodyne mixer stages and then amplified by a power amplifier chain.

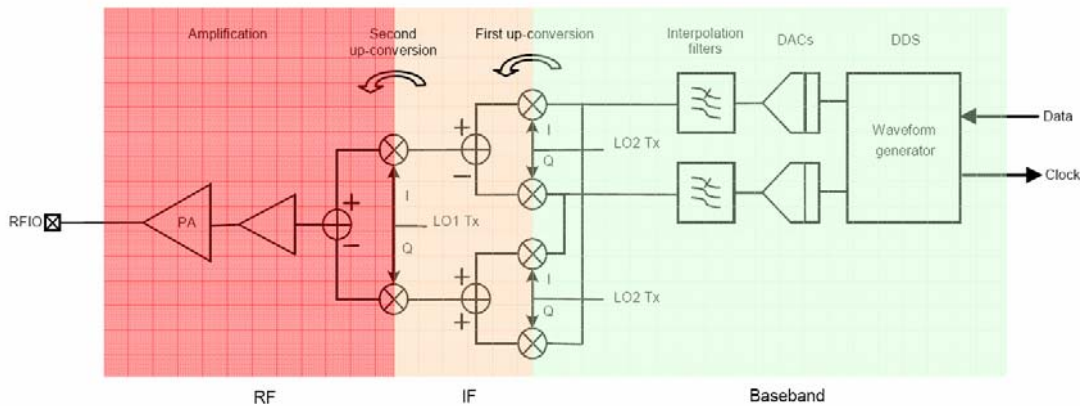

Figure 34. SX1212 Simplified Transmitter Block Schematic Diagram

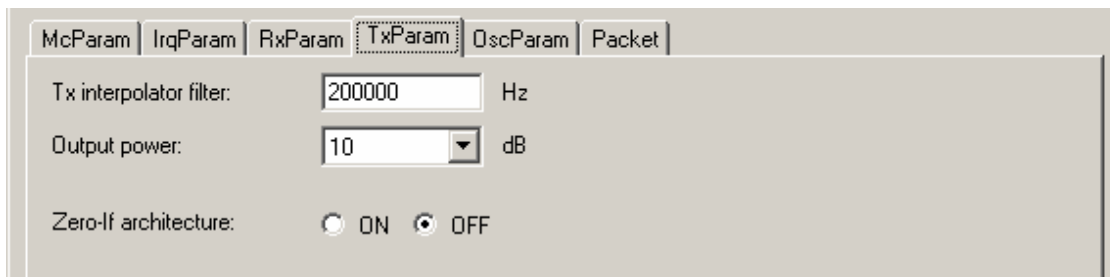

Figure 35. The Transmitter Parameter Tab Display

The three parameters which are configurable for transmit operation of the SX1212 are:

Output Power:

The output power of the SX1212 can be programmed in 3 dB steps. Valid programmable powers are selected from a drop-down list of valid values.

Interpolation Filter Setting:

The DDS output requires filtering to remove the spuri common in the generation of signals through this technique; this is performed by the interpolation filters. The cut-off frequency of the interpolation filters can be selected from the drop down menu of valid values. The technique for calculating the cut-off frequency may be found in the SX1212 datasheet.

Zero IF Architecture Enable:

Configures the SX1212 for direct conversion transmitter operation. For a full description and the ramifications for the R, P and S divider settings please consult the SX1212 datasheet.

7.11 The OscParam Tab

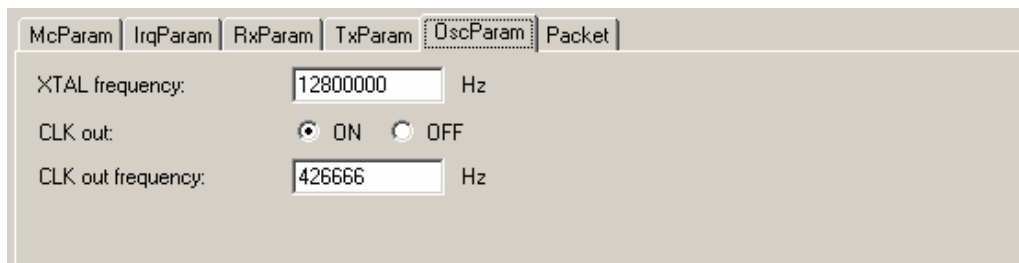

Figure 36. The Oscillator Parameter Display

The oscillator parameter display gives access to the clock output functionality. This can be enabled or disabled and the frequency changed by entering a value in the 'CLK out frequency' text field. Note also that there is provision to change the frequency of the crystal. Changing of the crystal frequency has a knock on effect on all parameters that are a function of the reference frequency, for example bit rate, filter settings, RF output frequency. The SX1212SKA is fitted with the 12.8 MHz crystal recommended in the SX1212 reference design. For this reason the crystal value should, typically, be left unchanged.

7.12 The Packet Test Tab

The 'Packet' tab is the principle interface for conducting transmission or reception testing. The display, as shown in Figure 35 is divided into three horizontal portions. The top portion of the display is given to the packet editor. Here the configuration of the packet, either to be transmitted or received by the SX1212SKA is constructed.

The packet layout contains all of the features described in the SX1212 datasheet. This includes:

Preamble

This input allows the user enable and set the length of a pulse train preamble (sent at the data rate).

Sync word size

A custom synchronisation word of up to 4 bytes may also be added.

Sync tol

The number of errors which may be accommodated in the sync word (bits), before the packet is rejected.

Format / Length / Address

Fixed or variable length packets may also be stipulated (see the SX1212 datasheet for more information), as may an optional 1 byte address.

Digital Coding

Optional channel coding including CRC, data whitening and Manchester coding are also available.

With these options entered the constructed packet is shown in the 'Packet' frame. Where the SX1212SKA is to be used in transmit mode, the packet payload may also be edited in either ASCII or hexadecimal. Packet transmission is enabled by selecting the 'Transmission' radio button. This starts when the 'Start' button is pressed. Either infinite transmission (repeat value = 0) or a finite number of packets may be transmitted by editing the repeat value.

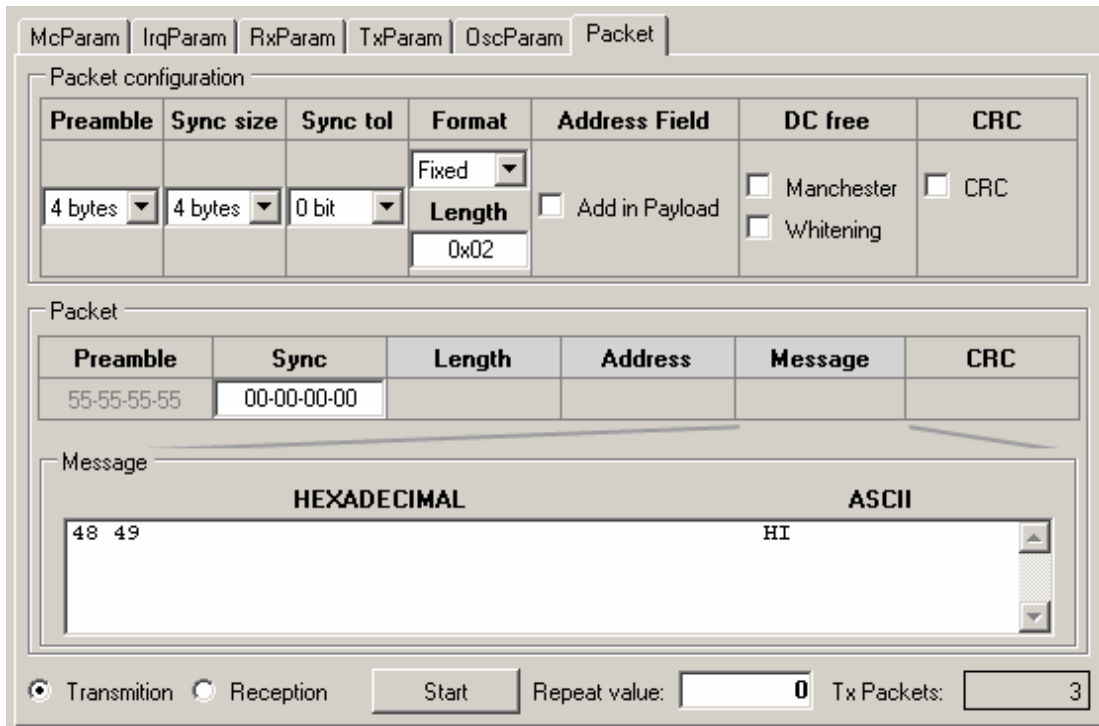
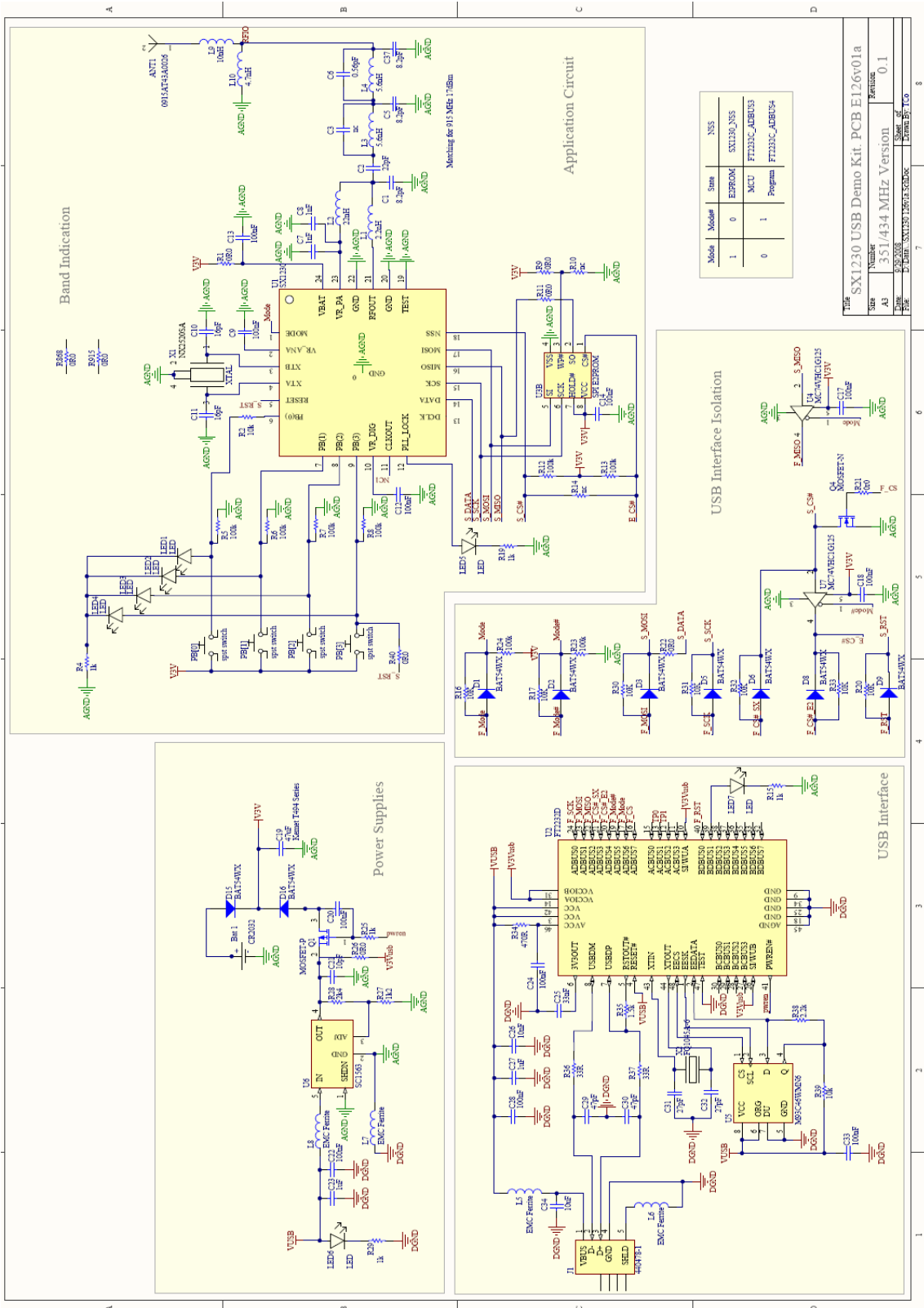
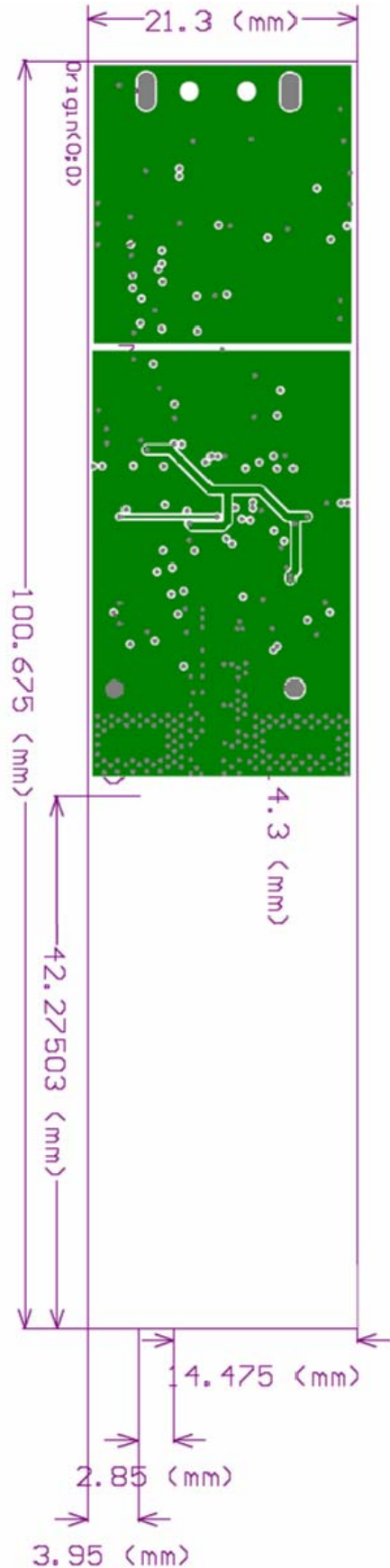
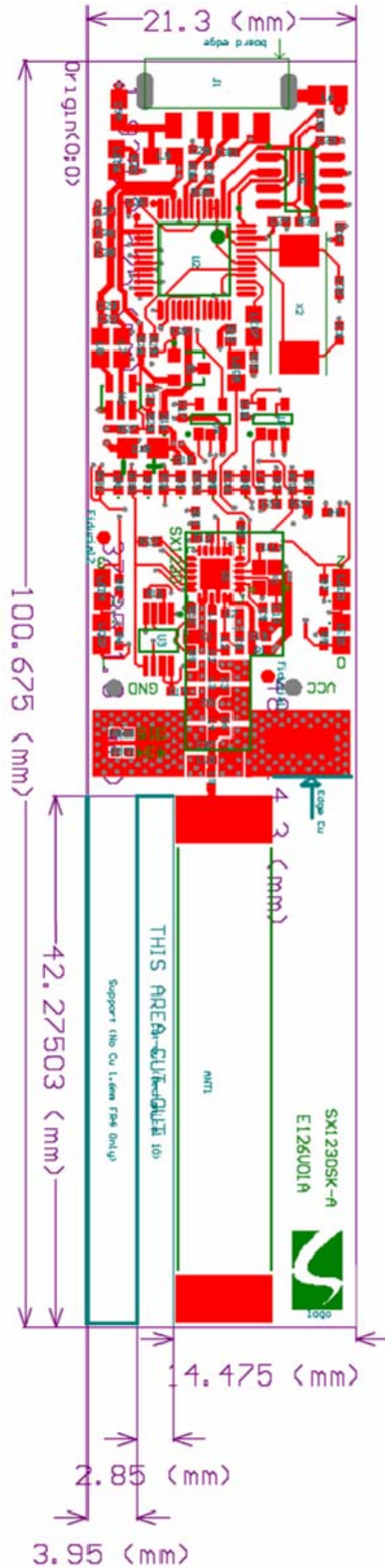

Figure 37. The Packet Receiver / Transmitter Test Display

For receive mode, the normal mode of operation in conjunction with the SX1230SKA, the reception the 'Reception' radio button is selected and the start button pressed. From this moment the SX1212 is placed in receive mode and listens continuously for a packet corresponding to the format entered in the packet editor. Upon successful reception, the payload received is shown in the 'Message Box' and the number of received packets is incremented. For indication of the signal strength received by the SX1212SKA, the RSSI display (see Section 7.7) is activated and continuously refreshed.

8 Schematics and 4-Layer PCB Layout: SX1230SKA





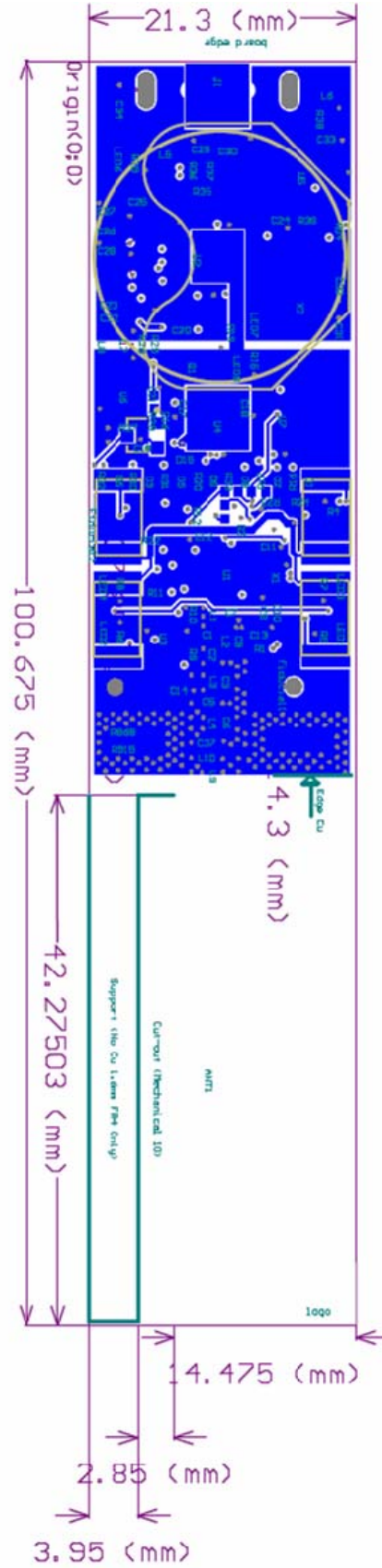
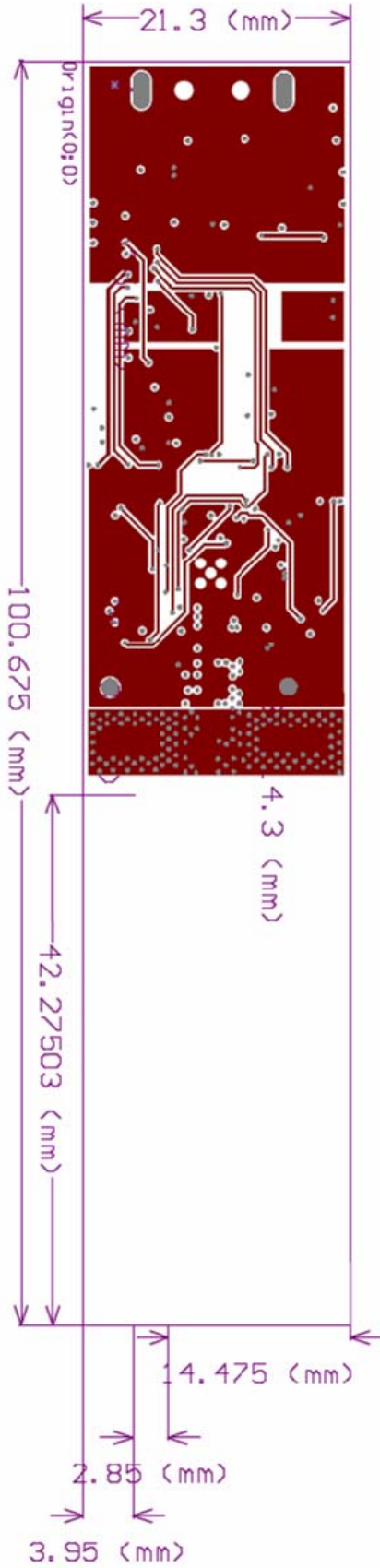

9 Schematics and 2-Layer PCB Layout: SX1211/12SKA

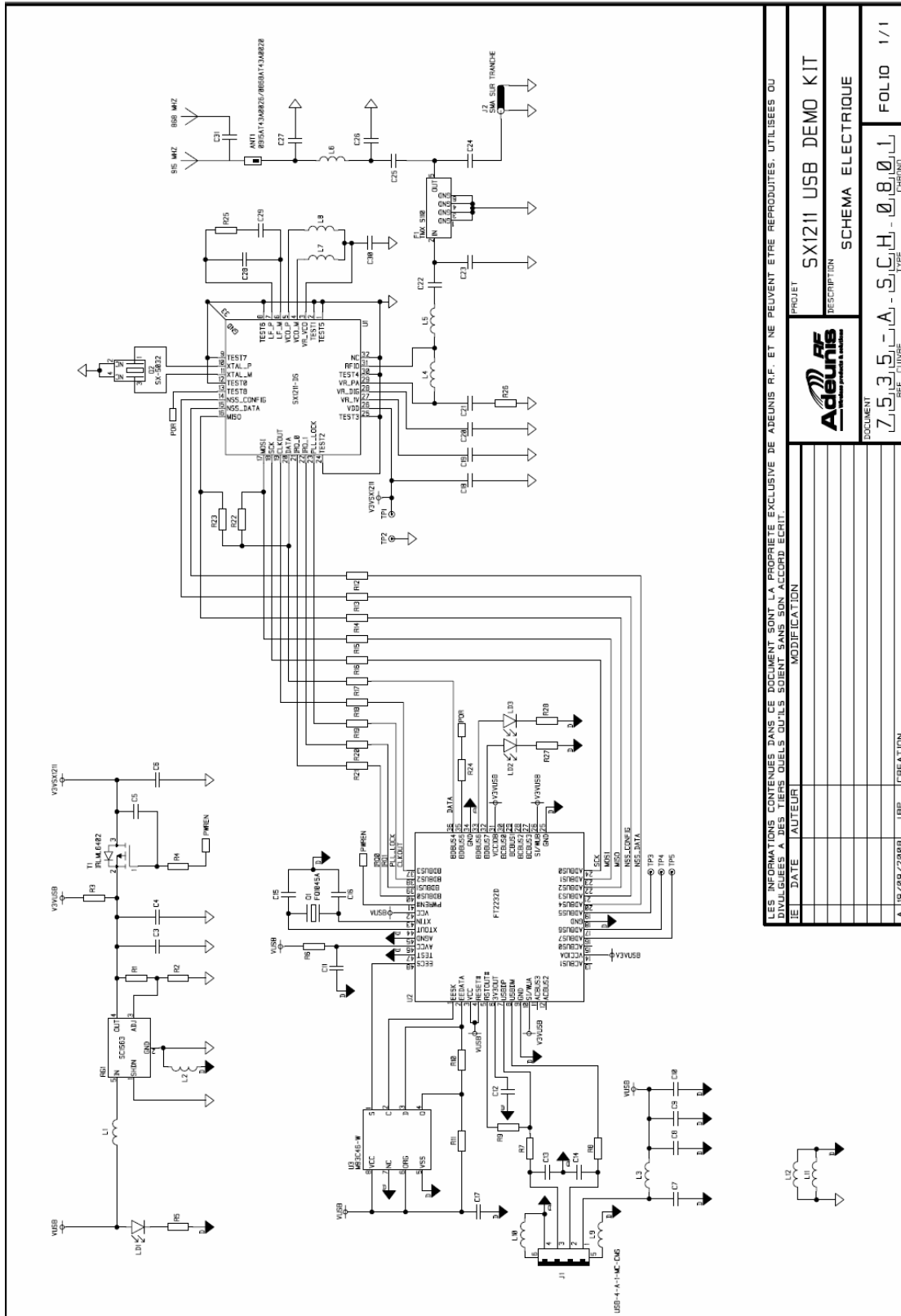

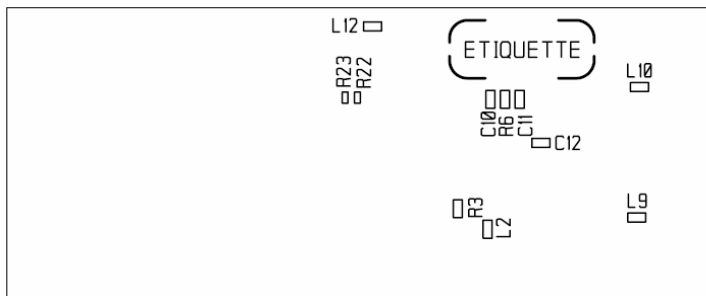
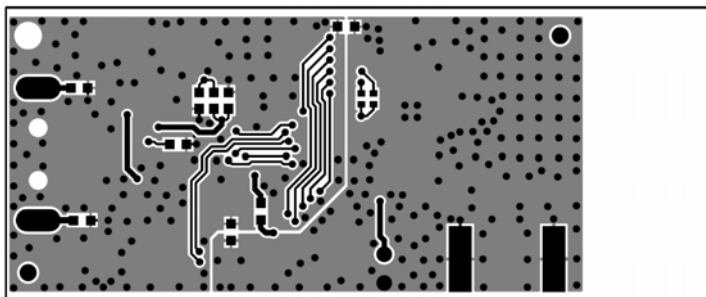
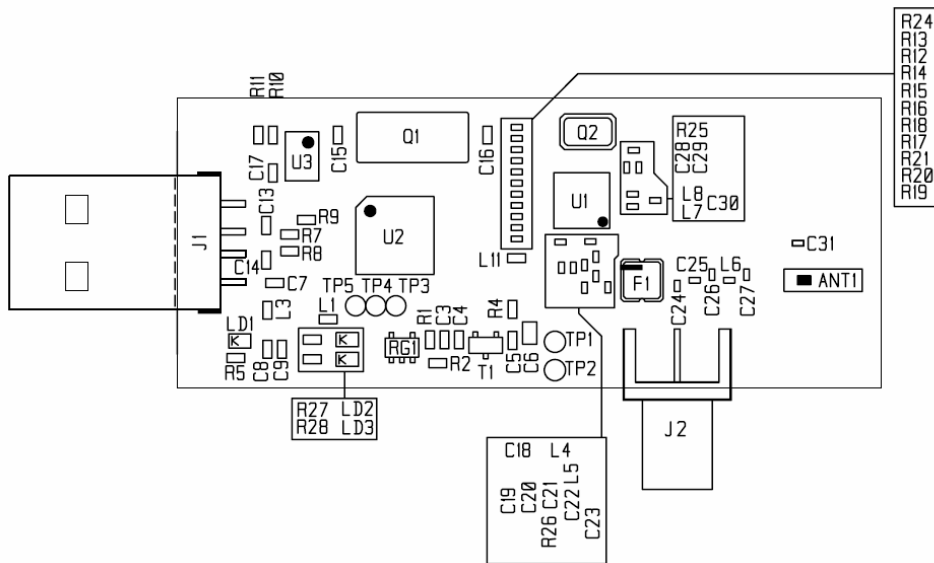
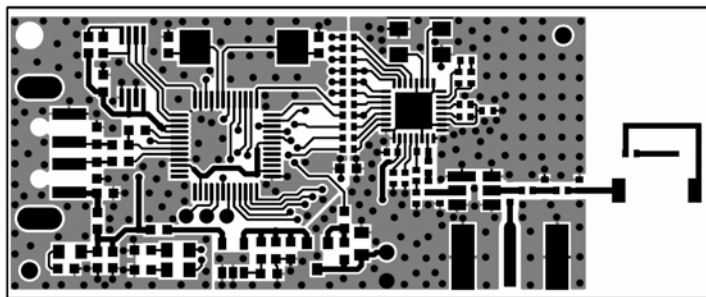

10 References

- [1] SX1230 Datasheet
- [2] SX1212 Datasheet

© Semtech 2008

All rights reserved. Reproduction in whole or in part is prohibited without the prior written consent of the copyright owner. The information presented in this document does not form part of any quotation or contract, is believed to be accurate and reliable and may be changed without notice. No liability will be accepted by the publisher for any consequence of its use. Publication thereof does not convey nor imply any license under patent or other industrial or intellectual property rights. Semtech assumes no responsibility or liability whatsoever for any failure or unexpected operation resulting from misuse, neglect improper installation, repair or improper handling or unusual physical or electrical stress including, but not limited to, exposure to parameters beyond the specified maximum ratings or operation outside the specified range.

SEMTECH PRODUCTS ARE NOT DESIGNED, INTENDED, AUTHORIZED OR WARRANTED TO BE SUITABLE FOR USE IN LIFE-SUPPORT APPLICATIONS, DEVICES OR SYSTEMS OR OTHER CRITICAL APPLICATIONS. INCLUSION OF SEMTECH PRODUCTS IN SUCH APPLICATIONS IS UNDERSTOOD TO BE UNDERTAKEN SOLELY AT THE CUSTOMER'S OWN RISK. Should a customer purchase or use Semtech products for any such unauthorized application, the customer shall indemnify and hold Semtech and its officers, employees, subsidiaries, affiliates, and distributors harmless against all claims, costs damages and attorney fees which could arise.

Contact Information

Semtech Corporation
Advanced Communications and Sensing Products Division
200 Flynn Road, Camarillo, CA 93012
Phone: (805) 498-2111 Fax: (805) 498-3804

Mouser Electronics

Authorized Distributor

Click to View Pricing, Inventory, Delivery & Lifecycle Information:

[Semtech:](#)

[SX1212SKA433](#) [SX1212-12SKA433](#)