

PhlatLight[®] LED Illumination Products

SST-90 Series

Features

- Extremely high optical output: Over 500 Red Lumens
Over 950 Green lumens
Over 200 Blue Lumens
- High thermal conductivity package - junction to case thermal resistance of only 0.64 °C/W
- Large, monolithic chip with surface emitting area of 9 mm²
- High luminous efficacy
- Lumen maintenance of greater than 70% after 60,000 hours
- Environmentally friendly: RoHS compliant
- Variable drive currents: less than 1 A through 6 A
- Currently available in Red, Green and Blue
- Electrically isolated thermal path

Applications

- Entertainment Lighting
- Architectural Lighting
- Residential Lighting
- Medical Lighting
- Spot Lighting
- Emergency Vehicle Lighting
- Displays and Signage
- General Illumination

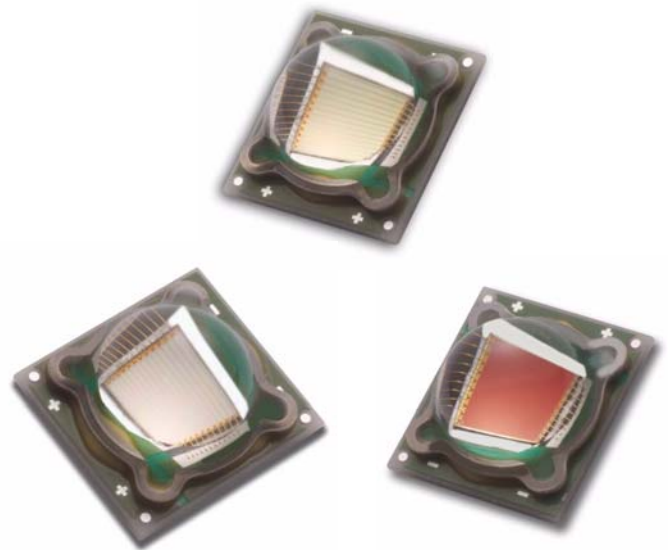

PhlatLight[®] LEDs enable a new class of illumination applications.

Table of Contents

Technology Overview.....	2
Test Specifications.....	2
PhlatLight Bin Codes.....	3
Product Shipping and Labeling Information.....	4
Optical and Electrical Characteristics	5
Flux and Spectral Characteristics vs. Temperature	9
Lifetime and Lumen Maintenance	9
Spectral Characteristics.....	9
Radiation Patterns	10
Thermal Resistance	10
Mechanical Dimensions - Emitter	11
Mechanical Dimensions - Star	12
Solder Profile	13
Ordering Information	14

Technology Overview

PhlatLight LEDs benefit from a suite of innovations in the fields of chip technology, packaging, and thermal management. These breakthroughs allow illumination designers to achieve efficient light engine designs and deliver high brightness solutions.

PhlatLight Technology

The name PhlatLight is derived from Photonic Lattice. Photonic lattice technology creates true surface emission from the source, which enables large area LED chips with uniform brightness over the entire LED chip surface. The optical power and brightness produced by these large monolithic chips enable solutions which replace arc and halogen lamps where arrays of traditional high power LEDs cannot.

Packaging Technology

Thermal management is critical in high power LED applications. With a thermal resistance from junction to case of 0.64 °C/W, PhlatLight SST-90 devices have the lowest thermal resistance of any LED on the market. This allows the LED to be driven at higher current densities while maintaining a low junction temperature, thereby resulting in brighter and longer lifetimes. The package is easy to use, and ready to be mounted in the lighting system.

Reliability

Designed from the ground up, PhlatLight LEDs are one of the most reliable light sources in the world today. PhlatLight LEDs have passed a rigorous suite of environmental and mechanical stress tests, including mechanical shock, vibration, temperature cycling and humidity, and have been fully qualified for use in extreme high power and high current applications. With very low failure rates and median lifetimes that are well above 60,000 hours, PhlatLight LEDs are ready for the most demanding applications.

Environmental Benefits

PhlatLight LEDs help reduce power consumption and the amount of hazardous waste entering the environment. All PhlatLight products manufactured by Luminus are RoHS compliant and free of hazardous materials, including lead and mercury.

Understanding PhlatLight Test Specifications

Every PhlatLight LED device is fully tested to ensure that it meets the high quality standards of Luminus' products.

Multiple Operating Points (3.15 A, 6.3 A)

The tables on the following pages provide typical optical and electrical characteristics. Since the LEDs can be operated over a wide range of drive conditions (currents from <1.0 A to 6.3 A, and duty cycle from <1% to 100%) multiple drive conditions are listed.

PhlatLight SST-90 devices are production specified at 3.15 A. The values shown at 3.15 A and 6.3 A are for additional reference at other possible drive conditions.

PhlatLight SST-90 Bins

PhlatLight LEDs are specified for luminous flux and wavelength at a drive current of 3.15 A (0.35 A/mm²) and placed into one of the following luminous flux (FF) and wavelength (WW) bins:

Blue Bins

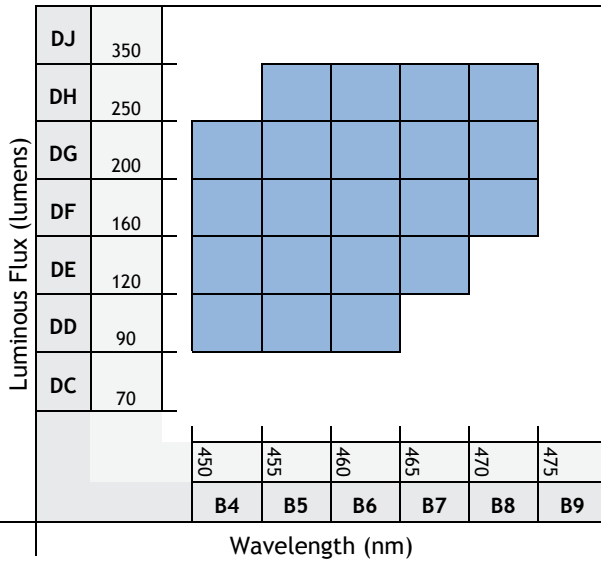

Green Bins

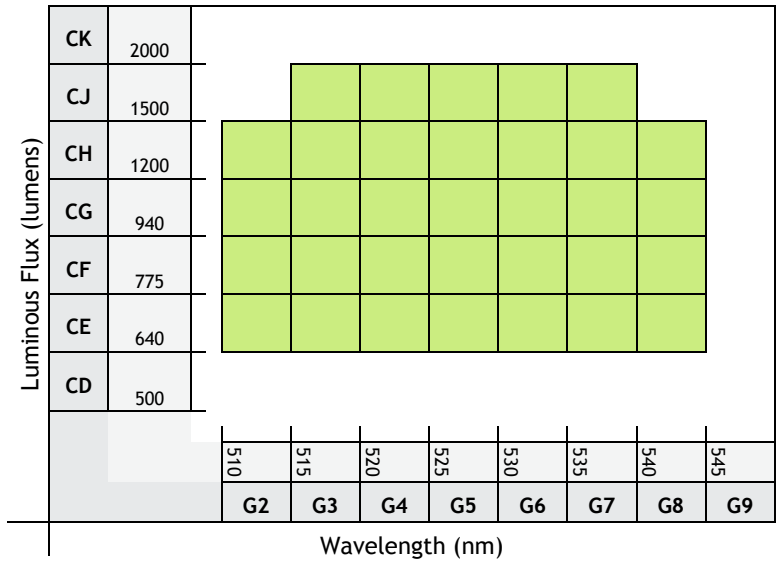

Red Bins

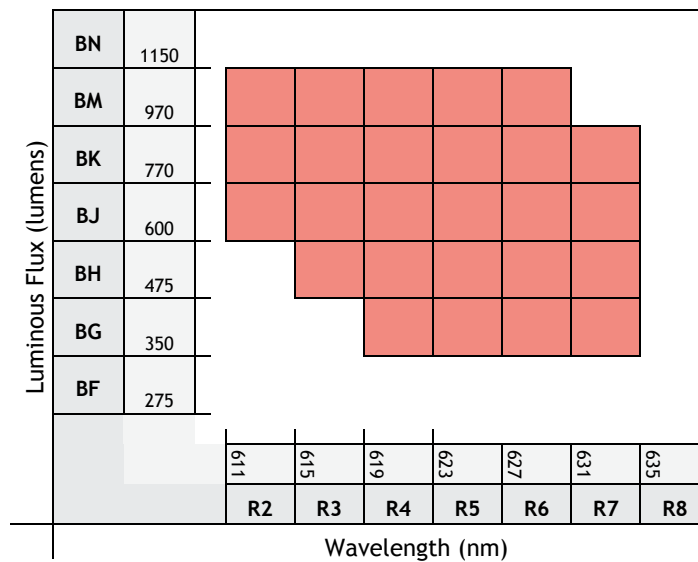

PhlatLight Product Shipping and Labeling Information

All PhlatLight products are packaged and labeled with their respective bin as outlined in the tables on page 3. When shipped, each package only containing one bin. The part number designation is as follows:

SST — 90 — X — F11 — FF — WW

Product Family	Chip Area	Color	Package Configuration	Flux Bin	Wavelength Bin
SST: Surface Mount	90: 9.0 mm ²	R: Red	F11: 10mm x 11 mm emitter	See page 3 for bins	See page 3 for bins
		G: Green			
		B: Blue			

Example: The part number SST-90-R-F11-BK-R4 refers to a red, surface mount part, a 9mm² die, with a flux range of 770-970 lumens and a wavelength range of 619 nm to 623 nm.

Note: Some flux and wavelength bins may have limited availability. Application specific bin kits, consisting of multiple bins, may be available. For ordering information, please refer to page 13 or contact your local Luminus sales representative.

Optical and Electrical Characteristics¹

Red				
Drive Condition ²		3.15 A Continuous	6.3 A Continuous	
Parameter	Symbol	Typical Values at Test Current ³	Values at Indicated Current	Unit
Current Density	j	0.35	0.70	A/mm ²
Forward Voltage	V _{F min}	TBD		V
	V _{F typ}	2.0	2.2	V
	V _{F max}	TBD		V
Luminous Flux ⁴	Φ _{V typ}	500	800	lm
Dominant Wavelength	λ _d	622	624	nm
FWHM	Δλ _{1/2}	16	18	nm
Chromaticity Coordinates ^{5,6}	x	0.697	0.700	-
	y	0.303	0.300	-

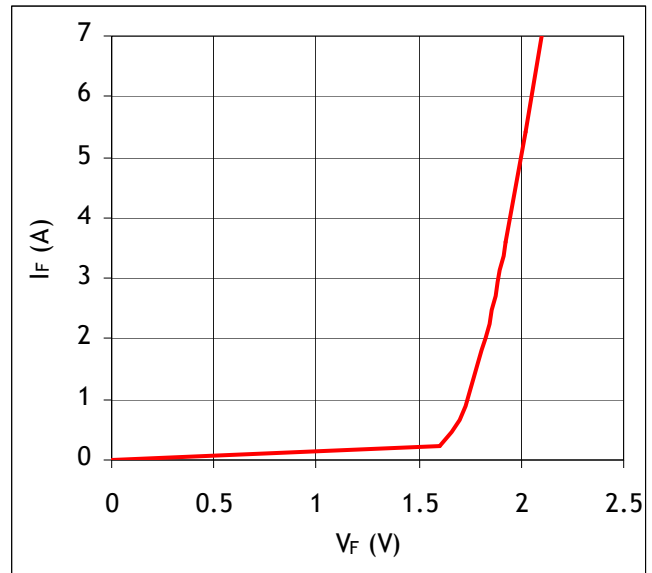
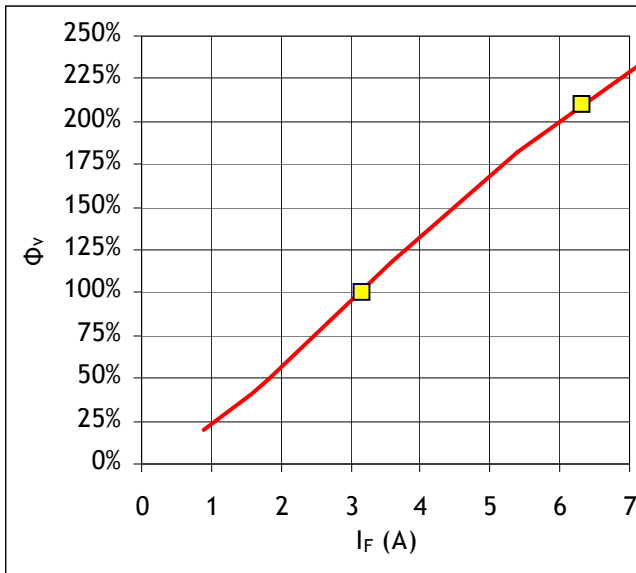

Yellow squares indicate reference drive conditions

Optical and Electrical Characteristics¹

Green				
Drive Condition ²		3.15 A Continuous	6.3 A Continuous	
Parameter	Symbol	Typical Values at Test Current ³	Values at Indicated Current	Unit
Current Density	j	0.35	0.70	A/mm ²
Forward Voltage	V _{F min}	TBD		V
	V _{F typ}	3.4	3.7	V
	V _{F max}	TBD		V
Luminous Flux ⁴	Φ _{V typ}	950	1650	lm
Dominant Wavelength	λ _d	537	533	nm
FWHM	Δλ _{1/2}	35	38	nm
Chromaticity Coordinates ^{5,6}	x	0.223	0.204	-
	y	0.720	0.716	-

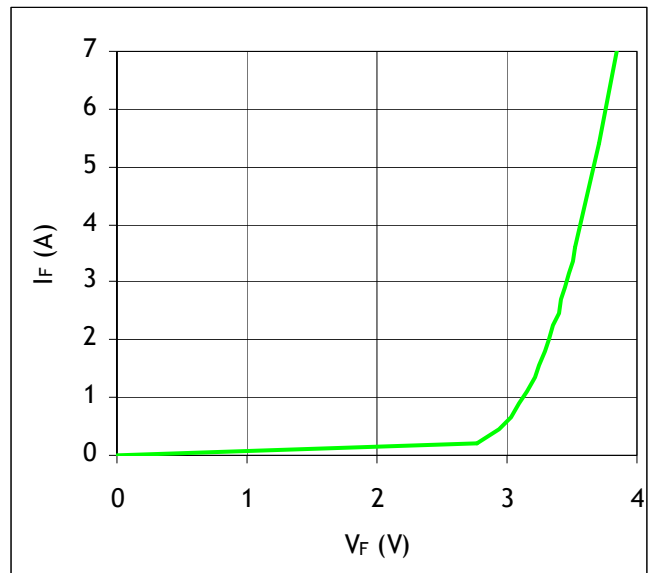
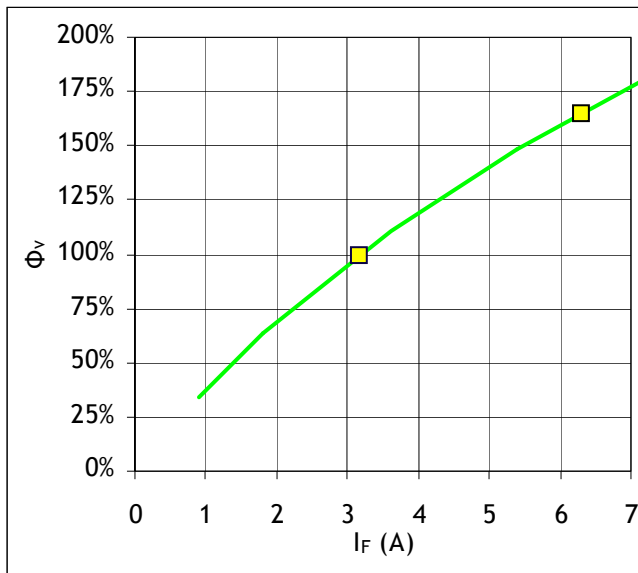

Yellow squares indicate reference drive conditions

Optical and Electrical Characteristics¹

Blue				
Drive Condition ²		3.15 A Continuous	6.3 A Continuous	
Parameter	Symbol	Typical Values at Test Current ³	Values at Indicated Current	Unit
Current Density	j	0.35	0.70	A/mm ²
Forward Voltage	V _{F min}	TBD		V
	V _{F typ}	3.4	3.6	V
	V _{F max}	TBD		V
Luminous Flux ⁴	Φ _{V typ}	200	350	lm
Dominant Wavelength	λ _d	465	464	nm
FWHM	Δλ _{1/2}	21	24	nm
Chromaticity Coordinates ^{5,6}	x	0.139	0.142	-
	y	0.047	0.043	-

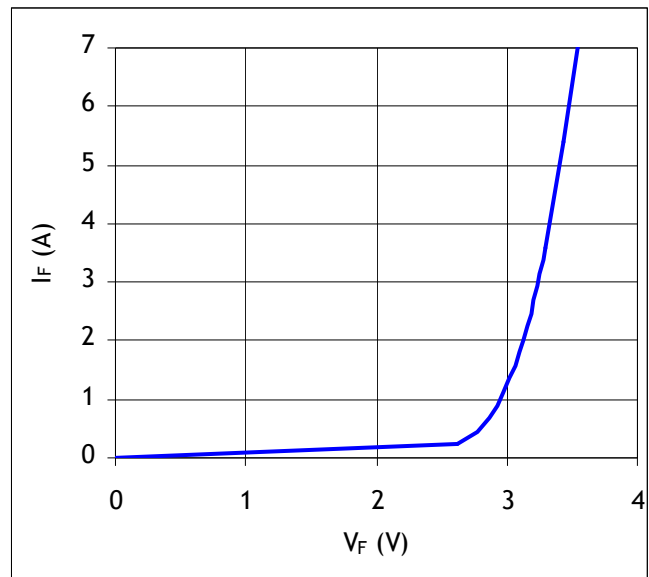
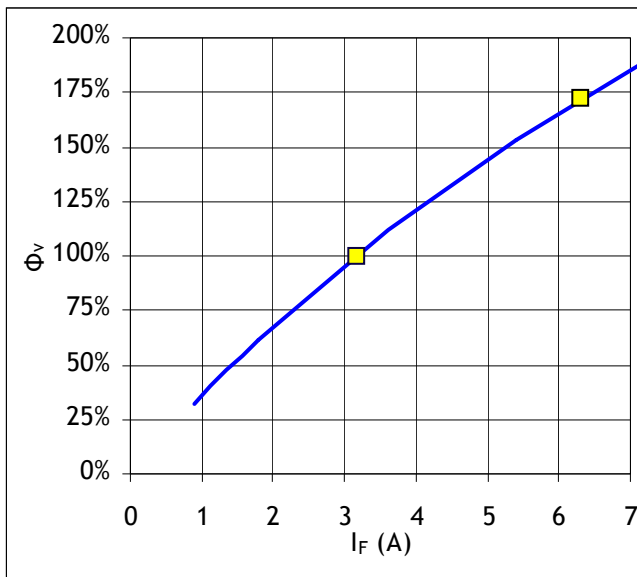

Yellow squares indicate reference drive conditions

Optical and Electrical Characteristics¹

Common Characteristics

	Symbol	Red	Green	Blue	Unit
Emitting Area		9.0	9.0	9.0	mm ²
Emitting Area Dimensions		3 x 3	3 x 3	3 x 3	mmxmm
Dynamic Resistance	Ω_{dyn}	0.03	0.04	0.07	Ω
Thermal Coefficient of Photometric Flux		-0.96	-0.18	-0.007	%/°C
Thermal Coefficient of Radiometric Flux		-0.52	-0.20	-0.17	%/°C
Thermal Coefficient of Junction Voltage		-1.3	-4.6	-3.5	mV/°C

Absolute Maximum Ratings

	Symbol	Red	Green	Blue	Unit
Maximum Current ⁷		6.3	9	9	A
Maximum Junction Temperature ⁸	T_{jmax}	125	150	150	°C
Storage Temperature Range		-40/+100	-40/+100	-40/+100	°C

Note 1: All ratings are based on test conditions of $T_{\text{j}}=25\text{C}$, 20 millisecond pulse. See Thermal Resistance section for T_{j} definition.

Note 2: Listed drive conditions are typical for common applications. PhlatLight SST-90 red, green and blue devices can be driven at currents ranging from <1 A to 6.3 A and at duty cycles ranging from 1% to 100%. Drive current and duty cycle should be adjusted as necessary to maintain the junction temperature desired to meet application lifetime requirements.

Note 3: Unless otherwise noted, values listed are typical. Devices are production tested and specified at 0.35 A/mm². Other values are for reference only.

Note 4: Total flux from emitting area at listed dominant wavelength. Reported performance is included to show trends for a selected power level. For specific minimum and maximum values, use bin tables. For product roadmap and future performance of devices, contact Luminus.

Note 5: In CIE 1931 chromaticity diagram coordinates, normalized to $X+Y+Z=1$.

Note 6: For reference only.

Note 7: Luminus PhlatLight LEDs are designed for operation to an absolute maximum current as specified above. Product lifetime data is specified at recommended forward drive currents. Sustained operation at or beyond absolute maximum currents will result in a reduction of device lifetime compared to recommended forward drive currents. Actual device lifetimes will also depend on junction temperature. Refer to the lifetime derating curves for further information. In pulsed operation, rise time from 10-90% of forward current should be larger than 0.5 microseconds.

Note 8: Lifetime dependent on LED junction temperature. Input power and thermal system must be properly managed to ensure lifetime. See charts on pg 11 for further information.

Note 9: Special design considerations must be observed for operation under 1 A. Please contact Luminus for further information.

Note 10: Caution must be taken not to stare at the light emitted from these LEDs. Under special circumstances, the high intensity could damage the eye.

Light Output and Spectral Characteristics Over Heat Sink Temperature

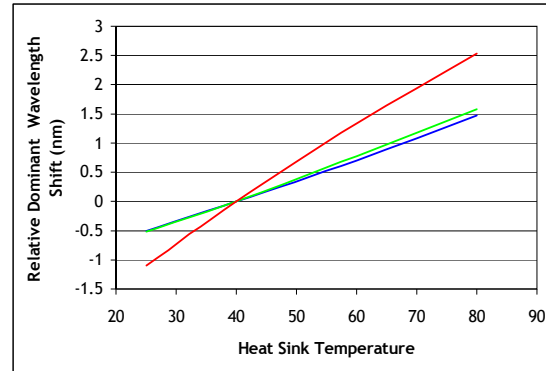
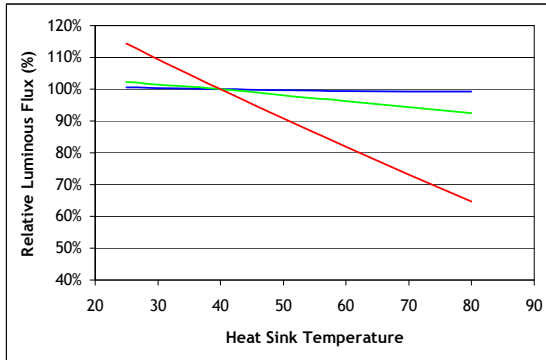

Median Lifetime Estimate vs. T_j^{13}

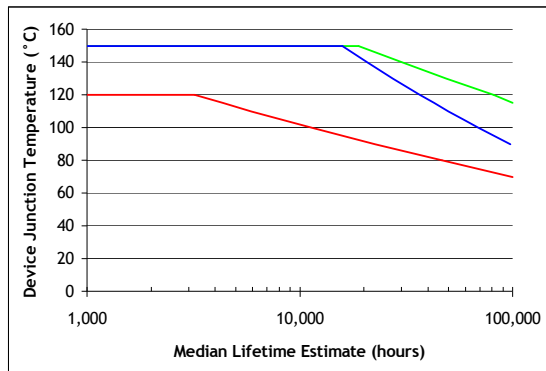

Lumen Maintenance¹⁴

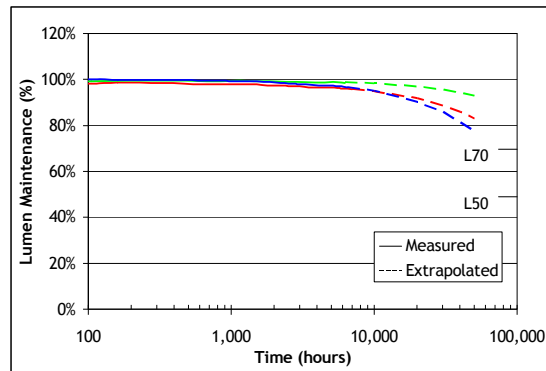

Typical Spectrum¹⁵

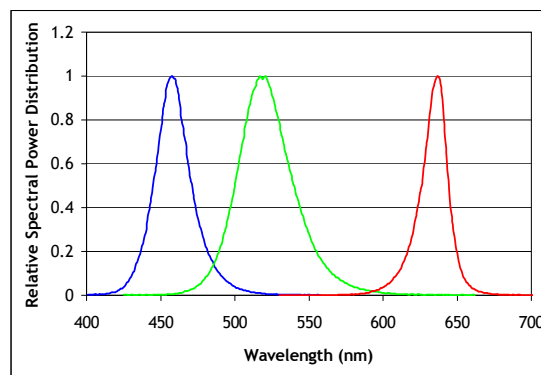

Note 13. Median lifetime estimate as a function of junction temperature at 0.35 A/mm² in continuous operation. Lifetime defined as time to 70% of initial intensity. Based on preliminary lifetime test data. Data can be used to model failure rate over typical product lifetime.

Note 14. Lumen maintenance vs. time at 0.35 A/mm² in continuous operation, Red junction temperature of 70°C, Green junction temperatures of 120°C, Blue junction temperatures of 100°C.

Note 15. Typical spectrum at current density of 0.35 A/mm² in continuous operation.

Typical Radiation Pattern

Typical Polar Radiation Pattern for Blue and Green

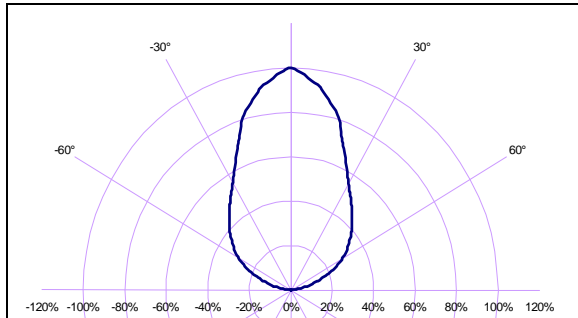

Typical Polar Radiation Pattern for Red

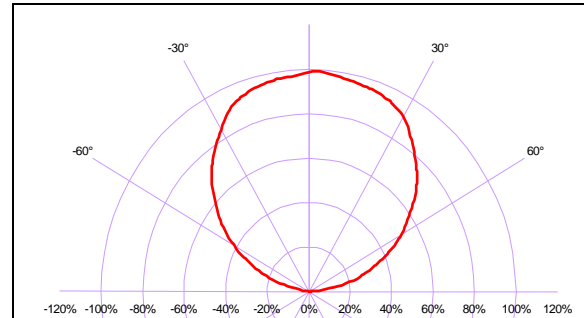

Thermal Resistance

The diagram shows a cross-section of the LED assembly. From top to bottom, the layers are: Dome, Die Junction, Window Frame, Ceramic Substrate, and Aluminum core-board. Below the core-board is a Heat sink. Thermal nodes are indicated by red dots: T_j at the die junction, T_c at the ceramic substrate, T_b at the aluminum core-board, and T_{hs} at the heat sink. A dashed red line indicates the T_{hs} definition as 3 mm from the core-board.

Typical Thermal Resistance

R_{j-c}^1	0.64 °C/W
R_{j-b}^1	2.02 °C/W
R_{j-hs}^2	2.15 °C/W

Note 1: Thermal resistance values are based on FEA model results correlated to measured R_{j-hs} data.

Note 2: Thermal resistance is measured using a SAC305 solder, an Al-clad MCPCB, and eGraf 1205 thermal interface material.

Mechanical Dimensions - SST-90 Emitter

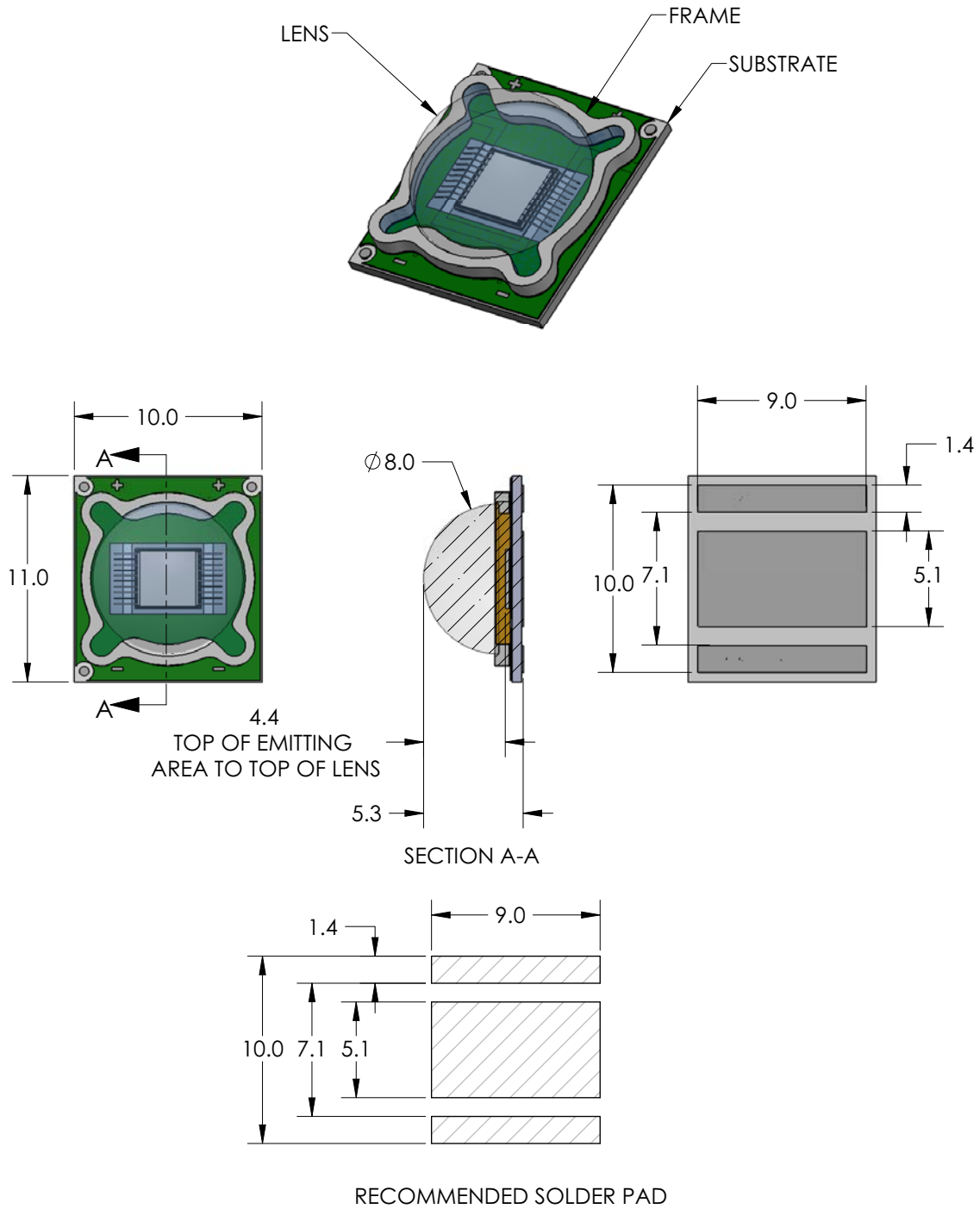

For detailed drawing of package, please refer to Luminus drawing #DWG-001277

Mechanical Dimensions - SST-90 Star

PhlatLight SST-90 red, green and blue devices are available on a star board for prototyping purposes. Please see page 14 for ordering information.

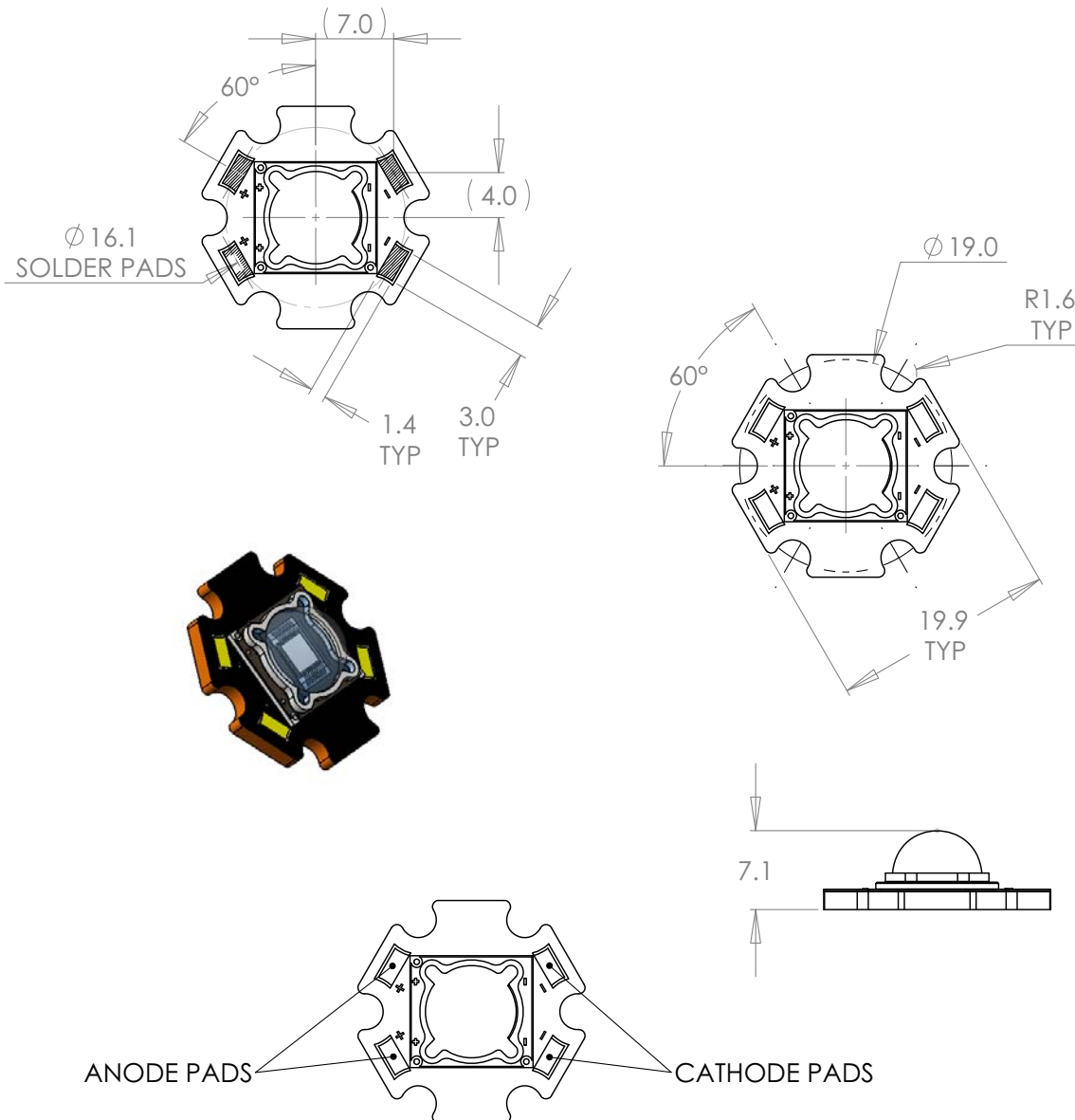

- Notes:
1. Recommended mounting screw: M3 or #4
 2. All dimensions in millimeters
 3. All anode pads on board are interconnected. All cathode pads on board are interconnected

Solder Profile

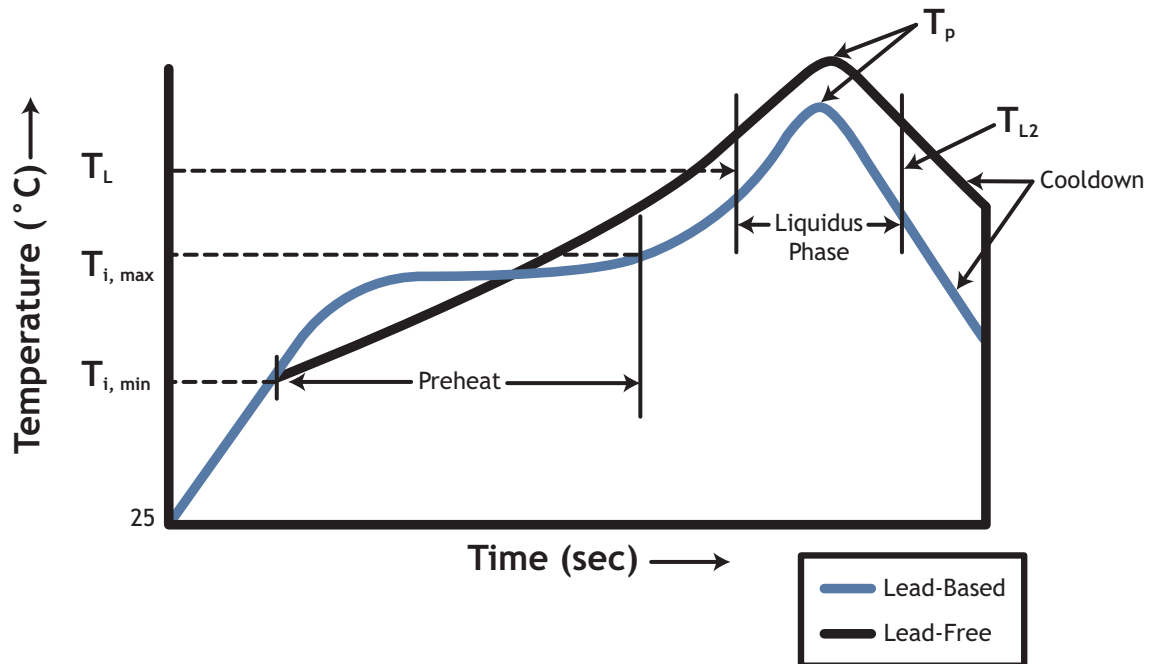

Solder Profile Stage	Lead-Free Solder	Lead-Based Solder
Rate of Rise	2°C/sec max	2°C/sec max
Preheat Min Temp ($T_{i,min}$)	100°C	120°C
Preheat Max Temp ($T_{i,max}$)	175°C	130°C
Preheat Time ($T_{i,min}$ to $T_{i,max}$)	90 seconds	120 seconds
Liquidus Min Temp: (T_L)	185°C	160°C
Liquidus to Liquidus Time (T_L to T_{L2})	30-60 seconds	30 seconds
Liquidus Peak Temp (T_p)	240°C max	220°C max
Cooldown	≤ 4°C/sec	≤ 6°C/sec
Profile Length (Ambient to Peak)	4 min	3.5 - 4 min

1. Temperatures are taken and monitored at the component copper layer
2. Optimum profile may differ due to oven type, circuit board or assembly layout
3. Recommended lead free, no-clean solder: AIM NC254-SAC305
4. Refer to soldering and handling application note for further information.

Ordering Information

Ordering Part Number ^{1,2}	Color	Description
SST-90-R-F11-HF100	Red	Red PhlatLight SST-90 consisting of a 9 mm ² LED on a surface mount substrate.
SST-90-G-F11-JE200	Green	Green PhlatLight SST-90 consisting of a 9 mm ² LED on a surface mount substrate.
SST-90-B-F11-KD300	Blue	Blue PhlatLight SST-90 consisting of a 9 mm ² LED on a surface mount substrate.
SSR-90-R-R11-HF100	Red	Red PhlatLight SSR-90 evaluation module consisting of a SST-90 surface mount device mounted on an aluminum star board.
SSR-90-G-R11-JE200	Green	Green PhlatLight SSR-90 evaluation module consisting of a SST-90 surface mount device mounted on an aluminum star board.
SSR-90-B-R11-KD300	Blue	Blue PhlatLight SSR-90 evaluation module consisting of a SST-90 surface mount device mounted on an aluminum star board.

Note 1: HF100 - denotes a bin kit comprising of all red flux and wavelength bins as listed on page 3.

JE200 - denotes a bin kit comprising of all green flux and wavelength bins as listed on page 3.

KD300 - denotes a bin kit comprising of all blue flux and wavelength bins as listed on page 3.

Note 2: For ordering information on all available bin kits, please see PhlatLight Binning and Labeling document.

www.luminus.com

The products, their specifications and other information appearing in this document are subject to change by Luminus Devices without notice. Luminus Devices assumes no liability for errors that may appear in this document, and no liability otherwise arising from the application or use of the product or information contained herein. None of the information provided herein should be considered to be a representation of the fitness or suitability of the product for any particular application or as any other form of warranty. Luminus Devices' product warranties are limited to only such warranties as accompany a purchase contract or purchase order for such products. Nothing herein is to be construed as constituting an additional warranty. No information contained in this publication may be considered as a waiver by Luminus Devices of any intellectual property rights that Luminus Devices may have in such information. PhlatLight® is a registered trademark of Luminus Devices, Inc., all rights reserved.

This product is protected by U.S. Patents 6,831,302; 7,074,631; 7,083,993; 7,084,434; 7,098,589; 7,105,861; 7,138,666; 7,166,870; 7,166,871; 7,170,100; 7,196,354; 7,211,831; 7,262,550; 7,274,043; 7,301,271; 7,341,880; 7,344,903; 7,345,416; 7,348,603; 7,388,233; 7,391,059; Patents Pending in the U.S. and other countries.