





SMT POWER INDUCTORS

Unshielded Drum Core - PF0581NL Series



-  **Height:** 4.42mm Max
-  **Footprint:** 10.32mm Typ x 9.32mm Max
-  **Current Rating:** up to 2.5A
-  **Inductance Range:** 10μH to 560μH
-  **260°C reflow peak temperature qualified**

Electrical Specifications @ 25°C — Operating Temperature -40°C to +125°C⁶

Part ⁵ Number	Inductance @ I _{rated} ¹ (μH TYP)	I _{rated} ² (A)	DCR (mΩ MAX)	Inductance @ 0Adc (μH ±10%)	Saturation Current ³ I _{sat} (A)	Heating ⁴ Current I _{dc} (A)
PF0581.103NL	9.5	2.50	43	10	2.50	3.25
PF0581.123NL	11	2.30	48	12	2.30	3.15
PF0581.153NL	14	2.00	60	15	2.00	2.70
PF0581.183NL	17	1.90	66	18	1.90	2.50
PF0581.223NL	21	1.70	84	22	1.70	2.25
PF0581.273NL	26	1.50	96	27	1.50	2.05
PF0581.333NL	31	1.30	115	33	1.30	1.90
PF0581.393NL	37	1.20	151	39	1.20	1.73
PF0581.473NL	45	1.10	166	47	1.10	1.65
PF0581.563NL	53	1.00	199	56	1.00	1.52
PF0581.683NL	65	0.93	233	68	0.93	1.37
PF0581.823NL	78	0.85	262	82	0.85	1.29
PF0581.104NL	95	0.76	333	100	0.76	1.16
PF0581.124NL	110	0.70	376	120	0.70	1.10
PF0581.154NL	140	0.63	500	150	0.63	0.97
PF0581.184NL	170	0.56	620	180	0.56	0.84
PF0581.224NL	210	0.53	721	220	0.53	0.79
PF0581.274NL	260	0.46	949	270	0.46	0.68
PF0581.334NL	310	0.42	1100	330	0.42	0.63
PF0581.394NL	370	0.39	1245	390	0.39	0.60
PF0581.474NL	450	0.35	1526	470	0.35	0.53
PF0581.564NL	530	0.32	1870	560	0.32	0.51

Mechanical

Schematic

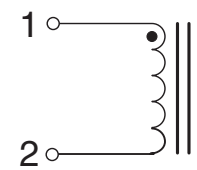
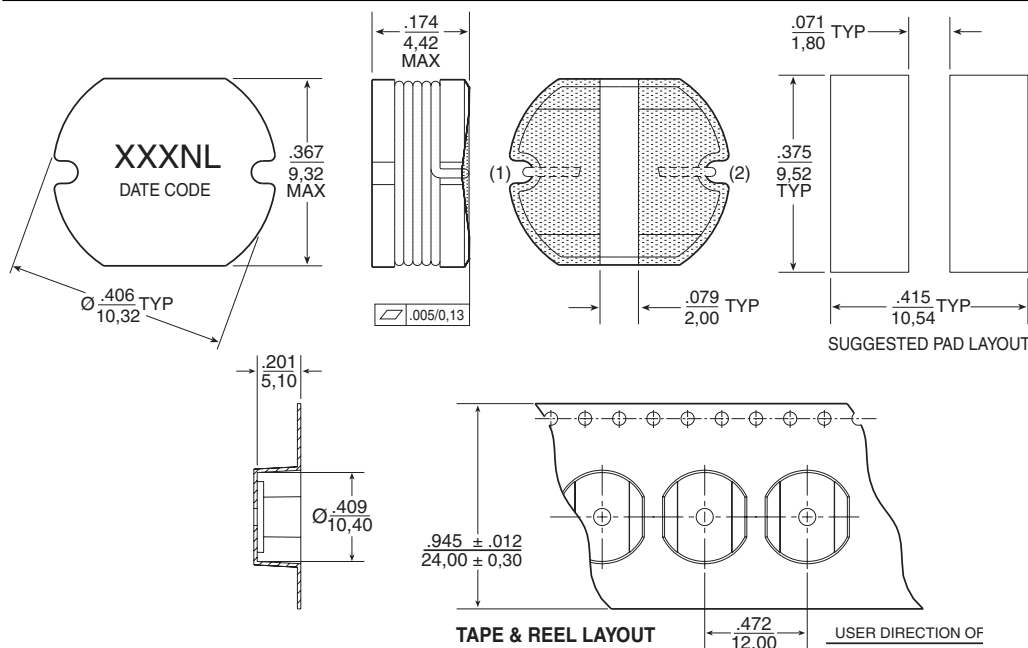

Weight 1.2 grams
Tape & Reel 900/reel

Dimensions: Inches
 mm
Unless otherwise specified,
all tolerances are ± .004
 0,10

Notes from Tables

1. Inductance at I_{rated} is a typical inductance value for the component taken at rated current.
2. The rated current listed is the lower of the saturation current @ 25°C or the heating current.
3. The saturation current, I_{sat} , is the current at which the component inductance drops by 10% (maximum) at an ambient temperature of 25°C. This current is determined by placing the component in the specified ambient environment and applying a short duration pulse current (to eliminate self-heating effects) to the component.
4. The heating current, I_{DC} , is the DC current required to raise the component temperature by approximately 45°C. The heating current is determined by mounting the component on a typical PCB and applying current for 30 minutes.
5. Optional Tape & Reel packaging can be ordered by adding a "T" suffix to the part number (i.e. PF0581.103NL becomes PF0581.103NLT). Pulse complies to industry standard tape and reel specification EIA481.
6. The temperature of the component (ambient plus temperature rise) must be within the stated operating temperature range.

Typical Inductance vs Current Characteristics

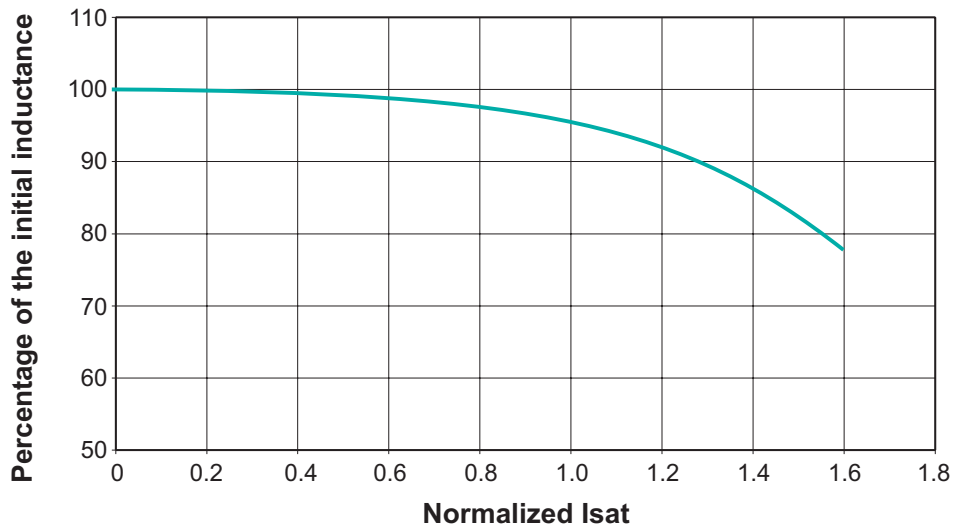

Mouser Electronics

Authorized Distributor

Click to View Pricing, Inventory, Delivery & Lifecycle Information:

Pulse:

[PF0581.104NLT](#) [PF0581.123NLT](#) [PF0581.124NLT](#) [PF0581.154NLT](#) [PF0581.183NLT](#) [PF0581.184NLT](#)
[PF0581.224NLT](#) [PF0581.273NLT](#) [PF0581.274NLT](#) [PF0581.333NLT](#) [PF0581.393NLT](#) [PF0581.394NLT](#)
[PF0581.473NLT](#) [PF0581.474NLT](#) [PF0581.563NLT](#) [PF0581.564NLT](#) [PF0581.683NLT](#) [PF0581.823NLT](#)