

IP 67  
ACCORDING TO  
EN 60529:1991+A1:2001  
IEC 60529:2001

UL US  
E 187490

RoHS  
compliant

Pb  
lead-free

## SPECIFICATIONS

**CONTACT RATING:** Dependent upon contact material See Page 135.

**MECHANICAL LIFE:** 50,000 make-and-break cycles.

**CONTACT RESISTANCE:** 20 mΩ max. initial @ 2-4VDC  
100mA for both silver and gold plated contacts.

**INSULATION RESISTANCE:** 1,000 MΩ min.

**DIELECTRIC STRENGTH:** 1,000 Vrms min. @ sea level.

**OPERATING TEMPERATURE:** -30°C to 85°C.

## MATERIALS

**CASE & BUSHING:** Glass filled nylon 6/6, flame retardand, heat stabilized ( UL94V-0 ).

**PLUNGER:** Thermoplastic Polyester (UL 94V-0), with internal O-ring seal.

**SWITCH SUPPORT:** Brass or steel electrotin plated.

**CONTACT:** Copper alloy, with silver or gold plated.  
(See Page 135)

## HOW TO ORDER

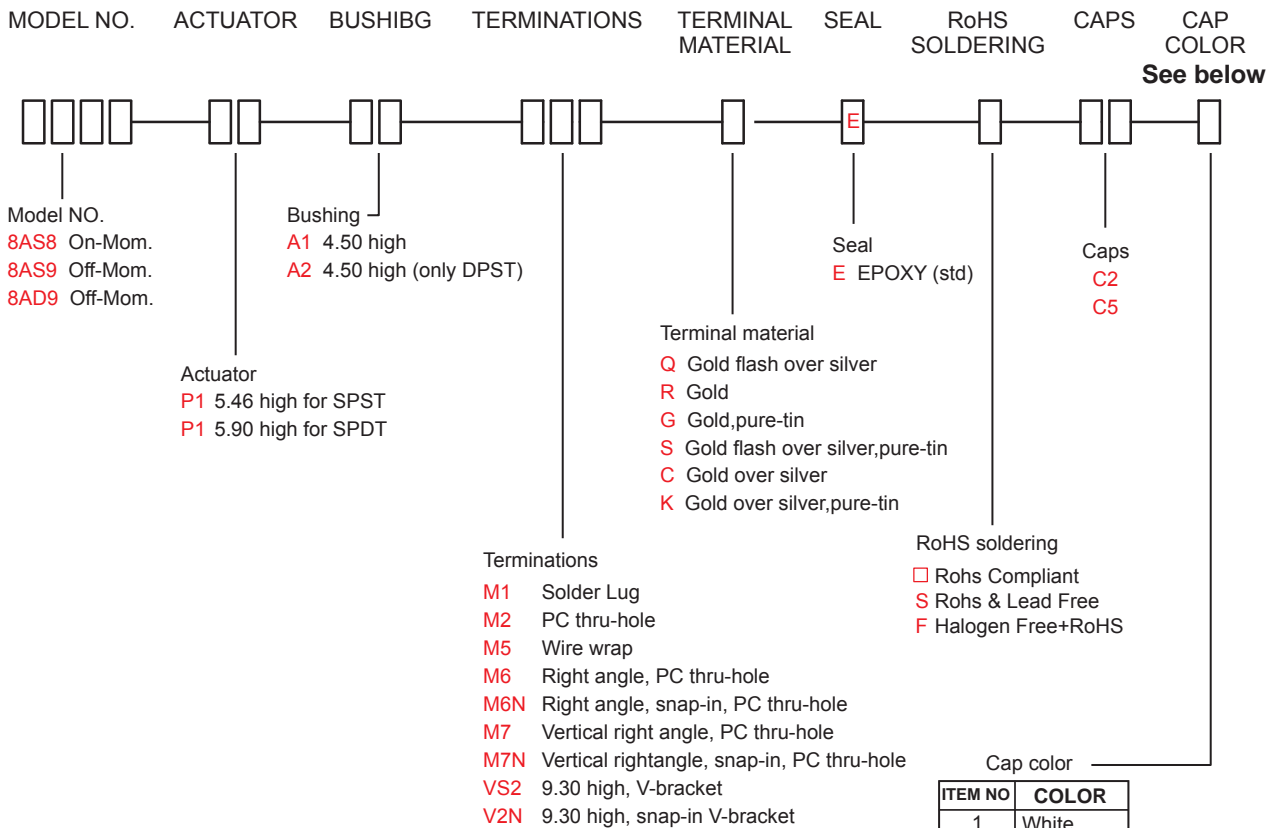

ITEM NO	COLOR
1	White
2	Black (Std)
3	Red
4	Orange
5	Yellow
6	Green
7	Blue
8	Brown
9	Gray



## SWITCH FUNCTION

NO. POLES	UL/CSA MODEL NO.	MODEL NO.	SWITCH FUNCTION		CONNECTED TERMINALS / SCHEMATIC	
			POS.1	POS.2	POS.1	POS.2
SP	Q28A18	8AS8	ON	MOM	2-1 NC 1 • 2 (COMM) • 3 NO	2-3 NC 1 • 2 (COMM) • 3 NO
	Q28A19	8AS9	OFF	MOM	OPEN	1-3 
DP	Q28A29	8AD9	OFF	MOM	OPEN	1-3,4-6 

MOM=MOMENTARY

## POLE OPTIONS

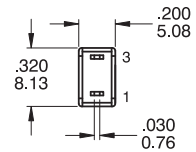
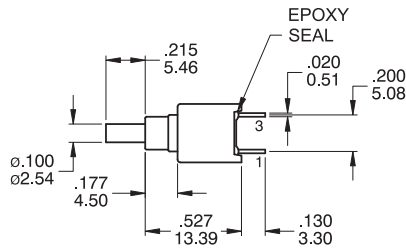
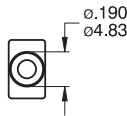

**SPST**

Part No. Shown : 8AS9P1A1M2RE

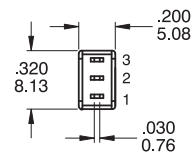
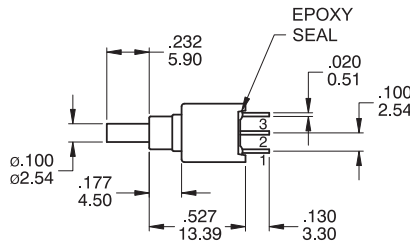
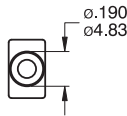

**SPDT**

Part No. Shown : 8AS8P1A1M2RE

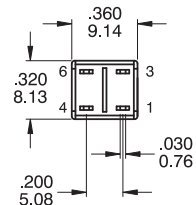
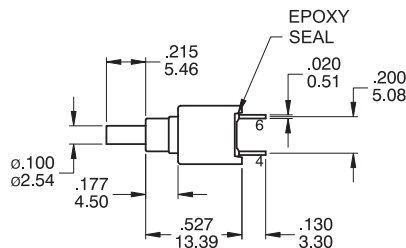
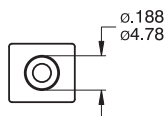

**DPST**

Part No. Shown : 8AD9P1A2M2RE

## TERMINATION OPTIONS

### M1 Solder lug

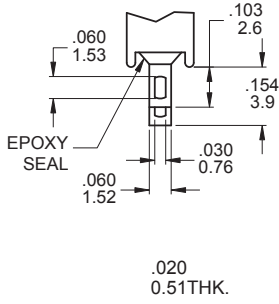

### M2 PC Thru-hole

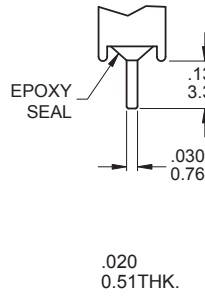

### M5 Wire Wrap

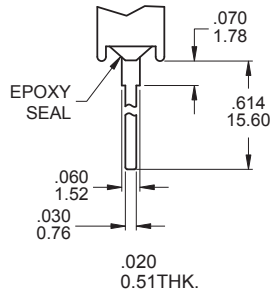

### OTHER TERMINATION OPTIONS

- M6** RIGHT ANGLE P.C. MOUNT
- M6N** RIGHT ANGLE P.C. MOUNT WITH SNP-IN BRACKET
- M7** RIGHT ANGLE P.C. MOUNT
- VS2** VERTICAL BRACKET P.C. MOUNT

### M6

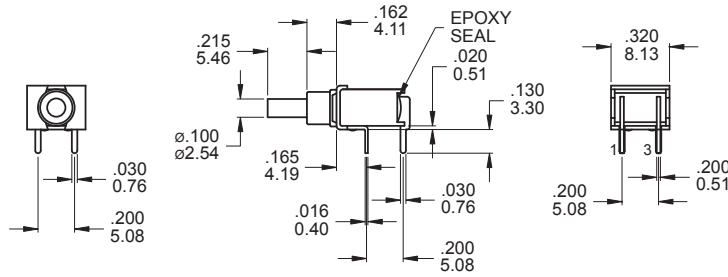

### P.C. MOUNTING

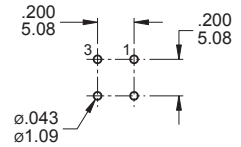

### SPST

Part No. Shown : 8AS9P1A1M6RE

### M6

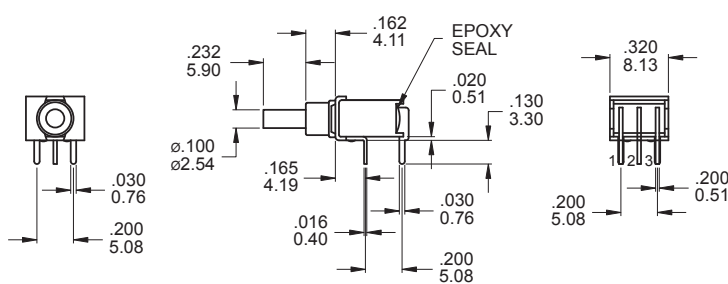

### P.C. MOUNTING

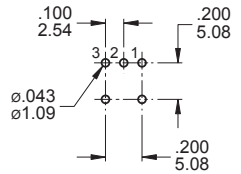

### SPDT

Part No. Shown : 8AS8P1A1M6RE

### M6

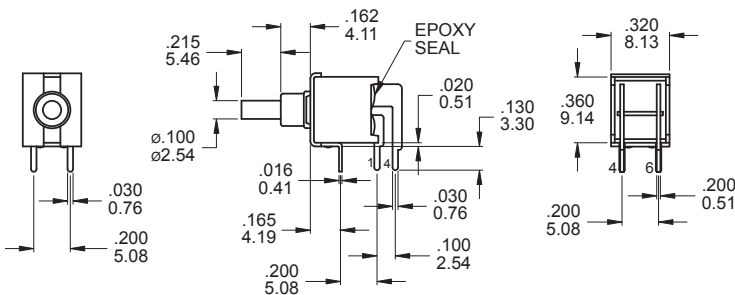

### P.C. MOUNTING

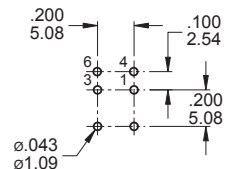

### DPST

Part No. Shown : 8AD9P1A2M6RE



## M7

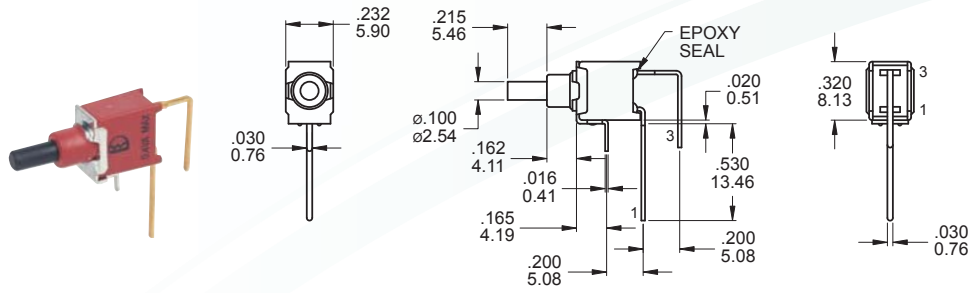

### P.C. MOUNTING

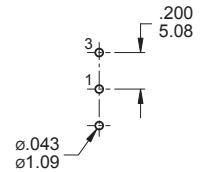

## SPST

Part No. Shown : 8AS9P1A1M7RE

## M7

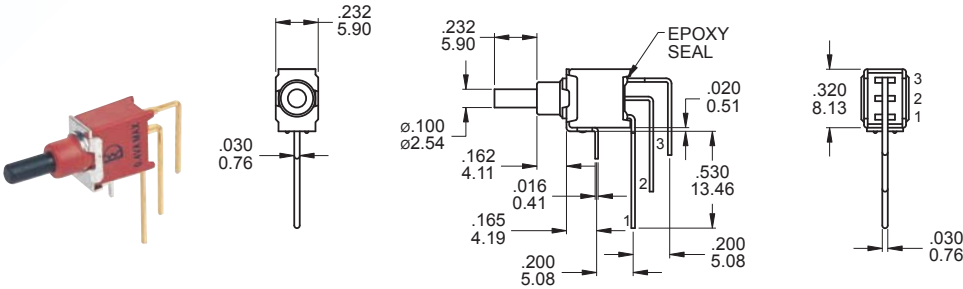

### P.C. MOUNTING

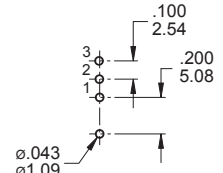

## SPDT

Part No. Shown : 8AS8P1A1M7RE

## M7

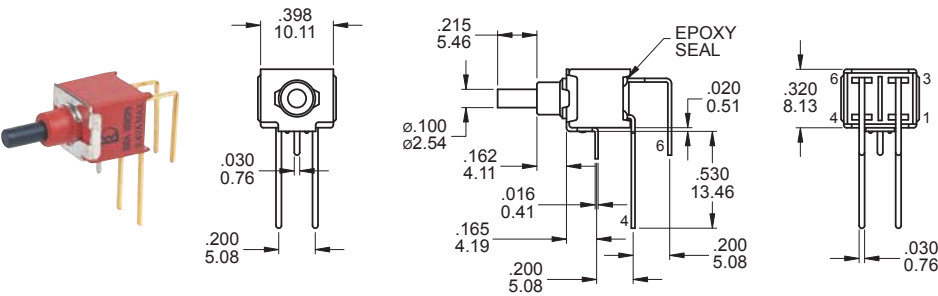

### P.C. MOUNTING

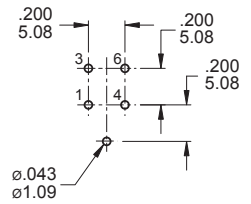

## DPST

Part No. Shown : 8AD9P1A2M7RE

## VS2

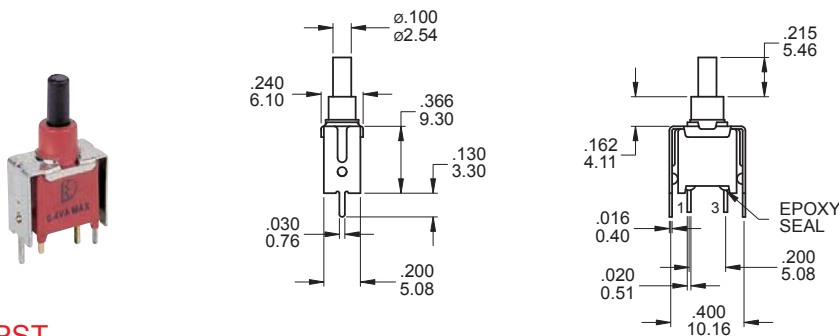

### P.C. MOUNTING

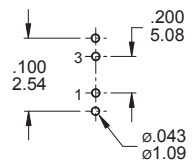

## SPST

Part No. Shown : 8AS9P1A1VS2RE

## VS2

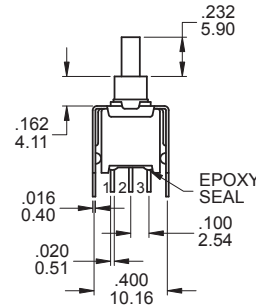
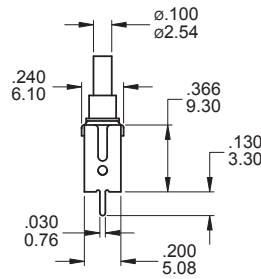

### P.C. MOUNTING

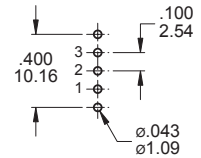

## SPDT

Part No. Shown : 8AS8P1A1VS2RE

## VS2

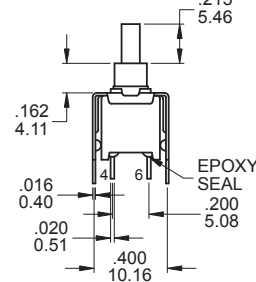
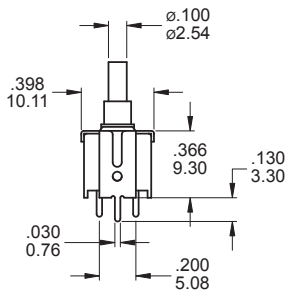

### P.C. MOUNTING

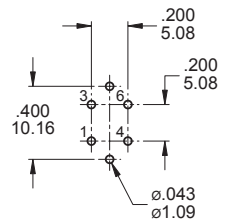

## DPST

Part No. Shown : 8AD9P1A2VS2RE

## CONTACT MATERIAL OPTIONS

	CONTACT PLATING	TERMINAL PLATING	RATINGS
Q	Silver	Q = Gold flash over silver	3 Amps with resistant load @ 120VAC or 28VDC 1 Amps with resistant load @ 250VAC
S		S = Gold flash over silver,pure - tin	
C	Gold over Silver	C = Gold over silver	
K		K = Gold over silver,pure - tin	
R	Gold	R = Gold	0.4 Volt - Amps ( VA ) max. @ 20V max. ( AC or DC )
G		G = Gold,pure - tin	

## SOLDERING PROCESSES

**MANUAL SOLDERING:** Use soldering iron of 30 watts, controlled at 350°C approximately 5 seconds while applying solder.

**WAVE SOLDERING:** Recommended Soldering Temperature: 260 ± 5°C

Duration of Solder Immersion: Max 5 sec. (PCB is 1.6mm in thickness)

