

**BU-27135-000**  
SHT 1.1

NOTES:

 LOCATED FROM TWO SURFACES FOR CUSTOMER CONVENIENCE. ONLY APPLICABLE FROM ONE SURFACE, NOT TO BE USED TOGETHER. HORIZONTAL LOCATION FOR TERMINAL CENTERED TO  $\pm 0,17$  [0.007].

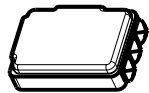
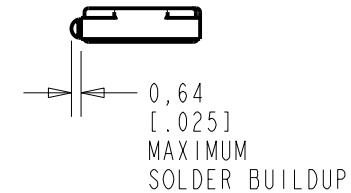
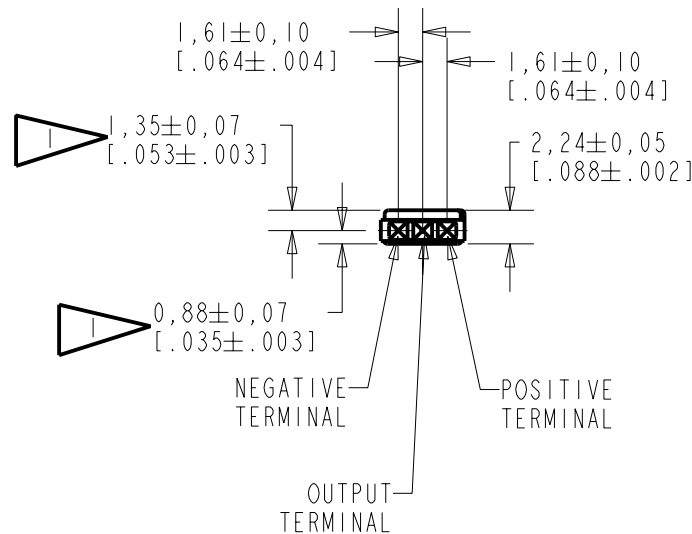
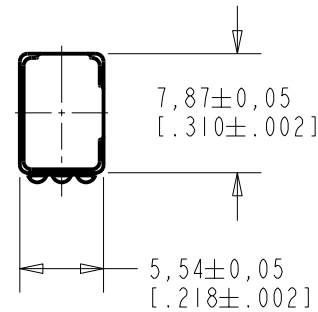

NOMINAL WEIGHT  
.28 GRAM

DIMENSIONS IN MILLIMETERS [INCHES]

**KNOWLES ELECTRONICS**  
ITASCA, ILLINOIS U.S.A.

Revision	C.O. #	Implementation Date	RELEASE LEVEL	REVISION
A	MI0101018	2-13-06	Released	A
SCALE: 2:1			DR. BY	DATE
DO NOT SCALE DRAWING			MMM	2-13-06
TITLE: VIBRATION TRANSDUCER			CK. BY	DATE
OUTLINE DRAWING			GJP	2-15-06
BU-27135-000			APP. BY	DATE
SHT 1.1			GJP	2-15-06

SENSITIVITY IN dB RELATIVE TO 1.0 V/g FOR  
CONDITIONS SHOWN BELOW

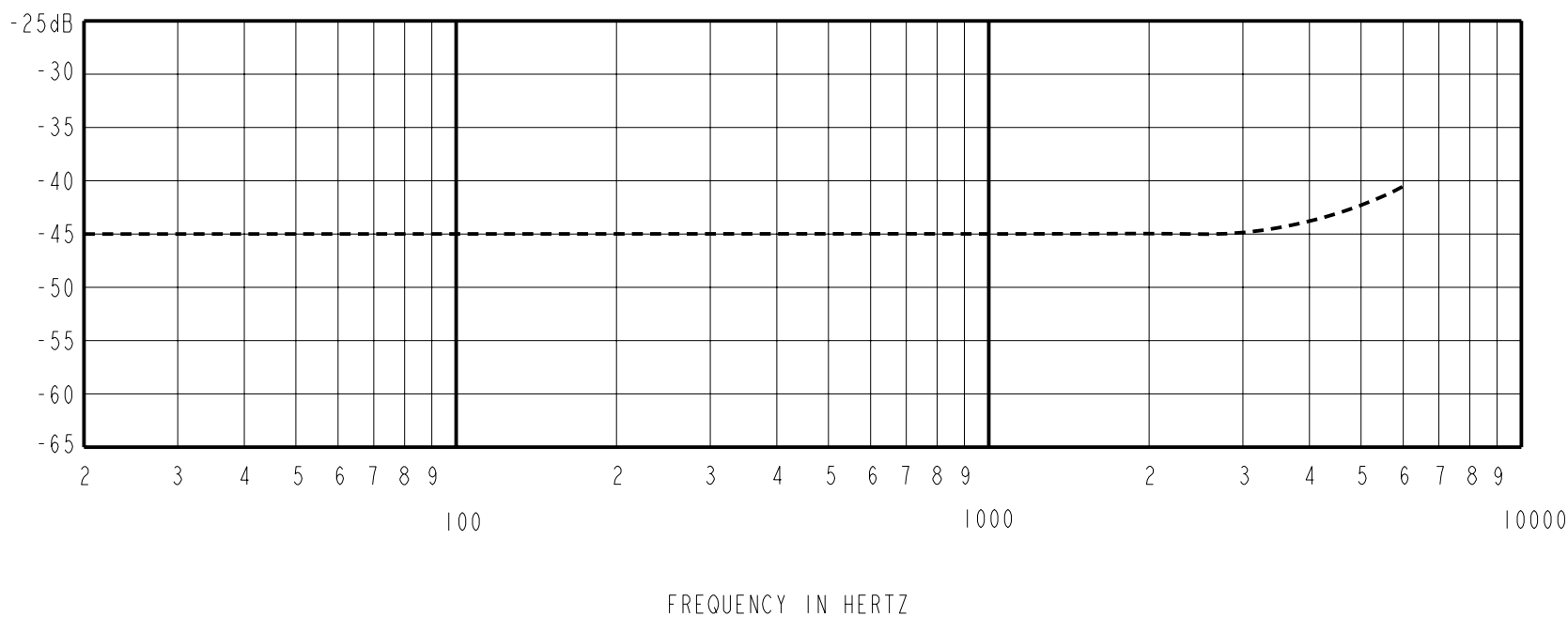

FREQUENCY	SENSITIVITY			DEVICE CONFORMITY	
	MIN.	NOM.	MAX.	RANGE OF DEVIATION FROM 3 kHz	
300	---	-45.0	---	-1.5	+1.5
1000	-49.5	-45.0	-40.5	0.0	0.0
3000	---	-44.5	---	-1.0	+2.0

NOTES:

1. ALL DATA MEASURED WITH CIRCUIT CONFIGURATION SHOWN BELOW.
2. CASE CONNECTED TO NEGATIVE TERMINAL.

DC SUPPLY	BATTERY CURRENT DRAIN	"A" WEIGHTED NOISE (RE 1.0 VOLT)	OUTPUT IMPEDANCE OHMS (AT 1 kHz)		
			MIN.	NOM.	MAX.
1.5V	0.3 mA MAX.	-103 dB MAX.	4900	5200	5500

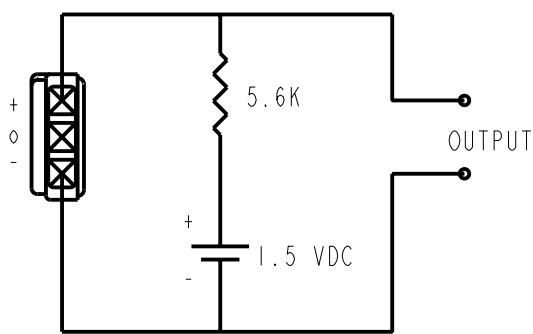

TEST CONDITIONS

Revision	C.O. #	Implementation Date	RELEASE LEVEL	REVISION
			Released	A
A	M10101018	2-13-06		

**KNOWLES ELECTRONICS**  
ITASCA, ILLINOIS U.S.A.

WHEN TEST LIMITS ARE USED TO ESTABLISH INCOMING INSPECTION ACCEPTANCE/REJECTION CRITERIA, CORRELATION OF TEST EQUIPMENT WITH KNOWLES IS ALSO REQUIRED FOR ELIMINATION OF EQUIPMENT AND TEST METHOD VARIATION

TITLE: **VIBRATION TRANSDUCER** **BU-27135-000**  
PERFORMANCE SPECIFICATION **SHT 2.1**

DR. BY	DATE
MMM	2-13-06
CK. BY	DATE
GJP	2-15-06
APP. BY	DATE
GJP	2-15-06

# Mouser Electronics

Authorized Distributor

Click to View Pricing, Inventory, Delivery & Lifecycle Information:

[Knowles:](#)

[BU-27135-000](#)