

# Keysight B2980A Series Femto/Picoammeter and Electrometer/High Resistance Meter

## Data Sheet

The world's only graphical  
Picoammeter/Electrometer  
that can confidently measure  
down to 0.01 fA and up to  
10 PΩ



## Product Overview

### Unique capabilities and features maximize confidence for sensitive measurements

Keysight B2980A Series of Femto/Picoammeters and Electrometers/High Resistance Meters not only offer best-in-class measurement performance, but also provide unprecedented features to maximize your measurement confidence. The Femto/Picoammeters and Electrometers both offer 0.01 fA ( $10^{-17}$  A) minimum current resolution, which meets virtually all existing and future low-level current measurement needs. The electrometers feature a 1,000 V voltage sourcing capability that supports up to 10 PΩ ( $10^{16}$  Ω) resistance measurements. The electrometers also work with Keysight's well-proven high resistance meter accessories. Both the Femto/Picoammeter and Electrometer have battery powered versions to eliminate AC power line noise. This available capability provides an unmatched level of noise reduction, enabling low-level measurements that were previously impossible.

Unlike conventional picoammeters and electrometers, the B2980A series possesses a 4.3" color LCD-based graphical user interface (GUI) that provides multiple options for viewing data. In addition to numeric format, data can also be viewed as a graph, as a histogram and as a trend chart. These unique front-panel capabilities facilitate the capture of transient behavior and provide the ability to make quick statistical analyses without the need for a PC. The B2980A series also has features to help you maintain measurement integrity on the external cabling and fixturing. The available Setup Integrity Checker software permits the comparison of noise levels for different cabling and fixturing arrangements, allowing you to identify and isolate the noise-sensitive areas in your measurement system. In addition to these impressive measurement capabilities, the B2980A series has easy-to-use and convenient measurement assist functions that permit users with limited or no electrical engineering training to perform complicated electrical characterization operations with ease.

To provide flexibility and enable you to purchase an instrument with the exact amount of testing capability for your needs, the Keysight B2980A series offers four product versions.



### Key Specifications

| Model                   | Femto/Picoammeter   |                 | Electrometer/<br>High Resistance Meter |                 |
|-------------------------|---|-----------------|--|-----------------|
|                         | B2981A  | B2983A          | B2985A                                 | B2987A          |
| Measurement resolution  | 6½ digits   | 6½ digits       | 6½ digits                              | 6½ digits       |
| Current measurement     | 0.01 fA - 20 mA   | 0.01 fA - 20 mA | 0.01 fA - 20 mA                        | 0.01 fA - 20 mA |
| Minimum range           | 2 pA  | 2 pA            | 2 pA                                   | 2 pA            |
| Resistance measurement  |   |                 | Up to 10 PΩ                            | Up to 10 PΩ     |
| Voltage measurement     |   |                 | 1 μV - 20 V                            | 1 μV - 20 V     |
| Input resistance        |   |                 | > 200 TΩ                               | > 200 TΩ        |
| Charge measurement      |   |                 | 1 fC - 2 μC                            | 1 fC - 2 μC     |
| Temperature measurement |   |                 | √                                      | √               |
| Humidity measurement    |   |                 | √                                      | √               |
| Voltage source          |   |                 | Up to ±1,000 V                         | Up to ±1,000 V  |
| Minimum resolution      |   |                 | 700 μV                                 | 700 μV          |
| Maximum reading rate    | 20,000 rdg/s  | 20,000 rdg/s    | 20,000 rdg/s                           | 20,000 rdg/s    |
| Battery operation       |   | √               |  | √               |
| Other key features      | Graphical capability (Meter View, Graph View, Histogram View, Roll View), Auto navigation, 100,000 points sample buffer, Interface (USB, LAN, GPIB, LXI Core), Free PC control software, etc. |                 |  |                 |

# The World's Only Graphical Picoammeter/Electrometer that can Confidently Measure Down to 0.01 fA and Up to 10 PΩ

**+0.000087 pA**

0.01 fA digit

Best-in-class 2 pA to 20 mA Current Measurement Ranges and Internal 1,000 V Sourcing Capability Ensure Accurate 0.01 fA and 10 PΩ Measurements

Battery Operation Eliminates AC Power Line Noise from Measurements

Time Domain View (Roll View) Enables Capture of Transient Signal Effects and Selection of Desired Measurement Data

Real-time Histogram Provides Quick Statistical Analysis of Measurement Data

Test Setup Integrity Checking Function and Dedicated Accessories Ensure Maximum Measurement Accuracy

## B2980A Series Key Features

- 0.01 fA ( $10^{-17}$  A) minimum measurement resolution and 2 pA to 20 mA current measurement ranges with 6.5 digits resolution
- < 20  $\mu$ V burden voltage in its lowest current range
- High speed reading rate up to 20,000 rdg/s
- Battery operation models for line noise free measurements<sup>1</sup>
- Built-in  $\pm 1,000$  V voltage source<sup>2</sup>
- Measurement resistances up to 10 PΩ ( $10^{16}$  Ω)<sup>2</sup>
- > 200 TΩ input impedance for up to 20 V voltage measurement<sup>2</sup>
- Independent current and voltage measurement<sup>2</sup>
- Charge measurement down to 2 nC range with 6.5 digits resolution<sup>2</sup>
- Temperature and humidity measurements<sup>2</sup>
- Graphical viewing modes (Meter, Graph, Histogram and Roll View)
- Easy-to-use auto navigation to select optimal range and aperture
- Optional Test Setup Integrity Checker function for noise source isolation
- Versatile interface (USB 2.0: LAN, GPIB, LXI Core)
- USB (front): store data, save/recall setup information
- Free PC control software

<sup>1</sup> B2983A and B2987A

<sup>2</sup> B2985A and B2987A

## Application examples

- Material science (Biomaterials, ceramics, elastomers, films, dielectric materials, electrochemical, ferroelectric materials, graphene, metals, organic materials, nano-materials, polymers, semiconductors, etc.)
- Devices & electronic components (capacitors, resistors, diodes, sensors, transistors including TFT and CNT, optoelectronics, solar cells, etc.)
- Electronic/non-electronic systems (ion beam, electron beam, sensing systems, particle measurements, embedded precision instruments, etc.)

## Why is 0.01 fA resolution important?

Many materials science and device characterization applications require the ability to measure very small currents that conventional DMMs (digital multi-meters) cannot handle. Since the B2980A series provides a best-in-class 0.01 fA current measurement resolution in both its femto/picoammeter and electrometer versions, it can perform precise and detailed measurements that were previously impossible using conventional picoammeters and electrometers. Therefore, you are assured that your current measurement requirements will be met well into the future.

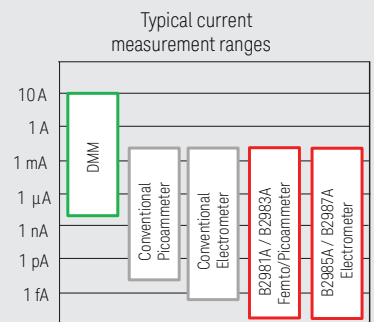

## The B2980A series' unmatched 0.01 fA resolution combines with other unique features to solve previously intractable measurement challenges

**Challenge 1: Instruments that only have numeric displays do not give you any control over when to take data during a transient response.**

### Solution 1: The B2980A series' time domain view (Roll View) lets you visually choose when to capture data.

The B2980A series' GUI provides a Roll View that can graphically display data as it is taken and that also can store up to 100,000 of these data points for later retrieval. With a sampling rate of up to 100 kHz, the Roll View can reveal real-time measurement trends and provide valuable insights into the dynamics of your DUT's behavior. To facilitate this data analysis, the B2980A series provides flexible graphing capabilities. In Graph View the electrometers can plot I-V curves on their displays using values from either the internal voltage source or voltage measurement data. In addition, it is easy to generate a variety of other X-Y plots such as I-t, V-t, R-t, Q-t, I-R, etc. (specific graphical display capabilities depend on product model). These powerful and versatile graphical capabilities allow you to gain valuable insights when making sensitive measurements.

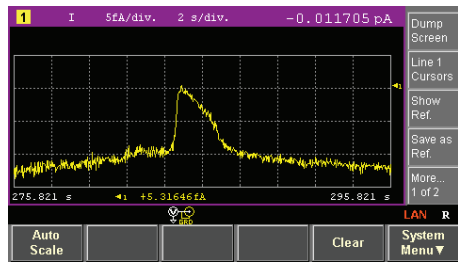

Time domain view (Roll View)

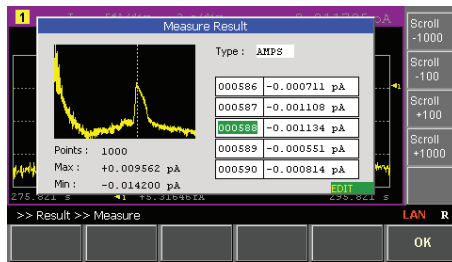

Data recorded up to 100,000 points

**Challenge 2: Instruments with only numeric displays often exhibit instability in their least significant digits and offer no information about the measurement's mean and standard deviation.**

### Solution 2: You can instantly view and evaluate data distributions using the real-time histogram feature

All low-level measurements carry with them a degree of statistical uncertainty due to inherent fluctuations in the measurement environment. The conventional method to deal with this issue involves post-measurement evaluation of the data (usually on a PC) using a histogram. However, this process can become tedious if you need to perform several measurement and test setup debug cycles.

### How fast can the B2980A series capture data?

Measurement speed is usually determined by the aperture time of the integration setting, which is typically proportional to some number of power line cycles (PLCs). Smaller aperture times are obviously more desirable as long as they provide sufficient averaging to prevent power line noise from affecting the measurement.

However, conventional instruments often cannot capture fast transients due to their relatively slow reading rates that require long overhead after the aperture closes. In contrast, the B2980A series' fast reading rate (20,000 rdg/s) and streamlined system architecture greatly reduce overhead time. As a result the B2980A series does not lose data sampling capability even in its minimum PLC setting, allowing it to capture more detailed DUT responses. The example below compares the data sampling capability of a conventional instrument with that of the B2980A series. As this example shows, the B2980A series can capture data with x4 better timing resolution due to its low measurement overhead.

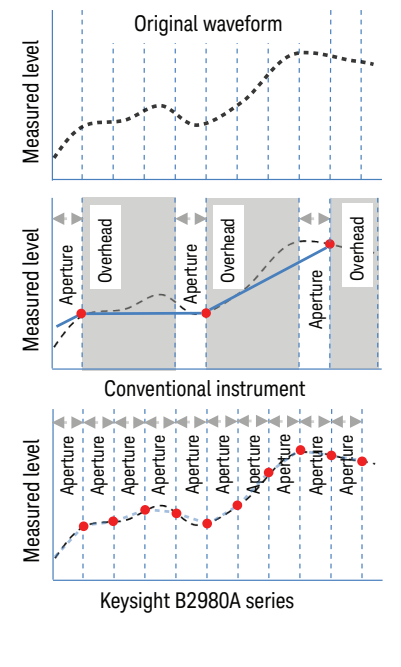

In contrast the B2980A's real-time and auto-scalable histogram display capability continuously updates the mean and sigma, enabling you to debug your measurement setup instantly without the need for any post-measurement data crunching. The histogram can be displayed in the Meter View, allowing you to compare accumulated data on the histogram with real-time numeric data. Note: The maximum number of data points supported by the histogram is 100,000.

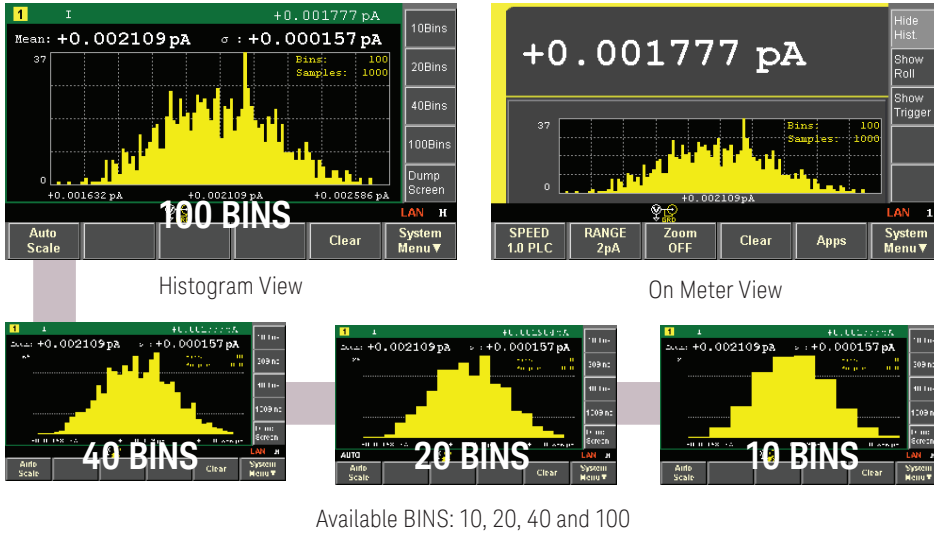

### How much lower is the B2980A series' noise floor?

Even when operating in AC mode with 0.1 PLC integration time, the B2980A series' advanced design provides current measurement performance that is much better than conventional picoammeters and electrometers. The graph shown below compares current measurement noise levels under identical measurement conditions. As can be seen the B2980A series can make both lower noise and faster measurements, which reduces the trade-offs that normally need to be made between these two goals.

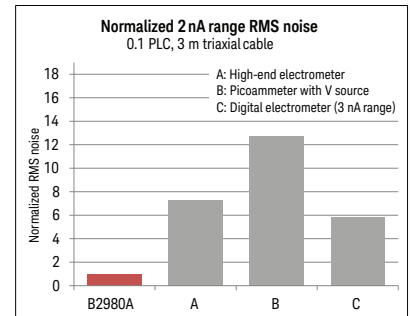

**Challenge 3: Eliminating noise from low-level measurements is difficult and often requires extensive measurement expertise.**

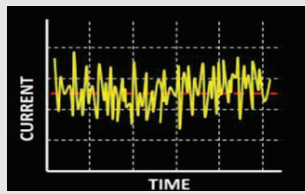

**Solution 3: The B2980A series' battery operated models eliminate power line noise and enhance low noise measurement performance.** AC power line noise strongly impacts sensitive measurements. While integrating over one or more PLCs can minimize AC power line noise effects, even the B2980A's excellent noise performance cannot eliminate 100% of this noise unless the instrument is completely isolated. Therefore, both the Femto/Picoammeter and Electrometer have available battery operated versions that enable you to make power-line-noise-free measurements. The two battery models can function for 7 hours (B2983A) or 5 hours (B2987A) under normal operating conditions, and they also automatically save your measured data and measurement setup information if the battery level goes below 5%. Of course, besides eliminating noise the battery models provide the added benefit of portability allowing you to use them anywhere you want.

### What makes Keysight triaxial cables superior?

Triaxial cables, which are available from a variety of sources, are required for low-current measurement applications. Keysight triaxial cables employ a semiconductor layer between the insulator and inner jacket, which minimizes the triboelectricity generated by friction at these boundaries. The net result is that Keysight triaxial cables are largely unaffected by cable vibration, which enables more accurate and stable measurements. All B2980A products come with a 1.5 meter version of this triaxial cable.

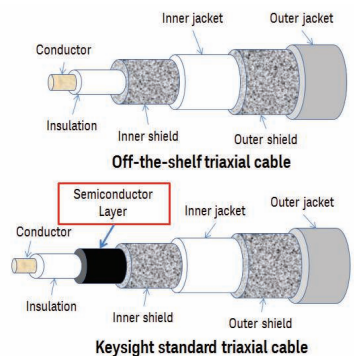
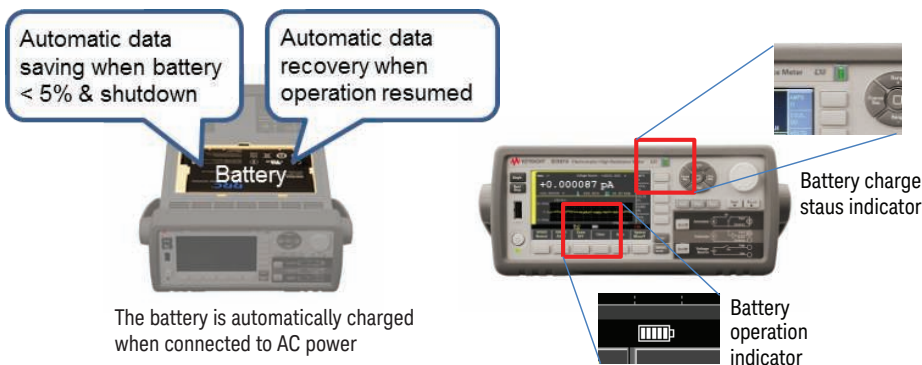

**Challenge 4: Verifying the integrity of measurement cabling is essential for accurate measurements, but conventional instruments do not offer any means to validate cable performance.**



**Solution 4: Optional software and dedicated accessories help mitigate cabling complexities**

When performing sensitive measurements making appropriate cabling connections is often one of the more difficult challenges. Many factors can contribute to measurement noise or instability, including incorrect cabling, poor cable quality and improper guarding; however, determining the root cause of a measurement fixturing issue from among all of these factors is not easy. Conventional instruments do not provide any help to solve these types of issues and they typically only offer written guidance on best practices. In contrast, the B2980A series has an available Setup Integrity Checker function that can identify noise caused by external elements (cables, adapters, shields, chambers, etc.) and display the information in tabular format on the front-panel GUI. As shown below, the setup integrity checker function allows you to compare the noise level of the instrument with no cables connected against the noise level with different setup elements connected. By comparing the noise level standard deviation of different setup elements side by side, you can easily determine the quality of cables and other setup elements necessary for your measurements.

The B2980A series also has specialized accessories available to facilitate certain types of measurements. For example, the N1413A High Resistance Meter Fixture Adapter allows you to use the B2980A series with Keysight's accessories for high resistance measurement (such as the 16008B Resistivity Cell). A High Resistance Measurement Universal Adapter (N1414A) is also available to simplify the cabling for high resistance measurements.

**How much faster is the B2980A series' settling time?**

When comparing instrument settling times, you need to understand how each instrument defines this specification. Most conventional instruments define settling time as the time it takes to reach 10% of the final value, whereas the B2980A series uses a value of 0.1%. By reducing dielectric absorption (DA), the B2980A achieves a faster settling time using the 0.1% limit even in its lower measurement ranges as shown below.

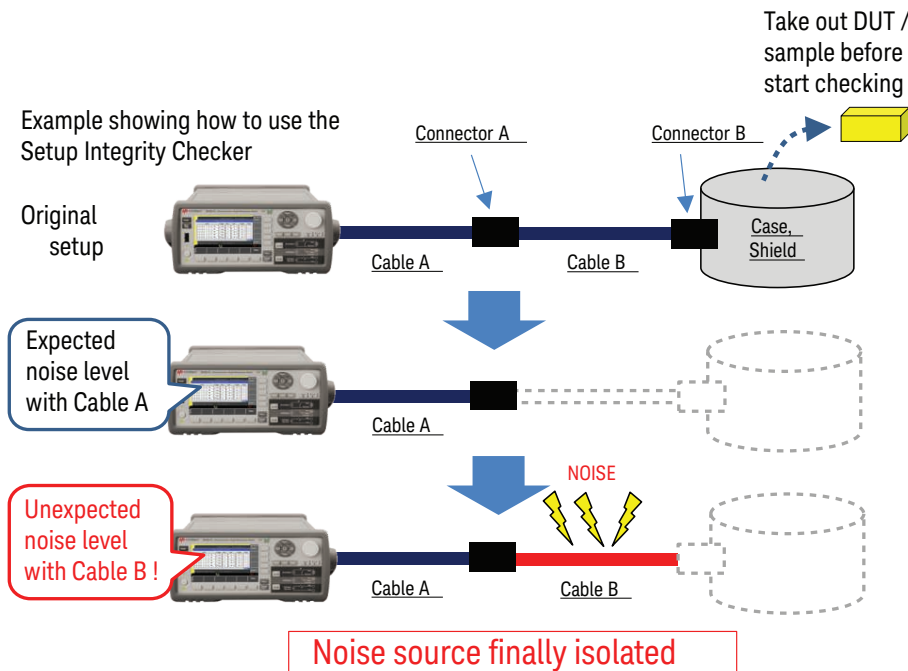
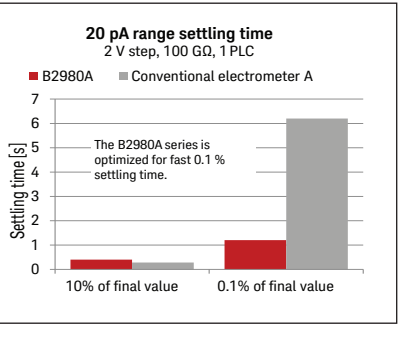
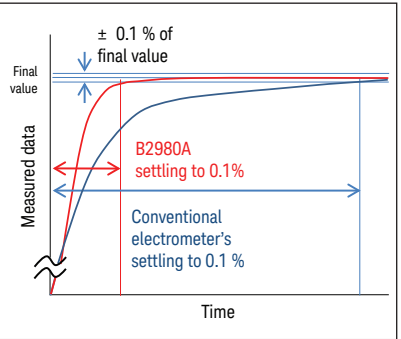

## Innovative measurement functions enable both novice and experienced users to utilize all of the B2980A series' powerful measurement capabilities.

### Measurement assist functions reduce low-level measurement challenges

Selecting the appropriate range and aperture time for low-level measurements is not always straightforward, since these settings are affected by both target device or sample characteristics and measurement conditions (noise, temperature, humidity, etc.). For these reasons, selecting the optimal test settings can be challenging for even experienced users. However, the B2980A series has a variety of assist functions to improve your measurement productivity.

The navigation keys enable you to easily find the optimal measurement range and aperture time (speed) parameters. The column at the right shows how the navigation keys work.

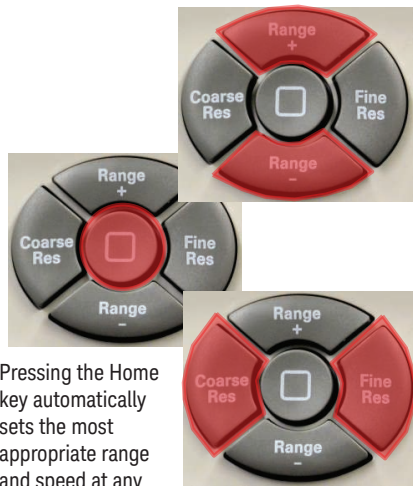

Pressing the Home key automatically sets the most appropriate range and speed at any time

| Current Measurement | Voltage Measurement | Resistance Measurement | Charge Measurement |
|---------------------|---------------------|------------------------|--------------------|
| 20 mA               | 20 V                | 1 P Ω                  | 2 μC               |
| 2 mA                | 2 V                 | 100 T Ω                | 200 nC             |
| 200 μA              |                     | 10 T Ω                 | 20 nC              |
| 20 μA               |                     | 1 T Ω                  | 2 nC               |
| 2 μA                |                     | 100 G Ω                |                    |
| 200 nA              |                     | 10 G Ω                 |                    |
| 20 nA               |                     | 1 G Ω                  |                    |
| 2 nA                |                     | 100 M Ω                |                    |
| 200 pA              |                     | 10 M Ω                 |                    |
| 20 pA               |                     | 1 M Ω                  |                    |
| 2 pA                |                     |                        |                    |

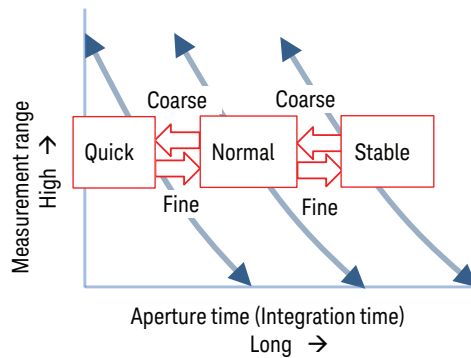

### How does the Navigation feature work?

The B2980A series possesses an innovative measurement navigation capability that helps users optimize both aperture time and measurement range. As shown below, it has three pre-programmed range vs. aperture curves that cover most logical combinations. By default measurements start using the "Normal" curve and an appropriate measurement range. However, if the measured data seems noisy then pressing the "Fine Res" key switches the settings over to the "Stable" curve. This will automatically adjust the settings to a longer aperture time and reduce the noise. In addition, if you need to make a rough measurement quickly then switching over to the "Quick" curve will save measurement time.

The Navigation feature's pre-defined curves enable even novice engineers and researchers to make low-level measurements quickly without any need to struggle over selecting the appropriate aperture time and range settings. Of course, experienced users can override these curves and use the instrument in purely manual mode if a particular measurement requires customized settings.

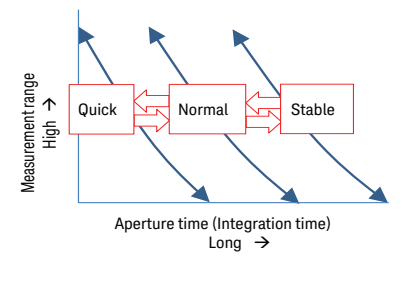

The "Save" and "Recall" keys ensure that you never lose setup parameters obtained through prolonged trial-and-error.

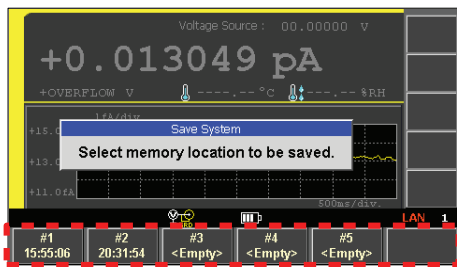

The "Save" and "Recall" keys located below the rotary knob enable you to instantly save and recall all test setup parameters to/from one of five available storage buffers.

## Free PC-based software and multiple interface options provide flexible remote control choices

Keysight provides two PC-based software control options for the B2980A series: B2900A Quick IV Measurement Software and a B2900A Graphical Web Interface. Quick IV software can communicate with the B2980A series via several popular interfaces: LAN, GPIB (up to four B2980A series units) and USB (one B2980A series unit). It provides almost the same functionalities of your B2980A series' front panel. In addition, it supports a function that can automatically export measurement data into Microsoft Excel on your PC for further analysis. The Web Interface is embedded in each instrument and is only accessible via the LAN interface using a PC.

The Quick IV Measurement Software also supports other B2900A precision instrument products (B2900A series of Source / Measure Units and B2960A series of Low Noise Power Sources).

PC connected via GPIB, LAN or USB

Keysight B2900A Quick IV Measurement Software

Keysight B2980A Graphical Web Interface

B2980A series Femto/Picoammeter Electrometer

## What are the B2980A series' temperature and humidity measurement capabilities?

Temperature and humidity are critical parameters for high resistance measurements. The B2985A and B2987A electrometers contain both temperature and humidity sensor interfaces, and a dedicated thermocouple (N1423A) is furnished with these models. The EE07 Digital Humidity/Temperature Probe from E+E Elektronik can be used for humidity and temperature sensing, which provides more accurate temperature data than a thermocouple

## For more information

Please visit the product web pages containing demo videos, application information, sample programs, etc. from: [www.keysight.com/find/b2980a](http://www.keysight.com/find/b2980a)



## Ready-to-use instrument drivers simplify programming

For users that want to create their own customized software, IVI-C and IVI-COM drivers for the B2980A series are available. In addition, National Instrument's LabVIEW drivers are also available at NI.COM.

## Keysight B2900A family

The B2980A series is a member of B2900 Precision Instrument Family, which provide a variety of precision measurement solutions with both sourcing and measurement capabilities. The B2900A series of Source Measure Units (SMUs) have 6.5-digit resolution, enabling 100 nV/10 fA sourcing and measurement. The B2960A series of Low Noise Power Sources have up to 6.5-digit voltage/current sourcing resolution and a 10  $\mu$ Vrms noise floor. Both the B2900A series SMUs and B2960A series Power Sources have an output range of  $\pm 210$  V and  $\pm 3$  A (DC) or  $\pm 10.5$  A (pulsed), and they both utilize the same color LCD-based GUI. Further information on the B2900 Precision Instrument Family is available at <http://www.keysight.com/find/b2900a>.



B2900A Source Measure Unit



B2960A Low Noise Power Source



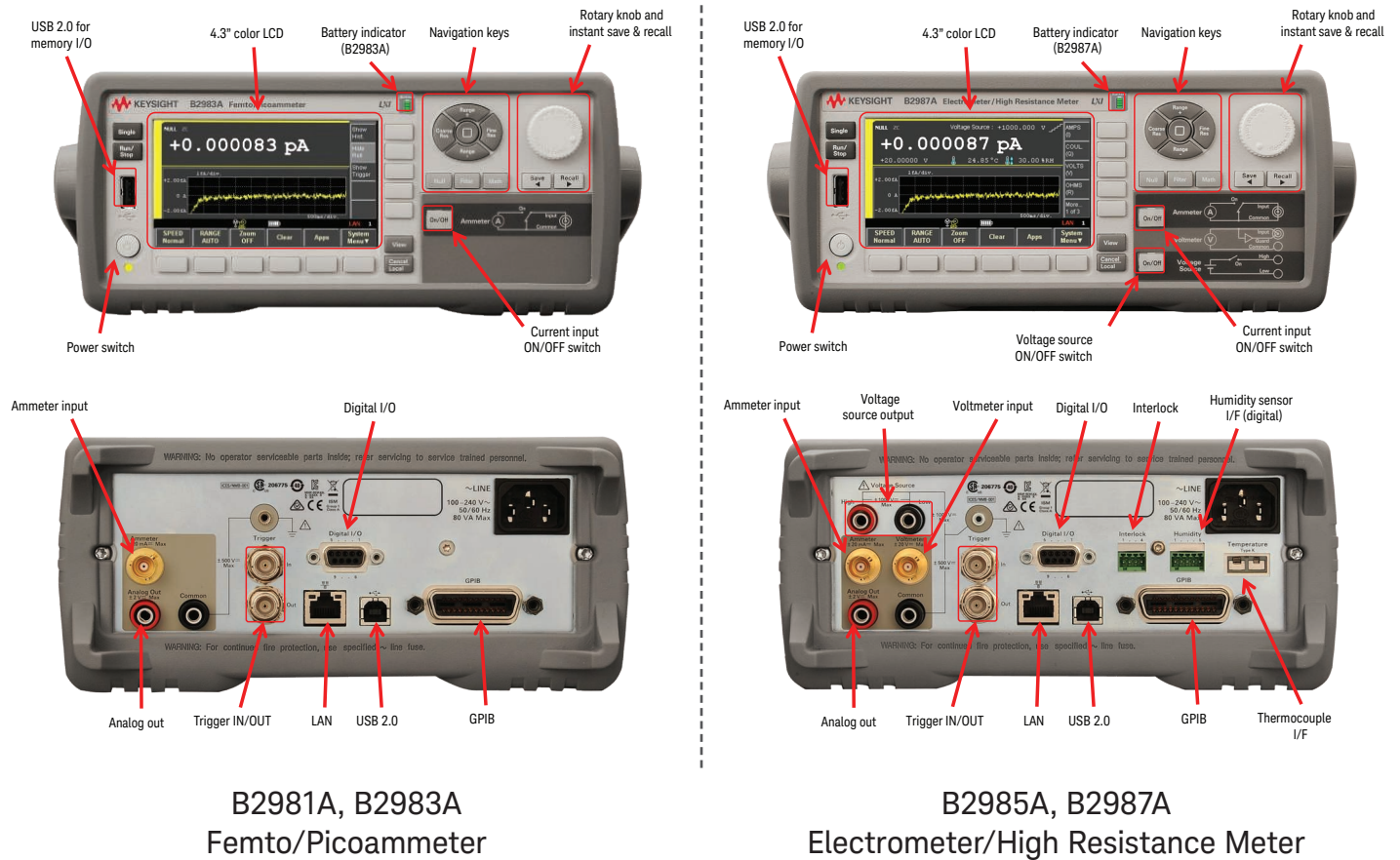

## Compatibility table for optional high performance accessories and productivity tools

| Product   | Femto/Picoammeter      |                        | Electrometer/High Resistance Meter |                        |
|---|------------------------|------------------------|------------------------------------|------------------------|
|   | B2981A                 | B2983A                 | B2985A                             | B2987A                 |
| 16494A Triaxial cable<br>(0.4 m, 0.8 m, 1.5 m, 3 m, 4 m)              | ✓<br>(1.5 m furnished) | ✓<br>(1.5 m furnished) | ✓<br>(1.5 m furnished)             | ✓<br>(1.5 m furnished) |
| N1413A High resistance meter<br>fixture adapter                       |                        |                        | ✓                                  | ✓                      |
| N1414A High resistance measure-<br>ment universal adapter             |                        |                        | ✓                                  | ✓                      |
| 16008B Resistivity cell   |                        |                        | ✓                                  | ✓                      |
| N1418A Lithium-ion battery pack                                       |                        | ✓<br>(furnished)       |                                    | ✓<br>(furnished)       |
| N1420A Setup integrity checker for<br>B2980 series (software license) | ✓                      | ✓                      | ✓                                  | ✓                      |



## Technical Specifications and Characteristics

### Specification conditions

Temperature: 23 °C ± 5 °C

Humidity: 30% to 80% RH

After 1 hour warm-up

Ambient temperature change: less than ± 3 °C after self-calibration

Calibration period: 1 year

### Current measurement

| Measurement range                                | Display resolution | Accuracy<br>±(% + offset) | Input burden voltage at<br>SelfCal ±3°C <sup>1</sup> | measurement settling<br>time <sup>1,2</sup> |
|--|--------------------|---------------------------|--|---|
| 2 pA   | 1 aA               | 1 + 3 fA                  | 20 μV  | 16 s  |
| 20 pA  | 10 aA              | 0.5 + 3 fA                | 20 μV  | 1.4 s                                       |
| 200 pA   | 100 aA             | 0.5 + 5 fA                | 20 μV  | 1.4 s                                       |
| 2 nA   | 1 fA               | 0.2 + 300 fA              | 20 μV  | 13 ms                                       |
| 20 nA  | 10 fA              | 0.2 + 500 fA              | 20 μV  | 13 ms                                       |
| 200 nA   | 100 fA             | 0.2 + 5 pA                | 20 μV  | 1.2 ms                                      |
| 2 μA   | 1 pA               | 0.1 + 50 pA               | 20 μV  | 550 μs                                      |
| 20 μA  | 10 pA              | 0.05 + 500 pA             | 20 μV  | 600 μs                                      |
| 200 μA   | 100 pA             | 0.05 + 5 nA               | 100 μV   | 600 μs                                      |
| 2 mA   | 1 nA               | 0.05 + 50 nA              | 1 mV   | 100 μs                                      |
| 20 mA  | 10 nA              | 0.05 + 500 nA             | 6 mV   | 100 μs                                      |
| Temperature coefficient 0 to 18°C and 28 to 45°C |                    | ± (0.05 x Accuracy) /°C   |  |   |

### Supplemental characteristics

|   |  |
|---|--|
| Temperature coefficient of input voltage burden | < 10 μV/°C on pA, nA and μA ranges                       |
| RMS noise                                       | 140 aA for 2 pA range, 10 s duration, no cable, open cap |
| NMRR <sup>3</sup>                               | > 60 dB  |
| Maximum input capacitance                       | 10 nF on less than 20 μA ranges, 1 μF on other ranges    |

### NOTES

Conditions: properly zeroed, 6½-digit, 1 PLC, median filter on, moving average 10 points

- Supplemental characteristics
- 0.1 % of final value
- Normal mode rejection ratio, integration time = 1, 2, ..., 100 PLC; power line frequency ± 0.1%

### Resistance measurement

| Measurement range                                | Display resolution | Accuracy ±(% + offset) <sup>1,2</sup> | Auto voltage source | Current measure range |
|--|--------------------|---------------------------------------|---------------------|-----------------------|
| 1 MΩ   | 1 Ω                | 0.135 + 1 Ω                           | 20 V                | 200 μA                |
| 10 MΩ  | 10 Ω               | 0.135 + 10 Ω                          | 20 V                | 20 μA                 |
| 100 MΩ   | 100 Ω              | 0.185 + 100 Ω                         | 20 V                | 2 μA                  |
| 1 GΩ   | 1 kΩ               | 0.285 + 1 kΩ                          | 20 V                | 200 nA                |
| 10 GΩ  | 10 kΩ              | 0.285 + 10 kΩ                         | 20 V                | 20 nA                 |
| 100 GΩ   | 100 kΩ             | 0.41 + 100 kΩ                         | 20 V                | 2 nA                  |
| 1 TΩ   | 1 MΩ               | 0.45 + 1 MΩ                           | 200 V               | 2 nA                  |
| 10 TΩ  | 10 MΩ              | 0.625 + 10 MΩ                         | 200 V               | 200 pA                |
| 100 TΩ   | 100 MΩ             | 0.75 + 100 MΩ                         | 200 V               | 20 pA                 |
| 1 PΩ   | 1 GΩ               | 2.6 + 1 GΩ                            | 200 V               | 2 pA                  |
| Temperature coefficient 0 to 18°C and 28 to 45°C |                    | ± (0.1 x Accuracy) /°C                |                     |                       |

### NOTES

Conditions: Auto V-source ohms, properly zeroed, 6½-Digit, 1 PLC, median filter on, digital filter = 10 readings.

- In the manual mode resistance can be calculated from specific source voltage and measured current. The measurement accuracy in the manual mode is determined by voltage source accuracy and ammeter accuracy as follows: Measurement Error = R reading x (Voltage % error + Voltage offset error / Voltage + Current measurement % error + 10 x Current measurement offset error / Current measurement range)
- Current measurement range for both Auto and Manual modes: 10% of current range ≤ measured current ≤ 100% of current range

| Voltage measurement                              |                    |                             |
|--|--------------------|-----------------------------|
| Measurement range                                | Display resolution | Accuracy $\pm$ (% + offset) |
| 2 V  | 1 $\mu$ V          | 0.025 + 40 $\mu$ V          |
| 20 V   | 10 $\mu$ V         | 0.025 + 400 $\mu$ V         |
| Temperature coefficient 0 to 18°C and 28 to 45°C |                    | $\pm$ (0.05 x Accuracy) /°C |

| Supplemental characteristics |  |
|------------------------------|--|
| Input bias current           | < 20 fA  |
| Input impedance              | > 200 T $\Omega$ , parallel with < 20 pF (non-guarded) or < 2 pF (guarded) |
| RMS noise                    | 1.4 $\mu$ V for 2 V range, 10 s duration, shorted input                    |
| NMRR <sup>1</sup>            | > 60 dB  |
| CMRR <sup>2</sup>            | > 140 dB at DC; > 70 dB at 50 Hz or 60 Hz                                  |

**NOTES**

Conditions: properly zeroed, 6½-digit, 1 PLC

1. Normal mode rejection ratio, integration time = 1, 2, ..., 100 PLC; power line frequency  $\pm$  0.1 %
2. Common mode rejection ratio: 1 k $\Omega$  LO lead unbalance. Add the NMRR for PLC integration time.

| Charge measurement                               |                    |  |
|--|--------------------|--|
| Measurement range                                | Display resolution | Accuracy <sup>1</sup> $\pm$ (% + offset) |
| 2 nC   | 1 fC               | 0.4 + 50 fC                              |
| 20 nC  | 10 fC              | 0.4 + 500 fC                             |
| 200 nC   | 0.1 pC             | 0.4 + 5 pC                               |
| 2 $\mu$ C  | 1 pC               | 0.4 + 50 pC                              |
| Temperature coefficient 0 to 18°C and 28 to 45°C |                    | $\pm$ (0.1 x Accuracy) /°C               |

**NOTES**

Conditions: Properly zeroed, 6½-digit, 1 ms aperture, specifications apply at 1 to 10 ms after charge acquisition.

1. Add 6 fC/s to the accuracy specification for the time span between NULL and measurement

| Voltage source                                   |                    |  |                             |  |  |
|--|--------------------|--|-----------------------------|--|--|
| Sourcing range                                   | Display resolution | Accuracy $\pm$ (% + offset)                                  | Output current <sup>1</sup> | Output Noise <sup>2</sup>  | Settling time to rated accuracy <sup>1,3</sup> |
| 20 V   | 700 $\mu$ V        | 0.05 + 2 mV  | $\pm$ 20 mA                 | 55 $\mu$ Vp-p<br>(0.1 Hz to 10 Hz)<br>1.6 mVrms<br>(10 Hz to 20 MHz) | 200 $\mu$ s                                    |
| 1000 V   | 35 mV              | 0.05 + 100 mV  | $\pm$ 1 mA                  | 2.6 mVp-p<br>(0.1 Hz to 10 Hz)<br>3.0 mVrms<br>(10 Hz to 20 MHz)     | 5 ms   |
| Temperature coefficient 0 to 18°C and 28 to 45°C |                    | $\pm$ (0.05 x Accuracy) /°C                                  |                             |  |  |
| Source function                                  |                    | DC, sweep (linear single, linear double, list), ARB (square) |                             |  |  |

**NOTES**

1. Supplemental characteristics
2. 10 Hz to 20 MHz: Supplemental characteristics
3. Open load

| Temperature measurement (Thermocouple)            |                   |  |              |
|---|-------------------|--|--------------|
| Temperature sensor                                | Range             | Accuracy $\pm$ (% + offset) <sup>1</sup> | Unit         |
| Type-K thermocouple                               | - 25 °C to 150 °C | 0.2% + 2 °C                              | °C, °F and K |
| Temperature probe in humidity sensor <sup>2</sup> | - 40 °C to 80 °C  | 0.5 °C                                   | °C, °F and K |

**NOTES**

1. Thermocouple accuracy excluded for thermocouple, temperature probe accuracy included for humidity sensor
2. Supported humidity sensor: EE07 Digital Humidity / Temperature Probe from E+E Elektronik

**Humidity measurement**

| Range            | Accuracy <sup>1</sup>   |
|------------------|---|
| 0 % to 100 %     | 2 % RH (0 % to 90 % RH)<br>3 % RH (90 % to 100 % RH)                          |
| Connector        | 2.5 mm pluggable terminal block, 5 pins (mating with Phoenix Contact 1881354) |
| Supported sensor | EE07 Digital Humidity / Temperature Probe from E+E Elektronik                 |

**NOTES**

1. Sensor accuracy included

**Measurement buffer and speed**

|                |         |
|----------------|---------|
| Reading buffer | 100,000 |
|----------------|---------|

**Supplemental characteristics**

## Measurement speed and performance

|  | Reading rates                 |                   |                   | Additional noise error |                     |
|--|-------------------------------|-------------------|-------------------|------------------------|---------------------|
|  | Integration time <sup>1</sup> | To buffer         | To GPIB           | Current Measurement    | Voltage Measurement |
|  | 100 PLC / 2 s                 | 0.5 Readings/s    | 0.5 Readings/s    | 0 % of range           | 0 % of range        |
|  | 10 PLC / 200 ms               | 5 Readings/s      | 5 Readings/s      | 0 % of range           | 0 % of range        |
|  | 1 PLC / 20 ms                 | 49 Readings/s     | 49 Readings/s     | 0.01% of range         | 0% of range         |
|  | 0.1 PLC / 2 ms                | 500 Readings/s    | 490 Readings/s    | 0.03% of range         | 0.0005% of range    |
|  | 0.01 PLC / 200 $\mu$ s        | 4,500 Readings/s  | 3,950 Readings/s  | 0.06% of range         | 0.001% of range     |
|  | 0.001 PLC / 20 $\mu$ s        | 20,000 Readings/s | 12,500 Readings/s | 0.1% of range          | 0.004% of range     |

**NOTES**

1. 50 Hz, fixed range

**Timer and trigger functions**

|                         |  |   |
|-------------------------|--|---|
| Timer                   | Time stamp                             | TIMER value automatically saved when each measurement is triggered. |
|                         | Resolution                             | 10 $\mu$ s, 100 $\mu$ s, 1 ms, 10 ms, 100 ms                        |
|                         | Min. Measurement Interval              | 10 $\mu$ s, independent from Source                                 |
|                         | Min. Source Interval                   | 100 $\mu$ s, independent from Measure                               |
|                         | Accuracy                               | $\pm$ 50 ppm  |
|                         | Arm/trigger delay                      | 0 $\mu$ s to 100,000 s  |
|                         | Arm/trigger interval                   | 10 $\mu$ s (Measure), 100 $\mu$ s (Source) to 100,000 s             |
|                         | Arm/trigger count                      | 1 to 100,000 counts or infinity                                     |
| Triggering <sup>1</sup> | Trigger in to trigger out              | $\leq$ 5 $\mu$ s  |
|                         | Trigger in to source change            | $\leq$ 200 $\mu$ s  |
|                         | Trigger in to measure                  | $\leq \pm$ 20 $\mu$ s   |
|                         | Internal event to external LXI trigger | Minimum 100 $\mu$ s, Typical 200 $\mu$ s, Maximum unknown           |
|                         | LXI event send/receive latency         | Unknown   |

**NOTES**

1. Supplemental characteristics

**Battery operation (B2983A, B2987A)**

|                  |  |
|------------------|--|
| Technology       | Li-ion battery with integrated smart battery monitor and charger |
| Capacity         | 14.40 V / 6,600 mAh / 95.0 Wh                                    |
| Battery exchange | Customer exchangeable  |

**Supplemental characteristics**

|                                     |   |
|-------------------------------------|---|
| Typical operating time <sup>1</sup> | 7 hours (B2983A), 5 hours (B2987A), 5 % to shutdown, auto data save                         |
| Recharging time                     | 7 hours to 100 % capacity (AC in, Power On), 3.5 hours to 100 % capacity (AC in, power Off) |
| Battery life                        | > 300 cycles with minimum 75 % of initial capacity @25 °C                                   |

**NOTES**1. Standalone, LCD on, input on, output off, auto triggered 2  $\mu$ A fixed range

| Measurement control / navigation |  |
|----------------------------------|--|
| Ranging                          | Automatic or manual  |
| Aperture time (integration time) | 10 $\mu$ s to 100 PLC  |
| Offset cancelling                | Null, Zero correct   |
| Digital filter                   | Median filter (2R + 1, R = 1 to 15), moving average (1 to 100, step 1)   |
| Math                             | Preset and user definable expressions  |
| Statistics                       | Histogram View mode: mean, sigma, # of bins and # of samples   |
| Line frequency detection         | Auto detect: 50 Hz or 60 Hz  |
| Measurement indicators           | "---" is displayed at no data captured, "OVERFLOW" is displayed over 105% of the range, "0 $\Omega$ " is displayed at current measurement overflow in Resistance measurement.            |
| Front panel operation            |  |
| Front panel interface            | 4.3" TFT color display (16,000,000 colors, 480 x 272 pixels) with keypads and rotary knob  |
| View mode                        | Meter view, Graph view, Histogram view and Roll view   |
| Hardkeys                         | Single Trigger and Run/Stop control, measurement navigation keys (Null, Filter, Math, Save and Recall), Rotary Knob and Cursors, Ammeter Input and V Source Output control, Cancel/Local |
| Softkeys                         | Function, System and Input Assist Keys   |
| Indicators                       | Channel (measurement) status, System status  |
| LEDs                             | Power (color changes when charging), Input and Output (color changes when high voltage sourcing), Battery status (B2983A, B2987A)  |
| Application softkey              | Setup Integrity Checker (optional), Data logger, Demo Slide Show, About B2987A   |

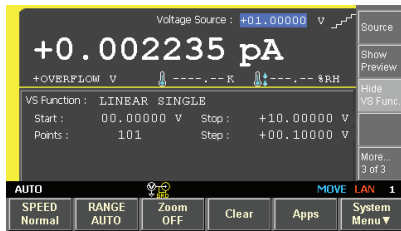

Meter View

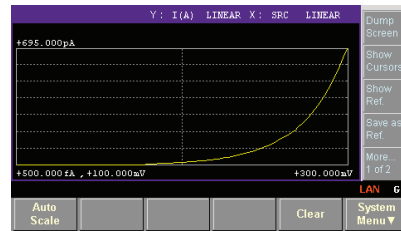

Graph View

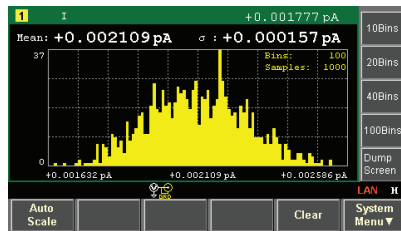

Histogram View

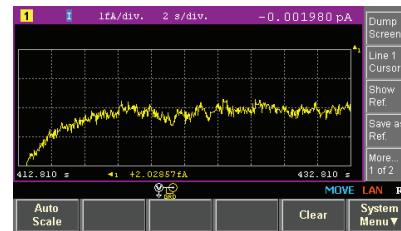

Roll View

| Input/Output specifications         |  |                             |
|-------------------------------------|--|-----------------------------|
| Meter input connector               | "Three lug triaxial for ammeter on rear panel (B2981A, B2983A)<br>Three lug triaxial for ammeter, and three lug triaxial for voltmeter on rear panel (B2985A, B2987A)" |                             |
| Guard                               | Switchable voltmeter guard available (B2985A, B2987A)  |                             |
| Maximum input                       | Ammeter: 30 mA, Voltmeter: 40 V  |                             |
| Source output connector             | Two banana jacks on rear panel   |                             |
| Maximum common mode voltage         | Meter common: 500 V peak: V Source 1,000 V peak  |                             |
| Isolation (Meter common to chassis) | > 10 G $\Omega$ , < 500 pF   |                             |
| Analog output                       | 2 V for full range input, non-inverting in voltage and current measurement modes, 1 k $\Omega$ output impedance  |                             |
| Interlock                           | 2.5 mm pluggable terminal block, 4 pin (mating with Phoenix Contact 1881341)   |                             |
| External trigger                    | Trigger input  | BNC                         |
|                                     | Logic  | Programmable edge triggered |
|                                     | Min pulse width  | 10 $\mu$ s                  |
|                                     | Trigger output   | BNC                         |
|                                     | Logic  | Programmable edge triggered |
|                                     | Min pulse width  | 10 $\mu$ s                  |

| Input/Output specifications   |  |  |
|-------------------------------|--|--|
| Digital I/O                   | Connector type   | DSUB female 9 pins   |
|                               | Input/output pins  | DIO 7 pins, +5V, GND   |
|                               | Absolute max input voltage   | 5.25 V   |
|                               | Absolute min input voltage   | - 0.25 V   |
|                               | Max logic L input voltage  | 0.8 V, Pull-up to 5 V by 5 k $\Omega$                              |
|                               | Min logic H input voltage  | 2.0 V, Pull-up to 5 V by 5 k $\Omega$                              |
|                               | Max source current   | 1 mA @ $V_o = 0$ V   |
|                               | Max sink current   | 50 mA @ $V_o = 5$ V  |
|                               | 5 V power supply pin   | Limited to 500 mA, resettable fuse protected                       |
| Computer interfaces           |  |  |
| LXI (Rev. 1.4)                | 10/100Base-T Ethernet (Sockets, VXI-11 protocol, HiSLIP, and Web user interface)                                       |  |
| USB                           | USB 2.0 (USB-TMC488 and MTP)<br>USB host controller on the front, USB device interface on the rear<br>Easy File Access |  |
| GP-IB                         | IEEE-488.2   |  |
| Program, software and drivers |  |  |
| Programming                   | SCPI   |  |
| Program memory                | 100 kB (1000 lines with 100 characters/line)   |  |
| LXI compliance                | LXI Core 2011  |  |
| Software available            | Quick I/V Measurement Software, Graphical Web Interface  |  |
| Drivers available             | IVI-C, IVI-COM drivers, LabVIEW drivers  |  |
| Environmental specifications  |  |  |
| Environment                   | For use in indoor facilities without air conditioning  |  |
| Operating                     | 0 °C to 45 °C (0 °C to 35 °C when charging battery), 30 % to 80 % non-condensing                                       |  |
| Storage                       | -20 °C to 60 °C, 10 % to 90 % non-condensing   |  |
| Altitude                      | Operating: 0 m to 2000 m, Storage: 0 m to 4600 m   |  |
| Power supply                  | 90 V to 264 V, 47 Hz to 63 Hz, 80 VA maximum   |  |
| EMC                           | IEC61326-1/EN61326-1, AS/NZS CISPR 11, KC: RRA Notification amending Radio Waves Act Article 58-2                      |  |
| Safety                        | IEC61010-1/EN61010-1, CAN/CSA-C22.2 No. 61010-1-12, C/US   |  |
| Certifications                | CE, cCSAus, RCM, KC  |  |
| Warm-up                       | 1 hour   |  |
| Dimensions                    | Case   | 88 mm (2U) x 213 mm (half width) x 348 mm                          |
|                               | Working  | 104 mm x 261 mm x 374 mm (with bumper)                             |
| Weight                        | Net  | 4.3 kg (B2981A), 4.9 kg (B2983A), 4.5 kg (B2985A), 5.1 kg (B2987A) |
|                               | Shipping   | 8.5 kg (B2981A), 9.0 kg (B2983A), 8.7 kg (B2985A), 9.2 kg (B2987A) |

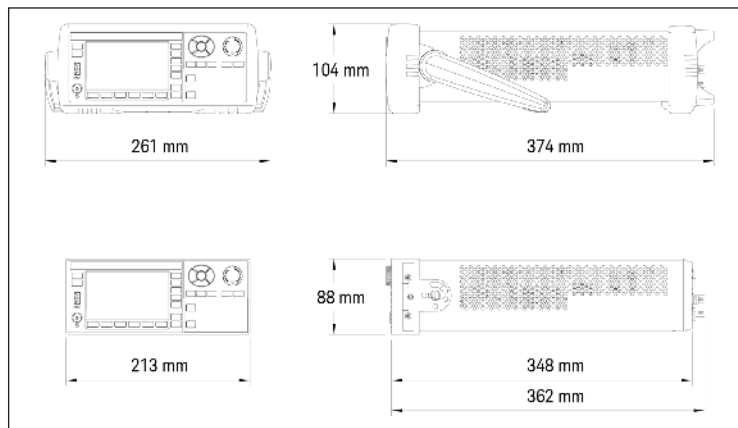

## Ordering information

| Model number       | Description  |
|--------------------|--|
| B2981A             | Femto/Picoammeter. 0.01 fA   |
| B2983A             | Femto/Picoammeter. 0.01 fA, Battery  |
| B2985A             | Electrometer/High Resistance Meter, 0.01 fA, 1000 V                                |
| B2987A             | Electrometer/High Resistance Meter, 0.01 fA, 1000 V, Battery                       |
| Options            |  |
| A6J                | ANSI Z540-1-1994 Calibration   |
| UK6                | Commercial Calibration Certificate with Test Data                                  |
| B2980A-1CM         | Rack Mount Kit   |
| Manuals            |  |
| N1403A-ABA         | User Guide English for B2980 Series  |
| N1403A-ABJ         | User Guide Japanese for B2980 Series   |
| Accessories        |  |
| N1411A             | Interlock cable, 4 pin terminal plug to 6 pin circular plug, 1.5 m                 |
| N1411B             | Interlock cable, 4 pin terminal plug to 6 pin circular plug, 3 m                   |
| N1413A             | High resistance meter fixture adapter  |
| N1414A             | High resistance measurement universal adapter                                      |
| N1415A             | Triax to alligator cable, 200 V, 1.5 m   |
| N1416A             | Triax bulkhead connector, 200 V  |
| N1417A             | Open cap for triaxial connector  |
| N1418A             | Lithium-ion battery pack for B2983/B2987   |
| N1419A             | Benchtop battery charger for N1418A  |
| N1423A             | Thermocouple for B2985/B2987   |
| 16494A-001/002/005 | Low leakage triax cable (1.5 m/3 m/4 m)  |
| N1254A-102         | Triax (female) to BNC (male) adaptor: For current measurement, Floating DUT/sample |
| N1254A-104         | Triax (female) to BNC (male) adaptor: For current measurement, Grounded DUT/sample |
| N1254A-105         | Triax (female) to BNC (male) adaptor: For voltage measurement                      |
| 16008B             | Resistivity cell   |
| Productivity tools |  |
| N1410A             | Starter kit for B2985/B2987  |
| N1420A             | Setup integrity checker for B2980 series, fixed perpetual license                  |
| N1422A             | High value resistor box for N1299A-301 evaluation kit                              |
| N1299A-301         | Evaluation kit for B2981/83/85/87A   |

**myKeysight**

myKeysight

[www.keysight.com/find/mykeysight](http://www.keysight.com/find/mykeysight)

A personalized view into the information most relevant to you.



[www.lxistandard.org](http://www.lxistandard.org)

LAN eXtensions for Instruments puts the power of Ethernet and the Web inside your test systems. Keysight is a founding member of the LXI consortium.



**Three-Year Warranty**

[www.keysight.com/find/ThreeYearWarranty](http://www.keysight.com/find/ThreeYearWarranty)

Keysight's commitment to superior product quality and lower total cost of ownership. The only test and measurement company with three-year warranty standard on all instruments, worldwide.



**Keysight Assurance Plans**

[www.keysight.com/find/AssurancePlans](http://www.keysight.com/find/AssurancePlans)

Up to five years of protection and no budgetary surprises to ensure your instruments are operating to specification so you can rely on accurate measurements.



[www.keysight.com/quality](http://www.keysight.com/quality)

Keysight Technologies, Inc.  
DEKRA Certified ISO 9001:2008  
Quality Management System

**Keysight Channel Partners**

[www.keysight.com/find/channelpartners](http://www.keysight.com/find/channelpartners)

Get the best of both worlds: Keysight's measurement expertise and product breadth, combined with channel partner convenience.

[www.keysight.com/find/b2980a](http://www.keysight.com/find/b2980a)



**B2900A Precision Source/Measure Unit**

[www.keysight.com/find/precisionSMU](http://www.keysight.com/find/precisionSMU)



**B2960A Low Noise Power Source**

[www.keysight.com/find/precisionSOURCE](http://www.keysight.com/find/precisionSOURCE)



**B1500A Semiconductor Device Analyzer**

[www.keysight.com/find/b1500a](http://www.keysight.com/find/b1500a)

For more information on Keysight Technologies' products, applications or services, please contact your local Keysight office. The complete list is available at: [www.keysight.com/find/contactus](http://www.keysight.com/find/contactus)

**Americas**

|               |                  |
|---------------|------------------|
| Canada        | (877) 894 4414   |
| Brazil        | 55 11 3351 7010  |
| Mexico        | 001 800 254 2440 |
| United States | (800) 829 4444   |

**Asia Pacific**

|                    |                |
|--------------------|----------------|
| Australia          | 1 800 629 485  |
| China              | 800 810 0189   |
| Hong Kong          | 800 938 693    |
| India              | 1 800 112 929  |
| Japan              | 0120 (421) 345 |
| Korea              | 080 769 0800   |
| Malaysia           | 1 800 888 848  |
| Singapore          | 1 800 375 8100 |
| Taiwan             | 0800 047 866   |
| Other AP Countries | (65) 6375 8100 |

**Europe & Middle East**

|                |               |
|----------------|---------------|
| Austria        | 0800 001122   |
| Belgium        | 0800 58580    |
| Finland        | 0800 523252   |
| France         | 0805 980333   |
| Germany        | 0800 6270999  |
| Ireland        | 1800 832700   |
| Israel         | 1 809 343051  |
| Italy          | 800 599100    |
| Luxembourg     | +32 800 58580 |
| Netherlands    | 0800 0233200  |
| Russia         | 8800 5009286  |
| Spain          | 0800 000154   |
| Sweden         | 0200 882255   |
| Switzerland    | 0800 805353   |
|                | Opt. 1 (DE)   |
|                | Opt. 2 (FR)   |
|                | Opt. 3 (IT)   |
| United Kingdom | 0800 0260637  |

For other unlisted countries:  
[www.keysight.com/find/contactus](http://www.keysight.com/find/contactus)  
(BP-07-10-14)

