

Digital Display (80/120/200 mm) M7E

CSM_M7E(80_120_200mm)_DS_E_10_1

Digital Display with Wire-saving Serial Transmission Function (B7A Output)



- Single-color (red or green) and three-color (red, green, or orange selectable) displays with a character height of 80, 120, or 200 mm are available for a variety of applications and locations.
- Thin design with a 39.5-mm depth for the 120-mm model is perfect for saving space in equipment and devices.
- Decimal display including negative sign (–) display with signal codes is possible.







Ordering Information

List of Models



Models with 80 mm-high Characters

Display contents	Type	Logic input	Display color	Model
Decimal	Front mounting 	Negative	Red	M7E-08DRN2
			Green	M7E-08DGN2
Hexadecimal	Front mounting 	Negative	Red	M7E-08HRN2
			Green	M7E-08HGN2

Models with 120 mm-high Characters

Display contents	Type	Logic input	Display color	Model
Decimal	Rear mounting 	Negative	Red	M7E-12DRN1
			Green	M7E-12DGN1
			Red/green/orange	M7E-12DKN1
	Front mounting 		Red	M7E-12DRN2
			Green	M7E-12DGN2
			Red/green/orange	M7E-12DKN2
Hexadecimal	Rear mounting 	Negative	Red	M7E-12HRN1
			Green	M7E-12HGN1
			Red/green/orange	M7E-12HKN1
	Front mounting 		Red	M7E-12HRN2
			Green	M7E-12HGN2
			Red/green/orange	M7E-12HKN2

Models with 200 mm-high Characters

Display contents	Type	Logic input	Display color	Model
Decimal	Rear mounting 	Negative	Red	M7E-20DRN1
			Green	M7E-20DGN1
			Red/green/orange	M7E-20DKN1
Rear mounting 	Red		M7E-20HRN1	
	Green		M7E-20HGN1	
	Red/green/orange		M7E-20HKN1	

Connectable PLCs

M7E model		PLC's output method	
Display	Logic input	Static output	
		PNP output	NPN output
Decimal	Negative	Not connectable	Connectable
Hexadecimal	Negative	Not connectable	Connectable

Accessories (Order Separately)

Harness Connector

Dimensions	Model
70 mm	M7E-WH0111A
500 mm	M7E-WH0511A
1,000 mm	M7E-WH1011A

Specifications

Ratings

Rated power supply	24 VDC
Allowable voltage fluctuation range	90% to 110% of rated voltage
Current consumption (per display)	M7E-08 (at 24 VDC) Red LED: 120 mA max. Green LED: 160 mA max.
	M7E-12 (at 24 VDC) Red LED: 200 mA max. Green LED: 330 mA max. Red/Green LED (orange: lit): 330 mA max.
	M7E-20 (at 24 VDC) Red LED: 420 mA max. Green LED: 500 mA max. Red/Green LED (orange: lit): 500 mA max.
Input level	Negative logic: High: 4 V to power supply voltage Low: 0 to 1.5 V
	Standard logic: High: 4 V to power supply voltage Low: 0 to 1.5 V
Ambient temperature	Operating: –10 to 55°C (with no icing) Storage: –25 to 70°C (with no icing)
Ambient humidity	Operating: 35% to 85% (with no condensation)

Characteristics

Insulation resistance	100 MΩ min. (at 500 VDC) between each terminal and mounting panel
Dielectric strength	500 VAC, 50/60 Hz for 1 min between each terminal and mounting panel
Noise immunity (See note.)	Power terminal: ±500 V Input terminals: ±500 V (normal mode) ±1,500 V (common mode)
Vibration resistance	Destruction: 10 to 55 Hz, 0.75-mm double amplitude
Shock resistance	Destruction: 300 m/s ²
Degree of protection	IEC IP40 (portion on panel surface)

- Note: 1. Initial values
2. Impulse conditions:
Rise time: 1 ns +10% max.
Pulse width: 100 ns, 1 μs
Polarity: Positive, negative, asynchronous to power frequency, 100 Hz repeat frequency.

Installation

■ Cables

Refer to *M7E Options* for information on using cables (OMRON G79-□C, G79-Y□C, and G79-O□C-□).

■ M7E-WH□11A Harness Connector

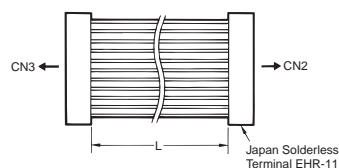

ℓ	Model
70 mm	M7E-WH011A
500 mm	M7E-WH0511A
1,000 mm	M7E-WH1011A

■ Input Codes

Negative Logic Standard Unit

Connector pin No. (CN1)	Input signal								Output display condition		
	①	④	⑤	⑫	⑪	⑤	⑥			Decimal	Hexadecimal
Terminal symbol	LE	D	C	B	A	DP	BI	RBI	RBO		
Input signals	H	H	H	H	H	H	H	L	L	Blank	Blank
	H	H	H	H	H	H	H	H	H	0	0
	H	H	H	H	H	L	H	*	H	0.	0.
	H	H	H	H	L	H	H	*	H	1	1
	H	H	H	L	L	H	H	*	H	2	2
	H	H	H	L	L	H	H	*	H	3	3
	H	H	L	H	H	H	H	*	H	4	4
	H	H	L	H	L	H	H	*	H	5	5
	H	H	L	L	H	H	H	*	H	6	6
	H	H	L	L	L	H	H	*	H	7	7
	H	L	H	H	H	H	H	*	H	8	8
	H	L	H	L	H	H	H	*	H	9	9
	H	L	H	L	H	H	H	*	H	-	A
	H	L	H	L	L	H	H	*	H	Blank (See note 1.)	b
	H	L	L	H	H	H	H	*	H	DP lights at serial input. (See note 2.)	c
	H	L	L	H	L	H	H	*	H	DP lights at serial input. (See note 3.)	d
	H	L	L	L	H	H	H	*	H	Blank (See note 1.)	E
H	L	L	L	L	H	H	*	H	Blank (See note 1.)	F	
*	*	*	*	*	L	H	*	H	.	.	
*	*	*	*	*	*	L	*	H	Blank (See note 1.)	Blank (See note 1.)	
L	*	*	*	*	*	*	H	*	H	(See note 4.)	(See note 4.)

* Either low or high. All inputs are pulled up internally. Therefore high can be open.

- Note:**
1. Only the numeral will be OFF. (There is no relationship to the decimal point.)
 2. Only the numeral will be OFF if there is parallel input with CN1. The decimal point will be lit if there is B7A serial input with TB1.
 3. Only the numeral will be OFF if there is parallel input with CN1. The decimal point will be OFF if there is B7A serial input with TB1.
 4. The previous statuses of A to D before LE goes low will be held. There is no relationship to the decimal point. The LE latch function will not, however, operate at the time of serial transmission.

Terminal Arrangement/Functions

1. Input Terminal

TB1

Terminal symbol	Name	Function
+V	Power supply	Positive (+) power-supply terminal.
GND	Power supply	0 V power-supply terminal.
SI	Serial data input	B7A serial data received

CN1 (XG4A-2034)

Terminal No.	XG4-2034 pin No.	Terminal symbol	Name	Function
1	(20)	LE1	Control input	1st-digit latch input: The previous display is held when this signal is input.
2	(18)	LE2	Control input	2nd-digit latch input: The previous display is held when this signal is input.
3	(16)	LE3	Control input	3rd-digit latch input: The previous display is held when this signal is input.
4	(14)	LE4	Control input	4th-digit latch input: The previous display is held when this signal is input.
5	(12)	DP	Data input	The decimal point lights. Operates independently of the LE signal.
6	(10)	BI	Control input	Blank input: Turns OFF all the displays.
7	(8)	R	Control input	Color selector input: Red is lit when low is input (See note.)
8	(6)	G	Control input	Color selector input: Green is lit when low is input (See note.)
9	(4)	GND	Power supply	0 V power-supply terminal. (Terminals 9 and 19 are connected internally.)
10	(2)	+V	Power supply	Positive side (+) power-supply terminal. (Terminals 10 and 20 are connected internally.)
11	(19)	A	Data input	The value and symbol corresponding to the input code signal are displayed. Refer to the list of input codes for the contents of display.
12	(17)	B	Data input	
13	(15)	C	Data input	
14	(13)	D	Data input	
15	(11)	NC	Open	---
16	(9)	NC	Open	---
17	(7)	NC	Open	---
18	(5)	NC	Open	---
19	(3)	GND	Power supply	0 V power-supply terminal. (Terminals 9 and 19 are connected internally.)
20	(1)	+V	Power supply	Positive side (+) power-supply terminal. (Terminals 10 and 20 are connected internally.)

Note: If the R and G of the multi-color display are set low, the Unit will display in orange.

Terminal Arrangement

Models with 120/200-mm-high Characters

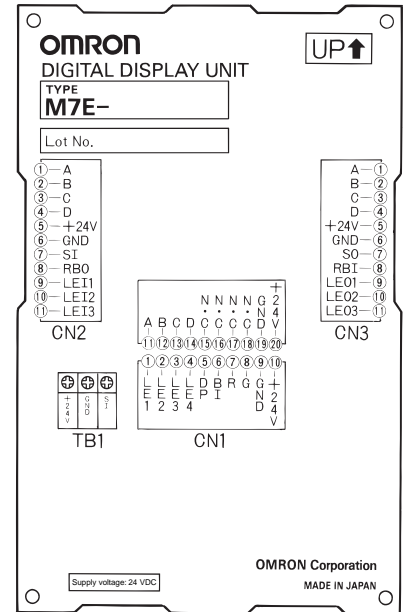

2. Multi-digit Connection Terminals

CN2, CN3

Terminal No.	CN2 (IN)			CN3 (OUT)		
	Symbol	Name	Function	Symbol	Name	Function
1	A	Data input	A (2 ⁰)	A	Data output	A (2 ⁰)
2	B	Data input	B (2 ¹)	B	Data output	B (2 ¹)
3	C	Data input	C (2 ²)	C	Data output	C (2 ²)
4	D	Data input	D (2 ³)	D	Data output	D (2 ³)
5	+V	Power supply	Positive side (+) power-supply terminal	+V	Power supply	Positive side (+) power-supply terminal
6	GND	Power supply	0 V power-supply terminal	GND	Power supply	0 V power-supply terminal
7	SI	Control input	B7A serial data received	SO	Control output	B7A serial data transmitted
8	RBO	Control output	Zero-suppress output (See note 3.)	RBI	Control input	Zero-suppress input (See note 3.)
9	LE11	Control input	1st-digit latch input	LEO1	Control output	2nd-digit latch output
10	LE12	Control input	2nd-digit latch input	LEO2	Control output	3rd-digit latch output
11	LE13	Control input	3rd-digit latch input	LEO3	Control output	4th-digit latch output

- Note: 1.** The CN2 or CN3 Multi-digit Connector must be used for serial transmission and dynamic control with the B7A Link Terminal. Refer to page 5 for details. To use zero suppression, refer to page 8. Use the CN2 and CN3 for connection with the M7E only.
- 2.** Use the following connectors for the connector terminals:
 CN1: XG4M-2030 or equivalent
 CN2 and CN3: M7E-WH□11A
 Refer to *CN1 Terminal Arrangement* for the pin numbers.
 Refer to page 2 for the dedicated harness.
- 3.** Refer to the list of input codes for RBO or RBI control.

CN1 Terminal Arrangement

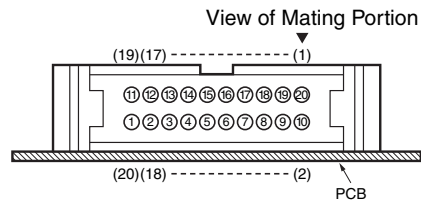

- Note: 1.** The numbers in parentheses are the pin numbers for the XG4C-2031 Connector for Models with 80-mm-high Characters and for the XG4A-2034 Connector for Models with 120/200-mm-high Characters.
- 2. Connectors**
- Flat-cable Connector: XG4M-2030
 - Connectors for Loose Wires with Crimp Terminals: XG5M-2032-N (Applicable wire gauge: AWG24) XG5M-2035-N (Applicable wire gauge: AWG28 to AWG26)

Models with 80 mm-high Characters

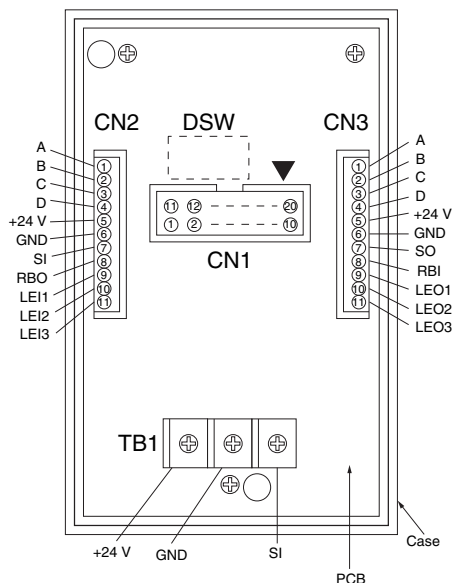

Block Diagram

Note: Circled numbers are the connector pin numbers.

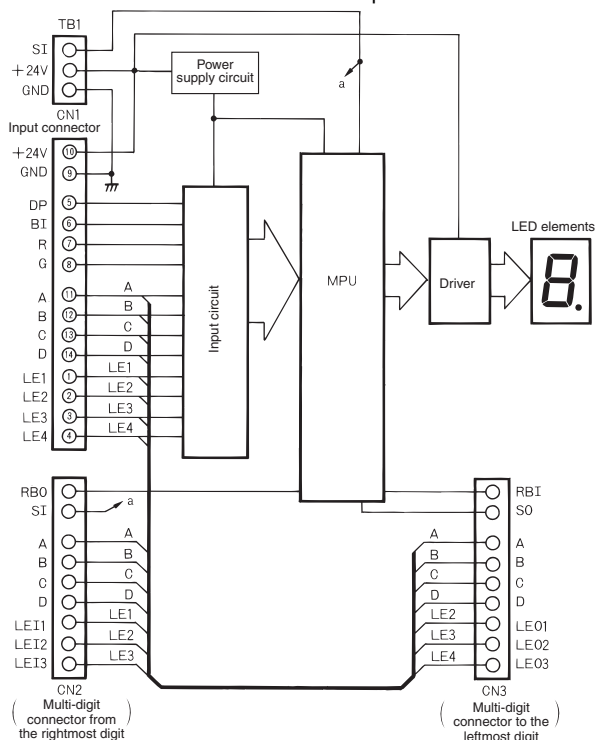

Signal Input Circuit

Negative Logic Model

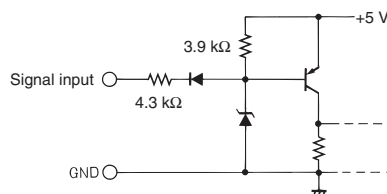

Operation Examples of Zero Suppression

Zero suppression operates when the display is 0, RBI is low, and the decimal point is not lit. Then low is output to RBO.

Example 1: Zero suppression is not required and the RBI input and RBO output of each digit are open.

Example 2: Zeros are suppressed only for the digits on the left of the digit where the decimal is lit when both zero suppression and a decimal point are being used.

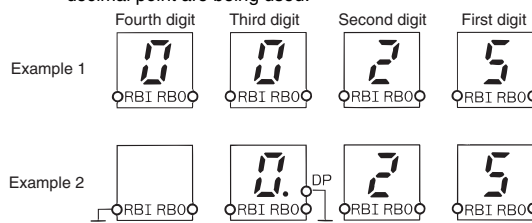

Note: Use RBO output for the connection with RBI input only.

External Connections

Refer to *Block Diagram* on page 4 and *Terminal Arrangement/Functions* on page 3 for external connections for each Unit.

PLC Connections

Refer to your PLC operation manual before connecting the PLC.

Static Control

Connected to C500-OD213 Transistor Output Unit

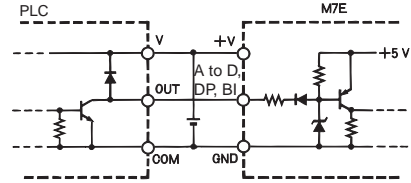
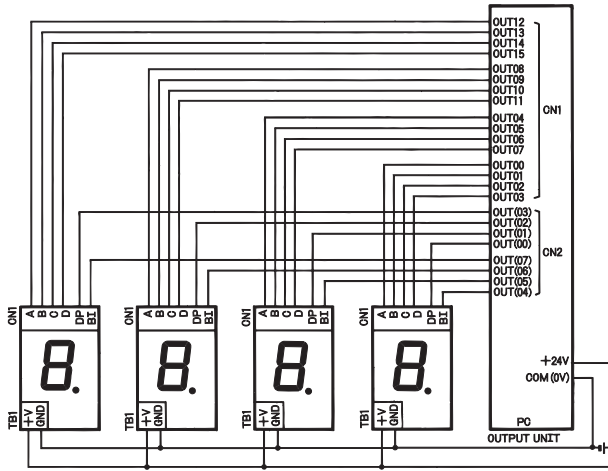

Connect the PLC's output to the A to D (BCD output), DP, and BI terminals individually.

Note: Use separate output terminals for DP or BI control.

Dynamic Control

Connected to C200H-OD215 (Static Mode) Transistor Output Unit

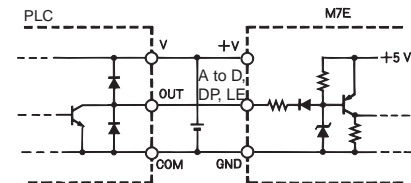
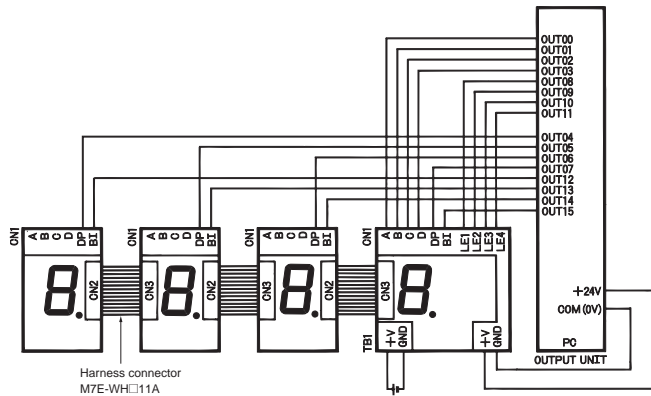

- Connect the PLC's output to the A to D (BCD output) terminals of the rightmost digit.
- Latch control is set with the LE1 to LE4 terminals of the rightmost Unit.
The terminals correspond as follows:
LE1: Rightmost digit (example: 1's digit)
LE2: Second digit (example: 10's digit)
LE3: Third digit (example: 100's digit)
LE4: Fourth digit (example: 1,000's digit)

- Note:**
1. The display colors of the three-color displays must be selected individually.
 2. In static mode, ladder programming is required for latch control.

B7A Link Terminal

Connected to C500-OD219 Transistor Output Unit

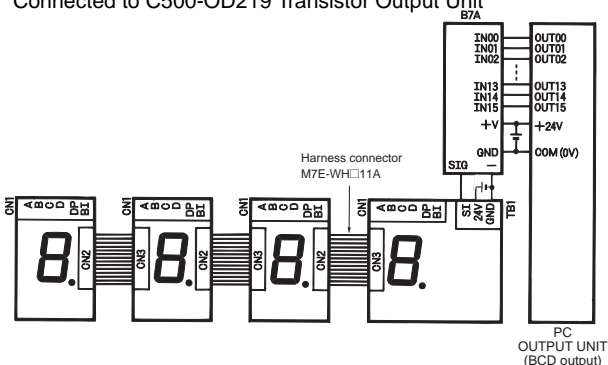

- By supplying power to a single display, all the displays will be supplied with power.
- The B7A's serial output must be connected to the SI terminal of the rightmost TB1.
- Use OMRON's M7E-WH□11A Harness Connectors or equivalent to connect all Units.
- The DP and BI terminals can be controlled by transmitting the following special data
Hexadecimal C data: Turns ON the decimal point of the relevant digit.
Hexadecimal D data: Turns OFF the decimal point of the relevant digit.
Hexadecimal F data: Deletes the display (BI control) of the relevant digit.
- Use the B7A Link Terminal with a normal I/O delay of 19.2 ms. The B7A with short I/O delay cannot be used.

Note: The display colors of the three-color displays must be selected individually.

Serial Transmission with B7A Link Terminal

A series of models incorporating a communications (serial transmission) function is available.

By using the B7A Link Terminal (PLC connector model), the Units can be connected to the PLC with ease. The 16-point B7A Link Terminal allows the control of a maximum of four digits over two wires.

Power Supplies Placed on Both the Transmitting and Receiving Sides

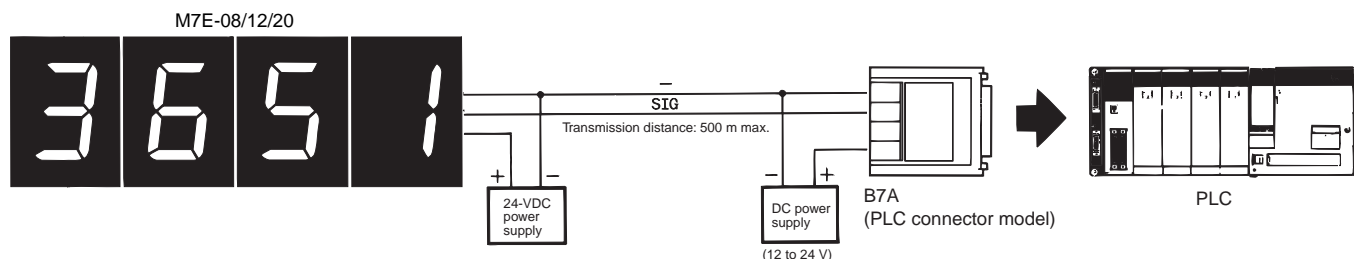

Power Supply Placed Only on the Receiving Side

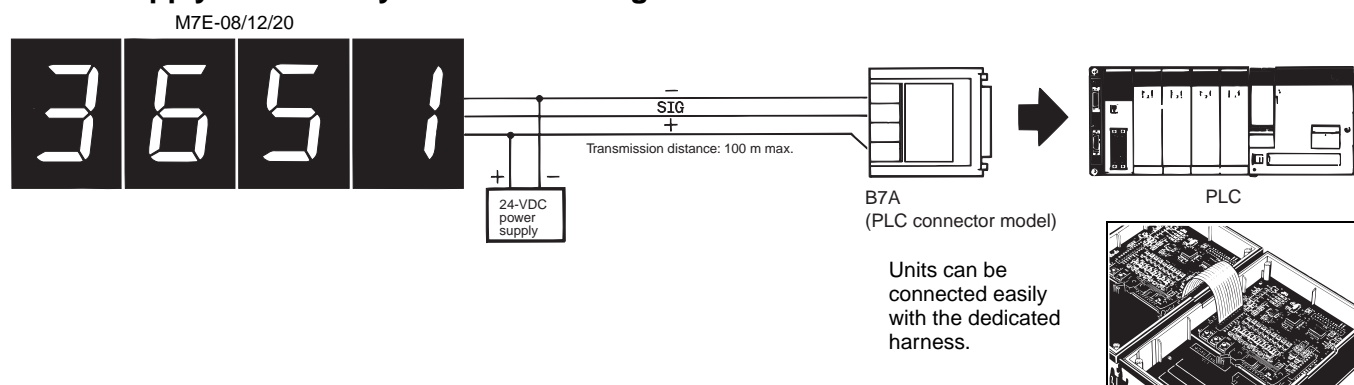

Available Link Terminal Models

Transmission side	Wiring	No. of I/O points	Connectable M7E Display Units
B7A-T10S1	Screw terminal model	10	2
B7A-T10S3	Screw terminal model	10	2
B7A-T10M2	Module model	10	2
B7A-T6A1	Screw terminal model	16	4
B7A-T6B1	Screw terminal model	16	4
B7A-T6C1	Screw terminal model	16	4
B7A-T6D2	Module model	16	4
B7A-T6E3	Connector model	16	4
B7A-T3E3 (See note 2.)	Connector model	32	8
C200H-B7A (See note 3.)	Screw terminal model	16 × □ ports	4 × □ ports
QCM1-B7A (See note 3.)	Screw terminal model	16 × □ ports	4 × □ ports
CJ1W-B7A (See note 3.)	Screw terminal model	16 × □ ports	4 × □ ports
CS1W-B7A (See note 3.)	Screw terminal model	16 × □ ports	4 × □ ports

- Note: 1.** Use the B7A Link Terminal with a normal I/O delay of 19.2 ms. The B7A with short I/O delay cannot be used.
- 2.** The connection of the 32-point connector model is as follows:

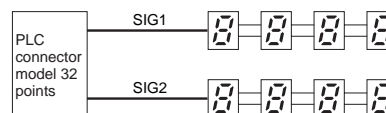

- 3.** For details on corresponding models, refer to each applicable model's catalog.

Transmission Path

Transmission distance:

A maximum transmission distance of 500 m is possible by using the VCTF 0.75 x 2C Cable if power is supplied independently to the Input and Output Link Terminals.

A maximum transmission distance of 100 m is possible by using the VCTF 0.75 x 3C Cable if a single power supply is connected to the Input or Output Link Terminal, in which case the current flow on the power lines (positive and negative lines) is 1.8 A maximum.

Transmission delay:

A maximum of 50 ms for data display after the B7A's input signal becomes definite.

Minimum Input Time

Use an input time of 80 ms min. to the Input Unit for the B7A.

Signal Allocation

B7A-M7E Corresponding Pin List

The B7A's switch terminals correspond to the M7E's parallel input signals as follows:

B7A switch terminal	M7E parallel input
A0 A1 A2 A3	First digit (1's digit) A B C D
A4 A5 A6 A7	Second digit (10's digit) A B C D
A8 A9 A10 A11	Third digit (100's digit) A B C D
A12 A13 A14 A15	Fourth digit (1000's digit) A B C D

Note: A maximum of two Display Units can be connected when the 10-point B7A Link Terminal is used and a maximum of four Display Units can be connected when the 16-point B7A Link Terminal is used.

Errors

- No signal transmission is available due to the disconnection of the transmission path (the SI or GND wire).
- The waveform is greatly distorted due to external noise interference or because the transmission path is longer than the permissible transmission path.

Error Indication

When an error results, "-" will be displayed and the display will flash. After the condition returns to normal, reception data will be displayed.

Display after Error Correction

After the condition returns to normal, the display will be reset automatically and reception data will be displayed.

Serial Transmission Control Examples

1. 1234 is displayed.

Note: The transmission data is hexadecimal.

Transmission data → Display

1	2	3	4
---	---	---	---

1234

2. -123 is displayed.

Transmission data → Display

-	1	2	3
---	---	---	---

A123

3. 12.34 is displayed.

Transmission data → Display

-	1.	2	3
---	----	---	---

 (The decimal point is controlled first.)
DCDD

Transmission data → Display

1	2.	3	4
---	----	---	---

 (Numeral data is transmitted next.)
1234

4. 9.876 is displayed.

Transmission data → Display

1	2.	3	4
---	----	---	---

 (The decimal point is controlled first.)
CDDD

Transmission data → Display

9.	8	7	6
----	---	---	---

 (Numeral data is transmitted next.)
9876

5. 4.2-1 is displayed.

Transmission data → Display

4.	2	-	1
----	---	---	---

 (Numeral setting is possible.)
42A1

6. The displayed decimal point will be OFF.

Transmission data → Display

4	2	-	1
---	---	---	---

DDDD

7. Changing the numeral and decimal point simultaneously. (It is, however, impossible to change the numeral and decimal point on the same digit simultaneously.)

Transmission data → Display

4	3	1	1
---	---	---	---

C311

8. Turn OFF the display by sending data F.

Transmission data → Display

4	3	1	4
---	---	---	---

 (The decimal point is OFF.)
DDDD

Transmission data → Display

3	2		1
---	---	--	---

 (Display turns OFF with F transmission.)
32F1

Note: DP and BI control using serial transmission is not displayed in hexadecimal.

A Variety of Control Operations with Short-circuit Sockets

By removing the rear cover of the Display Unit and setting the XJ8A-0211 Short-circuit Socket, the following control operations are possible.

1. DP (J5) - - - - Decimal Control

- Short-circuit the DP (J5) terminals with a short-circuit socket so that the decimal point will be always lit.
- The short-circuit socket is short-circuited at the factory (i.e., normally lit). Open the short-circuit socket if external control or lighting are not required

2. RBI (J9) } - - - Zero Suppression Control
TER (J11)

- When the zero suppression function is not used, the RBI (J9) terminals must be open. The TER (J11) terminals can be either short-circuited or open.
- When zero suppression is not used, the RBI (J9) terminals of the M7E Digital Display Unit for the leftmost digit must be short-circuited, those of all the other M7E Digital Display Units must be open, the TER (J11) terminals of the M7E Digital Display Unit for the rightmost digit must be open, and those of all the other M7E Digital Display Units must be short-circuited.

Example of Zero Suppression Setting for Four Digits on the M7E (120/200-mm Model)

Note: To use zero suppression, CN2 and CN3 must be connected with an M7E-WH□11A Harness Connector. In static mode, ladder programming is required for latch control. If latch control is not used, cut the data I/O lines (pins 1 to 4) on the Harness Connector.

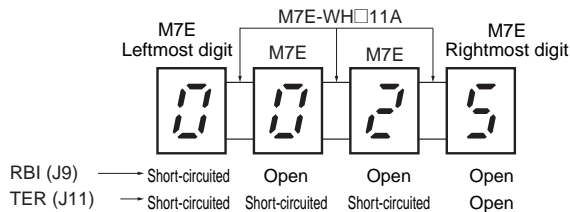

Example of Zero Suppression Setting for Four Digits on the M7E (80-mm Model)

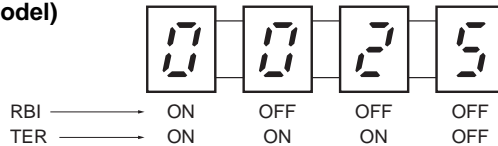

3. R (J8) } - - - Display Color Control (Three-color Model Only)
G (J10)

- Short-circuit the R (J8) terminals with a short-circuit socket so that the display will be lit in red.
- Short-circuit the G (J10) terminals with a short-circuit socket so that the display will be lit in green.
- Short-circuit the R (J8) as well as G (J10) terminals with two short-circuit sockets so that the display will be lit in orange.

Note: When the R (J8) as well as G (J10) terminals are open, the display will be OFF if the CN1 Input Connector has not been connected yet.

Note: 1. All the terminals are short-circuited before shipping. Short-circuit or open the terminals according to the application.

- Single-color (red or green) models do not incorporate the R (J8) and G (J10) terminals.
- These terminals must be open when controlling the DP (J5), R (J8), and G (J10) terminals externally by inputting signals from the CN1. (The short-circuit socket will take precedence.)
- All the terminals J5 to J11 are connected to GND.
- The 80-mm Model uses DIP switches. ON: Short-circuited OFF: Open (SEL1 and SEL2 are switches to adjust brightness.)

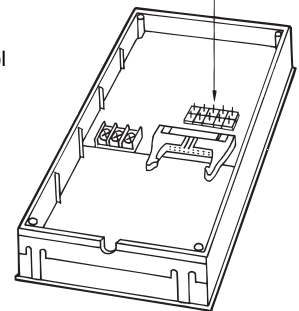
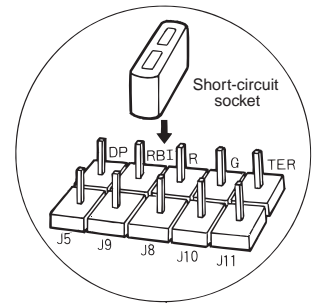

80-mm Model

DIP Switch

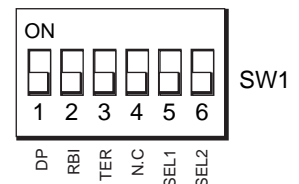

- Pins 1 to 4 are all factory-set to OFF.
- Pins 5 and 6 are factory-set for brightness adjustment. Do not change the setting of these pins; the brightness will change.

Zero Suppression

To use zero suppression, first connect the CN3 and CN2 connectors on the M7E to the M7E-WH□11A Harness Connector. Then, set the DIP switch on the M7E-08□ (80-mm model) or short the required pins with short-circuit sockets on the M7E-12□ (80-mm model) or M7E-20□(200-mm model).

Zero Suppression for 80-mm Models

To use zero suppression, turn ON the RBI and TER pins on the DIP switch on the M7E for the most-significant digit, turn OFF the RBI and TER pins on the DIP switch on the M7E for the least-significant digit, and then turn the RBI pin OFF and the TER pin ON on the DIP switches on the M7E for the other digits.

DIP Switch

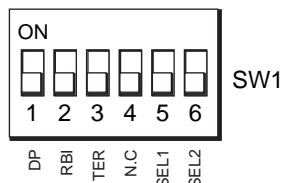

- Pins 1 to 4 are all factory-set to OFF.
- Pins 5 and 6 are factory-set for brightness adjustment. Do not change the setting of these pins; the brightness will change.

To use zero suppression, CN2 and CN3 must be connected with the M7E-WH□11A Harness Connector.

In static mode, ladder programming is required for latch control. If latch control is not used, cut the data I/O lines (pins 1 to 4) on the Harness Connector.

Example of Zero Suppression Setting for Four Digits on the M7E (80-mm Model)

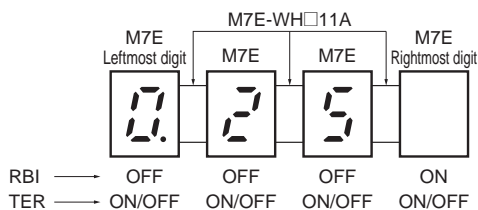
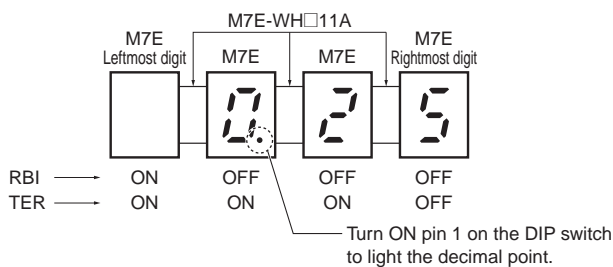
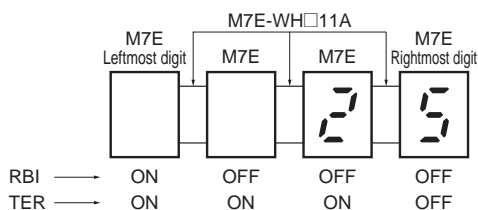
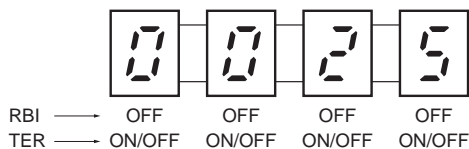

Zero Suppression for 120/200-mm Models

To use zero suppression, short-circuit the RBI and TER pins with the short-circuit sockets on the M7E for the most-significant digit, and leave these pins open on the M7E for the least-significant digit. For the M7E for other digits, leave the RBI pin open and short-circuit the TER pin.

By removing the rear cover of the Display Unit and setting the XJ8A-0211 Short-circuit Socket, the following control operations are possible.

To use zero suppression, CN2 and CN3 must be connected with the M7E-WH□11A Harness Connector.

In static mode, ladder programming is required for latch control. If latch control is not used, cut the data I/O lines (pins 1 to 4) on the Harness Connector.

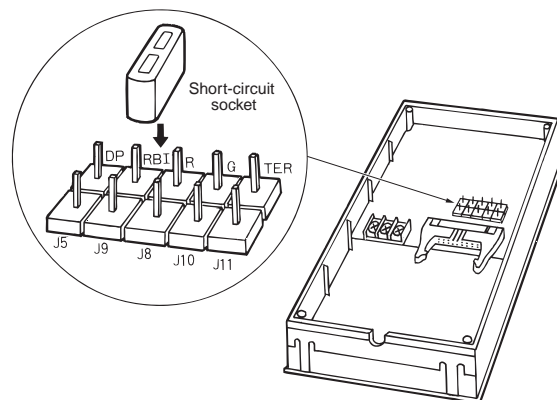

1. DP (J5) ----- Decimal Control
 - Short-circuit the DP (J5) terminals with a short-circuit socket so that the decimal point will be always lit.
 - The short-circuit socket is short-circuited at the factory (i.e., normally lit). Open the short-circuit socket if external control or lighting are not required.
2. RBI (J9) } ----- Zero Suppression Control
 TER (J11) }
 - When the zero suppression function is not used, the RBI (J9) terminals must be open. The TER (J11) terminals can be either short-circuited or open.
 - When zero suppression is not used, the RBI (J9) terminals of the M7E Digital Display Unit for the leftmost digit must be short-circuited, those of all the other M7E Digital Display Units must be open, the TER (J11) terminals of the M7E Digital Display Unit for the rightmost digit must be open, and those of all the other M7E Digital Display Units must be short-circuited.

- Note:**
1. All the terminals are short-circuited before shipping. Short-circuit or open the terminals according to the application.
 2. Single-color (red or green) models do not incorporate the R (J8) and G (J10) terminals.
 3. These terminals must be open when controlling the DP (J5), R (J8), and G (J10) terminals externally by inputting signals from the CN1. (The short-circuit socket will take precedence.)
 4. All the terminals J5 to J11 are connected to GND.

Example of Zero Suppression Setting for Four Digits on the M7E (120/200-mm Model)

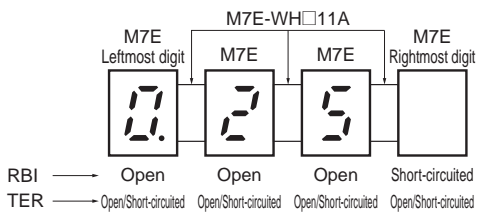
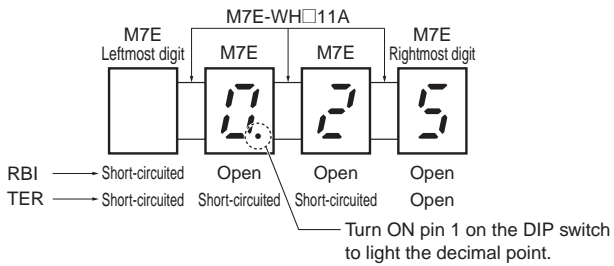
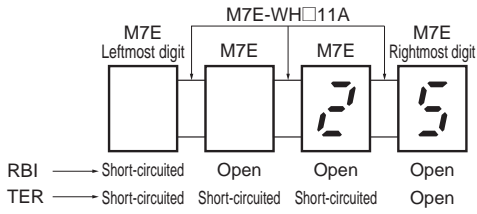
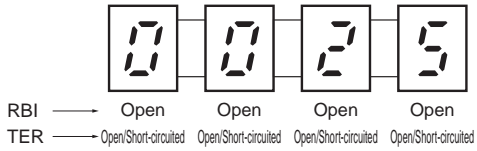

Operation

■ Operation Timing (Input Signal Timing)

Negative Logic

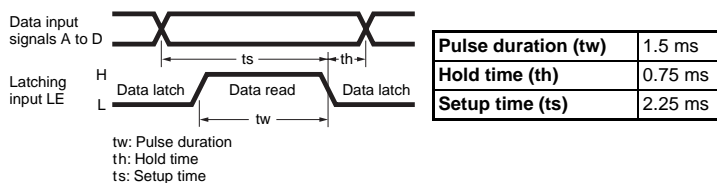

■ Operation Chart

The following example shows the relationship between each input terminal and the display condition.

Data		0	1	2	3	4	5	6	7	8	9	Description		
Input signals	A (2 ⁰)	H	L	H	L	H	L	H	L	H	L	Inputs the data signal as BCD (or binary code).		
	B (2 ¹)	H	H	L	L	H	H	L	L	H	H			
	C (2 ²)	H	H	H	H	L	L	L	L	H	H			
	D (2 ³)	H	H	H	H	H	H	H	H	L	L			
	DP	H	H	H	H	L	L	L	L	H	H		Low when the decimal point lights. The decimal point can light without regard to the LE signal.	
	BI	H	H	H	H	H	H	H	H	L	L		H	Low when the display is turned OFF.
	LE	H	L	L	L	H	H	L	L	H	H		L	Low when the display is to be retained. (High is retained until the signal goes low.)
Display condition												---		
Remarks	The "1" display is retained by the LE signal.			The "5" display is retained by the LE signal.			The display turned OFF by the BI signal (no display).					---		

Dimensions

Note: All units are in millimeters unless otherwise indicated.

M7E-08□□N2

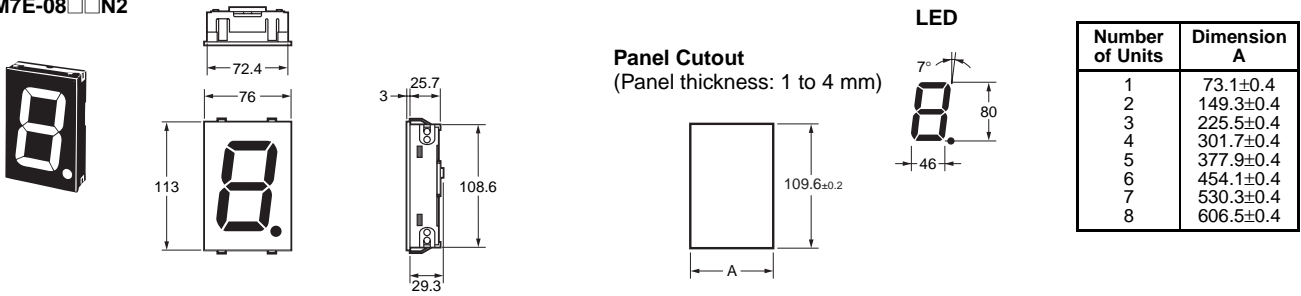

M7E-12□□N2

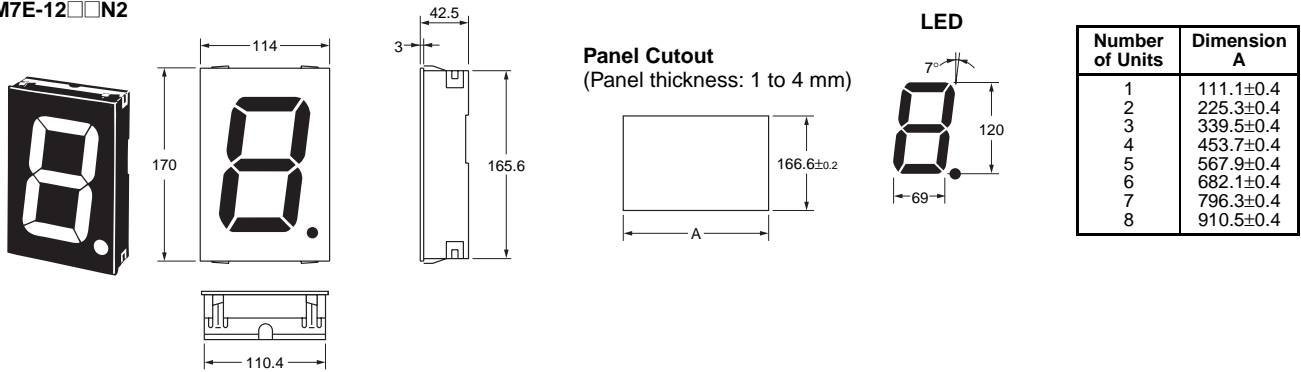

Note: Tolerance is ±0.4 mm unless otherwise specified.

M7E-12□□N1

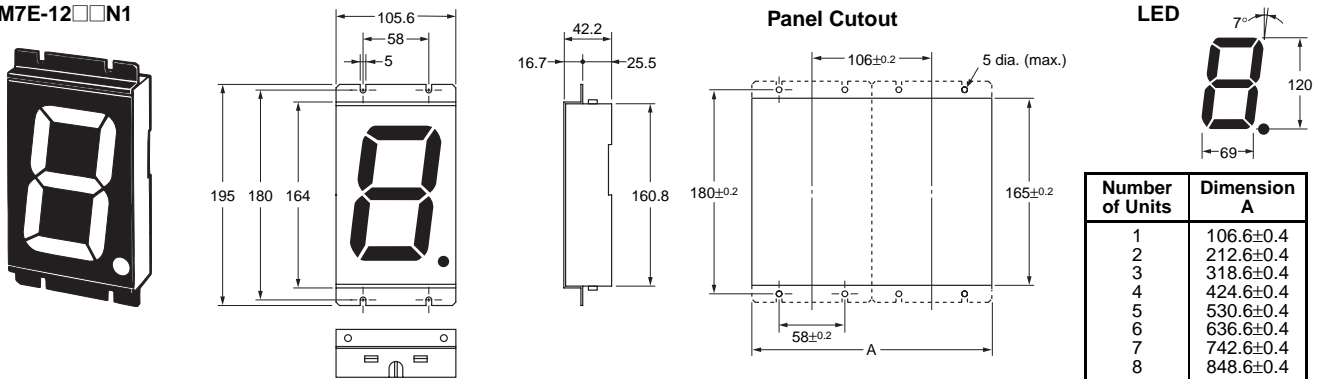

M7E-20□□N1

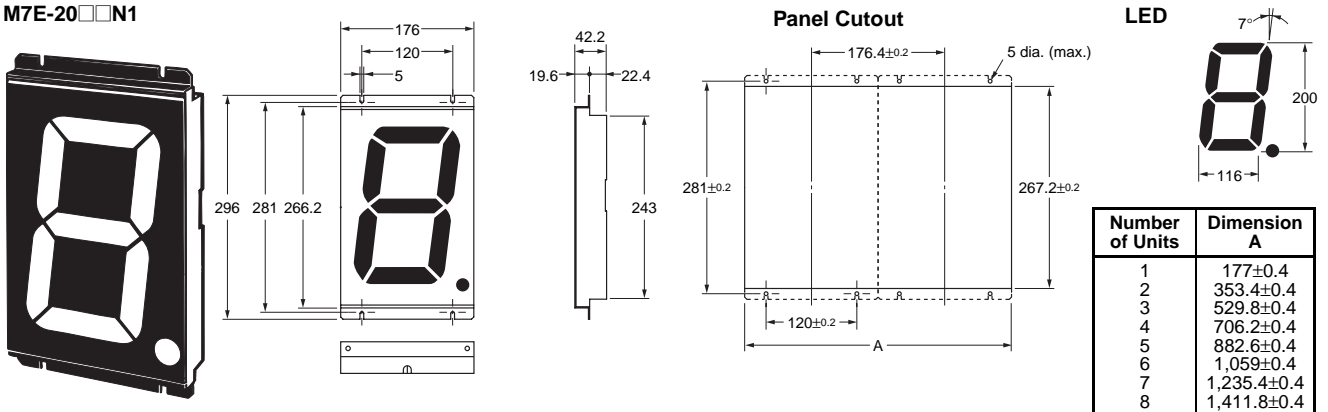

Note: Tolerance is ±0.4 mm unless otherwise specified.

Safety Precautions

■ Precautions for Correct Use

Environment

- Use the switches in locations that are not subject to organic solvents (thinner, benzene, etc.), strong alkali, strong acid, sunlight, corrosive gases, water, and oil.
- Use the units in areas not subject to vibration or shock in excess of specifications.

Wiring

- When wiring with terminals or a connector, remove the rear cover of the M7E and connect the M7E to the terminals or connector properly, and be sure not to leave any wire cuttings inside the Display Unit.

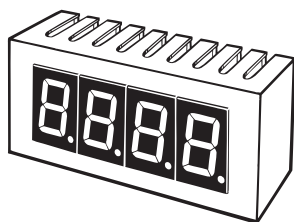

- Make sure that no wire is more than five meters long when wiring the B7A link terminal.

Mounting

When mounting Display Units to a box, make slits on the rear part and the top of the box for ventilation. If there is no proper ventilation, the life of each Display Unit may be shortened.

Connecting Cable

When connecting an XG4M-2030 or XG4M-2030-T G79 Cable to a Digital Display with 80-mm-high Characters, an XG4Z-0002 Lock Lever can be used.

ALL DIMENSIONS SHOWN ARE IN MILLIMETERS.

To convert millimeters into inches, multiply by 0.03937. To convert grams into ounces, multiply by 0.03527.

In the interest of product improvement, specifications are subject to change without notice.

Terms and Conditions Agreement

Read and understand this catalog.

Please read and understand this catalog before purchasing the products. Please consult your OMRON representative if you have any questions or comments.

Warranties.

(a) Exclusive Warranty. Omron's exclusive warranty is that the Products will be free from defects in materials and workmanship for a period of twelve months from the date of sale by Omron (or such other period expressed in writing by Omron). Omron disclaims all other warranties, express or implied.

(b) Limitations. OMRON MAKES NO WARRANTY OR REPRESENTATION, EXPRESS OR IMPLIED, ABOUT NON-INFRINGEMENT, MERCHANTABILITY OR FITNESS FOR A PARTICULAR PURPOSE OF THE PRODUCTS. BUYER ACKNOWLEDGES THAT IT ALONE HAS DETERMINED THAT THE PRODUCTS WILL SUITABLY MEET THE REQUIREMENTS OF THEIR INTENDED USE.

Omron further disclaims all warranties and responsibility of any type for claims or expenses based on infringement by the Products or otherwise of any intellectual property right. (c) Buyer Remedy. Omron's sole obligation hereunder shall be, at Omron's election, to (i) replace (in the form originally shipped with Buyer responsible for labor charges for removal or replacement thereof) the non-complying Product, (ii) repair the non-complying Product, or (iii) repay or credit Buyer an amount equal to the purchase price of the non-complying Product; provided that in no event shall Omron be responsible for warranty, repair, indemnity or any other claims or expenses regarding the Products unless Omron's analysis confirms that the Products were properly handled, stored, installed and maintained and not subject to contamination, abuse, misuse or inappropriate modification. Return of any Products by Buyer must be approved in writing by Omron before shipment. Omron Companies shall not be liable for the suitability or unsuitability or the results from the use of Products in combination with any electrical or electronic components, circuits, system assemblies or any other materials or substances or environments. Any advice, recommendations or information given orally or in writing, are not to be construed as an amendment or addition to the above warranty.

See <http://www.omron.com/global/> or contact your Omron representative for published information.

Limitation on Liability; Etc.

OMRON COMPANIES SHALL NOT BE LIABLE FOR SPECIAL, INDIRECT, INCIDENTAL, OR CONSEQUENTIAL DAMAGES, LOSS OF PROFITS OR PRODUCTION OR COMMERCIAL LOSS IN ANY WAY CONNECTED WITH THE PRODUCTS, WHETHER SUCH CLAIM IS BASED IN CONTRACT, WARRANTY, NEGLIGENCE OR STRICT LIABILITY.

Further, in no event shall liability of Omron Companies exceed the individual price of the Product on which liability is asserted.

Suitability of Use.

Omron Companies shall not be responsible for conformity with any standards, codes or regulations which apply to the combination of the Product in the Buyer's application or use of the Product. At Buyer's request, Omron will provide applicable third party certification documents identifying ratings and limitations of use which apply to the Product. This information by itself is not sufficient for a complete determination of the suitability of the Product in combination with the end product, machine, system, or other application or use. Buyer shall be solely responsible for determining appropriateness of the particular Product with respect to Buyer's application, product or system. Buyer shall take application responsibility in all cases.

NEVER USE THE PRODUCT FOR AN APPLICATION INVOLVING SERIOUS RISK TO LIFE OR PROPERTY OR IN LARGE QUANTITIES WITHOUT ENSURING THAT THE SYSTEM AS A WHOLE HAS BEEN DESIGNED TO ADDRESS THE RISKS, AND THAT THE OMRON PRODUCT(S) IS PROPERLY RATED AND INSTALLED FOR THE INTENDED USE WITHIN THE OVERALL EQUIPMENT OR SYSTEM.

Programmable Products.

Omron Companies shall not be responsible for the user's programming of a programmable Product, or any consequence thereof.

Performance Data.

Data presented in Omron Company websites, catalogs and other materials is provided as a guide for the user in determining suitability and does not constitute a warranty. It may represent the result of Omron's test conditions, and the user must correlate it to actual application requirements. Actual performance is subject to the Omron's Warranty and Limitations of Liability.

Change in Specifications.

Product specifications and accessories may be changed at any time based on improvements and other reasons. It is our practice to change part numbers when published ratings or features are changed, or when significant construction changes are made. However, some specifications of the Product may be changed without any notice. When in doubt, special part numbers may be assigned to fix or establish key specifications for your application. Please consult with your Omron's representative at any time to confirm actual specifications of purchased Product.

Errors and Omissions.

Information presented by Omron Companies has been checked and is believed to be accurate; however, no responsibility is assumed for clerical, typographical or proofreading errors or omissions.

Mouser Electronics

Authorized Distributor

Click to View Pricing, Inventory, Delivery & Lifecycle Information:

Omron:

[B7AP-M1C](#) [B7AP-S1C](#) [B7AS-R6B16](#) [B7AS-R6B31](#) [B7AS-T6B1](#)