

Driver for Digital Still Camera

1ch Lens Drivers for SLRs(Single-lens Reflex)



BD6376GUL

●General Description

The BD6376GUL motor driver provides 1 Full-On Driver H-Bridge channel.
This driver features wide range operating from 2.0V and low power consumption by fast switching speed.
In addition, in a compact surface mount package adopt small mobile system, home appliance, and amusement system etc.

●Features

- Low ON-Resistance Power DMOS output
Upper & lower total: 0.45Ω(Typ.)
- Range of motor power supply voltage: 2.0 to 9.0V
- Charge pump-less type with p-channel DMOS for the upper side transistor
- Maximum output current for H-bridge: 1.0A (DC)
- High-speed switching:
Turn On Time: 200ns, Turn Off Time: 60ns(Typ.)
- With built-in Under Voltage Locked Out protection and Thermal Shut Down circuit
- Stand-by current: 0μA (Typ.)

●Applications

- Small mobile system
- Home appliance
- Amusement system, etc

●Key Specifications

- Power supply voltage range(V_{CC}): 2.5 to 3.6V
- Motor power supply voltage range(V_M): 2.0 to 9.0V
- Circuit Current (Open Mode): 360μA (Typ.)
- Stand-by Current: 1μA(Max.)
- Control input voltage: 0 to V_{CC}V
- Logic input frequency: 200kHz(Max.)
- Minimum logic input pulse width: 0.5μs(Min.)
- Turn On Time: 200ns(Typ.)
- Turn Off Time: 60ns(Typ.)
- Output ON-Resistance (Total): 0.45Ω(Typ.)
- Operating temperature range: -30 to +85°C

●Package

VCSP50L1

W(Typ.) x D(Typ.) x H(Max.)
1.60mm x 1.60mm x 0.55mm



●Ordering Information

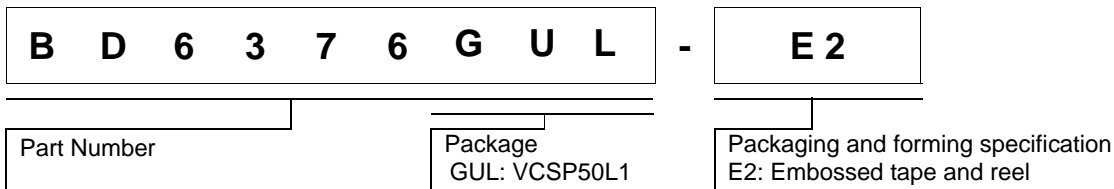

●Block Diagram / Application Example

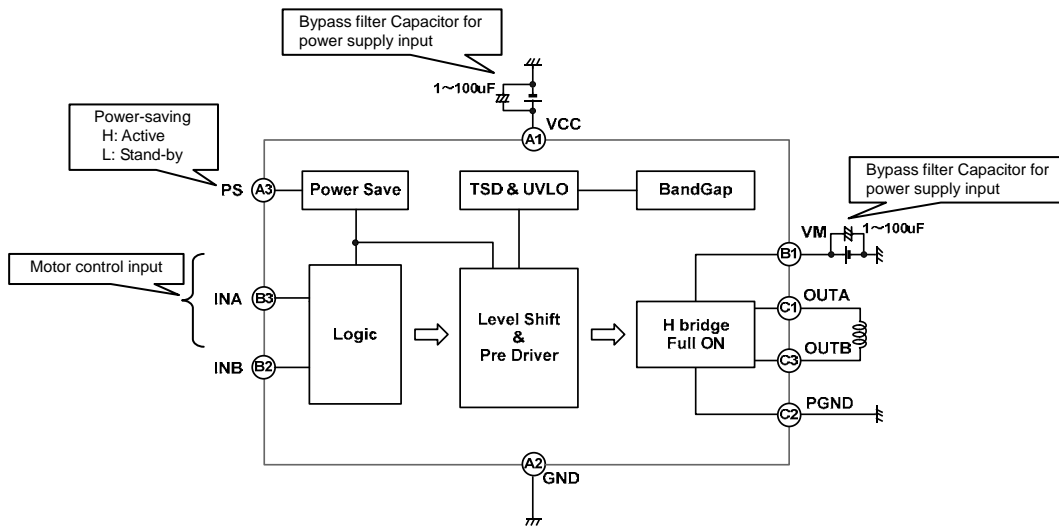

Figure 1. Block Diagram / Application Example

●Pin Configuration

	1	2	3
A	VCC	GND	PS
B	VM	INB	INA
C	OUTA	PGND	OUTB

Figure 2. Pin Configuration (Top View)

●Pin Description

Table 1. Pin Description

No.	Name	Function
A1	VCC	Power supply terminal
A2	GND	Ground terminal
A3	PS	Power-saving terminal
B1	VM	Motor power supply terminal
B2	INB	Control input terminal B
B3	INA	Control input terminal A
C1	OUTA	H-bridge output terminal A
C2	PGND	Motor ground terminal
C3	OUTB	H-bridge output terminal B

● Absolute Maximum Ratings(Ta=+25°C)

Parameter	Symbol	Limit	Unit
Power supply voltage	V _{CC}	-0.3 to +4.5	V
Motor power supply voltage	V _M	-0.3 to +10.0	V
Control input voltage	V _{IN}	-0.3 to V _{CC} +0.3	V
Power dissipation	P _d	725 ^{*1}	mW
H-bridge output current (DC)	I _{OUT}	±1.0 ^{*2}	A
Storage temperature range	T _{stg}	-55 to +150	°C
Junction temperature	T _{jmax}	+150	°C

*1 Reduced by 5.8mW/°C over 25°C, when mounted on a glass epoxy 8 layers board (50mm × 58mm × 1.75mm)

*2 Must not exceed P_d, A_{SO}, or T_{jmax} of 150°C.

● Recommended Operating Ratings

Parameter	Symbol	Limit	Unit
Power supply voltage	V _{CC}	2.5 to 3.6	V
Motor power supply voltage	V _M	2.0 to 9.0	V
Control input voltage	V _{IN}	0 to V _{CC}	V
Logic input frequency	F _{IN}	0 to 200	kHz
Min. logic input pulse width	T _{IN}	0.5	μs
Operating temperature range	T _{opr}	-30 to +85	°C

●Electrical Characteristics (Unless otherwise specified Ta=+25°C, V_{CC}=3.0V, V_M=5.0V)

Parameter	Symbol	Limit			Unit	Condition
		Min.	Typ.	Max.		
All Circuits						
Stand-by Current	I _{CCST}	-	0	1	μA	V _{PS} =0V
Circuit Current 1	I _{CC1}	180	360	550	μA	V _{PS} =3V, Open Mode
Circuit Current 2	I _{CC2}	180	375	550	μA	V _{PS} =3V, CW & CCW Mode
Circuit Current 3	I _{CC3}	180	375	550	μA	V _{PS} =3V, Short Brake Mode
PS Input (PS)						
High-level input voltage	V _{PSH}	2.0	-	V _{CC}	V	
Low-level input voltage	V _{PSL}	0	-	0.7	V	
High-level input current	I _{PSH}	6	15	30	μA	V _{PS} =3V
Low-level input current	I _{PSL}	-1	0	1	μA	V _{PS} =0V
Control Input (INA, INB)						
High-level input voltage	V _{INH}	2.0	-	V _{CC}	V	
Low-level input voltage	V _{INL}	0	-	0.7	V	
High-level input current	I _{INH}	6	15	30	μA	V _{IN} =3V
Low-level input current	I _{INL}	-1	0	1	μA	V _{IN} =0V
Under Voltage Locked Out (UVLO)						
UVLO Voltage	V _{UVLO}	2.0	-	2.4	V	
Full ON type H-Bridge Driver						
Output ON-Resistance	R _{ON}	-	0.45	0.60	Ω	I _{OUT} =±500mA, Upper & Lower total
Turn On Time	T _{ON}	-	200	400	ns	20Ω Loading
Turn Off Time	T _{OFF}	-	60	400	ns	20Ω Loading

● Typical Performance Curves (reference data)

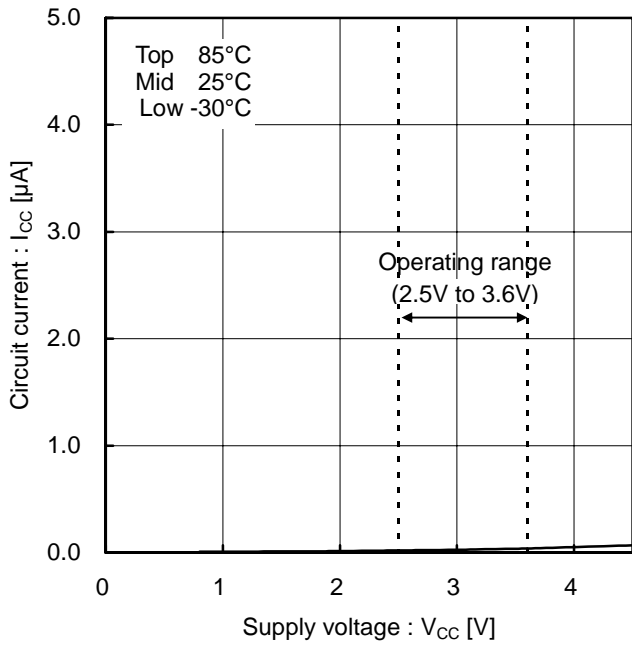

Figure 3. Circuit Current(Stand-by Mode)

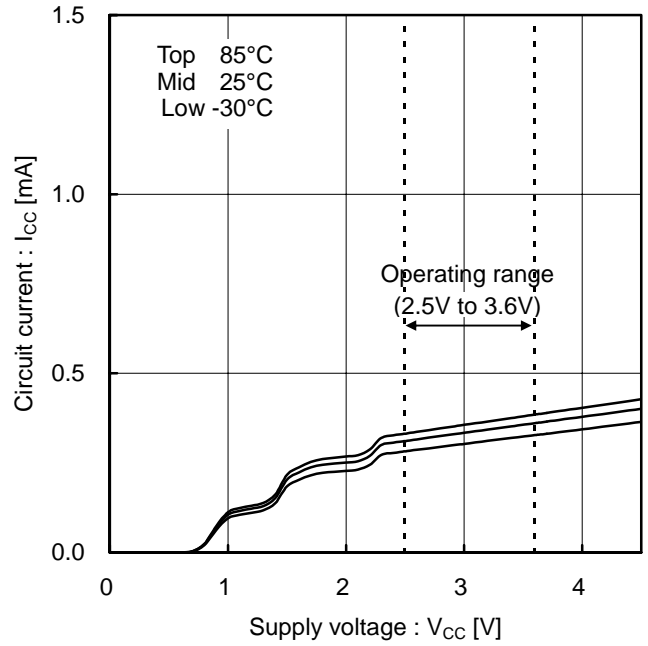

Figure 4. Circuit Current(Open Mode)

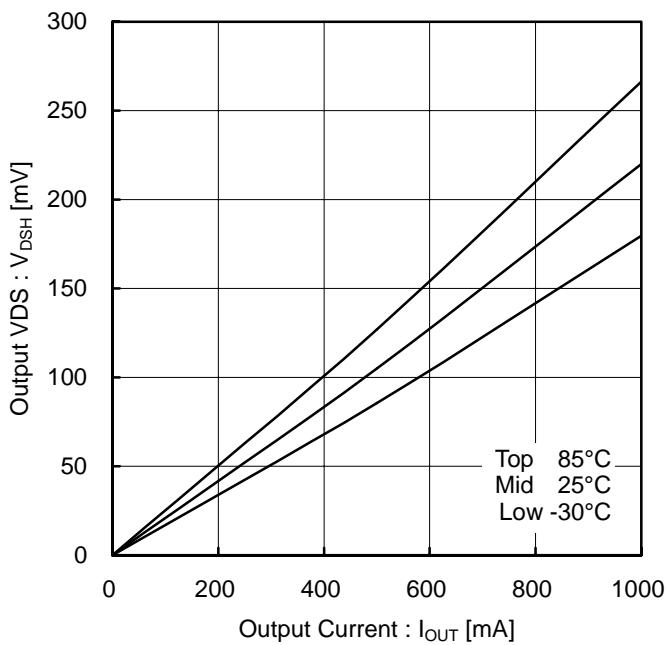

Figure 5. Output ON-Resistance on high-side
($V_M=5V, V_{CC}=3V$)

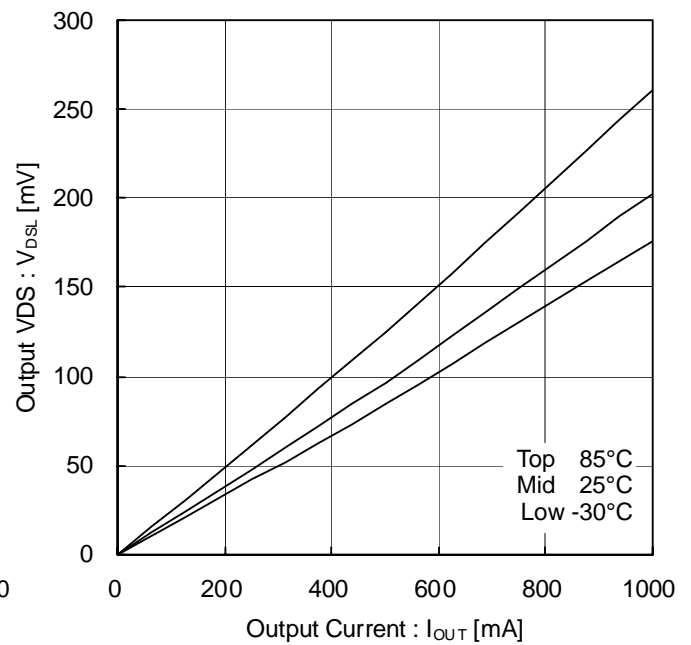

Figure 6. Output ON-Resistance on low-side
($V_M=5V, V_{CC}=3V$)

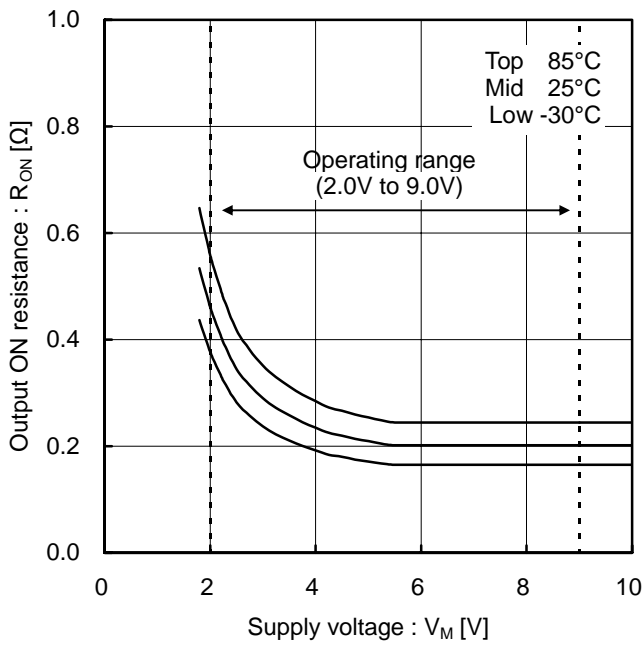

Figure 7. Output ON-Resistance on high-side (V_M Dependency, $V_{CC}=3V$)

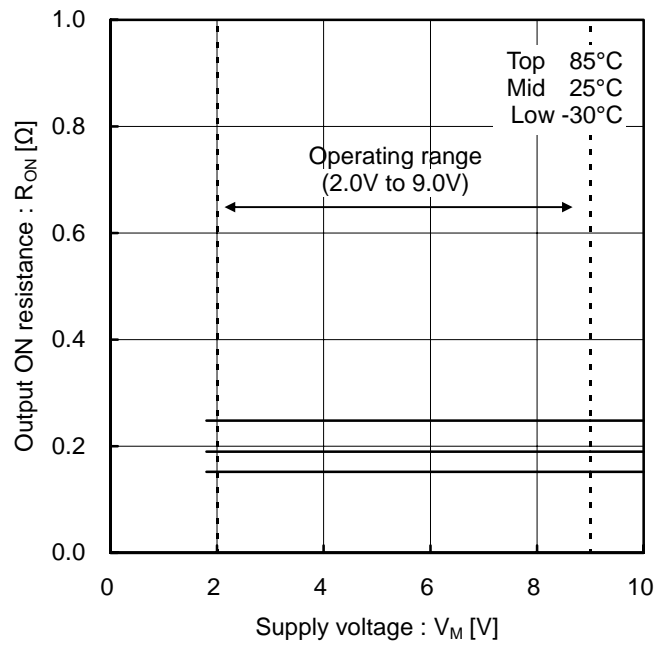

Figure 8. Output ON-Resistance on low-side (V_M Dependency, $V_{CC}=3V$)

●Description of Blocks

- 1) Power-saving function
 When Low-level voltage is applied to PS pin, the IC will be turned off internally.
 During operating mode, PS pin should be High-level.
 (See the Electrical Characteristics; p4/11, and Timing Chart; p7/11)

- 2) Control input; INA and INB
 These pins are used to program and control the motor drive modes.
 (See the Electrical Characteristics; p4/11, and Timing Chart; p7/11)

●Timing Chart

Input Mode	INPUT			OUTPUT		
	PS	INA	INB	OUTA	OUTB	Output Mode
IN/IN	H	L	L	Z	Z	Open
		H	L	H	L	CW
		L	H	L	H	CCW
		H	H	L	L	Short Brake
-	L	X	X	Z	Z	Open

L: Low, H: High, X: Don't care, Z: Hi impedance
 PS=High; Operation Mode, PS=Low; Stand-by Mode
 CW: current flows from OUTA to OUTB, CCW: current flows from OUTB to OUTA

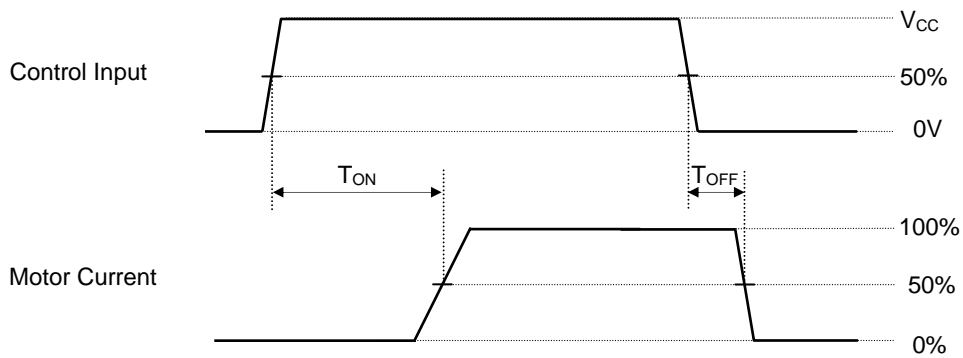

Figure 9. Input-Output AC Definition

● Power Dissipation

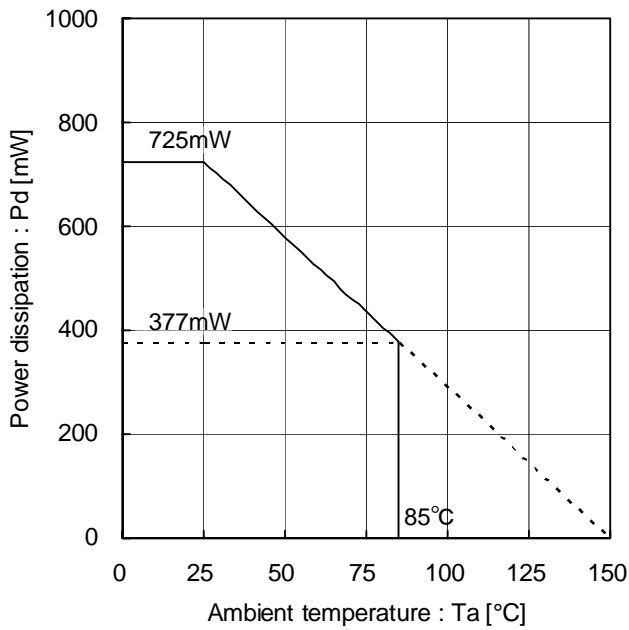

Figure 10. Power Dissipation Curve

● I/O equivalence circuit

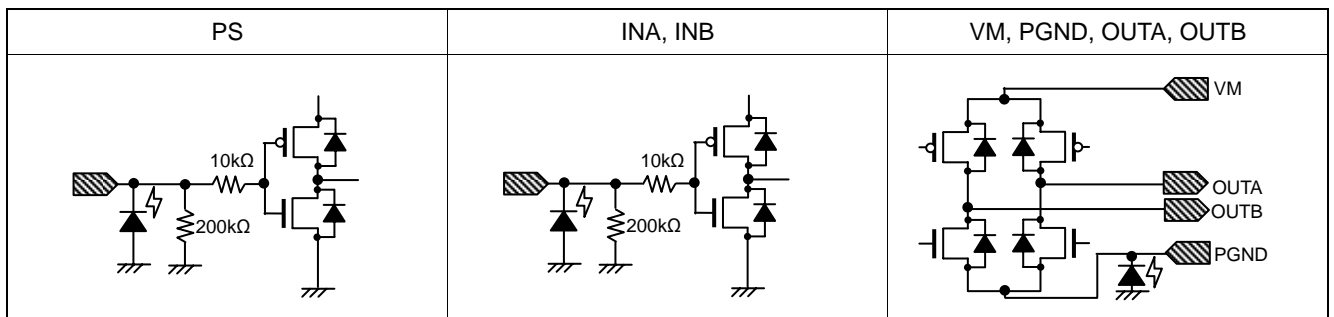

Figure 11. I/O equivalence circuit

●Operational Notes

- 1) Absolute maximum ratings
Use of the IC in excess of absolute maximum ratings such as the applied voltage or operating temperature range (Topr) may result in IC damage. Assumptions should not be made regarding the state of the IC (short mode or open mode) when such damage is suffered. The implementation of a physical safety measure such as a fuse should be considered when use of the IC in a special mode where the absolute maximum ratings may be exceeded is anticipated.
- 2) Power supply pins and lines
None of the VM line for the H-bridge is internally connected to the VCC power supply line, which is only for the control logic or analog circuit. Therefore, the VM and VCC lines can be driven at different voltages. Although these lines can be connected to a common power supply, do not open the power supply pin but connect it to the power supply externally.
Regenerated current may flow as a result of the motor's back electromotive force. Insert capacitors between the power supply and ground pins to serve as a route for regenerated current. Determine the capacitance in full consideration of all the characteristics of the electrolytic capacitor, because the electrolytic capacitor may lose some capacitance at low temperatures. If the connected power supply does not have sufficient current absorption capacity, regenerative current will cause the voltage on the power supply line to rise, which combined with the product and its peripheral circuitry may exceed the absolute maximum ratings. It is recommended to implement a physical safety measure such as the insertion of a voltage clamp diode between the power supply and ground pins. For this IC with 2 power supplies and a part consists of the CMOS block, it is possible that rush current may flow instantaneously due to the internal powering sequence and delays, and to the unstable internal logic, respectively. Therefore, give special consideration to power coupling capacitance, width of power and ground wirings, and routing of wiring.
- 3) Ground pins and lines
Ensure a minimum GND pin potential in all operating conditions. Make sure that no pins are at a voltage below the GND at any time, regardless of whether it is a transient signal or not.
When using both small signal GND and large current PGND patterns, it is recommended to isolate the two ground patterns, placing a single ground point at the application's reference point so that the pattern wiring resistance and voltage variations caused by large currents do not cause variations in the small signal ground voltage. Be careful not to change the GND wiring pattern of any external components, either.
The power supply and ground lines must be as short and thick as possible to reduce line impedance.
- 4) Thermal design
Use a thermal design that allows for a sufficient margin in light of the power dissipation (Pd) in actual operating conditions.
- 5) Actions in strong magnetic field
Use caution when using the IC in the presence of a strong magnetic field as doing so may cause the IC to malfunction.
- 6) ASO
When using the IC, set the output transistor for the motor so that it does not exceed absolute maximum ratings or ASO.
- 7) Thermal shutdown circuit
This IC incorporates a TSD (thermal shutdown) circuit. If the temperature of the chip reaches the following temperature, the motor coil output will be opened. The TSD circuit is designed only to shut the IC off to prevent runaway thermal operation. It is not designed to protect the IC or guarantee its operation. Do not continue to use the IC after operating this circuit or use the IC in an environment where the operation of this circuit is assumed.

TSD ON temperature [°C] (Typ.)	Hysteresis temperature [°C] (Typ.)
175	20

- 8) Application example
The application circuit is recommended for use. Make sure to confirm the adequacy of the characteristics. When using the circuit with changes to the external circuit constants, make sure to leave an adequate margin for external components including static and transitional characteristics as well as dispersion of the IC.

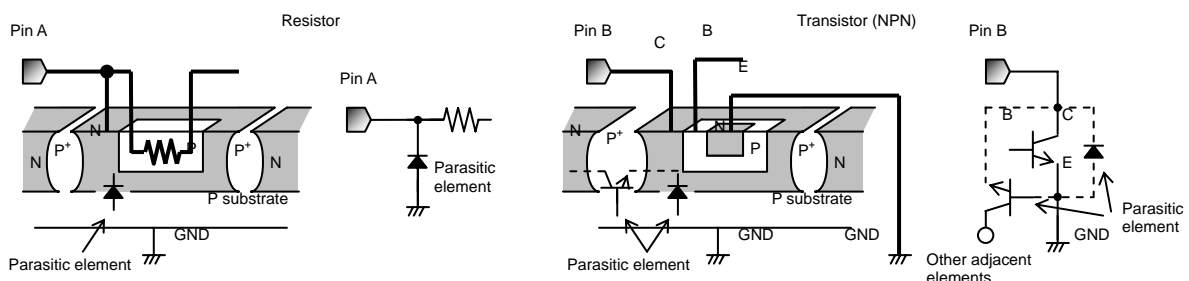

Figure 12. Example of Simple IC Architecture

Status of this document

The Japanese version of this document is formal specification. A customer may use this translation version only for a reference to help reading the formal version.
If there are any differences in translation version of this document, formal version takes priority.

●Physical Dimension, Tape and Reel Information

VCSP50L1 (BD6376GUL)

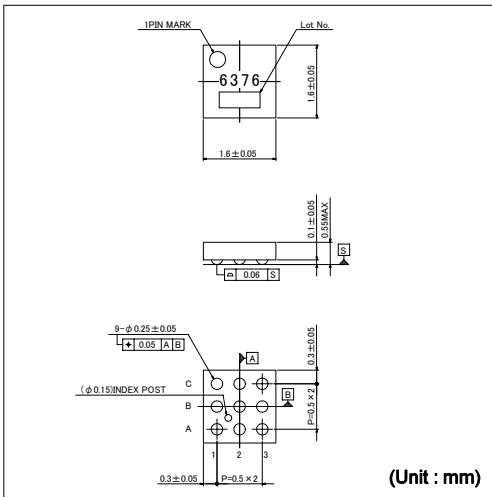

<Tape and Reel information>

Tape	Embossed carrier tape
Quantity	3000pcs
Direction of feed	E2 (The direction is the 1pin of product is at the upper left when you hold reel on the left hand and you pull out the tape on the right hand)

*Order quantity needs to be multiple of the minimum quantity.

●Marking Diagram

VCSP50L1 (TOP VIEW)

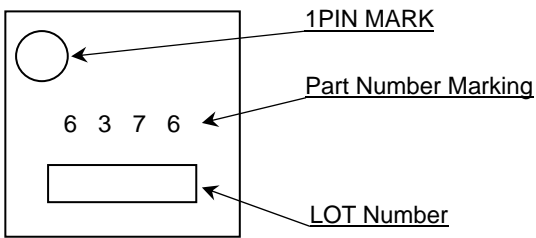

●Revision History

Date	Revision	Changes
3.Aug.2012	001	New release
6.Feb.2014	002	p1 Change [1-2ch] to [1ch]

Notice

Precaution on using ROHM Products

- Our Products are designed and manufactured for application in ordinary electronic equipments (such as AV equipment, OA equipment, telecommunication equipment, home electronic appliances, amusement equipment, etc.). If you intend to use our Products in devices requiring extremely high reliability (such as medical equipment ^(Note 1), transport equipment, traffic equipment, aircraft/spacecraft, nuclear power controllers, fuel controllers, car equipment including car accessories, safety devices, etc.) and whose malfunction or failure may cause loss of human life, bodily injury or serious damage to property ("Specific Applications"), please consult with the ROHM sales representative in advance. Unless otherwise agreed in writing by ROHM in advance, ROHM shall not be in any way responsible or liable for any damages, expenses or losses incurred by you or third parties arising from the use of any ROHM's Products for Specific Applications.

(Note1) Medical Equipment Classification of the Specific Applications

JAPAN	USA	EU	CHINA
CLASS III	CLASS III	CLASS II b	CLASS III
CLASS IV		CLASS III	

- ROHM designs and manufactures its Products subject to strict quality control system. However, semiconductor products can fail or malfunction at a certain rate. Please be sure to implement, at your own responsibilities, adequate safety measures including but not limited to fail-safe design against the physical injury, damage to any property, which a failure or malfunction of our Products may cause. The following are examples of safety measures:
 - Installation of protection circuits or other protective devices to improve system safety
 - Installation of redundant circuits to reduce the impact of single or multiple circuit failure
- Our Products are designed and manufactured for use under standard conditions and not under any special or extraordinary environments or conditions, as exemplified below. Accordingly, ROHM shall not be in any way responsible or liable for any damages, expenses or losses arising from the use of any ROHM's Products under any special or extraordinary environments or conditions. If you intend to use our Products under any special or extraordinary environments or conditions (as exemplified below), your independent verification and confirmation of product performance, reliability, etc. prior to use, must be necessary:
 - Use of our Products in any types of liquid, including water, oils, chemicals, and organic solvents
 - Use of our Products outdoors or in places where the Products are exposed to direct sunlight or dust
 - Use of our Products in places where the Products are exposed to sea wind or corrosive gases, including Cl₂, H₂S, NH₃, SO₂, and NO₂
 - Use of our Products in places where the Products are exposed to static electricity or electromagnetic waves
 - Use of our Products in proximity to heat-producing components, plastic cords, or other flammable items
 - Sealing or coating our Products with resin or other coating materials
 - Use of our Products without cleaning residue of flux (even if you use no-clean type fluxes, cleaning residue of flux is recommended); or Washing our Products by using water or water-soluble cleaning agents for cleaning residue after soldering
 - Use of the Products in places subject to dew condensation
- The Products are not subject to radiation-proof design.
- Please verify and confirm characteristics of the final or mounted products in using the Products.
- In particular, if a transient load (a large amount of load applied in a short period of time, such as pulse. is applied, confirmation of performance characteristics after on-board mounting is strongly recommended. Avoid applying power exceeding normal rated power; exceeding the power rating under steady-state loading condition may negatively affect product performance and reliability.
- De-rate Power Dissipation (Pd) depending on Ambient temperature (Ta). When used in sealed area, confirm the actual ambient temperature.
- Confirm that operation temperature is within the specified range described in the product specification.
- ROHM shall not be in any way responsible or liable for failure induced under deviant condition from what is defined in this document.

Precaution for Mounting / Circuit board design

- When a highly active halogenous (chlorine, bromine, etc.) flux is used, the residue of flux may negatively affect product performance and reliability.
- In principle, the reflow soldering method must be used; if flow soldering method is preferred, please consult with the ROHM representative in advance.

For details, please refer to ROHM Mounting specification

Precautions Regarding Application Examples and External Circuits

1. If change is made to the constant of an external circuit, please allow a sufficient margin considering variations of the characteristics of the Products and external components, including transient characteristics, as well as static characteristics.
2. You agree that application notes, reference designs, and associated data and information contained in this document are presented only as guidance for Products use. Therefore, in case you use such information, you are solely responsible for it and you must exercise your own independent verification and judgment in the use of such information contained in this document. ROHM shall not be in any way responsible or liable for any damages, expenses or losses incurred by you or third parties arising from the use of such information.

Precaution for Electrostatic

This Product is electrostatic sensitive product, which may be damaged due to electrostatic discharge. Please take proper caution in your manufacturing process and storage so that voltage exceeding the Products maximum rating will not be applied to Products. Please take special care under dry condition (e.g. Grounding of human body / equipment / solder iron, isolation from charged objects, setting of ionizer, friction prevention and temperature / humidity control).

Precaution for Storage / Transportation

1. Product performance and soldered connections may deteriorate if the Products are stored in the places where:
 - [a] the Products are exposed to sea winds or corrosive gases, including Cl₂, H₂S, NH₃, SO₂, and NO₂
 - [b] the temperature or humidity exceeds those recommended by ROHM
 - [c] the Products are exposed to direct sunshine or condensation
 - [d] the Products are exposed to high Electrostatic
2. Even under ROHM recommended storage condition, solderability of products out of recommended storage time period may be degraded. It is strongly recommended to confirm solderability before using Products of which storage time is exceeding the recommended storage time period.
3. Store / transport cartons in the correct direction, which is indicated on a carton with a symbol. Otherwise bent leads may occur due to excessive stress applied when dropping of a carton.
4. Use Products within the specified time after opening a humidity barrier bag. Baking is required before using Products of which storage time is exceeding the recommended storage time period.

Precaution for Product Label

QR code printed on ROHM Products label is for ROHM's internal use only.

Precaution for Disposition

When disposing Products please dispose them properly using an authorized industry waste company.

Precaution for Foreign Exchange and Foreign Trade act

Since our Products might fall under controlled goods prescribed by the applicable foreign exchange and foreign trade act, please consult with ROHM representative in case of export.

Precaution Regarding Intellectual Property Rights

1. All information and data including but not limited to application example contained in this document is for reference only. ROHM does not warrant that foregoing information or data will not infringe any intellectual property rights or any other rights of any third party regarding such information or data. ROHM shall not be in any way responsible or liable for infringement of any intellectual property rights or other damages arising from use of such information or data.:
2. No license, expressly or implied, is granted hereby under any intellectual property rights or other rights of ROHM or any third parties with respect to the information contained in this document.

Other Precaution

1. This document may not be reprinted or reproduced, in whole or in part, without prior written consent of ROHM.
2. The Products may not be disassembled, converted, modified, reproduced or otherwise changed without prior written consent of ROHM.
3. In no event shall you use in any way whatsoever the Products and the related technical information contained in the Products or this document for any military purposes, including but not limited to, the development of mass-destruction weapons.
4. The proper names of companies or products described in this document are trademarks or registered trademarks of ROHM, its affiliated companies or third parties.

General Precaution

1. Before you use our Products, you are requested to carefully read this document and fully understand its contents. ROHM shall not be in any way responsible or liable for failure, malfunction or accident arising from the use of any ROHM's Products against warning, caution or note contained in this document.
2. All information contained in this document is current as of the issuing date and subject to change without any prior notice. Before purchasing or using ROHM's Products, please confirm the latest information with a ROHM sales representative.
3. The information contained in this document is provided on an "as is" basis and ROHM does not warrant that all information contained in this document is accurate and/or error-free. ROHM shall not be in any way responsible or liable for any damages, expenses or losses incurred by you or third parties resulting from inaccuracy or errors of or concerning such information.