

# Bridgelux ES Rectangle Array Series

## Product Data Sheet DS24

**BXRA-xxx0800, BXRA-xxx1200, BXRA-xxx2000**  
**BXRA-40E0950, BXRA-40E1350, BXRA-40E2200**  
**BXRA-xxC1100, BXRA-xxC1600, BXRA-xxC2600**

### Introduction

The Bridgelux family of LED Array products delivers high performance, compact and cost-effective solid-state lighting solutions to serve the general lighting market. These products combine the higher efficacy, lifetime, and reliability benefits of LEDs with the light output levels of many conventional lighting sources. The Bridgelux ES Array Series enables lamp and luminaire designs surpassing efficacy and quality of light requirements driven by regulatory standards with reasonable system design margins, enabling lighting product compliance to Energy Star, DLC, Title 24, Part L and other global standards.

The Bridgelux ES Array products are a high performance alternative to conventional solid state solutions, delivering between 700 and 3000 lumens under application conditions in warm, neutral and cool white color temperatures. These compact high flux density light sources deliver uniform high quality illumination without pixilation or the multiple shadow effect caused by LED component based solutions. To simplify system design for appropriate light output, Bridgelux LED Arrays are specified to deliver performance under typical use conditions.

These integrated plug and play solutions reduce system complexity and enable miniaturized cost-effective lamp and luminaire designs. Lighting system designs incorporating these LED Arrays deliver comparable performance to that of 60-200 Watt incandescent and halogen, 7-42 Watt compact fluorescent, and 18-50 Watt HID based luminaires and feature increased system level efficacy and service life. Typical applications include replacement lamps, task, accent, spot, retail, track, down light, low bay, wide area, security, wall pack and street lighting.

### Features

- Compact high flux density light source
- Uniform high quality illumination
- Minimum 70, 80 and 90 CRI options
- Streamlined thermal path
- Energy Star / ANSI compliant color binning structure with 3SDCM options
- More energy efficient than incandescent, halogen and fluorescent lamps
- Low voltage DC operation
- Instant light with unlimited dimming
- 5-Year warranty
- RoHS compliant and Pb free

### Benefits

- Enhanced optical control
- Clean white light without pixilation
- High quality true color reproduction
- Significantly reduced thermal resistance and increased operating temperatures
- Uniform consistent white light
- Lower operating costs
- UL Recognized
- Easy to use with daylight and motion detectors to enable increased energy savings
- Reduced maintenance costs
- Environmentally friendly, no disposal issue



---

Table of Contents	Page
Typical Product Features	3
Product Nomenclature	3
UL Recognition	4
CE Recognition	4
Selection Guide	6
Typical Performance at Alternative Drive Currents	7
Flux Characteristics	10
Electrical Characteristics	11
Absolute Maximum Ratings	12
Typical Relative Luminous Flux vs. Current	16
Typical Radiation Pattern	19
Typical Spectral Characteristics	20
Mechanical Dimensions	21
Color Binning Information	22
Color Control Options	26
Design Resources	27
About Bridgelux	28

---

## Typical Product Features

Bridgelux arrays are fully engineered devices that provide consistent thermal and optical performance on an engineered mechanical platform. The ES Rectangle array is a general purpose chip-on-board device serving a wide range of applications. The arrays incorporate several features to simplify design integration and assembly.

Figure 1: Array Features

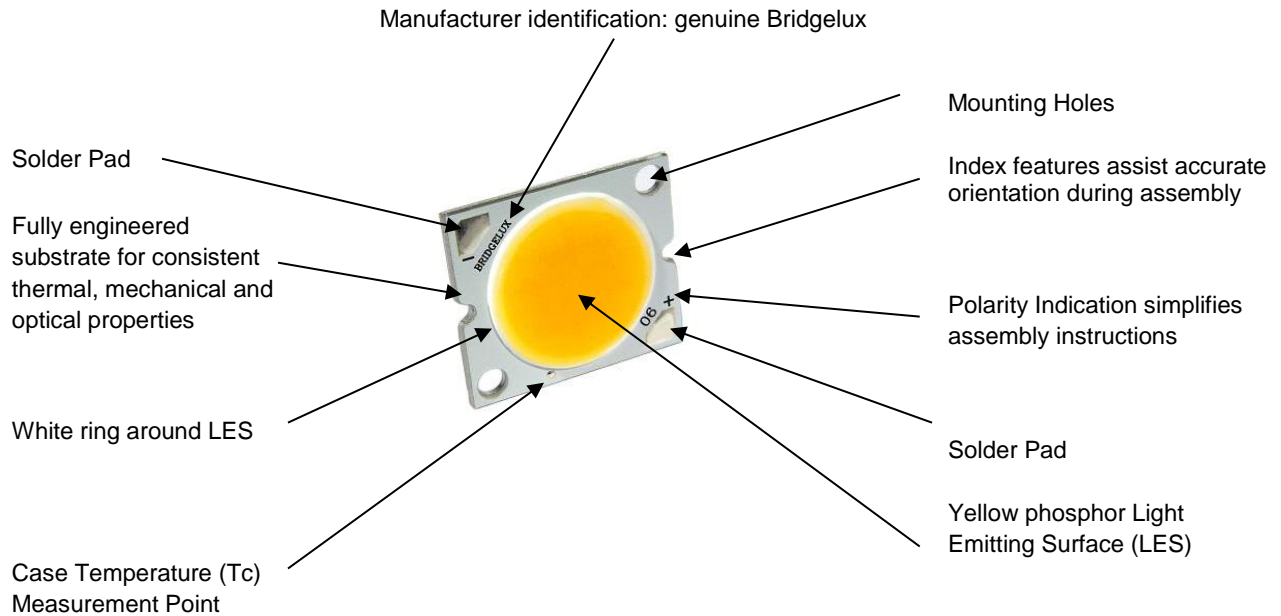

Note: Part number and lot codes are scribed on back of array

## Product Nomenclature

The part number designation for Bridgelux LED Arrays is explained as follows:

BXRA – AB C DEFG – H – IJ

Where:

B X R A – Designates product family

A B – Designates the nominal ANSI color temperature; 27 = 2700K; 30 = 3000K, etc.

C - Designates minimum CRI; C = 70, E = 80, G = 90

D E F G - Designates Nominal Flux; 0800 = 800lm, 1200 = 1200lm, 2000 = 2000lm, etc.

H – Designates array configuration

I J – Designates CCT Bin options

03 = 3SDCM or 3-step

04 = 4SDCM or 4-step

00 = 7SDCM or 7-step

---

## Lumen Maintenance Characteristics

Bridgelux projects that its family of LED Array products will deliver, on average, greater than 70% lumen maintenance after 50,000 hours of operation at the rated forward test current. This performance assumes constant current operation at the nominal drive current with case temperature maintained at or below 85°C. For use beyond these typical operating conditions please consult your Bridgelux sales representative for further assistance.

These projections are based on a combination of package test data, semiconductor chip reliability data, a fundamental understanding of package related degradation mechanisms, and performance observed from products installed in the field using Bridgelux die technology. Bridgelux conducts lumen maintenance tests per LM80. Observation of design limits is required in order to achieve this projected lumen maintenance.

## Environmental Compliance

Bridgelux is committed to providing environmentally friendly products to the solid state lighting market. Bridgelux LED Arrays comply with the European Union directives on the restriction of hazardous substances in electronic equipment, namely the RoHS directive. Bridgelux does not intentionally add the following restricted materials to LED Array products: lead, mercury, cadmium, hexavalent chromium, polybrominated biphenyls (PBB) or polybrominated diphenyl ethers (PBDE).

## UL Recognition

Bridgelux secures UL recognition for all the LED Array products. Please refer to the UL file E350613 for the latest list of UL recognized Arrays. Bridgelux uses UL recognized materials with suitable flammability ratings in the LED Array to streamline the process for customers to secure UL listing of the final luminaire product.

## CE Recognition

In accordance with the relevant European Union directives, the family of LED Array products conform to the applicable requirements of the IEC/EN 62031:2008 (LED Modules for General Lighting Safety Specifications) and IEC 62471:2006 (Photobiological Safety of Lamps and Lamp Systems). Bridgelux maintains a CE Declaration of Conformity statement on its website and displays the CE mark on product packing labels.

## Minor Product Change Policy

The rigorous qualification testing on products offered by Bridgelux provides performance assurance. Slight cosmetic changes that do not affect form, fit, or function may occur as Bridgelux continues product optimization.

## Case Temperature Measurement Point

A case temperature ( $T_c$ ) measurement point location is included on the top surface of the Bridgelux LED Arrays. The location of this measurement point is indicated in the mechanical dimensions section of this data sheet.

The purpose of this measurement point is to allow the user access to a measurement point closely linked to the true case temperature on the back surface of the LED Array. Once the LED Array is installed, it is challenging to measure the back surface of the array, or true case temperature.

Bridgelux has provided the case temperature measurement location in a manner which closely ties it to the true case temperature of the LED Array under steady state operation. Deviations between thermal measurements taken at the point indicated and the back of the LED Array differ by less than 1°C, providing a robust method to testing thermal operation once the product is installed.

---

## Cautionary Statements

### CAUTION: CONTACT WITH OPTICAL AREA

Avoid any contact with the optical area. Do not touch the optical area of the LED Array or apply mechanical stress to the yellow phosphor resin area – it could damage the LED Array.

Optics and reflectors must not be mounted in contact with the yellow phosphor resin area (LES) or the white ring that surrounds the yellow phosphor area. Using the white ring to secure optics can result in damage to the LED Array as the ring is not designed to act as a mechanical locating feature. Optical devices may be mounted on the top surface of the LED Array substrate outside of the white ring maximum OD as specified in the product data sheet. Use the mechanical features of the LED Array substrate edges and/or mounting holes to locate and secure the optical device as needed.

### CAUTION: EYE SAFETY

Eye safety classification for the use of Bridgelux LED Arrays is in accordance with IEC specification EN62471; Photobiological Safety of Lamps and Lamp Systems. Bridgelux LED Arrays are classified as Risk Group 1 (Low Risk) when operated at or below their rated test current. Please use appropriate precautions. It is important that employees working with LEDs are trained to use them safely.

### CAUTION: RISK OF BURN

Do not touch the LED Array or resin area during operation. Allow the LED Array to cool for a sufficient period of time before handling. The LED Array may reach elevated temperatures such that it can burn skin when touched.

### CAUTION: CHEMICAL EXPOSURE HAZARD

Exposure to some chemicals commonly used in luminaire manufacturing and assembly can cause damage to the LED Array. Please consult Application Note AN11 for additional information.

## Selection Guide

The following configurations are available:

Table 1: Selection Guide for ES Rectangular Arrays

Part Number <sup>[1]</sup>	CCT <sup>[2]</sup> (Kelvin)	CRI <sup>[3]</sup>	Test Current <sup>[5]</sup> (mA)	Typical Voltage (V)	Typical Flux <sup>[6]</sup> (lm)		Typical Power <sup>[6]</sup> (W)	Typical Efficacy <sup>[6]</sup> (lm/W)
					T <sub>j</sub> = 25°C	T <sub>case</sub> = 85°C		
BXRA-27E0800-B-03	2700K	80	500	20.5	980	850	10.3	96
BXRA-27E1200-B-03	2700K	80	500	29.3	1420	1230	14.7	97
BXRA-27E2000-B-03	2700K	80	700	36.2	2300	2000	25.3	91
BXRA-27G0800-B-03	2700K	90	500	20.5	830	720	10.3	81
BXRA-27G1200-B-03	2700K	90	500	29.3	1200	1040	14.7	82
BXRA-27G2000-B-03	2700K	90	700	36.2	2020	1760	25.3	80
BXRA-30E0800-B-03	3000K	80	500	20.5	1070	930	10.3	104
BXRA-30E1200-B-03	3000K	80	500	29.3	1540	1340	14.7	105
BXRA-30E2000-B-03	3000K	80	700	36.2	2460	2140	25.3	97
BXRA-30G0800-B-03	3000K	90	500	20.5	900	780	10.3	88
BXRA-30G1200-B-03	3000K	90	500	29.3	1310	1140	14.7	89
BXRA-30G2000-B-03	3000K	90	700	36.2	2080	1810	25.3	82
BXRA-35E0800-B-03	3500K	80	500	20.5	1130	980	10.3	110
BXRA-35E1200-B-03	3500K	80	500	29.3	1630	1420	14.7	111
BXRA-35E2000-B-03	3500K	80	700	36.2	2610	2270	25.3	103
BXRA-40E0950-B-03	4000K	80	500	20.5	1200	1040	10.3	117
BXRA-40E1350-B-03	4000K	80	500	29.3	1720	1500	14.7	117
BXRA-40E2200-B-03	4000K	80	700	36.2	2800	2430	25.3	110
BXRA-50C1100-B-xx	5000K	70	500	20.5	1340	1170	10.3	131
BXRA-50C1600-B-xx	5000K	70	500	29.3	1930	1680	14.7	132
BXRA-50C2600-B-xx	5000K	70	700	36.2	3150	2740	25.3	124
BXRA-56C1100-B-xx	5600K	70	500	20.5	1340	1170	10.3	131
BXRA-56C1600-B-xx	5600K	70	500	29.3	1930	1680	14.7	132
BXRA-56C2600-B-xx	5600K	70	700	36.2	3150	2740	25.3	124

Note for Table 1 through 5 (additional specific notes following Table 2 through 5):

1. Part numbers with "-xx" suffix are available with multiple color control options (4 SDCM or 7 SDCM for example).
2. Nominal CCT as defined by ANSI C78.377-2011.
3. Values are minimum.
4. Minimum R9 value for 90 CRI products is 50.
5. Products tested under pulsed condition (10ms pulse width) at rated test current where T<sub>junction</sub> = T<sub>case</sub> = 25°C.
6. Typical performance values are provided as a reference only and are not a guarantee of performance.
7. Bridgelux maintains a ±7% tolerance on flux measurements.
8. Operating these LED Arrays at or below the drive currents listed in Table 2 and 5, with a case temperature maintained at or below 85°C, will enable the average lumen maintenance projection outlined earlier in this Product Data Sheet.

## Typical Performance at Alternative Drive Currents

Customers may drive the LED Arrays at alternative drive currents dependent on the specific application. The typical performance at any drive current can be derived from the current vs. voltage characteristics shown in Figures 2 and 3 and from the flux versus current characteristics shown in Figure 8 and 9. The typical performance at common drive currents is summarized in Table 2.

Table 2: Typical Product Performance at Alternative Drive Currents

Part Number <sup>[1]</sup>	CCT & CRI	Current <sup>[9]</sup> (mA)	Typical Voltage <sup>[6]</sup> (V)	Typical Power <sup>[6]</sup> (W)	Typical Flux <sup>[6]</sup> (lm)		Typical Efficacy <sup>[6]</sup> (lm/W)
			T <sub>j</sub> = 25°C	T <sub>j</sub> = 25°C	T <sub>j</sub> = 25°C	T <sub>case</sub> = 85°C	T <sub>j</sub> = 25°C
BXRA-27E0800-B-03	2700K and 80 CRI	250	19.4	4.8	510	440	105
		350	19.8	6.9	700	600	101
		500	20.5	10.3	980	850	96
		700	21.3	14.9	1320	1150	89
BXRA-27E1200-B-03	2700K and 80 CRI	250	27.7	6.9	730	630	105
		350	28.3	9.9	1010	870	102
		500	29.3	14.7	1420	1230	97
		700	30.4	21.3	1920	1660	90
BXRA-27E2000-B-03	2700K and 80 CRI	350	34.2	12.0	1190	1030	99
		500	35.1	17.6	1700	1470	97
		700	36.2	25.3	2300	2000	91
		1000	37.7	37.7	3160	2750	84
BXRA-27G0800-B-03	2700K and 90 CRI	250	19.4	4.8	430	370	89
		350	19.8	6.9	590	510	85
		500	20.5	10.3	830	720	81
		700	21.3	14.9	1120	970	75
BXRA-27G1200-B-03	2700K and 90 CRI	250	27.7	6.9	620	540	89
		350	28.3	9.9	850	740	86
		500	29.3	14.7	1200	1040	82
		700	30.4	21.3	1620	1400	76
BXRA-27G2000-B-03	2700K and 90 CRI	350	34.2	12.0	1040	910	87
		500	35.1	17.6	1490	1300	85
		700	36.2	25.3	2020	1760	80
		1000	37.7	37.7	2770	2420	73
BXRA-30E0800-B-03	3000K and 80 CRI	250	19.4	4.8	550	480	113
		350	19.8	6.9	760	660	109
		500	20.5	10.3	1070	930	104
		700	21.3	14.9	1440	1250	97
BXRA-30E1200-B-03	3000K and 80 CRI	250	27.7	6.9	790	690	114
		350	28.3	9.9	1090	950	110
		500	29.3	14.7	1540	1340	105
		700	30.4	21.3	2080	1810	98

Table 2 Continued

Part Number <sup>[1]</sup>	CCT & CRI	Current <sup>[9]</sup> (mA)	Typical Voltage <sup>[6]</sup> (V)	Typical Power <sup>[6]</sup> (W)	Typical Flux <sup>[6]</sup> (lm)		Typical Efficacy <sup>[6]</sup> (lm/W)
			T <sub>j</sub> = 25°C	T <sub>j</sub> = 25°C	T <sub>j</sub> = 25°C	T <sub>case</sub> = 85°C	T <sub>j</sub> = 25°C
BXRA-30E2000-B-03	3000K and 80 CRI	350	34.2	12.0	1270	1100	106
		500	35.1	17.6	1810	1580	103
		700	36.2	25.3	2460	2140	97
		1000	37.7	37.7	3380	2940	90
BXRA-30G0800-B-03	3000K and 90 CRI	250	19.4	4.8	460	400	95
		350	19.8	6.9	640	550	92
		500	20.5	10.3	900	780	88
		700	21.3	14.9	1210	1050	81
BXRA-30G1200-B-03	3000K and 90 CRI	250	27.7	6.9	680	590	98
		350	28.3	9.9	930	810	94
		500	29.3	14.7	1310	1140	89
		700	30.4	21.3	1770	1540	83
BXRA-30G2000-B-03	3000K and 90 CRI	350	34.2	12.0	1070	930	89
		500	35.1	17.6	1530	1330	87
		700	36.2	25.3	2080	1810	82
		1000	37.7	37.7	2860	2490	76
BXRA-35E0800-B-03	3500K and 80 CRI	250	19.4	4.8	580	510	120
		350	19.8	6.9	800	700	115
		500	20.5	10.3	1130	980	110
		700	21.3	14.9	1520	1320	102
BXRA-35E1200-B-03	3500K and 80 CRI	250	27.7	6.9	840	730	121
		350	28.3	9.9	1160	1010	117
		500	29.3	14.7	1630	1420	111
		700	30.4	21.3	2200	1920	103
BXRA-35E2000-B-03	3500K and 80 CRI	350	34.2	12.0	1350	1170	113
		500	35.1	17.6	1920	1670	109
		700	36.2	25.3	2610	2270	103
		1000	37.7	37.7	3590	3120	95
BXRA-40E0950-B-03	4000K and 80 CRI	250	19.4	4.8	620	540	128
		350	19.8	6.9	850	740	122
		500	20.5	10.3	1200	1040	117
		700	21.3	14.9	1620	1400	109



Table 2 Continued

Part Number <sup>[1]</sup>	CCT & CRI	Current <sup>[9]</sup> (mA)	Typical Voltage <sup>[6]</sup> (V)	Typical Power <sup>[6]</sup> (W)	Typical Flux <sup>[6]</sup> (lm)		Typical Efficacy <sup>[6]</sup> (lm/W)
			T <sub>j</sub> = 25°C	T <sub>j</sub> = 25°C	T <sub>j</sub> = 25°C	T <sub>case</sub> = 85°C	T <sub>j</sub> = 25°C
BXRA-40E1350-B-03	4000K and 80 CRI	250	27.7	6.9	890	770	128
		350	28.3	9.9	1220	1070	123
		<b>500</b>	<b>29.3</b>	<b>14.7</b>	<b>1720</b>	<b>1500</b>	<b>117</b>
		700	30.4	21.3	2320	2020	109
BXRA-40E2200-B-03	4000K and 80 CRI	350	34.2	12.0	1440	1250	120
		500	35.1	17.6	2060	1790	117
		<b>700</b>	<b>36.2</b>	<b>25.3</b>	<b>2800</b>	<b>2430</b>	<b>110</b>
		1000	37.7	37.7	3850	3340	102
BXRA-50C1100-B-xx	5000K and 70 CRI	250	19.4	4.8	690	600	142
		350	19.8	6.9	950	830	137
		<b>500</b>	<b>20.5</b>	<b>10.3</b>	<b>1340</b>	<b>1170</b>	<b>131</b>
		700	21.3	14.9	1810	1580	121
BXRA-50C1600-B-xx	5000K and 70 CRI	250	27.7	6.9	1000	870	144
		350	28.3	9.9	1370	1190	138
		<b>500</b>	<b>29.3</b>	<b>14.7</b>	<b>1930</b>	<b>1680</b>	<b>132</b>
		700	30.4	21.3	2600	2270	122
BXRA-50C2600-B-xx	5000K and 70 CRI	350	34.2	12.0	1620	1410	135
		500	35.1	17.6	2320	2020	132
		<b>700</b>	<b>36.2</b>	<b>25.3</b>	<b>3150</b>	<b>2740</b>	<b>124</b>
		1000	37.7	37.7	4330	3760	115
BXRA-56C1100-B-xx	5600K and 70 CRI	250	19.4	4.8	690	600	142
		350	19.8	6.9	950	830	137
		<b>500</b>	<b>20.5</b>	<b>10.3</b>	<b>1340</b>	<b>1170</b>	<b>131</b>
		700	21.3	14.9	1810	1580	121
BXRA-56C1600-B-xx	5600K and 70 CRI	250	27.7	6.9	1000	870	144
		350	28.3	9.9	1370	1190	138
		<b>500</b>	<b>29.3</b>	<b>14.7</b>	<b>1930</b>	<b>1680</b>	<b>132</b>
		700	30.4	21.3	2600	2270	122
BXRA-56C2600-B-xx	5600K and 70 CRI	350	34.2	12.0	1620	1410	135
		500	35.1	17.6	2320	2020	132
		<b>700</b>	<b>36.2</b>	<b>25.3</b>	<b>3150</b>	<b>2740</b>	<b>124</b>
		1000	37.7	37.7	4330	3760	115

Notes for Table 2:

9. Values in **bold** correspond to rated test currents from Table 1. Alternate values are provided for reference only and are not guaranteed.

## Flux Characteristics

Table 3: Flux Characteristics

Part Number <sup>[1]</sup>	CCT <sup>[2]</sup> (Kelvin)	CRI <sup>[3]</sup>	Test Current <sup>[5]</sup> (mA)	Minimum Flux <sup>[5]</sup> (lm)	Minimum Flux <sup>[10]</sup> (lm)	Typical Flux <sup>[6]</sup> (lm)	Typical CBCP <sup>[11]</sup> (cd)
				T <sub>j</sub> = 25°C	T <sub>case</sub> = 85°C	T <sub>case</sub> = 85°C	T <sub>j</sub> = 25°C
BXRA-27E0800-B-03	2700K	80	500	870	750	850	310
BXRA-27E1200-B-03	2700K	80	500	1250	1080	1230	450
BXRA-27E2000-B-03	2700K	80	700	2030	1770	2000	730
BXRA-27G0800-B-03	2700K	90	500	740	640	720	260
BXRA-27G1200-B-03	2700K	90	500	1060	920	1040	380
BXRA-27G2000-B-03	2700K	90	700	1780	1550	1760	640
BXRA-30E0800-B-03	3000K	80	500	950	830	930	340
BXRA-30E1200-B-03	3000K	80	500	1360	1180	1340	490
BXRA-30E2000-B-03	3000K	80	700	2170	1890	2140	780
BXRA-30G0800-B-03	3000K	90	500	800	690	780	290
BXRA-30G1200-B-03	3000K	90	500	1160	1010	1140	420
BXRA-30G2000-B-03	3000K	90	700	1850	1610	1810	660
BXRA-35E0800-B-03	3500K	80	500	1000	870	980	360
BXRA-35E1200-B-03	3500K	80	500	1440	1250	1420	520
BXRA-35E2000-B-03	3500K	80	700	2300	2000	2270	830
BXRA-40E0950-B-03	4000K	80	500	1060	920	1040	380
BXRA-40E1350-B-03	4000K	80	500	1520	1330	1500	550
BXRA-40E2200-B-03	4000K	80	700	2470	2140	2430	890
BXRA-50C1100-B-xx	5000K	70	500	1180	1030	1170	430
BXRA-50C1600-B-xx	5000K	70	500	1700	1480	1680	610
BXRA-50C2600-B-xx	5000K	70	700	2780	2420	2740	1000
BXRA-56C1100-B-xx	5600K	70	500	1180	1030	1170	430
BXRA-56C1600-B-xx	5600K	70	500	1700	1480	1680	610
BXRA-56C2600-B-xx	5600K	70	700	2780	2420	2740	1000

Notes for Table 3:

10. Minimum flux values at elevated temperatures are provided for reference only and are not guaranteed by 100% production testing. Based on Bridgelux test setup, values may vary depending on the thermal design of the luminaire and/or the environment in which the product is operated.
11. Center beam candle power is a calculated value based on a Lambertian radiation pattern at the rated test current.

## Electrical Characteristics

Table 4: Electrical Characteristics

Part Number <sup>[1]</sup>	Test Current <sup>[5]</sup> (mA)	Operating Voltage $T_j = 25^\circ\text{C}$ <sup>[5, 12]</sup> (V)			Typical Coefficient of Forward Voltage <sup>[13]</sup> (mV/°C) $\Delta V_f / \Delta T_j$	Typical Thermal Resistance Junction to Case (°C/W) $R_{\theta j-c}$
		Minimum	Typical	Maximum		
BXRA-27E0800-B-03	500	18.4	20.5	22.5	-7 to -21	0.95
BXRA-27E1200-B-03	500	26.3	29.3	32.2	-10 to -30	0.80
BXRA-27E2000-B-03	700	32.6	36.2	39.8	-12 to -36	0.65
BXRA-27G0800-B-03	500	18.4	20.5	22.5	-7 to -21	0.95
BXRA-27G1200-B-03	500	26.3	29.3	32.2	-10 to -30	0.80
BXRA-27G2000-B-03	700	32.6	36.2	39.8	-12 to -36	0.65
BXRA-30E0800-B-03	500	18.4	20.5	22.5	-7 to -21	0.95
BXRA-30E1200-B-03	500	26.3	29.3	32.2	-10 to -30	0.80
BXRA-30E2000-B-03	700	32.6	36.2	39.8	-12 to -36	0.65
BXRA-30G0800-B-03	500	18.4	20.5	22.5	-7 to -21	0.95
BXRA-30G1200-B-03	500	26.3	29.3	32.2	-10 to -30	0.80
BXRA-30G2000-B-03	700	32.6	36.2	39.8	-12 to -36	0.65
BXRA-35E0800-B-03	500	18.4	20.5	22.5	-7 to -21	0.95
BXRA-35E1200-B-03	500	26.3	29.3	32.2	-10 to -30	0.80
BXRA-35E2000-B-03	700	32.6	36.2	39.8	-12 to -36	0.65
BXRA-40E0950-B-03	500	18.4	20.5	22.5	-7 to -21	0.95
BXRA-40E1350-B-03	500	26.3	29.3	32.2	-10 to -30	0.80
BXRA-40E2200-B-03	700	32.6	36.2	39.8	-12 to -36	0.65
BXRA-50C1100-B-xx	500	18.4	20.5	22.5	-7 to -21	0.95
BXRA-50C1600-B-xx	500	26.3	29.3	32.2	-10 to -30	0.80
BXRA-50C2600-B-xx	700	32.6	36.2	39.8	-12 to -36	0.65
BXRA-56C1100-B-xx	500	18.4	20.5	22.5	-7 to -21	0.95
BXRA-56C1600-B-xx	500	26.3	29.3	32.2	-10 to -30	0.80
BXRA-56C2600-B-xx	700	32.6	36.2	39.8	-12 to -36	0.65

Notes for Table 4:

12. Bridgelux maintains a tester tolerance of  $\pm 0.10$  V on forward voltage measurements. Voltage minimum and maximum values at the rated test current are guaranteed by 100% test.
13. Typical Coefficient of Forward Voltage maintains a tolerance of  $\pm 0.1$  from nominal current.

## Absolute Maximum Ratings

Table 5: Maximum Current and Reverse Voltage Ratings

CCT <sup>[2]</sup> (Kelvin)	Part Number <sup>[1]</sup>	DC Forward Current for LM-80 (mA) <sup>[4,5,6]</sup>	Maximum Peak Pulsed Current (mA) <sup>[14, 16]</sup>	Maximum Reverse Voltage (Vr) <sup>[15]</sup>
2700K	BXRA-27E0800-B-03	1000	1400	-35
	BXRA-27G0800-B-03	1000	1400	-35
	BXRA-27E1200-B-03	1000	1400	-50
	BXRA-27G1200-B-03	1000	1400	-50
	BXRA-27E2000-B-03	1000	1400	-60
	BXRA-27G2000-B-03	1000	1400	-60
3000K	BXRA-30E0800-B-03	1000	1400	-35
	BXRA-30G0800-B-03	1000	1400	-35
	BXRA-30E1200-B-03	1000	1400	-50
	BXRA-30G1200-B-03	1000	1400	-50
	BXRA-30E2000-B-03	1000	1400	-60
	BXRA-30G2000-B-03	1000	1400	-60
3500K	BXRA-35E0800-B-03	1000	1400	-35
	BXRA-35E1200-B-03	1000	1400	-50
	BXRA-35E2000-B-03	1000	1400	-60
4000K	BXRA-40E0950-B-03	1000	1400	-35
	BXRA-40E1350-B-03	1000	1400	-50
	BXRA-40E2200-B-03	1000	1400	-60
5000K	BXRA-50C1100-B-xx	1000	1400	-35
	BXRA-50C1600-B-xx	1000	1400	-50
	BXRA-50C2600-B-xx	1000	1400	-60
5600K	BXRA-56C1100-B-xx	1000	1400	-35
	BXRA-56C1600-B-xx	1000	1400	-50
	BXRA-56C2600-B-xx	1000	1400	-60

Notes for Table 5:

14. Bridgelux recommends a maximum duty cycle of 10% when operating LED Arrays at the maximum peak pulsed current specified.
15. Light emitting diodes are not designed to be driven in reverse voltage.
16. Maximum peak pulsed currents are values at which the LED Array can be driven without catastrophic failures.
17. DC Forward Current for LM-80 are the maximum drive currents for which LM-80 data is currently available
18. Lumen maintenance (L70) and lifetime predictions are valid for drive current and case temperature conditions used for LM-80 testing as included in the applicable LM-80 test report for these arrays.
19. Arrays can be driven at higher currents but lumen maintenance may be reduced

---

Table 6: Maximum Ratings

Parameter	Maximum Rating
LED Junction Temperature	150°C
Storage Temperature	-40°C to +105°C
Operating Case Temperature	105°C
Soldering Temperature <sup>[1]</sup>	350°C or lower for a maximum of 3.5 seconds

Note for Table 6:

20. Refer to Bridgelux Application Note AN15: Reflow soldering of Bridgelux LED Arrays for solder procedure ([www.Bridgelux.com](http://www.Bridgelux.com))

## Forward Current Characteristics

Figure 2: Typical Current vs. Voltage

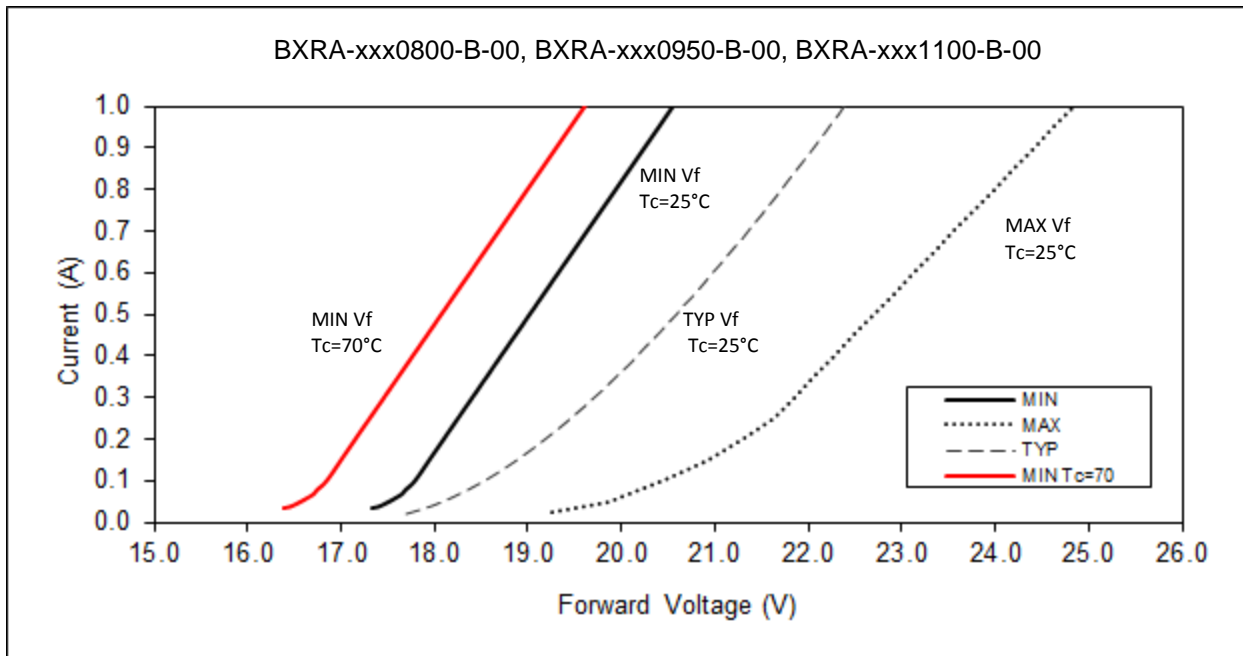
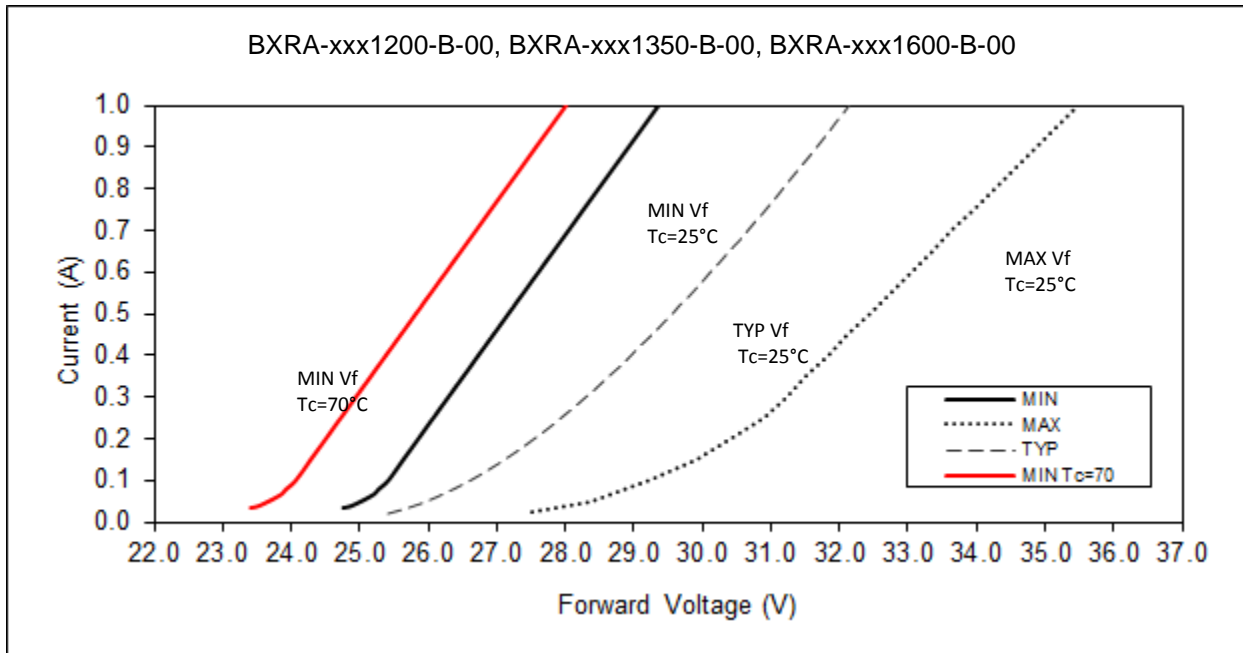
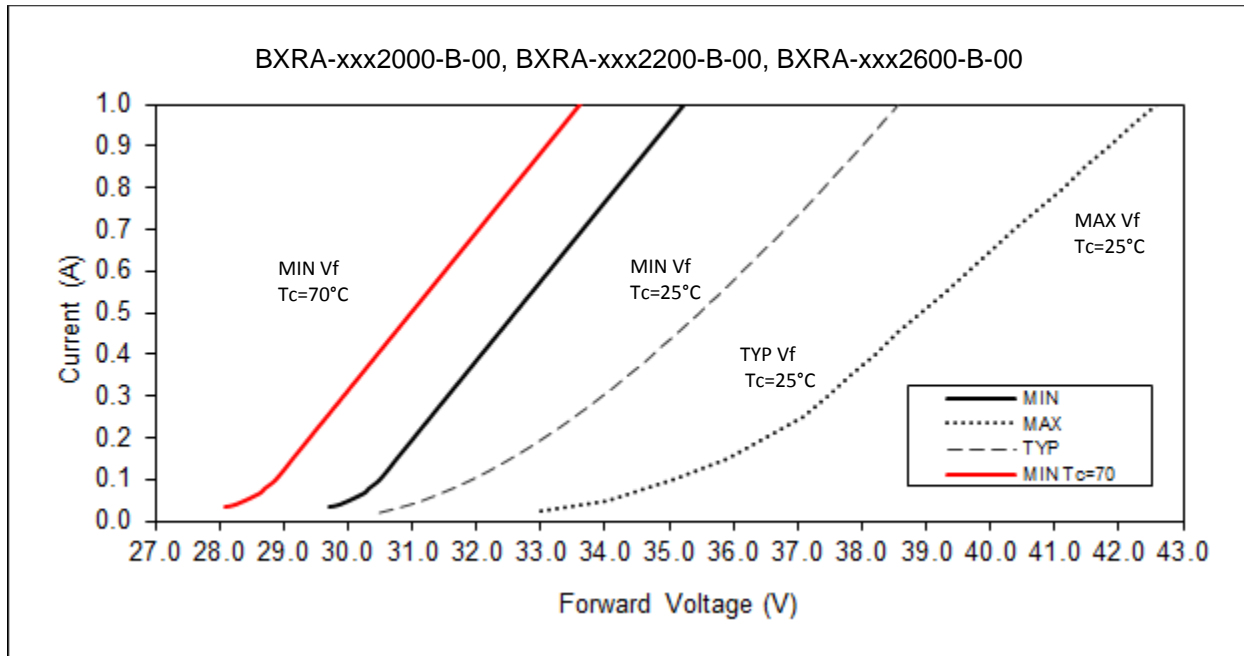

Figure 3: Typical Current vs. Voltage



Forward Current Characteristics (continued)

Figure 4: Typical Current vs. Voltage



---

## Typical Relative Luminous Flux vs. Current

Typical performance at any drive current can be derived from the current versus voltage characteristics shown in Figures 2, 3, and 4 and the flux versus current characteristics shown in Figures 5 and 6. Figure 5 and 6 represent typical performance when pulsed at a junction temperature of 25 degrees Celsius.

Figure 5: Typical Flux vs. Current

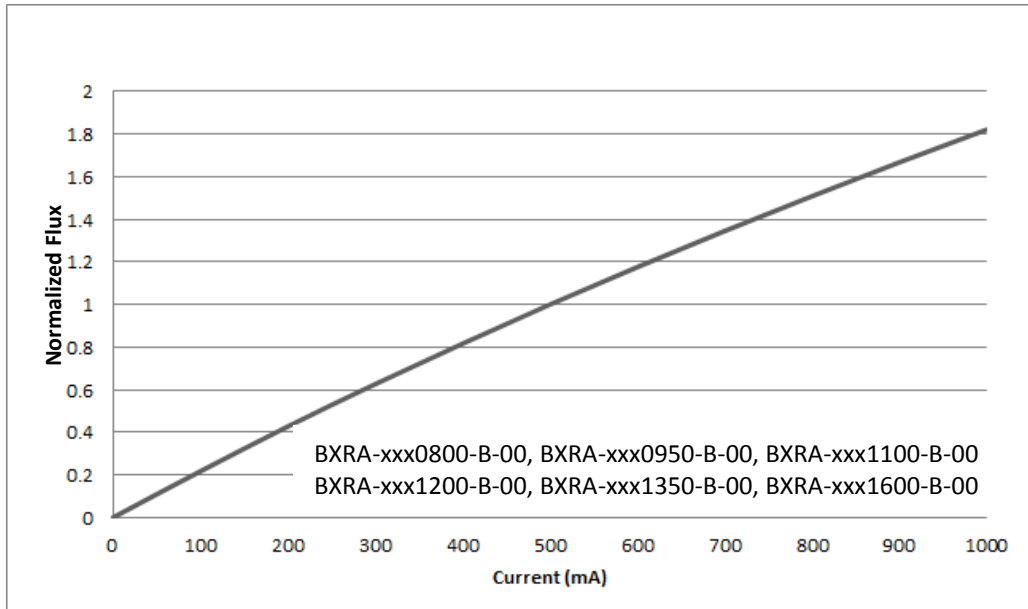
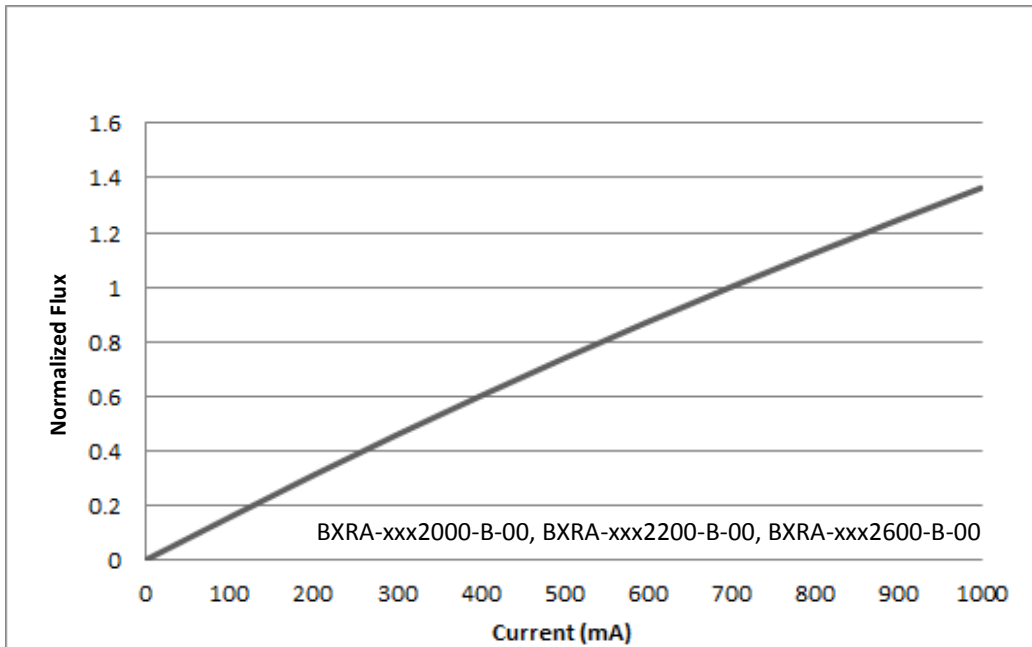

Figure 6: Typical Flux vs. Current



## Typical Chromaticity Characteristics (continued)



Figure 7: Typical Flux vs. Junction Temperature

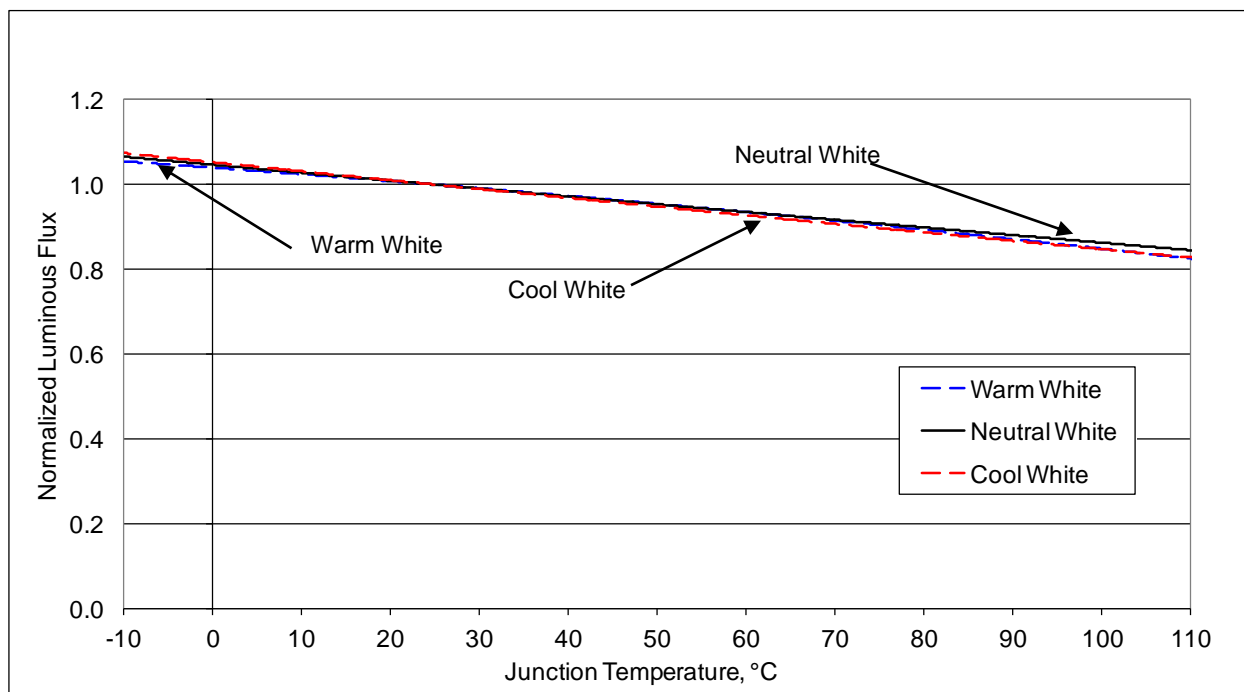

Note for Figures 7, 8 and 9:

1. Characteristics shown for Warm White 3000K 80CRI
2. Characteristics shown for Neutral White 4000K 80CRI
3. Characteristics shown for Neutral White 5000K 70CRI

Typical Chromaticity Characteristics (continued)

Figure 8: Typical Flux vs. Junction Temperature

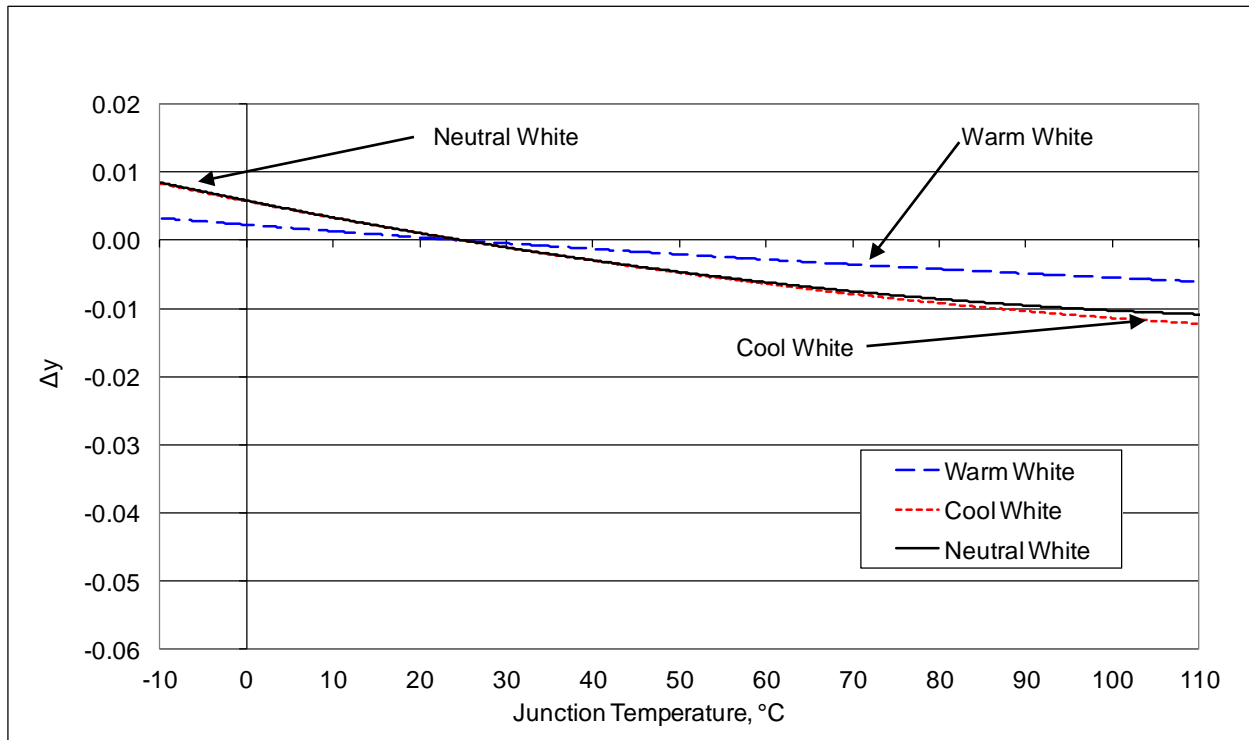
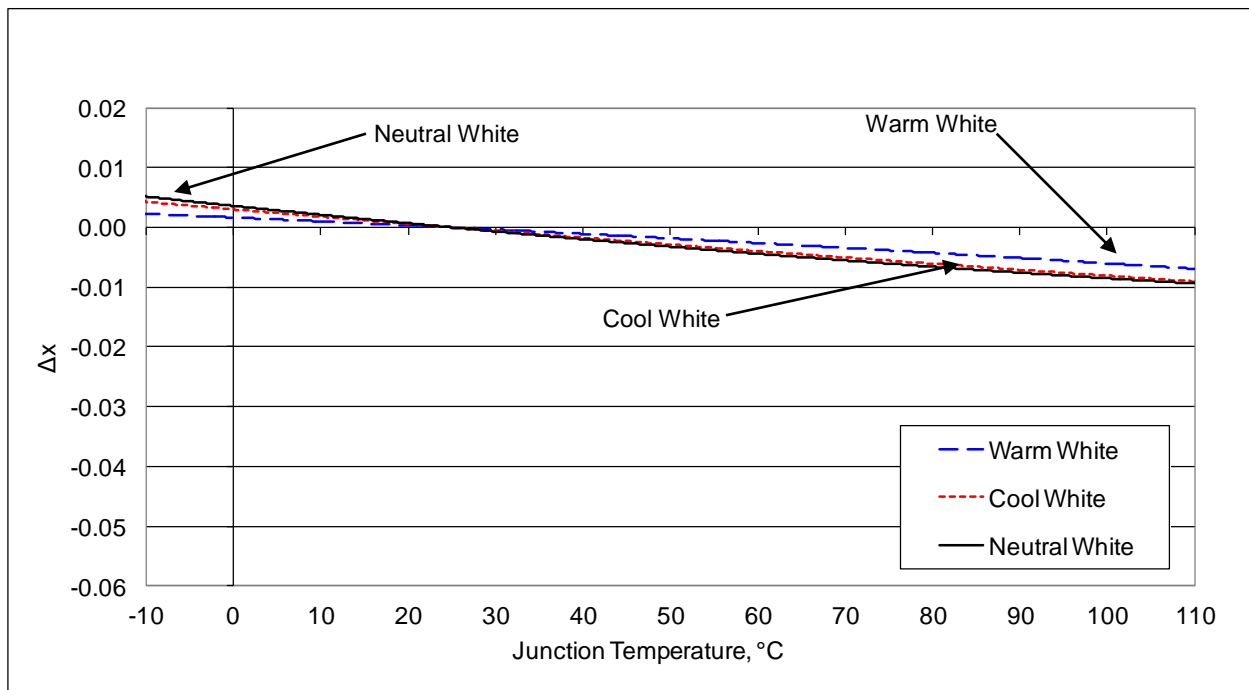
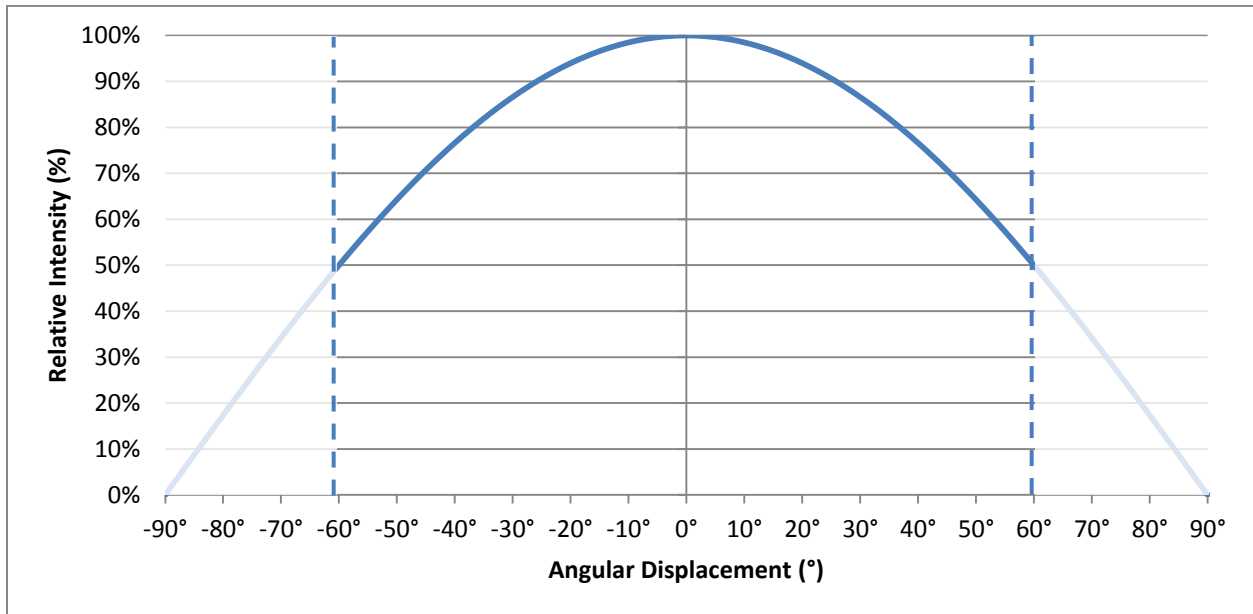

Figure 9: Typical Flux vs. Junction Temperature



## Typical Radiation Pattern

Figure 10: Typical Spatial Radiation Pattern



Notes for figure 10:

1. Typical viewing angle is  $120^\circ$
2. Viewing angle is defined as the off axis angle from the centerline where vertical intensity is  $\frac{1}{2}$  of the peak intensity value.

Figure 11: Typical Polar Radiation Pattern

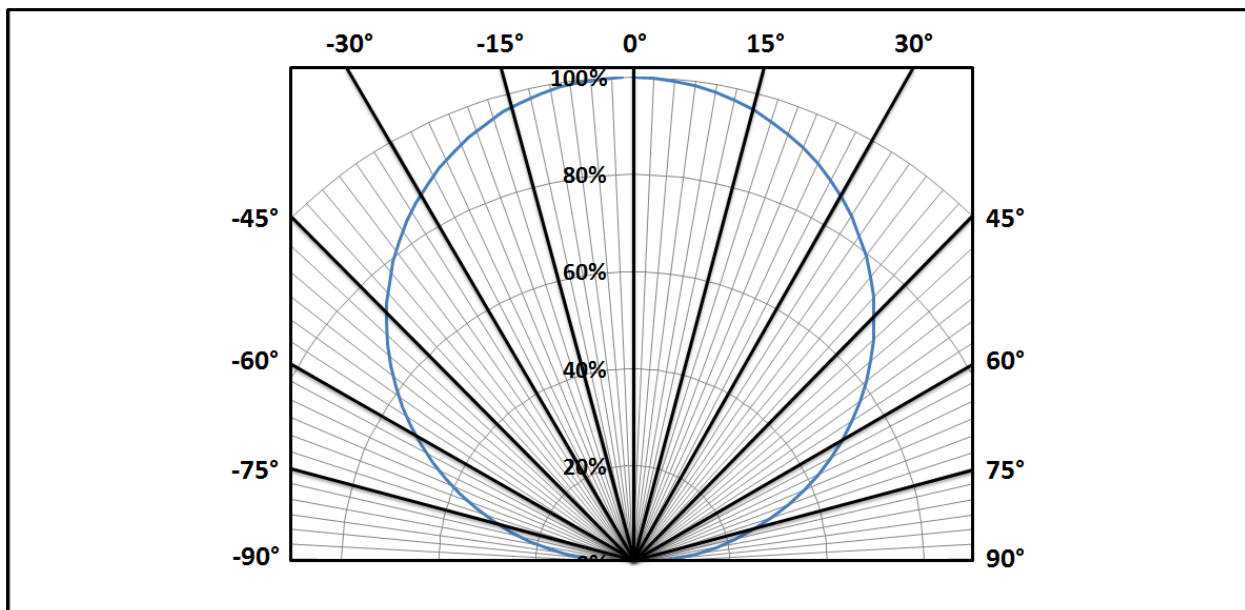

## Typical Spectral Characteristics

Figure 12: Typical Color Spectrum

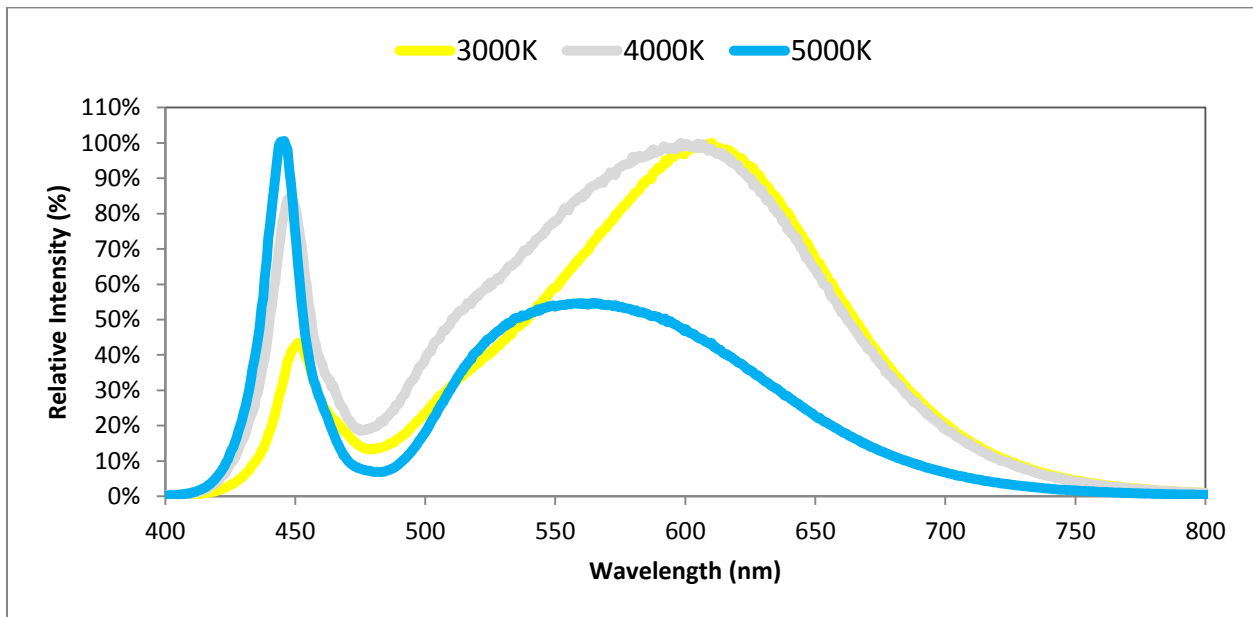

Notes for Figure 12:

1. Color spectra measured at rated current and  $T_j = 25^\circ\text{C}$ .
2. Color spectrum shown for warm white is 3000K and 80 CRI.
3. Color spectrum shown for neutral white is 4000K and 80 CRI.
4. Color spectrum shown for cool white is 5000K and 70 CRI.

## Mechanical Dimensions

Figure 13: Drawing for ES Rectangular Arrays

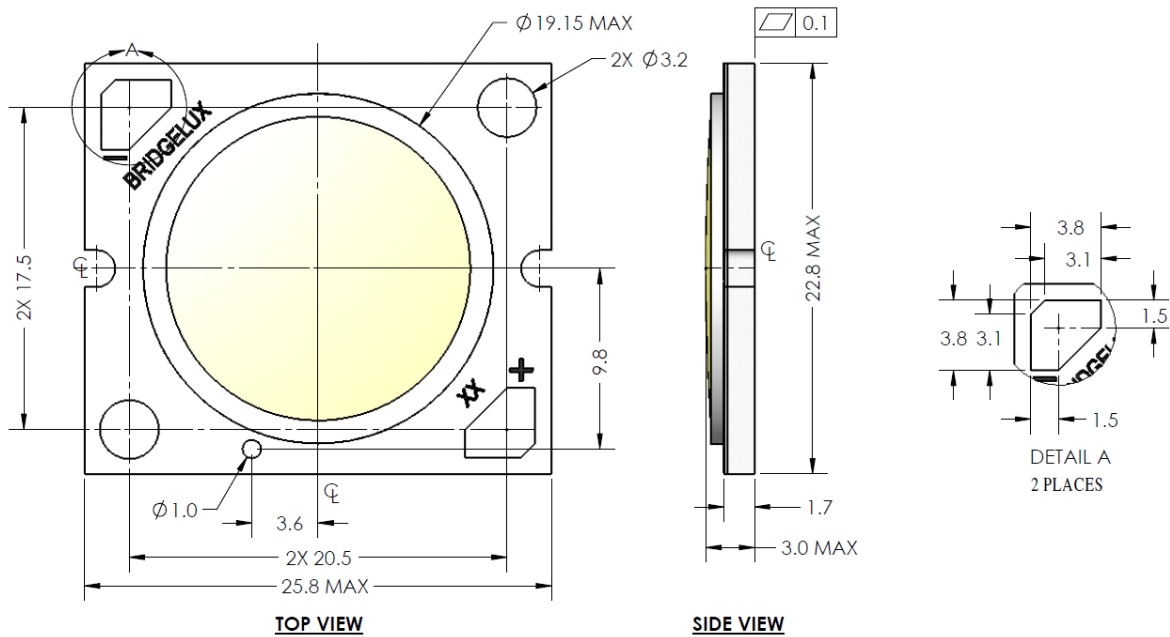

### Notes for Figure 13:

1. Mounting holes are for M2.5 or #4 screws.
2. Solder pads are labeled "+" and "-" to denote positive and negative, respectively.
3. It is not necessary to provide electrical connections to both sets of solder pads. Either set may be used depending on application specific design requirements.
4. Drawings are not to scale.
5. Drawing dimensions are in millimeters.
6. Unless otherwise specified, tolerances are  $\pm 0.10$ mm.
7. The optical center of the LED Array is nominally defined by the mechanical center of the array. The light emitting surface (LES) is centered on the mechanical center of the array to a tolerance of  $\pm 0.45$  mm
8. Bridgelux maintains a flatness of 0.1 mm across the mounting surface of the array. Refer to Application Notes AN10 and AN11 for product handling, mounting and heat sink recommendations.

## Color Binning Information

Figure 14: Graph of Warm White Test Bins in xy Color Space

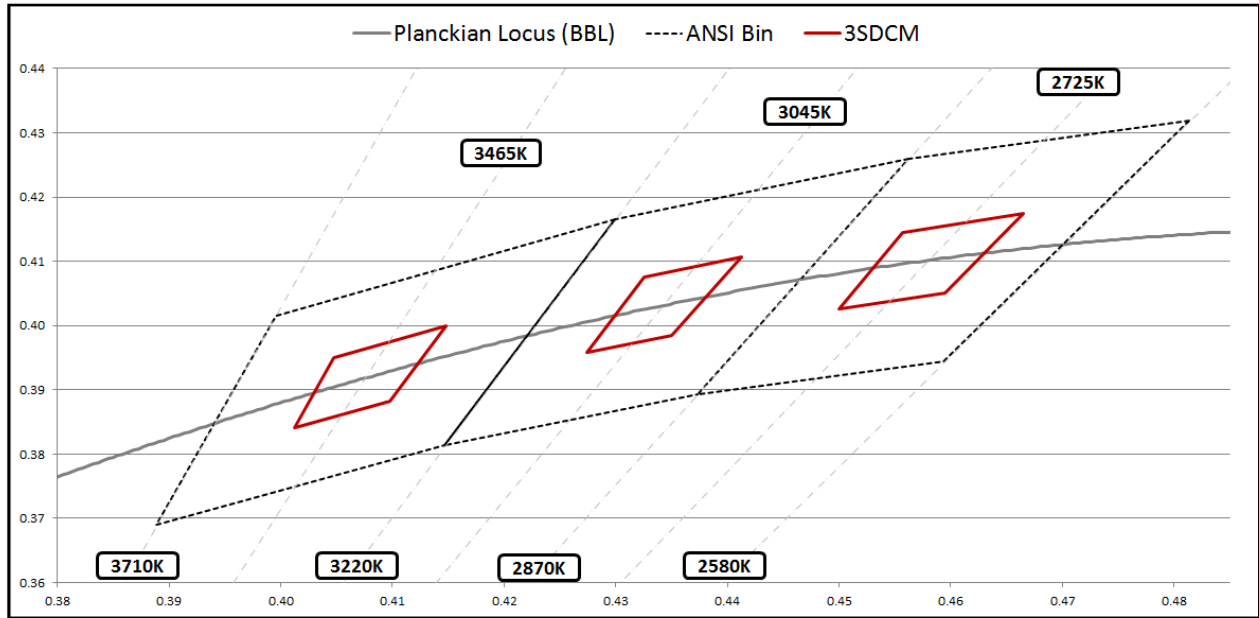

Note: 3SDCM bins are shown inside standard ANSI bins for comparison purposes.

Table 7: Warm White xy Bin Coordinates and Associated Typical CCT

Bin Code	x	y	CCT (K)
X3 (3SDCM)	0.4148	0.4000	3500
	0.4047	0.3950	
	0.4012	0.3841	
	0.4098	0.3883	
	0.4148	0.4000	

Bin Code	x	y	CCT (K)
X3 (3SDCM)	0.4413	0.4107	3000
	0.4325	0.4075	
	0.4274	0.3958	
	0.4350	0.3984	
	0.4413	0.4107	

Bin Code	x	y	CCT (K)
X3 (3SDCM)	0.4665	0.4175	2700
	0.4557	0.4145	
	0.4500	0.4026	
	0.4595	0.4050	
	0.4665	0.4175	

Color Binning Information (continued)

Figure 15: Graph of Neutral White Test Bins in xy Color Space

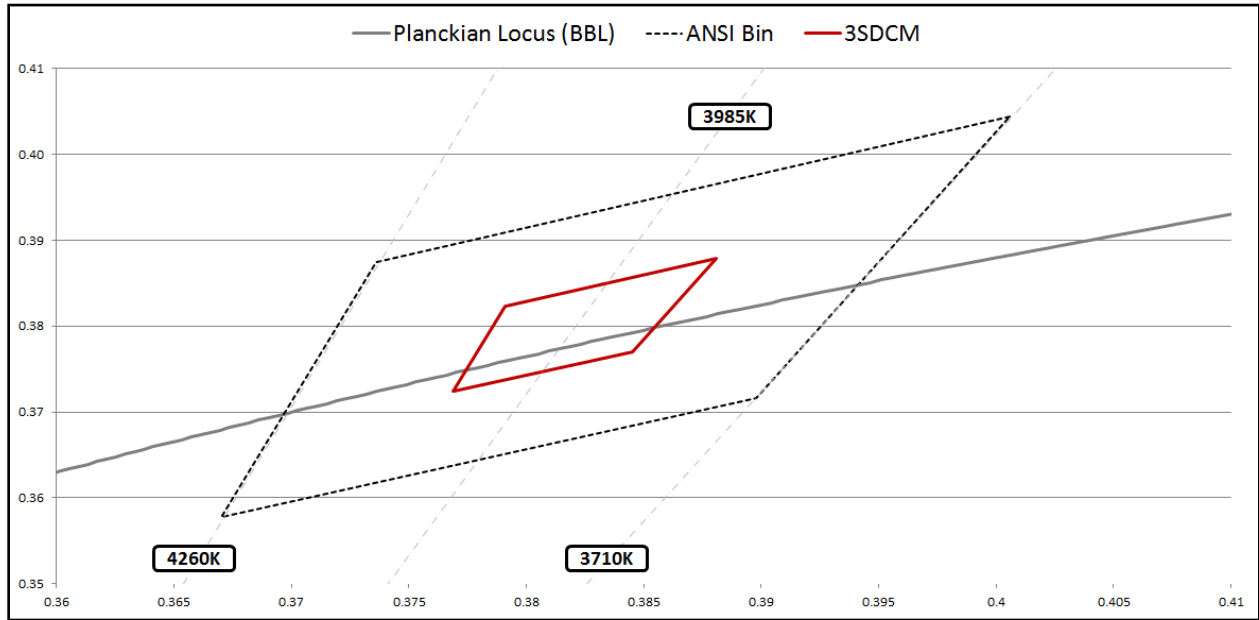

Note: 3SDCM bins are shown inside standard ANSI bins for comparison purposes.

Table 8: Neutral White xy Bin Coordinates and Associated Typical CCT

Bin Code	X	Y	CCT (K)
X3 3SDCM	0.3881 0.3791 0.3769 0.3845	0.3879 0.3823 0.3724 0.377	4000

Color Binning Information (continued)

Figure 16: Graph of Cool White Test Bins in xy Color Space

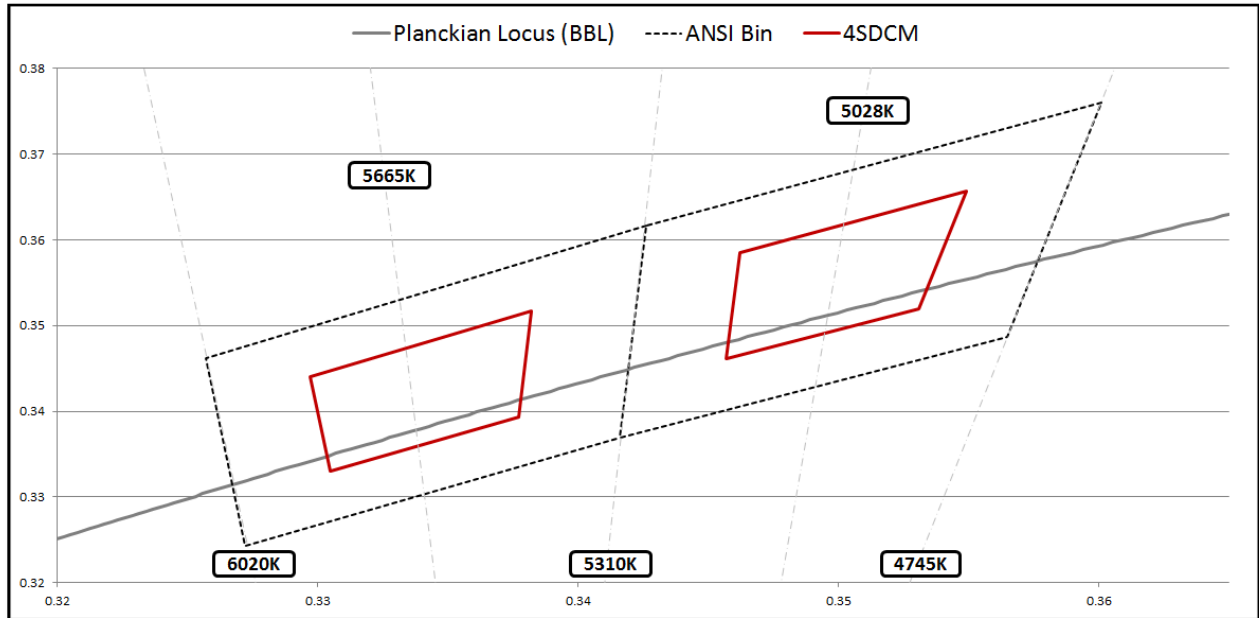

Note: 4SDCM bins are shown inside standard ANSI bins for comparison purposes.

Table 9: Cool White xy Bin Coordinates and Associated Typical CCT

Bin Code	X	Y	ANSI CCT (K)	Bin Code	X	Y	ANSI CCT (K)
G3	0.3376	0.3616	5000	E3	0.3215	0.3353	5600
	0.3464	0.3688			0.3293	0.3423	
	0.3452	0.3558			0.3292	0.3539	
	0.3371	0.3493			0.3207	0.3462	
G4	0.3371	0.3493	5000	E4	0.3222	0.3243	5600
	0.3452	0.3558			0.3294	0.3306	
	0.3441	0.3428			0.3293	0.3423	
	0.3366	0.3369			0.3215	0.3353	
H3	0.3464	0.3688	5000	F3	0.3292	0.3539	5600
	0.3551	0.376			0.3293	0.3423	
	0.3533	0.3624			0.3371	0.3493	
	0.3452	0.3558			0.3376	0.3616	



H4	0.3452	0.3558	5000
	0.3533	0.3624	
	0.3515	0.3487	
	0.3441	0.3428	
X4 (4SDCM)	0.3499	0.3657	5000
	0.3412	0.3585	
	0.3407	0.3461	
	0.3481	0.3520	

F4	0.3294	0.3306	5600
	0.3366	0.3369	
	0.3371	0.3493	
	0.3293	0.3423	
X4 (4SDCM)	0.3332	0.3517	5600
	0.3247	0.3440	
	0.3255	0.3330	
	0.3327	0.3393	

## Color Control Options

ES LED Series Arrays are available in the following color control options.

Table 10: Color Control Options

Product	CCT	CRI	3SDCM Part Number	4SDCM Part Number	7SDCM Part Number
ES LED Array	2700K	80	BXRA-27E0800-B-03	Not Available	Not Available
ES LED Array	2700K	90	BXRA-27G0800-B-03	Not Available	Not Available
ES LED Array	2700K	80	BXRA-27E1200-B-03	Not Available	Not Available
ES LED Array	2700K	90	BXRA-27G1200-B-03	Not Available	Not Available
ES LED Array	2700K	80	BXRA-27E2000-B-03	Not Available	Not Available
ES LED Array	2700K	90	BXRA-27G2000-B-03	Not Available	Not Available
ES LED Array	3000K	80	BXRA-30E0800-B-03	Not Available	Not Available
ES LED Array	3000K	90	BXRA-30G0800-B-03	Not Available	Not Available
ES LED Array	3000K	80	BXRA-30E1200-B-03	Not Available	Not Available
ES LED Array	3000K	90	BXRA-30G1200-B-03	Not Available	Not Available
ES LED Array	3000K	80	BXRA-30E2000-B-03	Not Available	Not Available
ES LED Array	3000K	90	BXRA-30G2000-B-03	Not Available	Not Available
ES LED Array	3500K	80	BXRA-35E0800-B-03	Not Available	Not Available
ES LED Array	3500K	80	BXRA-35E1200-B-03	Not Available	Not Available
ES LED Array	3500K	80	BXRA-35E2000-B-03	Not Available	Not Available
ES LED Array	4000K	80	BXRA-40E0950-B-03	Not Available	Not Available
ES LED Array	4000K	80	BXRA-40E1350-B-03	Not Available	Not Available
ES LED Array	4000K	80	BXRA-40E2200-B-03	Not Available	Not Available
ES LED Array	5000K	70	Not Available	BXRA-50C1100-B-04	BXRA-50C1100-B-00
ES LED Array	5000K	70	Not Available	BXRA-50C1600-B-04	BXRA-50C1600-B-00
ES LED Array	5000K	70	Not Available	BXRA-50C2600-B-04	BXRA-50C2600-B-00
ES LED Array	5600K	70	Not Available	BXRA-56C1100-B-04	BXRA-56C1100-B-00
ES LED Array	5600K	70	Not Available	BXRA-56C1600-B-04	BXRA-56C1600-B-00
ES LED Array	5600K	70	Not Available	BXRA-56C2600-B-04	BXRA-56C2600-B-00

### Note: Color Control Marking

Array part numbers are shown in the tables above. Arrays are tested, binned and marked with the appropriate sub-bin.

Warm and Neutral White arrays are tested to 3SDCM (marked as X3).

Cool white arrays are tested to 4SDCM (marked as X4).

Cool white arrays are tested to 7SDCM (marked with sub-bin).

---

## Design Resources

Bridgelux has developed a comprehensive set of application notes and design resources to assist customers in successfully designing with Bridgelux LED Array products. Included below is a list of available resources which can be downloaded from the Bridgelux web site under the Design Resources section. These documents are updated regularly as new information becomes available, including complimentary infrastructure products such as commercially available secondary optics and electronic driver solutions.

### Application Notes

- AN10: Effective Thermal Management of Bridgelux LED Arrays
- AN11: Assembly Considerations for Bridgelux LED Arrays
- AN12: Electrical Drive Considerations for Bridgelux LED Arrays
- AN14: Reliability Data Sheet for Bridgelux LED Arrays
- AN15: Reflow Soldering of Bridgelux LED Arrays
- AN16: Optical Considerations for Bridgelux LED Arrays

### Optical Source Models

Optical source models and ray set files are available for all Bridgelux LED Array products, and can be downloaded directly from the Bridgelux web site. The list below contains the formats currently available. If you require a specific format not included in this list, please contact your Bridgelux sales representative for assistance.

- Zemax
- ASAP
- IESNA
- LightTools
- LucidShape
- OPTIS SPEOS
- PHOTOPIA
- TracePro
- Radiant Imaging Source Model

### 3D CAD Models

Three dimensional CAD models depicting the product outline of all Bridgelux LED Arrays are available in both SAT and STEP formats. These CAD files can be downloaded directly from the Bridgelux web site.

---

## About Bridgelux

Bridgelux is a leading developer and manufacturer of technologies and solutions transforming the \$40 billion global lighting industry into a \$100 billion market opportunity. Based in Livermore, California, Bridgelux is a pioneer in solid-state lighting (SSL), expanding the market for light-emitting diode (LED) technologies by driving down the cost of LED lighting systems. Bridgelux's patented light source technology replaces traditional technologies (such as incandescent, halogen, fluorescent and high intensity discharge lighting) with integrated, solid-state lighting solutions that enable lamp and luminaire manufacturers to provide high performance and energy-efficient white light for the rapidly growing interior and exterior lighting markets, including street lights, commercial lighting and consumer applications. With more than 650 patent applications filed or granted worldwide, Bridgelux is the only vertically integrated LED manufacturer and developer of solid-state light sources that designs its solutions specifically for the lighting industry.

For more information about the company, please visit [www.bridgelux.com](http://www.bridgelux.com)



© 2013 Bridgelux, Inc. All rights reserved. Product specifications are subject to change without notice.