

**Battrax® Series - Single Port Negative - MS-013**

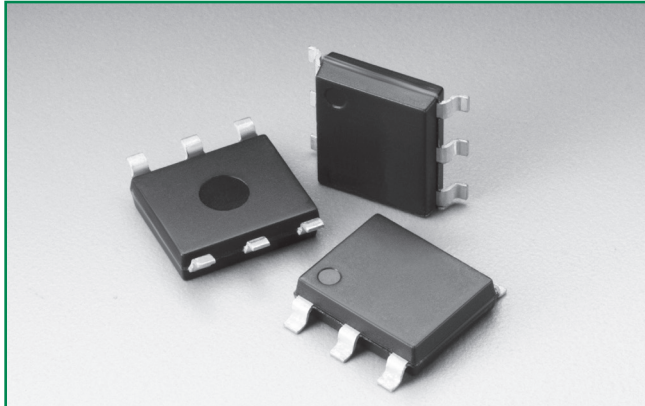

**Agency Approvals**

| Agency | Agency File Number |
|--------|--------------------|
|        | E133083            |

**Pinout Designation**

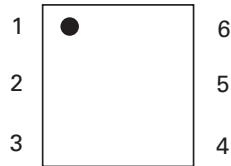

**Schematic Symbol**

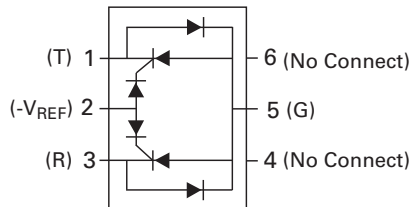

**Electrical Characteristics**

| Part Number | Marking | $V_{DRM}$<br>@ $I_{DRM} = 5\mu A$ | $V_S$<br>@ 100V/ $\mu s$ | $I_H$  | $I_S$  | $I_T$ | $V_T$<br>@ $I_T = 2.2$ Amps | $V_F$ | Capacitance* |        |
|-------------|---------|-----------------------------------|--------------------------|--------|--------|-------|-----------------------------|-------|--------------|--------|
|             |         | V min                             | V max                    | mA min | mA max | A max | V max                       | V max | pF min       | pF max |
| B1101UALxx  | B1101UA | $-V_{REF}   + I - 1.2V_I$         | $-V_{REF}   + I - 10V_I$ | 100    | 100    | 2.2   | 4                           | 5     | 30           | 200    |
| B1161UALxx  | B1161UA | $-V_{REF}   + I - 1.2V_I$         | $-V_{REF}   + I - 10V_I$ | 160    | 100    | 2.2   | 4                           | 5     | 30           | 200    |
| B1201UALxx  | B1201UA | $-V_{REF}   + I - 1.2V_I$         | $-V_{REF}   + I - 10V_I$ | 200    | 100    | 2.2   | 4                           | 5     | 30           | 200    |
| B1101UCLxx  | B1101UC | $-V_{REF}   + I - 1.2V_I$         | $-V_{REF}   + I - 10V_I$ | 100    | 100    | 2.2   | 4                           | 5     | 30           | 200    |
| B1161UCLxx  | B1161UC | $-V_{REF}   + I - 1.2V_I$         | $-V_{REF}   + I - 10V_I$ | 160    | 100    | 2.2   | 4                           | 5     | 30           | 200    |
| B1201UCLxx  | B1201UC | $-V_{REF}   + I - 1.2V_I$         | $-V_{REF}   + I - 10V_I$ | 200    | 100    | 2.2   | 4                           | 5     | 30           | 200    |

Notes:  
 - Absolute maximum ratings measured at  $T_J = 25^\circ C$  (unless otherwise noted).  
 - Components are not appropriate for positive ringing systems.  
 - All electrical characteristics shown are defined from Tip (pin 1) to Ground (pin 5), and Ring (pin 3) to Ground (pin 5)

**Description**

The Battrax® Protection Thyristor series offers programmable SIDACtor® overvoltage protection components for SLIC applications. The Single Port Negative Battrax® Protection Thyristor series provides a programmable device that is referenced to a negative voltage source while internal diodes provide protection from positive surge events.

**Features and Benefits**

- Low voltage overshoot device
- Low on-state voltage
- Does not degrade surge capability after multiple surge events within limit.
- Fails short circuit when surged in excess of ratings
- Single-port protection
- Gate triggered tracking
- Integrated diodes for positive voltage protection
- Pb-free E3 means 2nd level interconnect is Pb-free and the terminal finish material is tin(Sn) (IPC/JEDEC J-STD-609A.01)
- RoHS compliant and lead-free

**Applicable Global Standards**

- TIA-968-A
- TIA-968-B
- ITU K.20/21 Enhanced Level
- ITU K.20/21 Basic Level
- GR 1089 Intra-building
- IEC 61000-4-5 2nd edition
- YD/T 1082
- YD/T 993
- YD/T 950

**Additional Information**



Datasheet



Resources



Samples

Battrax® Single Port Neg Series

-  $V_{REF}$  Max Value for the negative Battrax is -200 V.  
 - **XX** = Part Number Suffix: **TP** (Tube Pack) or **RP** (Reel Pack).  
 \* Off-state capacitance ( $C_o$ ) is measured across pins 1 & 5 and 3 & 5 at 1 MHz with a 2V bias.

**Surge Ratings**

| Series | $I_{PP}$                                     |  |  |  |  |  |  |  |   | $I_{TSM}$<br>50/60 Hz | di/dt |
|--------|--|--|--|--|--|--|--|--|---|-----------------------|-------|
|        | 0.2/310 <sup>1</sup><br>0.5/700 <sup>2</sup> | 2/10 <sup>1</sup><br>2/10 <sup>2</sup> | 8/20 <sup>1</sup><br>1.2/50 <sup>2</sup> | 10/160 <sup>1</sup><br>10/160 <sup>2</sup> | 10/560 <sup>1</sup><br>10/560 <sup>2</sup> | 5/320 <sup>1</sup><br>9/720 <sup>2</sup> | 10/360 <sup>1</sup><br>10/360 <sup>2</sup> | 10/1000 <sup>1</sup><br>10/1000 <sup>2</sup> | 5/310 <sup>1</sup><br>10/700 <sup>2</sup> |                       |       |
|        | A min  | A min                                  | A min                                    | A min                                      | A min                                      | A min                                    | A min                                      | A min  | A min                                     |                       |       |
| A      | 20   | 150                                    | 150                                      | 90   | 50   | 75                                       | 75   | 45   | 75  | 20                    | 500   |
| C      | 50   | 500                                    | 400                                      | 200  | 150  | 200                                      | 175  | 100  | 200                                       | 50                    | 500   |

Notes:  
 1 Current waveform in  $\mu s$   
 2 Voltage waveform in  $\mu s$   
 - Peak pulse current rating ( $I_{PP}$ ) is repetitive and guaranteed for the life of the product that remains in thermal equilibrium.  
 -  $I_{PP}$  ratings applicable over temperature range of  $-40^{\circ}C$  to  $+85^{\circ}C$  ( $I_{PP}$  rating assumes  $V_{REF}$  equals  $-48 V$ )  
 - The component must initially be in thermal equilibrium with  $-40^{\circ}C \leq T_J \leq +150^{\circ}C$

**Thermal Considerations**

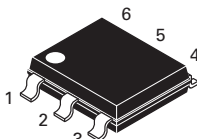
| Package  | Symbol          | Parameter                               | Value       | Unit          |
|--|-----------------|---|-------------|---------------|
| Modified MS-013<br> | $T_J$           | Operating Junction Temperature Range    | -40 to +125 | $^{\circ}C$   |
|  | $T_S$           | Storage Temperature Range               | -65 to +150 | $^{\circ}C$   |
|  | $R_{\theta JA}$ | Thermal Resistance: Junction to Ambient | 60          | $^{\circ}C/W$ |

**V-I Characteristics**

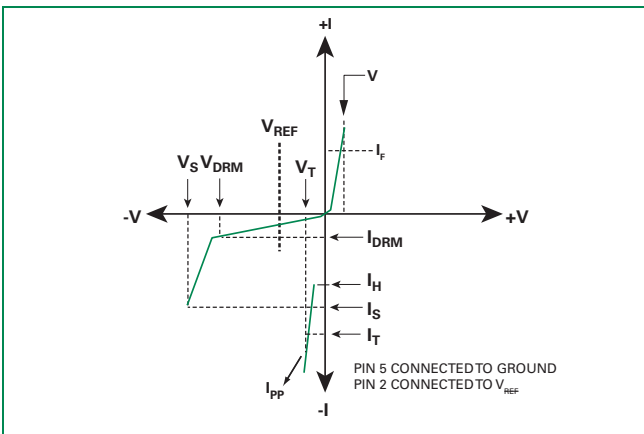

**$t_r \times t_d$  Pulse Waveform**

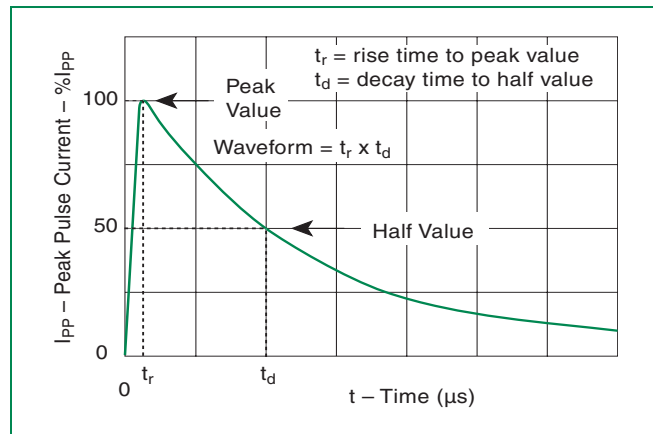

**Normalized  $V_S$  Change vs. Junction Temperature**

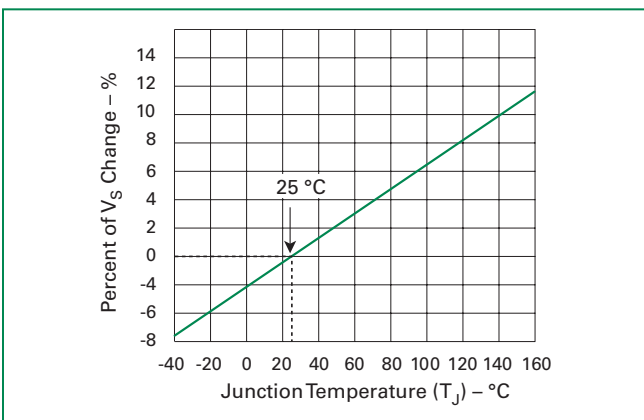

**Normalized DC Holding Current vs. Case Temperature**

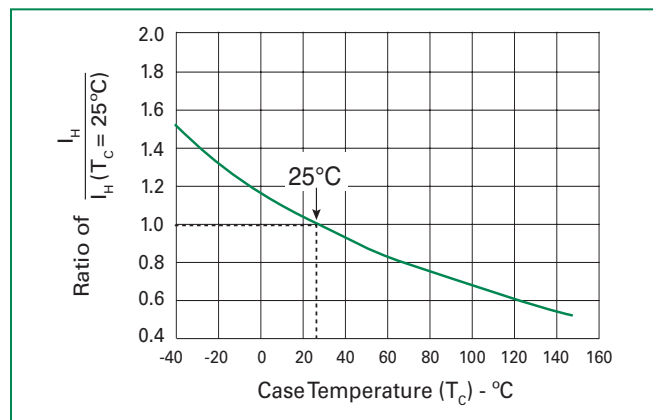

### Soldering Parameters

|  |                                   |              |
|--|-----------------------------------|--------------|
| Reflow Condition                                       | Pb-Free assembly (see Fig. 1)     |              |
| Pre Heat   | -Temperature Min ( $T_{s(min)}$ ) | +150°C       |
|  | -Temperature Max ( $T_{s(max)}$ ) | +200°C       |
|  | -Time (Min to Max) ( $t_s$ )      | 60-180 secs. |
| Average ramp up rate (Liquidus Temp ( $T_L$ ) to peak) | 3°C/sec. Max.                     |              |
| $T_{s(max)}$ to $T_L$ - Ramp-up Rate                   | 3°C/sec. Max.                     |              |
| Reflow   | -Temperature ( $T_L$ ) (Liquidus) | +217°C       |
|  | -Temperature ( $t_L$ )            | 60-150 secs. |
| Peak Temp ( $T_p$ )                                    | +260(+0/-5)°C                     |              |
| Time within 5°C of actual Peak Temp ( $t_p$ )          | 30 secs. Max.                     |              |
| Ramp-down Rate   | 6°C/sec. Max.                     |              |
| Time 25°C to Peak Temp ( $T_p$ )                       | 8 min. Max.                       |              |
| Do not exceed  | +260°C                            |              |

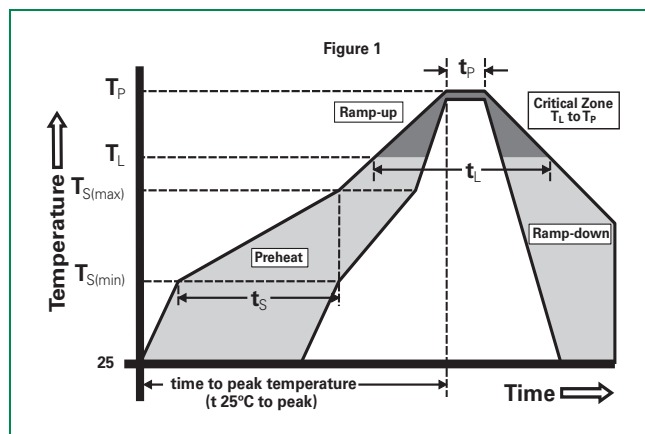

### Physical Specifications

|                 |   |
|-----------------|---|
| Lead Material   | Copper Alloy  |
| Terminal Finish | 100% Matte-Tin Plated                                       |
| Body Material   | UL Recognized epoxy meeting flammability classification V-0 |

### Environmental Specifications

|                                  |  |
|----------------------------------|--|
| High Temp Voltage Blocking       | 80% Rated $V_{REF}$ Max. ( $V_{DC}$ Peak) +125°C or +150°C, 504 or 1008 hrs. MIL-STD-750 (Method 1040) JEDEC, JESD22-A-101 |
| Temp Cycling                     | -65°C to +150°C, 15 min. dwell, 10 up to 100 cycles. MIL-STD-750 (Method 1051) EIA/JEDEC, JESD22-A104                      |
| Biased Temp & Humidity           | 52 $V_{DC}$ (+85°C) 85% RH, 504 up to 1008 hrs. EIA/JEDEC, JESD22-A-101  |
| High Temp Storage                | +150°C 1008 hrs. MIL-STD-750 (Method 1031) JEDEC, JESD22-A-101   |
| Low Temp Storage                 | -65°C, 1008 hrs.   |
| Thermal Shock                    | 0°C to +100°C, 5 min. dwell, 10 sec. transfer, 10 cycles. MIL-STD-750 (Method 1056) JEDEC, JESD22-A-106                    |
| Autoclave (Pressure Cooker Test) | +121°C, 100%RH, 2atm, 24 up to 168 hrs. EIA/JEDEC, JESD22-A-102  |
| Resistance to Solder Heat        | +260°C, 30 secs. MIL-STD-750 (Method 2031)   |
| Moisture Sensitivity Level       | 85%RH, +85°C, 168 hrs., 3 reflow cycles (+260°C Peak). JEDEC-J-STD-020, Level 1  |

### Part Numbering

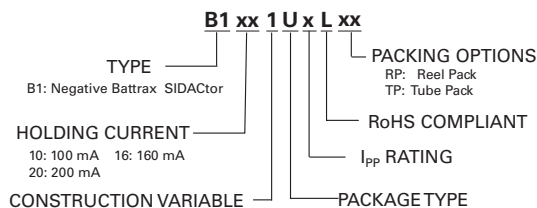

### Part Marking

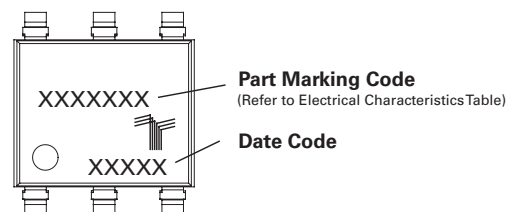

**Dimensions — MS-013**

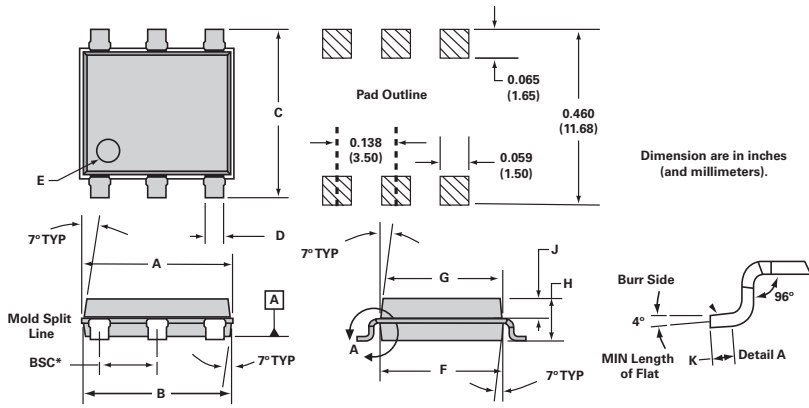

| Dimensions  | Inches |       | Millimeters |       |
|-------------|--------|-------|-------------|-------|
|             | Min    | Max   | Min         | Max   |
| <b>A</b>    | 0.360  | 0.364 | 9.14        | 9.25  |
| <b>B</b>    | 0.352  | 0.356 | 8.94        | 9.04  |
| <b>C</b>    | 0.400  | 0.412 | 10.16       | 10.46 |
| <b>D</b>    | 0.043  | 0.045 | 1.09        | 1.13  |
| <b>E</b>    | 0.047  | 0.055 | 1.19        | 1.40  |
| <b>F</b>    | 0.293  | 0.297 | 7.44        | 7.54  |
| <b>G</b>    | 0.289  | 0.293 | 7.34        | 7.44  |
| <b>H</b>    | 0.089  | 0.093 | 2.26        | 2.36  |
| <b>J</b>    | 0.041  | 0.049 | 1.04        | 1.24  |
| <b>K</b>    | 0.020  | 0.020 | 0.51        | 0.51  |
| <b>BSC*</b> | 0.133  | 0.143 | 3.38        | 3.63  |

\* BSC = Basic Spacing between Centers

**Packing Options**

| Package Type | Description                              | Quantity             | Added Suffix | Industry Standard |
|--------------|--|----------------------|--------------|-------------------|
| U            | Modified MS-013 6-pin Tape and Reel Pack | 1500                 | RP           | EIA-481-D         |
|              | Modified MS-013 6-pin Tube Pack          | 500<br>(50 per tube) | TP           | N/A               |

**Tape and Reel Specification — MS-013**

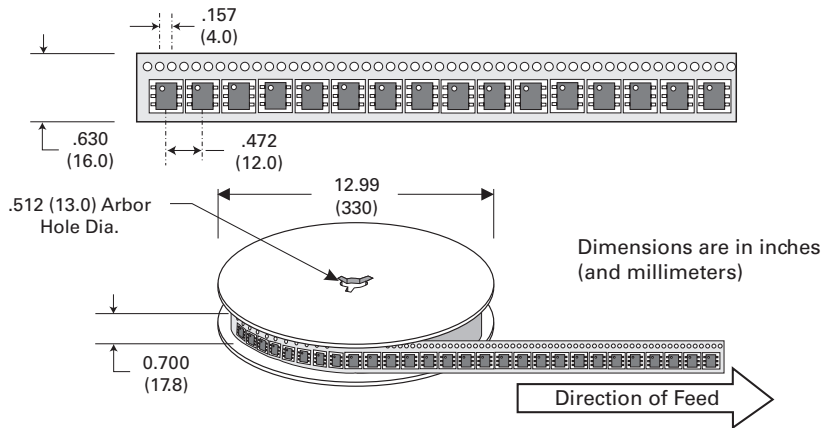

**Tube Pack Specification — MS-013**

