

Small Signal Transistor

SOT-23

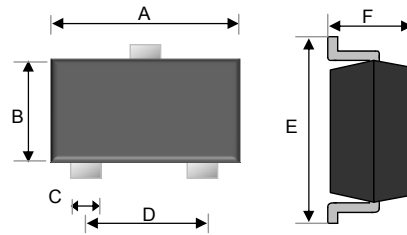
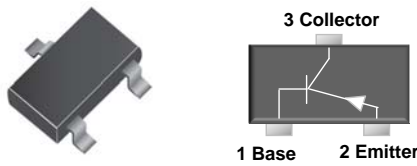

Features

- ✧ Epitaxial planar die construction
- ✧ Surface device type mounting
- ✧ Moisture sensitivity level 1
- ✧ Matte Tin(Sn) lead finish with Nickel(Ni) underplate
- ✧ Pb free version and RoHS compliant
- ✧ Green compound (Halogen free) with suffix "G" on packing code and prefix "G" on date code

Mechanical Data

- ✧ Case : SOT- 23 small outline plastic package
- ✧ Terminal: Matte tin plated, lead free., solderable per MIL-STD-202, Method 208 guaranteed
- ✧ High temperature soldering guaranteed: 260°C/10s
- ✧ Weight : 0.008gram (approximately)

Dimensions	Unit (mm)		Unit (inch)	
	Min	Max	Min	Max
A	2.80	3.00	0.110	0.118
B	1.20	1.40	0.047	0.055
C	0.30	0.50	0.012	0.020
D	1.80	2.00	0.071	0.079
E	2.25	2.55	0.089	0.100
F	0.90	1.20	0.035	0.043

Ordering Information

Package	Part No.	Packing	Marking
SOT-23	BC856A RF	3K / 7" Reel	3A
SOT-23	BC856B RF	3K / 7" Reel	3B
SOT-23	BC857A RF	3K / 7" Reel	3E
SOT-23	BC857B RF	3K / 7" Reel	3F
SOT-23	BC857C RF	3K / 7" Reel	3G
SOT-23	BC858A RF	3K / 7" Reel	3J
SOT-23	BC858B RF	3K / 7" Reel	3K
SOT-23	BC858C RF	3K / 7" Reel	3L
SOT-23	BC856A RFG	3K / 7" Reel	3A
SOT-23	BC856B RFG	3K / 7" Reel	3B
SOT-23	BC857A RFG	3K / 7" Reel	3E
SOT-23	BC857B RFG	3K / 7" Reel	3F
SOT-23	BC857C RFG	3K / 7" Reel	3G
SOT-23	BC858A RFG	3K / 7" Reel	3J
SOT-23	BC858B RFG	3K / 7" Reel	3K
SOT-23	BC858C RFG	3K / 7" Reel	3L

Suggested PAD Layout

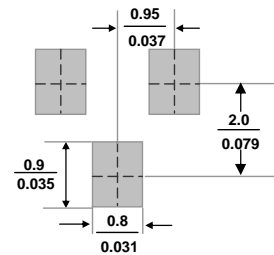

Maximum Ratings and Electrical Characteristics

Rating at 25°C ambient temperature unless otherwise specified.

Maximum Ratings

Type Number	Symbol	Value	Units
Power Dissipation	P_D	250	mW
Collector-Base Voltage	V_{CBO}	BC856	-80
		BC857	-50
		BC858	-30
Collector-Emitter Voltage	V_{CEO}	BC856	-65
		BC857	-45
		BC858	-30
Emitter-Base Voltage	V_{EBO}	-5	V
Collector Current	I_C	-0.1	A
Junction and Storage Temperature Range	T_J, T_{STG}	-55 to + 150	°C

Notes:1. Valid provided that electrodes are kept at ambient temperature

Small Signal Transistor
Electrical Characteristics

Type Number	Symbol	Min	Max	Units
Collector-Base Breakdown Voltage	$V_{(BR)CBO}$	-80 -50 -30	-	V
Collector-Emitter Breakdown Voltage	$V_{(BR)CEO}$	-65 -45 -30	-	V
Emitter-Base Breakdown Voltage	$V_{(BR)EBO}$	-5	-	V
Collector Cut-off Current	I_{CBO}	-	-15	nA
Emitter Cut-off Current	I_{EBO}	-	-0.1	μ A
DC current gain	h_{FE}	125 220 420	250 475 800	
Collector-Emitter saturation voltage	$V_{CE(sat)}$	-	-0.65	V
Base-Emitter saturation voltage	$V_{BE(sat)}$	-	-1.1	V
Transition frequency	f_T	100	-	MHz

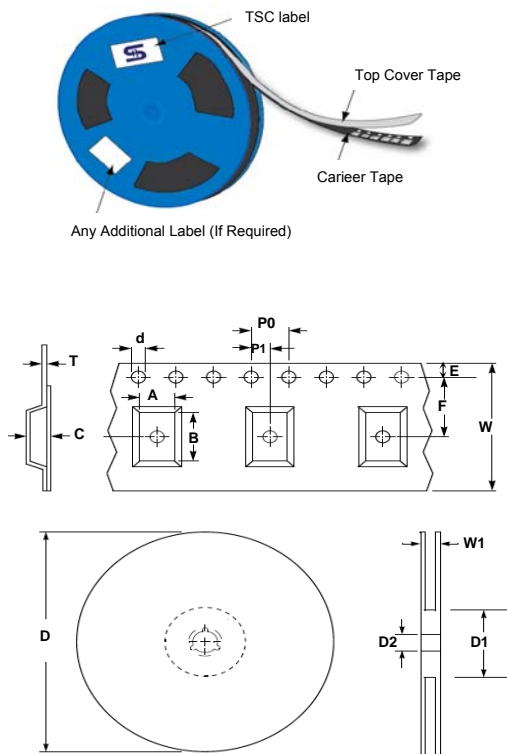
Tape & Reel specification

Item	Symbol	Dimension(mm)
Carrier width	A	3.15 ±0.10
Carrier length	B	2.77 ±0.10
Carrier depth	C	1.22 ±0.10
Sprocket hole	d	1.50 ± 0.10
Reel outside diameter	D	178 ± 1
Reel inner diameter	D1	55 Min
Feed hole width	D2	13.0 ± 0.20
Sprocket hole position	E	1.75 ±0.10
Punch hole position	F	3.50 ±0.05
Sprocket hole pitch	P0	4.00 ±0.10
Embossment center	P1	2.00 ±0.05
Overall tape thickness	T	0.229 ±0.013
Tape width	W	8.10 ±0.20
Reel width	W1	12.30 ±0.20

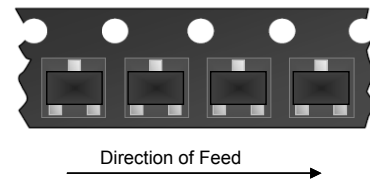

Small Signal Transistor

Rating and Characteristic Curves

Figure 1. Static Characteristic

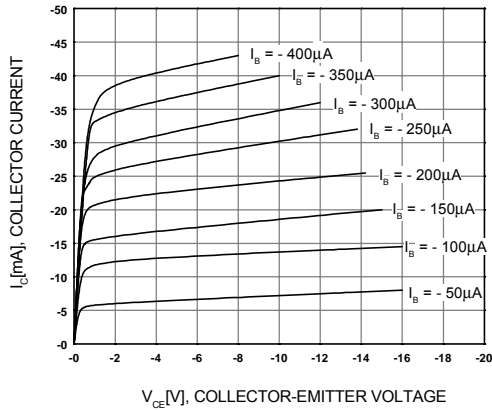

Figure 2. DC Current Gain

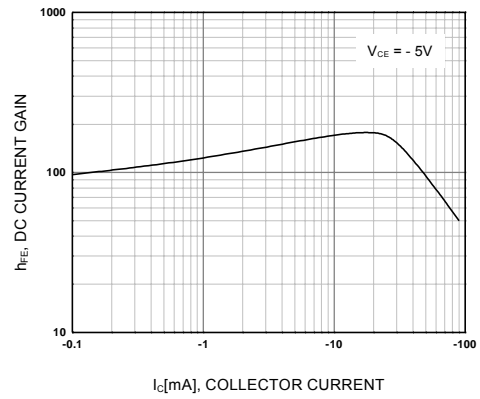

Figure 3. Base-Emitter Saturation Voltage
 Collector-Emitter Saturation

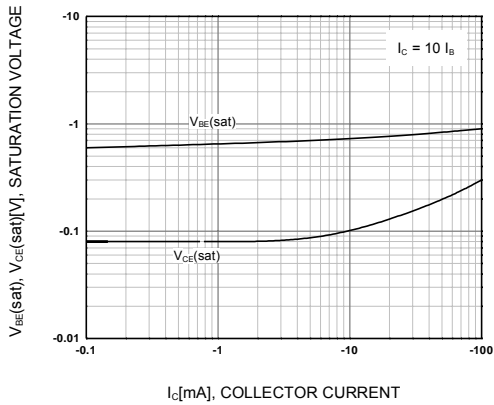

Figure 4. Base-Emitter On Voltage

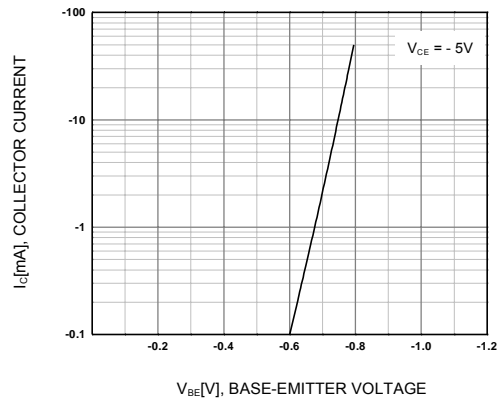

Figure 5. Collector Output Capacitance

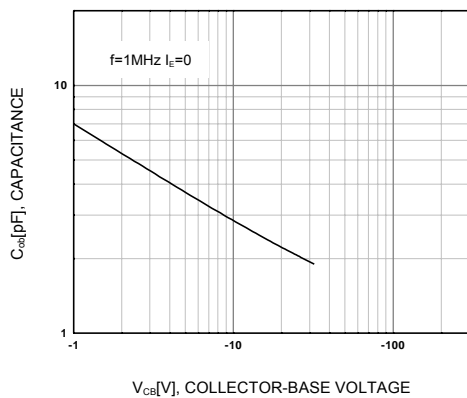
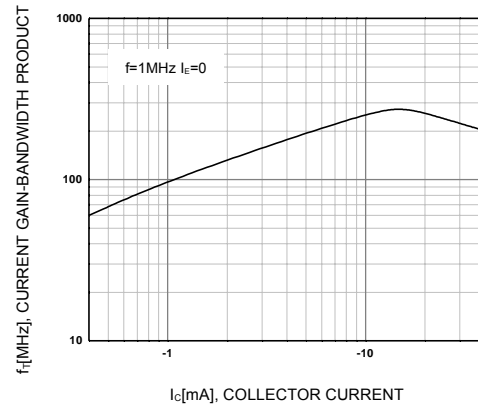

Figure 6. Current Gain Bandwidth Product



Small Signal Transistor

Rating and Characteristic Curves

Figure 7. DC current gain as a function of collector current; typical values

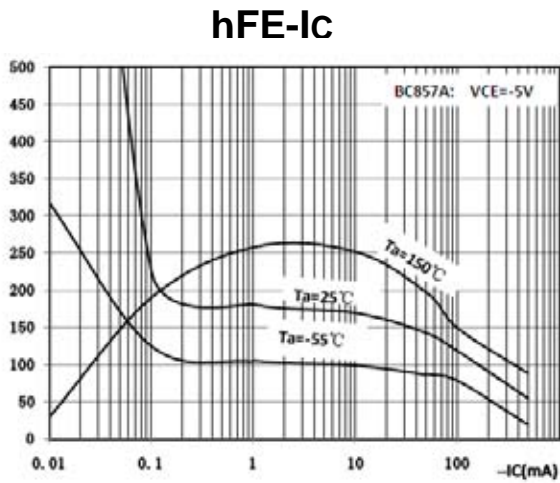

Figure 8. Base-emitter voltage as a function of collector current; typical values

