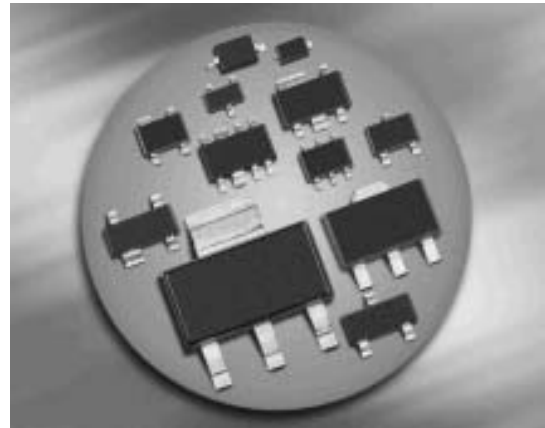
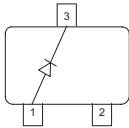
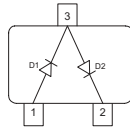
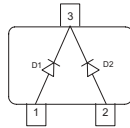
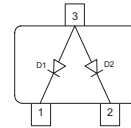
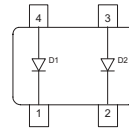

**Silicon Schottky Diode**

- For mixer applications in VHF/UHF range
- For high-speed switching application
- Pb-free (RoHS compliant) package<sup>1)</sup>
- Qualified according AEC Q101

**BAT17**

**BAT17-04  
BAT17-04W**

**BAT17-05  
BAT17-05W**

**BAT17-06W**

**BAT17-07**

**ESD (Electrostatic discharge) sensitive device, observe handling precaution!**

Type	Package	Configuration	$L_S$ (nH)	Marking
BAT17	SOT23	single	1.8	53s
BAT17-04	SOT23	series	1.8	54s
BAT17-04W	SOT323	series	1.4	54s
BAT17-05	SOT23	common cathode	1.8	55s
BAT17-05W	SOT323	common cathode	1.4	55s
BAT17-06W	SOT323	common anode	1.4	56s
BAT17-07	SOT143	parallel pair	2	57s

<sup>1</sup>Pb-containing package may be available upon special request

**Maximum Ratings at  $T_A = 25^\circ\text{C}$ , unless otherwise specified**

Parameter	Symbol	Value	Unit
Diode reverse voltage	$V_R$	4	V
Forward current	$I_F$	130	mA
Total power dissipation	$P_{\text{tot}}$		mW
BAT17, $T_S \leq 77^\circ\text{C}$		150	
BAT17-04, $T_S \leq 61^\circ\text{C}$		150	
BAT17-05, $T_S \leq 46^\circ\text{C}$		150	
BAT17-04W, -05W, -6W, $T_S \leq 92^\circ\text{C}$		150	
BAT17-07, $T_S \leq 60^\circ\text{C}$		150	
Junction temperature	$T_j$	150	°C
Operating temperature range	$T_{\text{op}}$	-55 ... 125	
Storage temperature	$T_{\text{stg}}$	-55 ... 150	

**Thermal Resistance**

Parameter	Symbol	Value	Unit
Junction - soldering point <sup>1)</sup>	$R_{\text{thJS}}$		K/W
BAT17		$\leq 490$	
BAT17-04, BAT17-07		$\leq 590$	
BAT17-05		$\leq 690$	
BAT17-04W, BAT17-05W, BAT17-06W		$\leq 390$	

<sup>1</sup>For calculation of  $R_{\text{thJA}}$  please refer to Application Note Thermal Resistance

**Electrical Characteristics** at  $T_A = 25^\circ\text{C}$ , unless otherwise specified

Parameter	Symbol	Values			Unit
		min.	typ.	max.	
<b>DC Characteristics</b>					
Breakdown voltage $I_{(BR)} = 10 \mu\text{A}$	$V_{(BR)}$	4	-	-	V
Reverse current $V_R = 3 \text{ V}$ $V_R = 4 \text{ V}$ $V_R = 3 \text{ V}, T_A = 60^\circ\text{C}$	$I_R$	-	-	0.25 10 1.25	$\mu\text{A}$
Forward voltage $I_F = 0.1 \text{ mA}$ $I_F = 1 \text{ mA}$ $I_F = 10 \text{ mA}$	$V_F$	200 250 350	275 340 425	350 450 600	mV
Forward voltage matching <sup>1)</sup> $I_F = 1 \text{ mA}$	$\Delta V_F$	-	-	20	
<b>AC Characteristics</b>					
Diode capacitance $V_R = 0, f = 1 \text{ MHz}$	$C_T$	0.4	0.55	0.75	pF
Differential forward resistance $I_F = 5 \text{ mA}, f = 10 \text{ kHz}$	$R_F$	-	8	15	$\Omega$

<sup>1)</sup> $\Delta V_F$  is the difference between lowest and highest  $V_F$  in multiple diode component.

**Diode capacitance  $C_T = f(V_R)$**

$f = 1\text{MHz}$

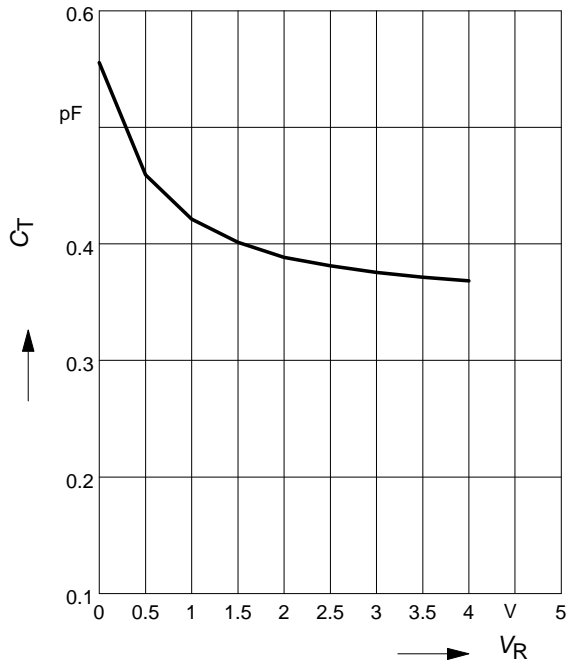

**Forward resistance  $r_f = f(I_F)$**

$f = 10\text{kHz}$

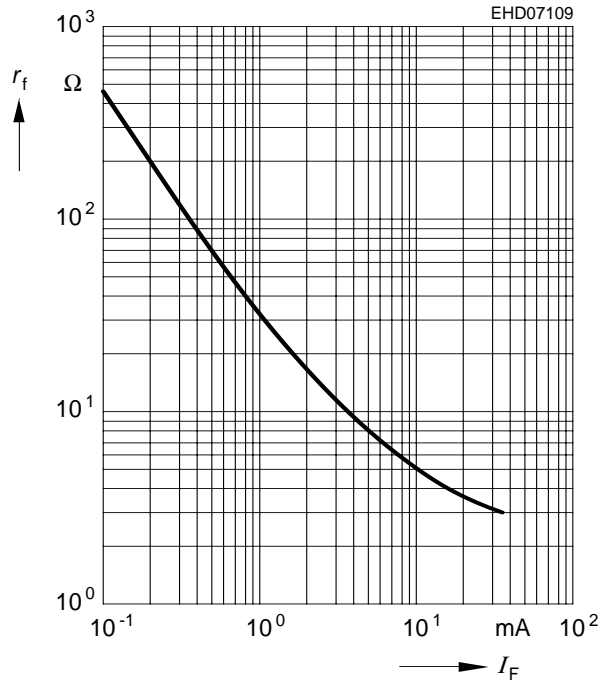

**Reverse current  $I_R = f(V_R)$**

$T_A = \text{Parameter}$

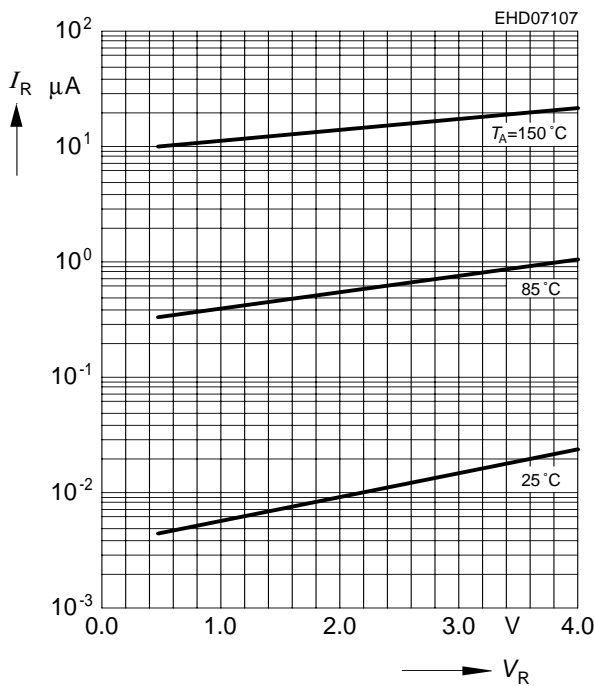

**Forward current  $I_F = f(V_F)$**

$T_A = \text{Parameter}$

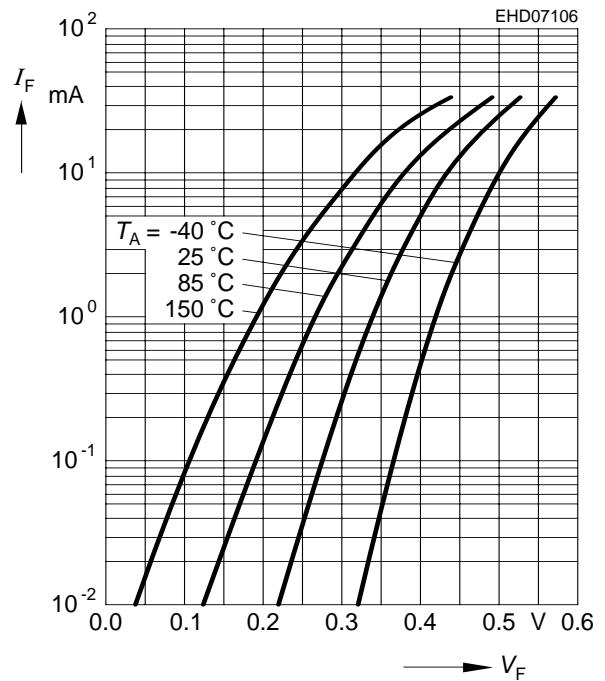

**Forward current  $I_F = f(T_S)$**

BAT17

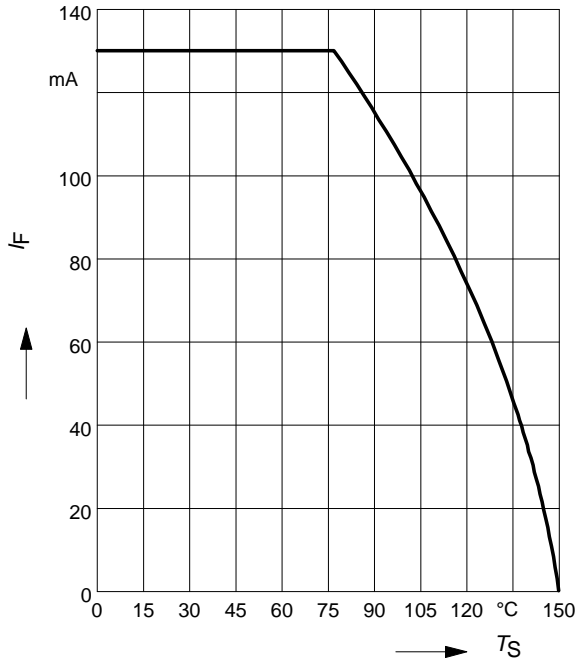

**Forward current  $I_F = f(T_S)$**

BAT17-04, BAT17-07

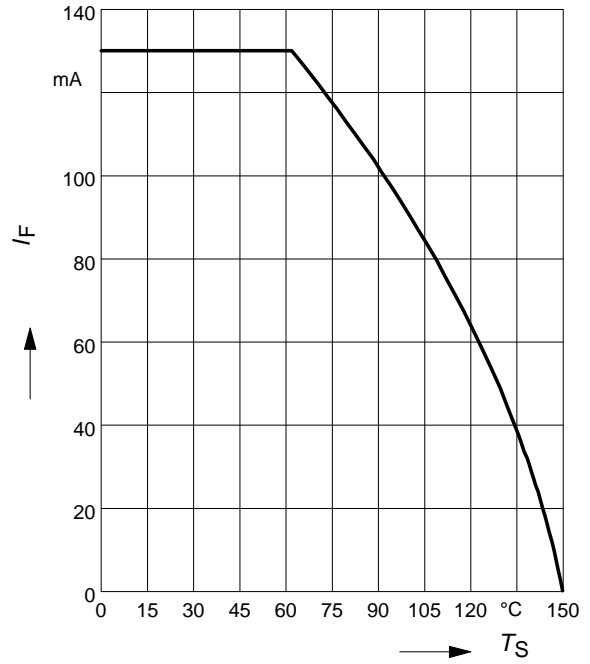

**Forward current  $I_F = f(T_S)$**

BAT17-05

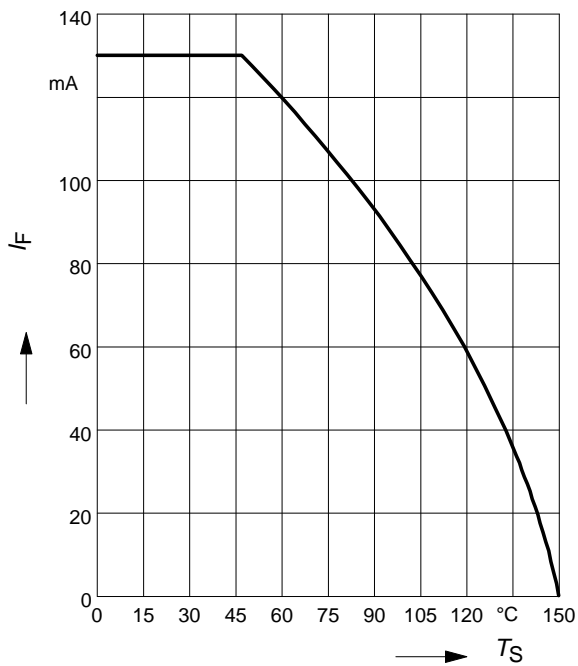

Package Outline

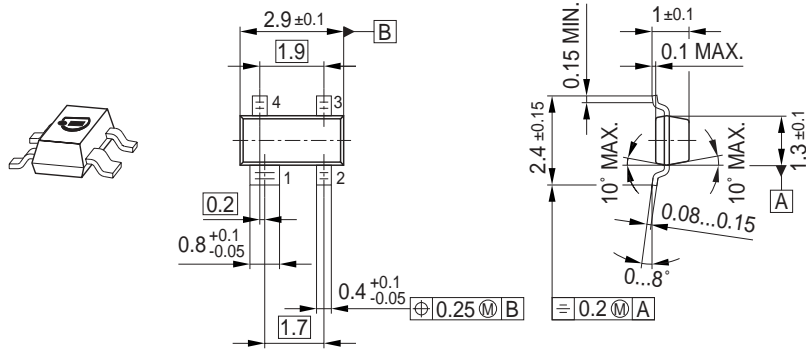

Foot Print

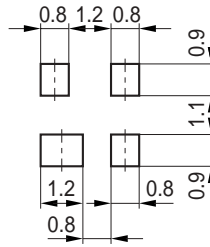

Marking Layout (Example)

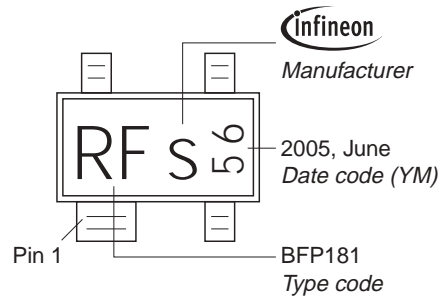

Standard Packing

Reel  $\varnothing 180$  mm = 3.000 Pieces/Reel  
 Reel  $\varnothing 330$  mm = 10.000 Pieces/Reel

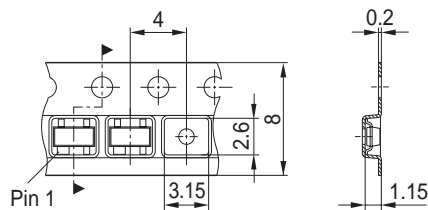

Package Outline

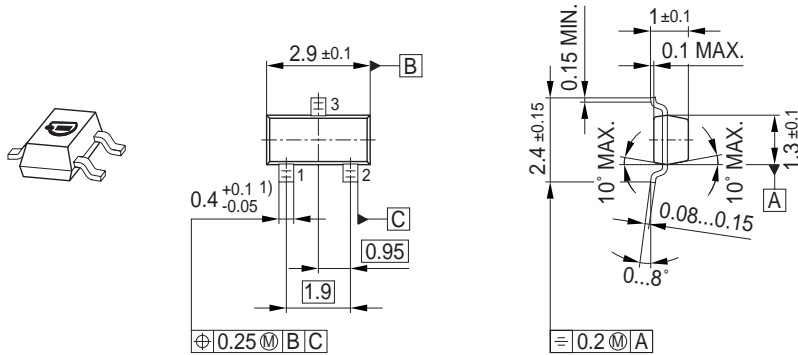

1) Lead width can be 0.6 max. in dambar area

Foot Print

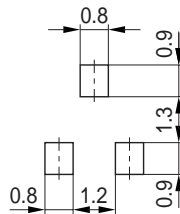

Marking Layout (Example)

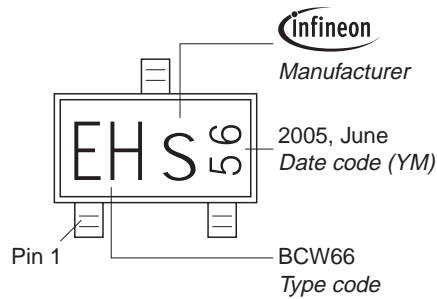

Standard Packing

Reel ø180 mm = 3.000 Pieces/Reel  
 Reel ø330 mm = 10.000 Pieces/Reel

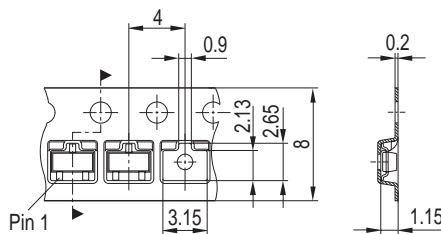

Package Outline

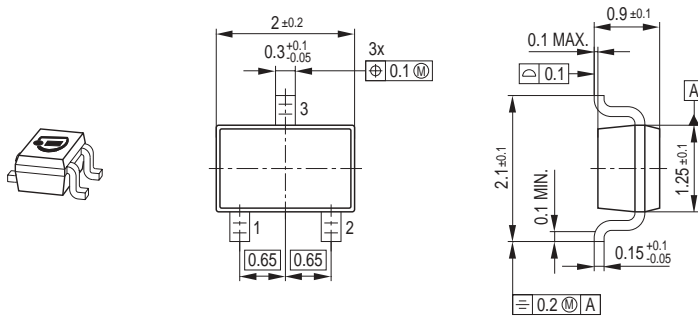

Foot Print

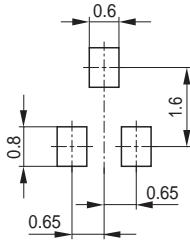

Marking Layout (Example)

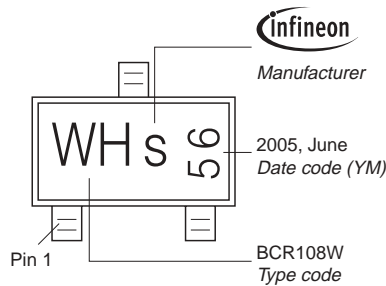

Standard Packing

Reel  $\varnothing 180 \text{ mm} = 3.000 \text{ Pieces/Reel}$   
 Reel  $\varnothing 330 \text{ mm} = 10.000 \text{ Pieces/Reel}$

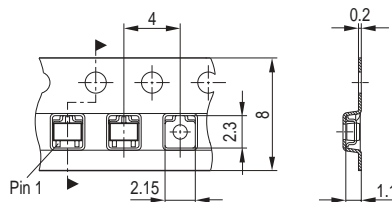



Edition 2006-02-01  
Published by  
Infineon Technologies AG  
81726 München, Germany  
© Infineon Technologies AG 2007.  
All Rights Reserved.

### **Attention please!**

The information given in this dokument shall in no event be regarded as a guarantee of conditions or characteristics ("Beschaffenhheitsgarantie"). With respect to any examples or hints given herein, any typical values stated herein and/or any information regarding the application of the device, Infineon Technologies hereby disclaims any and all warranties and liabilities of any kind, including without limitation warranties of non-infringement of intellectual property rights of any third party.

### **Information**

For further information on technology, delivery terms and conditions and prices please contact your nearest Infineon Technologies Office ([www.infineon.com](http://www.infineon.com)).

### **Warnings**

Due to technical requirements components may contain dangerous substances. For information on the types in question please contact your nearest Infineon Technologies Office.

Infineon Technologies Components may only be used in life-support devices or systems with the express written approval of Infineon Technologies, if a failure of such components can reasonably be expected to cause the failure of that life-support device or system, or to affect the safety or effectiveness of that device or system.

Life support devices or systems are intended to be implanted in the human body, or to support and/or maintain and sustain and/or protect human life. If they fail, it is reasonable to assume that the health of the user or other persons may be endangered.